

# Sparks, shocks and voltage traces as winwods into experience : the spiral conductor and star wheel interrupter of Charles Grafton Page

Autor(en): **Cavicchi, Elizabeth**

Objektyp: **Article**

Zeitschrift: **Archives des sciences [2004-ff.]**

Band (Jahr): **58 (2005)**

Heft 2

PDF erstellt am: **22.07.2024**

Persistenter Link: <https://doi.org/10.5169/seals-738397>

## **Nutzungsbedingungen**

Die ETH-Bibliothek ist Anbieterin der digitalisierten Zeitschriften. Sie besitzt keine Urheberrechte an den Inhalten der Zeitschriften. Die Rechte liegen in der Regel bei den Herausgebern.

Die auf der Plattform e-periodica veröffentlichten Dokumente stehen für nicht-kommerzielle Zwecke in Lehre und Forschung sowie für die private Nutzung frei zur Verfügung. Einzelne Dateien oder Ausdrucke aus diesem Angebot können zusammen mit diesen Nutzungsbedingungen und den korrekten Herkunftsbezeichnungen weitergegeben werden.

Das Veröffentlichen von Bildern in Print- und Online-Publikationen ist nur mit vorheriger Genehmigung der Rechteinhaber erlaubt. Die systematische Speicherung von Teilen des elektronischen Angebots auf anderen Servern bedarf ebenfalls des schriftlichen Einverständnisses der Rechteinhaber.

## **Haftungsausschluss**

Alle Angaben erfolgen ohne Gewähr für Vollständigkeit oder Richtigkeit. Es wird keine Haftung übernommen für Schäden durch die Verwendung von Informationen aus diesem Online-Angebot oder durch das Fehlen von Informationen. Dies gilt auch für Inhalte Dritter, die über dieses Angebot zugänglich sind.

# Sparks, Shocks and Voltage Traces as Windows into Experience:

## The Spiraled Conductor and Star Wheel Interrupter of Charles Grafton Page

Elizabeth CAVICCHI<sup>a</sup>

### ■ Abstract

*When battery current flowing in his homemade spiraled conductor switched off, nineteenth century experimenter Charles Grafton Page saw sparks and felt shocks, even in parts of the spiral where no current passed. Reproducing his experiment today is improvisational: an oscilloscope replaces Page's body; a copper star spinning through galinstan substitutes for Barlow's wheel interrupter. Green and purple flashes accompanied my spinning wheel. Unlike what Page's shocks showed, induced voltages probed across my spiral's wider spans were variable, precipitating extensive explorations of its resonant frequencies. Redoing historical experiments extends our experience, fostering new observations about natural phenomena and experimental development.*

**Keywords:** electromagnetic induction, historical replication, Charles Grafton Page, exploratory learning, spiral, Barlow wheel, galinstan, autotransformer

### ■ Introduction

Historical experiments come to us in fragments: handwritten data, published reports, and often non-functioning apparatus. A further carry-over may persist in ideas, procedures, materials and inventions bearing imprints of the prior work. All these are clues to something both more transitory and more coherent than the historical record: the original experience of an investigation. An experiment's findings may be summed up succinctly, but its experience is multifarious, a dynamic weaving of action and thought. While no co-participant tells the same story, the experience is of a whole, integrated together by the questions and phenomena (Dewey 1934).

Looking into someone else's past experience is provocative for taking up our own. What is it like, not just to read, for example that Oersted's compass was affected by nearby currents (1820), but to try it for

real? Facing wires and wiggling magnetic needles firsthand, while trying to make sense of it, deepens our perspective; we become confused and curious (Cavicchi 2003). Redoing an experiment is not just a check on facts, dates, whether Oersted's needle went east or west. It gives us access to experience congruous with the past: "to know an experimenter, you should replicate her study" (Kurz 2001, p. 180).

Redoing historical science experiments while doing history of science is a new means of scholarship where the researcher's experience comes into view, instead of hiding in footnotes and credits. This experience has to stay in view because that is where creative work goes on: observing, inferring, questioning and opening up further experience. And the findings of these studies animate past experience in ways not reachable by textual analyses alone. Working with many motions along experimental paths that seem diverging until the researcher tries them out, Galileo

<sup>a</sup> Edgerton Center, MIT, Cambridge MA - Elizabeth\_cavicchi@post.harvard.edu

developed experiences by which coherent properties of motion became intelligible (Settle 1996). Streaming in the dark along grounded surfaces placed in the way of an electrostatic generator, luminosity lets us see how fully visual was French natural philosopher Jean Paul Marat's engagement with electrical fluid (Heering 2002). A ruby-colored precipitate found in the wash-water left from making gold films became a touchstone for reconstructing how Faraday sorted out whether the films were particulate or not (Tweney 2006). A weight swinging on a string, a dark room, wet hands: these remind us how materials in action, spatial surroundings, and our bodies are inextricable to experience – with its thoughtful creations – then and now,

Materials of copper and fabric, the space curled within a spiral, and the experimenter's body were circuitally united in the nineteenth century electrical experiment described here alongside my reconstructive counterpart. Unexpected paths of electricity's heightened reaction to an opening of the circuit's switch surprised the original experimenter by a most acute means: human shock. Those paths are still to be observed today, although hand-to-hand shocks are now proscribed, along with other health hazards once routine in lab environments. For me, getting into the experience of constructing and observing a spiraled conductor by different means was like looking into a scene by a different window, where perspectives and relations seem shifted, partly incongruous. Yet, as Piaget and Inhelder demonstrated with children (1948), through working out the relations between differing perspectives, more operational understandings of the whole become available. Stepping through windows that may change from spark to shock to graphical display brings historical and present experiences into view. Both their connections and differences show how much more still remains for us to explore.

### Background and description of Page's spiral apparatus

Science activities of early nineteenth century America were not defined by professionalism and established traditions, being loosely clumped around small collections, libraries and instruction adapted from European sources (Greene 1984). The experiment revisited here breaks upon this dormant scene with the exuberance of a novice. Abundant findings result from the recently entered terrain, while the innovative means of experimenting open yet further the possibilities for noticing something new.

The novel phenomena involved heightened electricity detected everywhere, and anywhere, within a spiraled conductor whenever battery current was

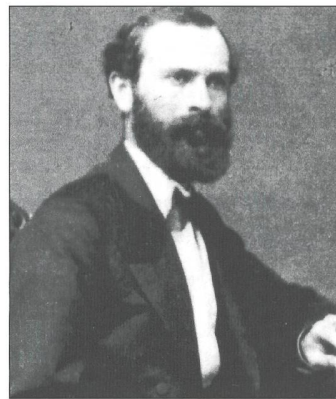

Fig. 1. Charles Grafton Page (1812-1878).

stopped from traversing any portion of the spiral (Page 1837a). These two observations – the momentary effect and its heightened intensity – characterize electromagnetic induction.

Originally researched by Michael Faraday (1831), it became foundational for nineteenth century technologies such as telegraphy and dynamos.

The American observing the inductive spiral, was Charles Grafton Page (1812-1878; Fig. 1). Page came to have a long career innovating devices and understandings of electromagnetic behaviors (Post 1974). At the time, he was completing medical studies at Harvard and still living at his parents' home in Salem Massachusetts. Fascination with electricity originating in boyhood pranks and gadgetry (Lane 1869) led to Page's first published invention: a glass piston displaying electrostatic sparking on its upward stroke (Page 1833). A cursory account about a spiral conductor's unusual action in delivering strong shocks, hurried into print by Princeton professor Joseph Henry (1835) to stake out a priority claim against Faraday (1834), provoked Page to construct a spiral of his own. In replicating Henry's apparatus, he took the experimental work further, and learned something new. Whereas Henry found that a spiral put in series with a battery enhanced the shocks induced in the circuit, Page discovered that even if a small portion of the spiral carried battery current, induced shocks could be felt – even more strongly – throughout the whole spiral, even beyond the direct current's path.

Page's report, occupying four printed pages with one diagram, is concise. It describes his apparatus and a multitude of observations made with it (1837a). A few additional details appear in a paper written after he extended the spiral's length (Page 1837b), and in a document crafted thirty years later to secure his priority as an inventor of the induction coil (Page 1867). At the time, Page's attention diverted to electromagnetic coils, neglecting spiral geometries. Spiral conductors became commercially available from Page's collaborator<sup>1</sup>, the Boston instrument-

<sup>1</sup> Page's collaboration with Daniel Davis junior is discussed in Sherman 1988.



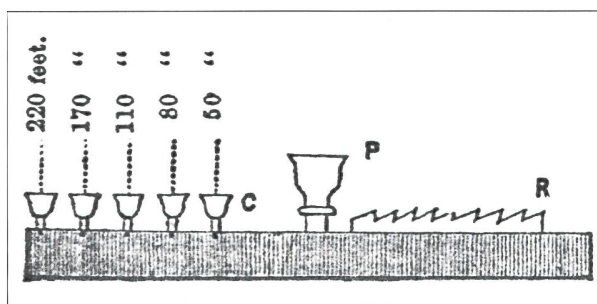

Fig. 2. Edge view of spiral with connector cups and rasp interrupter (Page 1867).

maker Daniel Davis junior (1838, 1842). While spiral conductors used by Henry, and made by Davis, survive in some instrument collections<sup>2</sup>, their design was influenced by Henry, not Page.

As Page tells it, his spiral was homemade, bulky, cobbled together from copper sheet, solder and cloth. Four 55 foot strips of copper, soldered end-to-end to make up a 220 foot length were spiraled up with fabric wrapping to insulate one copper turn from the next. Each of these four strips was not a true two-dimensional ribbon. Page had access to copper only in the form of a rectangular sheet. By cleverly cutting long slits alternately into opposite sides of the sheet,

<sup>2</sup> The National Museum of American History, Smithsonian Institution, Washington DC, holds several spiral conductors used by Joseph Henry; the Historical Collection of Scientific Instruments at Harvard University includes spirals made by Daniel Davis junior.

<sup>3</sup> A phrase from Page's paper's title, "Prof. Henry's apparatus for obtaining sparks and shocks from the Calorimotor", raises the question of whether Page modeled his battery on Henry's. Henry's brief account alludes to a great calorimotor having "about forty feet of zinc surface" (Henry, 1837, p. 330). This stupendous battery of eight-eight galvanic pairs used by Henry was built and tested by 1835. However, its description appeared in print only after Page's experiment was underway (Henry 1837). The original calorimotor of Robert Hare (1818) was a similarly massive assembly of twenty large pairs that lowered by hoist into acid. It is more likely that instead of referring to either landmark instrument, the student Page working at home, used the word "calorimotor" generically, as having closely spaced large surfaces of zinc and copper. While the undergraduate text from which he studied (Webster 1828, para 290; see Post 1976 for Page's undergraduate studies) used the word "calorimotor" only in the context of Hare's construction, the next edition of the textbook used it generically (Webster 1839). This inference is confirmed by a passage written at the end of his life, where Page asserted that "only simple batteries, that is single pairs of different sizes" were used with the spiral (Page 1867, p. 13).

<sup>4</sup> British experimenter Peter Barlow described his homemade battery as "the calorimotor of Dr. Hare which I had made of the plates of my old battery, 20 of zinc, and 20 of copper, each 10 inches square" (1828, p. 241).

then pulling on that sheet's opposite corners, Page stretched out a zig-zag of copper. He converted the zig-zag into a strip by bending each copper segment into line with the forgoing length. In this way, Page reduced the number of potentially fallible solder joints just to what was needed to combine the four strips.

At the copper spiral's two ends, and in between at unequal intervals of either 30 or 50 feet, Page soldered copper strips for making connections. These connector strips extended through openings in the lid of a wood box which housed the long spiral. They terminated in thimble cups containing liquid mercury. Manually dipping wire in or out of the mercury cups made or broke electrical continuity between the spiral, the battery, and other circuital elements. The central cup, which joined to the spiral's inner end, was a clear glass vessel, larger than the thimbles. This glass facilitated seeing the sparks, and had space for layering water over the mercury, which suppressed these sparks (Page, 1867; Fig. 2).

A "calorimotor" capable of putting out high currents activated the spiral. Page's compact text divulges little about the battery he actually used, other than that removing and cleaning its zinc plates improved function (1837a, p. 141)<sup>3</sup>. A calorimotor was a battery having large plates of copper and zinc opposing each other in acid and closely spaced or even coiled around each other<sup>4</sup>. As a single large cell, it could produce high currents (and concurrent heating, or caloric, effects) at low voltage.

The connector cups were distinctive in making Page's spiral into an instrument of exploratory research. Their placement at intermediate positions along the

Fig. 3. Barlow's star wheel with liquid mercury trough and horseshoe magnet (1822).

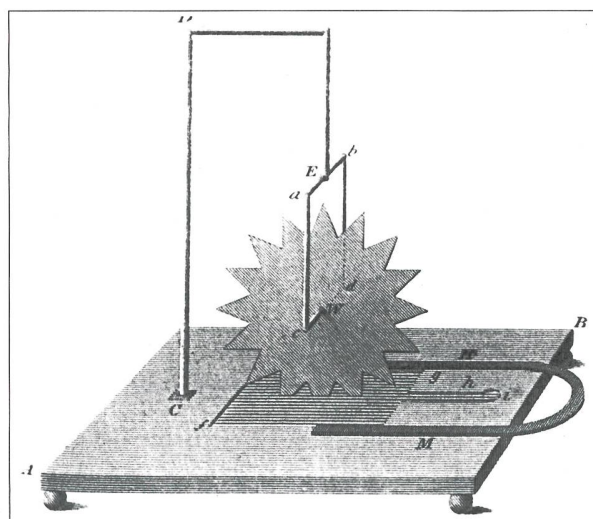



spiral allowed for looking into what went on along differing electrical paths inside the turns. Page took advantage of this flexibility by trying out novel paths running through the spiral and the external apparatus. By contrast, with Henry's spiral and Davis' commercial one, experimental access was limited to the one path running between the inner and outer termini.

While the cups provided connections for multiple electrical paths, they were not the sole means of closing or opening the circuit. Immersing wire into a cup's mercury by hand was slow and necessitated an assistant. To work around these impediments, Page often left the connecting wires in their cups, and invented separate switching devices to insert in the circuit between the battery and the central spiral cup. For example, by joining a steel rasp directly to the central cup (Fig. 2) and manually scraping the battery's wire briskly across its pointed teeth, electrical contacts were successively made and broken. The "scintillations" glinting off the rasp were "very beautiful" (1837a, p.140)<sup>5</sup>.

Rapid circuit switching enhances inductive effects, as Page observed when scraping the rasp. Pioneering in eliciting this behavior, he adapted available materials into contact breakers that were manually operated (like the rasp) and others that eliminated the need for an assistant by being self-actuated<sup>6</sup>. Perhaps Page already had on hand in his home workspace, a Barlow star wheel (Barlow 1822), an early motor available from instrument makers (Fig. 3)<sup>7</sup>. The wheel spun under magnetic influence as its points dipped into a mercury puddle, conducting electricity to it from the axle. It could also be turned manually, as Page did by pulling a string wrapped around its axle when his calorimotor was degraded and not up to the task.

Seeing the star wheel in a new way, Page innovated its use to make and break his spiral's circuit. He let only one point at a time dip in the mercury, so that when it spun out, the current briefly stopped. The wheel, never previously used in high voltage conditions, sparked as it spun in Page's circuit:

■ "Very pleasing effects are produced by breaking the circuit with a revolving spur wheel. A little spur wheel of copper is so made, that in revolving, one spur shall leave the mercury before the next touches. In this way, a rapid series of sparks and detonations are obtained." (Page, 1837a, p. 140).

Page's work in constructing the spiral, and adapting apparatus to use with it, was improvisational and ground-breaking at the same time. He acted on ordinary materials in novel ways: stretching flat copper sheet in a long strip, then coiling it up as a space-filling spiral; up-ending seamstress' thimbles as cups for holding mercury and connecting wires; electrifying a woodworker's rasp to make the first linear contact breaker and transforming a motor toy into a continuous breaker of high frequency. The apparatus had plenty of room, for change, for revision, for striking out on paths that could only be glimpsed in the course of ongoing investigation, and were not evident in advance. The apparatus itself, and the ways of its making, made possible the experimenting that followed, with its flexible responses to unexpected electrical effects. And the most responsive component of this test circuit was not metal or liquid, but Page's own body, taking direct shocks and reconfiguring the apparatus to intensify these sensations.

Fig. 4. Unwound spirals of Henry (top) and Page (bottom), with shock handles (HH), battery (B) and Page's numbering of the intermediate tabs (Fleming 1892.)

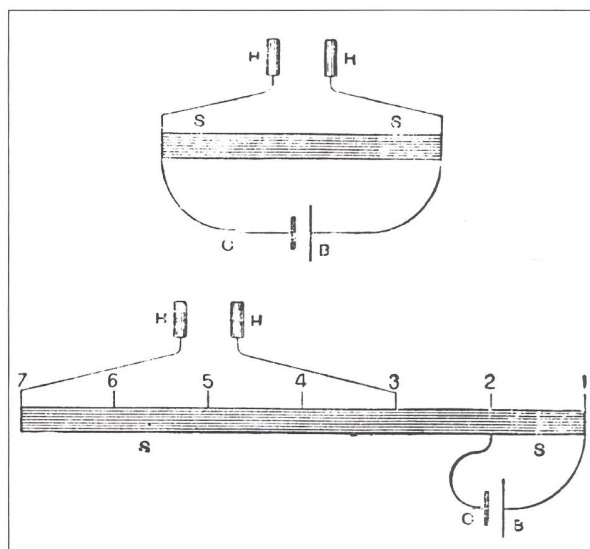

<sup>5</sup> Page's use of a rasp as the contact breaker was original. Daniel Davis Junior took up the practice, installing rasps on his double coils where effects of electromagnetic induction required rapid switching. For examples see Davis trade publications (1838, 1842) and Thomas Greenslade's compilation of original Davis instruments that survive today in college museums and physics departments around the US: <http://www2.kenyon.edu/depts/physics/EarlyApparatus/>

<sup>6</sup> Page's second paper on the spiral introduces several original "vibrating interrupters" (1837b, p. 356).

<sup>7</sup> The Barlow wheel is illustrated in a text by London instrument-maker Francis Watkins (1828), and referenced in Davis' later publications (1838, 1842). Since it ran on low voltage sources, the reports of Barlow (1822) and Watkins (1828) describe only the wheel's motion, and do not say that sparking accompanied the motion.

### ■ Page's experimenting with the spiral

To detect the new electricity arising in the spiral just as its current switched off, Page looked for sparking at disconnection – and took electric shocks through his body. Page's comparative tests of different arrangements of the circuit gave relative, sensational data. Sparks ignited brighter or dimmer in the central glass cup; snaps sounded louder or fainter, shocks felt stronger or weaker.

Page conducted these tests by sending battery current through one part of the spiral, and putting copper handles grasped by each hand across the same part (or a different part) of it. At the instant when an assistant raised the battery wire from the central cup, or scraped the rasp, battery current stopped and Page's body suffered a momentary shock. Joseph Henry's precedent spirals, used in their entirety (Henry 1835), showed only that lengthening the spiral improved shocks. Making use of the intermediate cups, Page let the battery current and his hands span the first interval together (Fig. 4). After feeling the shock of that arrangement, he placed current and hands across the next, and so on up to the entire spiral's length. The felt sensation escalated with each spiral interval: "as the con.[n]nector is raised from these cups successively, the shock increases, and from cup 6 [the last one], is a maximum" (Page, 1837a, p. 138). When just the battery current, without the body<sup>8</sup>, was applied across ever more of the spiral, the visible spark and audible snap peaked about halfway, instead of at full extension.

But "still more curious, and ...difficult to explain" (Page 1836, p. 139) were the sensations Page felt on breaking the passage of battery current through only a portion of the spiral (two or three conjoined intervals) while his hands covered a longer span. He reported more intense shocks – than when the battery current traversed the whole spiral! "Half the coil, with the lateral cooperation of the other half" (p. 139) gave a more potent effect, than the whole.

This finding was neither expected, nor accessible, by Henry's spiral. Page's curiosity to look inside the spiral turns was essential. Something went on interactively within the space of the coiled strip that would

not show up if conductors were electrically stimulated only in their entirety, untapped or uninterrupted.

Yet another possibility was offered by the multiple intermediate positions of the cups: Page's hands could go across any pair of cups. As expected, putting his hands anywhere within the battery current's span, gave shocks. But, in his words "contrary to expectation" (handles at 3 and 7 as in Fig. 4), he also received shocks when the interval between his hands was entirely outside the battery current's direct path. On breaking a battery current that traversed the interval from cups 1 to 3, Page experienced a weak shock between hands placed at cups 4 and 6. Page amplified his sensitivity to these weaker shocks: "by thrusting needles into the thumb and fore finger of the left hand, and immersing the needles in cups 4 and 6, the shock was extremely painful" (1837a, p. 139).

Regarding his fingers pieced by needles<sup>9</sup> as the most sensitive detector around, Page availed himself of the technique again, in addressing a different question. Would he get shocked if his body was in (what we term) series, not in parallel, with the spiral and the battery? Page felt nothing at all: "no shock was felt on making or breaking the circuit". (1837a, p. 140)

These new marvels were visual as well as tactile. The sparking star wheel had its own allure, replete with color, sound, smell and motion:

■ "If bits of silver leaf are hung upon the spurs as the wheel revolves, the combustion of the silver leaf is very vivid, burning with its peculiar emerald light. ...The deflagration of the mercury is extremely vivid, giving copious fumes. If the experiment is performed in a dark room, it exhibits in a superb manner, the well known optical illusion, of a wheel in rapid motion appearing to be at rest. As the wheel is illuminated by a rapid series of sparks, it does not appear to be exactly at rest, but exhibits a quick vibratory movement." (1837a p. 141)

Along with the many concurrent physical effects — glowing and crackling sparks, fuming acids, startling shocks – the experimental experience was diverse as well. Page's hands were immersed in action: cowering copper with cloth; soldering on the cups and plunging connectors into their mercury wells; completing the inductive circuit hand-to-hand through his body – or by needles piercing fingertips; pulling a string to set the star wheel spinning. Imaginative thought was integral with all this handiwork. He continually imagined new permutations among the paths of battery current and shock, checked these circuits, and improved the circuit breaker. Playfulness for tacking silver shards on the star's points, delight with the spinner's shimmy, and intensity of work in the dark were real elements in Page's experience as it developed experimentally.

<sup>8</sup> Page does not explicitly state whether his body was also in the circuit when he compared the brightness of sparks produced across different spiral spans.

<sup>9</sup> Page's needles adapted the French medical technique of "electropuncture", attributed to Jules Cloquet, Jean Baptist Sarlandière and Fabré-Palapat in 1825 (Lu Gwei-Djen 2002). An American discussion of acupuncture as a method of galvanic medicine was read by Robert Peter to the Lexington (KY) Medical Society on December 24 1836.



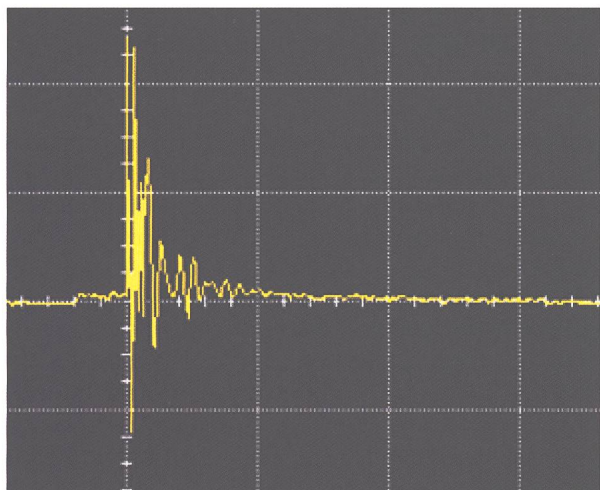

Fig. 5. Oscilloscope screen trace of voltage in time, induced in the spiral when current stops due to breaking connection from liquid metal. Vertical: 200V/div; Horizontal: 5 $\mu$ s/division.

### Setting up apparatus to try Page's experiment in today's lab

My laboratory explorations of Page's work with the spiral originated in curiosity to observe the electrical effects described in his original paper. Like Page, I started out with materials and apparatus readily on hand to me, in the student project lab at MIT's Edgerton Center. Starting from relative inexperience with electrical experimenting, I worked iteratively over several years, putting something together, taking data with it, trying to interpret what happened, and revising my apparatus and research strategy.

The environment for working with electricity in today's lab is very different from Page's day. Today's electrical instrumentation is regulated, distributed, and standardized. Gone are many practices of Page's day, with acids exposed, metal junctions left bare, mercury puddles ubiquitous, sparks darting anywhere, and bodily shocks routinely taken hand-to-hand. No more do sulfuric acid calorimeters power the works, or mercury fumes fill up closed and darkened rooms!

To interpret Page's work now means continually improvising with stand-ins for nineteenth century counterparts. For example, I started with a pair of (D cell) flashlight batteries as a source. When higher currents were needed (to run the spur wheel), I often

resorted to a power supply dial-selectable to a maximum of 5A at 3V. Clip-leads or solder secure electrical connection among insulated wires, copper tabs joined to spiral turns, and the switching apparatus. Sometimes these come apart unnoticed by the hapless experimenter, resulting in a period of sorting out wires and resoldering.

Most irreplaceable of the nineteenth century components, was Page's body. Initially oblivious to this omission, I interpreted the experimental circuit to consist of a spiral conductor, switch, and electrical source in series. I took Page's body to figure as a detector equivalent to a probe having negligible effect on the circuit and connected in parallel across some part of the spiral.

For the sensing of electricity in the circuit – which Page did most often by felt shock – I substituted the detection of voltage. Associating higher voltage with higher shock, I used a high voltage probe to interface with a storage oscilloscope. Transitory high voltage signals induced in the spiral are captured on the oscilloscope screen as a trace of voltage displayed in time (Fig. 5). Each switching event produces a unique trace. I tried to sketch or remember the traces' shapes and ranges of voltage values. As it became confusing to compare traces without plots, I shifted from an analogue to a digital oscilloscope, with which individual traces could be saved as images and as comma-separated variables on disc<sup>10</sup>. By reading this digital data into software packages, it was possible to plot, compare, and analyze the circuit's electrical responses under differing conditions<sup>11</sup>.

Fig. 6. Red: voltage induced across entire spiral when current is switched off. Blue-green: voltage induced on switching off current to the spiral in parallel with a resistor (added to model the human body). Vertical: 50V/div. Horizontal: 5 $\mu$ s/div.

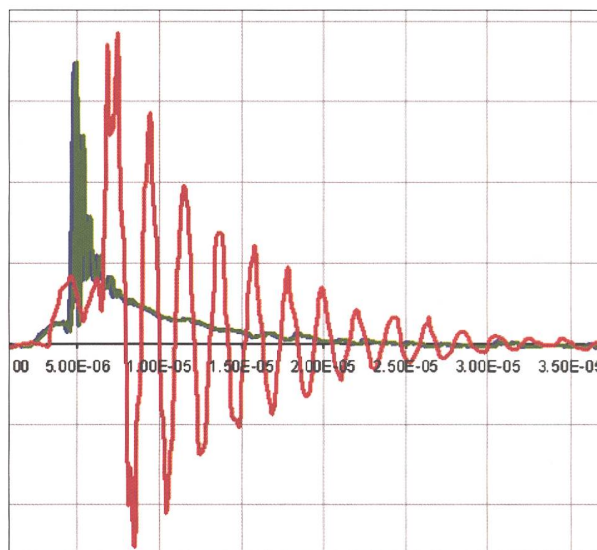

<sup>10</sup> I used analogue oscilloscopes HP 54600B and Lecroy 9450A, and the digital oscilloscope HP Infinium 54810A.

<sup>11</sup> Data was plotted and analyzed with both Excel and MATLAB programs.



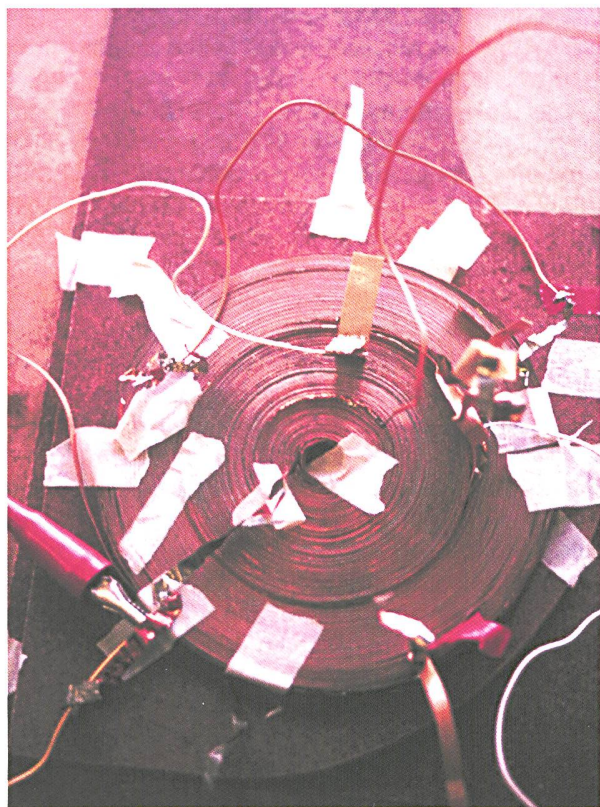

Fig. 7. My spiral, wound from copper tape with soldered wire inserts.

However, as my experimental work stretched on, without clearly demonstrating some of Page's observations, I wondered if his body affected the circuit in ways that were not represented in mine. On trying various electrical substitutes for the human body<sup>12</sup>, connected in parallel with the detector probe, I found the signal damped following the initial peak (Fig. 6). The spiral's overall behavior continued to puzzle me. To study this further, I often reverted to applying the probe alone.

<sup>12</sup> As electrical substitutes for the human body, I tried: resistors of  $330\Omega$  to a high of  $560k\Omega$ ; neon bulbs; a metal-oxide varistor; a resistor in series with a capacitor, and several variations on the model of Siconolfi (1996). This human body model consists of a resistance in series with a capacitance, in parallel with another resistance in series with an inductance. Steven Siconolfi provided data enabling me to construct models. A  $1.87k\Omega$  resistor is in series with a  $2.2nF$  capacitor; this is then in parallel with a  $510\Omega$  resistor and an inductance (of  $27\mu H$  in parallel with  $56\mu H$ ). More extensive empirical and modeling studies of the human body's impedance are provided in Riley 1998.

<sup>13</sup> On one occasion, I ran my prototype Barlow wheel (described below) with mercury instead of galinstan. Surface features differed: mercury droplets flew off the spinning wheel, while galinstan clung to it.

For Page and for me, a spiraled conductor was the centerpiece of the experimental apparatus. Both spirals were improvised by adapting copper from a source that was nontraditional for lab science. Where Page snipped copper stripping out of flat sheet and interwound it with fabric, I spiraled up the paper-backed copper foil tape that stained glass artists use to wrap the edges of glass shapes (Fig. 7). I interpreted the copper tape (having insulating paper separators) as an electrical analogy to Page's cloth-wrapped copper strips. My tape spiral's smaller scale and tighter windings likely improved its responsiveness to the lower currents that are typical of laboratory work today. By contrast, the high currents of Page's calorimotor would have overheated and damaged my fragile assemblies.

At first, I just used the copper tape as-is, by lifting it from its spool and slipping in foil strips at intervals, to make solderless connections. Later, I added more foil tape by spiraling it inward to the center while inserting other connector slips. This configuration made the spiral more evident. Only when tape winds started loosening through use did I solder the connectors in place. Eventually I made other spirals, taking care to wind tightly and evenly, to solder connectors and to watch for faults or interlayer contacts. To one, I added another insulating layer throughout, which proved bulky; to another, I applied rubber paint. Throughout, I treated the spiral as a provisional device, keeping it open to modification.

Just as Page moved from lifting a wire to break the circuit, to rubbing it against a rasp, then to running Barlow's wheel and inventing devices of his own, so also my means of switching continually evolves. By abrading a wood rasp that is hooked to a spiral and battery, a visually beautiful spray of sparks is readily demonstrated. However, I found a mechanical leaf switch more suitable for producing a single high voltage event that could be captured on an analogue oscilloscope. But my experimental options for switching widened to include successive events and periodic electronic switching when I worked with a digital oscilloscope that saves data. Whereas each time a mechanical switch opens, it breaks apart differently when viewed on the fine timescale at which voltages are induced, the periodic waveforms and pulses produced by a frequency generator are nearly similar from one occurrence to the next. By stimulating my spiral with regular pulses and waves having frequencies of different orders of magnitude, I explored its characteristic resonances.

Although the mechanical dipping of Page's wires and wheels into mercury was not an option for this project<sup>13</sup>, I wondered how the interface between wire and liquid metal affected the induced signals. On substi-



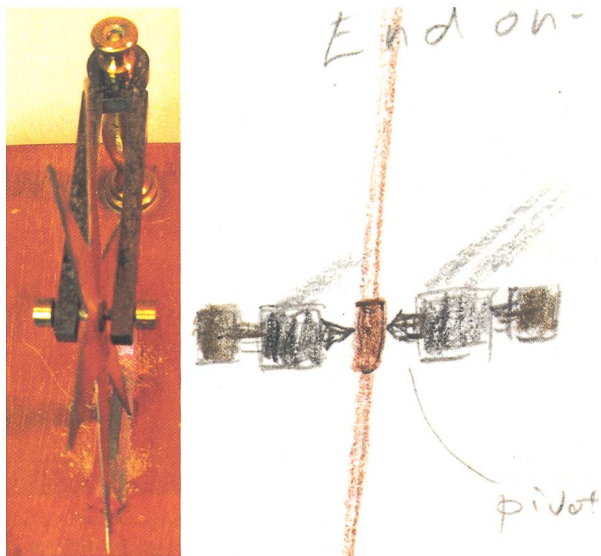

Fig. 8. Edge-on photo and my sketch of mounting of Barlow star wheel between pointed screw tips (Bakken Museum 96.5.3).

tuting a sealed mercury switch for the metal-to-metal contacts, I found the circuit's electrical response was damped. However the sealed switch lacked the open air mercury fragrance so often described in historical accounts. From Peter Heering (see elsewhere this volume), I learned about galinstan, a new gallium alloy which is liquid at room temperature and safe to use<sup>14</sup>. After simply connecting my circuit by poking wires into a galinstan drop to emulate Page's wire in mercury thimbles, I became curious to make a star wheel that would spin through galinstan.

As with the spiral, the star wheel came about by iterative steps, where I made a part, tested it, and revised the working assembly while always keeping the whole maximally adjustable. The star wheel's construction involved me in learning to use milling machines, lathes, and other metal-cutting tools with instructor Fred Cote at the Edgerton Center Machine Shop. It also developed my experience in observing and working with mechanical artifacts. For example, I designed my first star wheel by referring to diagrams in nineteenth century manuals<sup>15</sup>. These texts lacked details about the wheel hub and other dimensions which were critical to achieving a freely spinning wheel that at the same time conducts electricity from its support to its spokes. When subsequently I had the opportunity to examine historical Barlow wheels in museum collections, I traced, sketched and measured the features that were so tricky to work out in metal<sup>16</sup>. My next attempt, which centered on building a wheel with less friction and wobble in its spin, benefited from these observations as well as from my experience in constructing the first wheel and using

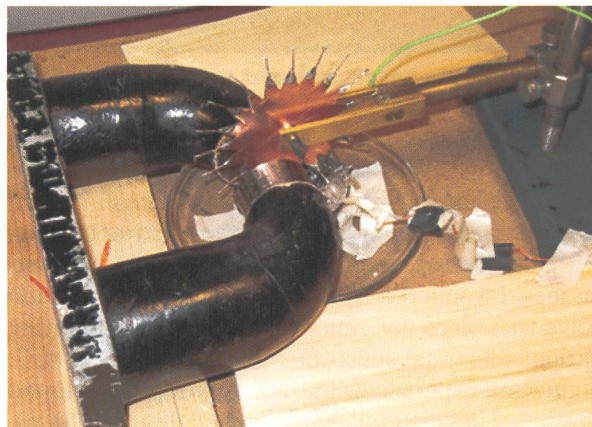

Fig. 9. Arrangement of magnet, my star wheel, galinstan puddle, and connections to power supply (not shown) resulting in motion.

<sup>14</sup> The galinstan alloy is 68.5% gallium, 21.5% indium and 10% tin, having a melting point of  $-19^{\circ}\text{C}$ , boiling point of  $1300^{\circ}\text{C}$ , low vapor pressure, is inflammable with no risk of explosion. The material, first available around 1993, is produced primarily for use in clinical thermometers, by the German company Geratherm [http://www.geratherm.com/en/technologie\\_galinstan](http://www.geratherm.com/en/technologie_galinstan) Due to its resemblance to mercury, galinstan should not be transported by airline passengers. Airline security seized galinstan from my luggage enroute to presenting the Barlow wheel demonstration at a museum.

<sup>15</sup> See Farrar 1839, plate V Figure 141 and Pike 1856, Figures 439, 440 and illustrations of Barlow's wheels made by Daniel Davis Jr. at <http://www2.kenyon.edu/depts/physics/EarlyApparatus/>

<sup>16</sup> I examined the unsigned Barlow wheel number 96.5.3 at the Bakken Museum of Electricity and Life in Minneapolis MN, and a Barlow wheel signed Watkins and Hill, London (see Watkins 1828) at the Smithsonian National Museum of American History, Washington DC, number 315-493.

<sup>17</sup> Ellen Kuffeld, instrument curator at the Bakken Museum, made a star wheel at smaller scale, which I used in experiments before making my second one.

another one<sup>17</sup>. Yet again, it was on trying things out with machined parts that tolerances in spacing showed. For example, it seemed straightforward to sharpen two screws' ends into points and position these points opposite each other with the star wheel's center balanced in between, as done in one historic artifact (Fig. 8). However, it was beyond my rudimentary mechanical skill to work out this alignment; after unsuccessfully trying, I went back to building a hub and axle.

More unexpected subtleties appeared on setting up the wheel to dip into galinstan while conducting current through it. In the initial test of my first wheel, the



current did not break as I turned the star by hand because the star's eighteen points were so close together that one or two points were always immersed in galinstan. I then soldered copper wire extenders to each star point, effectively increasing the star's diameter so that circuital current was alternately on and off as each wire grazed into, and out of, the galinstan. Only then, did I understand the 6 or 9 widely-spaced points of some historical Barlow stars, and begin to suspect that historical wheels having 14 or more points were used for conducting current continuously, without functioning as breakers.

Getting the wheel spinning as a motor under the electromagnetic interaction between its current and a surrounding magnetic field, posed another challenge. The historical texts and artifacts gave little clue in this regard (a magnet was lacking in both historical instruments that I examined). Placing the wheel between the poles of two permanent magnets taped in place, I connected it to batteries. Nothing budged. From Nick Nicola at University of Melbourne, Australia, a present-day demonstrator of Barlow's wheel using liquid mercury, I learned that the motion was very sensitive to the magnet's placement. The greatest force would be applied when the magnetic field gap is crosswise to the dipping spoke – a configuration not clearly portrayed in historical diagrams. For several lab sessions, I continually varied the apparatus: increasing the current with a power supply, repositioning magnets, trying magnets of different strengths.

First indications of motion were a tension in the galinstan surface; on increasing the current, a spoke seemed to stir; at higher current (4.2A at 3V) with a start-off push, the wheel kept going<sup>18</sup>. On readjusting the magnets, all signs of motion were lost. With a large permanent horseshoe magnet (1.5 Kgauss in its gap) and 4.5A applied current, the wheel started spinning on its own (Fig.9)<sup>19</sup>. Amazement shows in my lab book entry: "the wheel Moves! Marvelous – at a slow pace but it moves" (May 6, 2003). Clanging in its support, my makeshift Barlow wheel turned, to the surprise of all others working in the lab. MIT students and instructors alike wondered how this could be, whereas in Page's day such electromagnetic motions were familiar, even state of the art.

<sup>18</sup> My spiral heats perceptibly when conducting currents of the several amperes needed for running the Barlow wheel, and may be damaged by this practice.

<sup>19</sup> With Roger Sherman's assistance, I once activated my Barlow wheel using a pair of small neodymium magnets in place of the large horseshoe, but have not been successful with neodymium magnets since. It remains a challenge to find the relative positions among magnet and wheel which give rise to motion.

Improvisation with materials and stretching in our experience enable things from today's lab to approximate what Page made and did. Yet the working realms differ in so many ways: low currents and voltages from regulated sources are unlike heat-generating flows from acid-immersed metal plates, and a jagged oscilloscope trace lacks the tremor of a human shock. Such contrasts can be productive to interpreting historic experiments, as well as the analogies in what is done. There is much to learn and infer in the spaces intervening where present-day experimenting meets historical accounts through imagining and improvising.

*Fig. 10. Purple sparks show in time exposure plus flash of my star wheel (pulled by string on left) through galinstan. Photo Jeff Tinsley.*

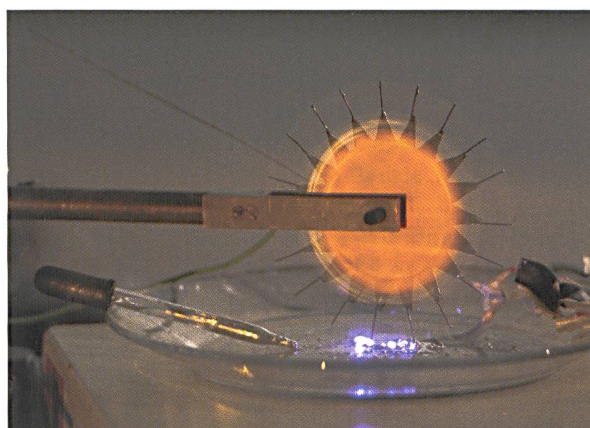

### Observing sparks and shocks with an electrified spiral conductor

While Page saw sparks and felt shocks, he reported about only one effect at a time. Sparks and shocks are detected at different parts of the circuit that Page constructed. Sparks appear wherever the direct path of battery current is interrupted, whether this happens at a wire yanked out of mercury, a rasp scraped by a metal conductor, or at the star wheel's tips. Shocks can be taken across any part of the spiral and its circuit. Sparks are in series with the active circuit, shocks are in parallel. Observing entails an environmental factor as well. Watching sparks means working in the dark; taking shocks involves assistance and other logistics that are helped by having some light. It was similar for me. To see sparks, I needed to be in the darkroom. To observe voltages required room light to see where to insert the probe, an electric outlet, and lab space for the oscilloscope.

Watching sparks is visually beautiful, yet its transitory, qualitative nature appeared to me not effective for evaluating circuit arrangements. The (digital) oscillo-



scope's voltage traces – my working analogue for shock – occurred in a measured space of voltage against time where signal values and patterns could be compared across different events, circuit arrangements, and by other criteria. The trace data always offered more to ask about, try, and redo, continually stimulating new work. As with Page, who went further in experimenting by taking shocks than by seeing sparks, observing with the oscilloscope dominated my lab activities and analyses. Below, after illustrating my star wheel's sparking, there follow some examples from these extensive oscilloscope studies.

Sparking and crackling arise at the shifting point where the star wheel's not-quite coplanar spokes exit the galinstan glob to momentarily break the circuit connection with the spiral and power supply. Omitting the spiral from the circuit diminishes the effect; the high voltages induced in the spiral's turns are germane to the visual spark. When observing sparks I do not spin the wheel under Barlow's effect, due to the magnet's visual obstruction and its finickiness regarding position. Instead, like Page, I pull the wheel into rotation "with a string" (Page 1837a, p. 141).

Color is the most striking manifestation of the spark that I have observed<sup>20</sup>. Sparks glow purple where galinstan combusts under inductive action countering the cessation of current in the spiral (Fig. 10). The emerald-hue sparks described by Page as arising from silver leaf added to the star wheel's points were so intriguing that I looked into this, both in texts and experimentally. Perhaps Page saw the spectral colors of metal foils combusted by electrostatic discharge during his undergraduate chemistry course. This demonstration is described in the substantially revised succeeding edition of his professor's textbook (Webster 1839, para. 306)<sup>21</sup>. A subsequent application took the form of ratchet wheels made interchangeably of different metals that interrupted current in some early hand-cranked electromagnetic

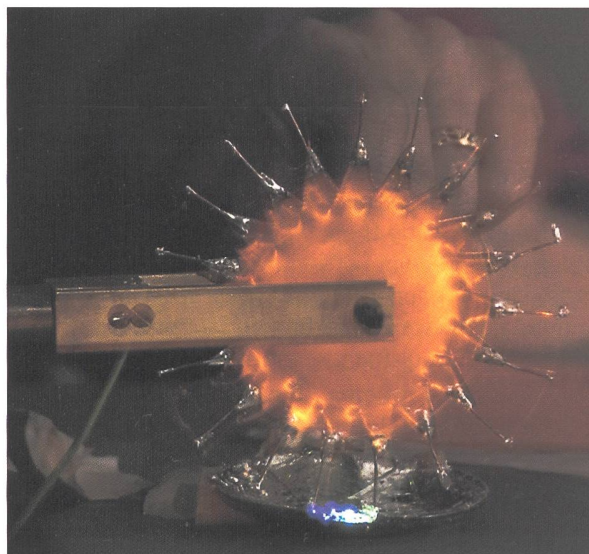

Fig. 11. Green spark where silver leaf attached to tips (see top right) combusts. Photo Jeff Tinsley.

machines<sup>22</sup>. To try Page's effect, I ripped bits of silver, gold and copper leaf with tweezers, and adhered these, again by tweezers, to the star's tips. On spinning the wheel – by pulling a string wound around its axle – only occasionally did brilliant green (for the silver leaf) or pale blue (for the copper and gold) flash momentarily in the dark. The most stunning color flares were rare, hard to capture photographically, and, unlike the implication of Page's text, distinctive leaf color was not concurrent with every sparking event (Fig. 11).

Such lack of consistency pervaded my observing of the spiral circuit with oscilloscope probes. I persisted in experimental repetitions and variations, trying to develop a sense of what was happening. This experience brought me to appreciate how Page might also have repeatedly taken shocks, trying with each one to fix more clearly in his mind how the transient sensation felt.

Page felt shocks wherever his hands went across the spiral, likewise I observed voltage pulses in every part of it. When battery leads, and the probe were together applied across first an inner segment of the spiral, and then across more, the pulses were generally greater (Fig. 12). This correlated with Page's finding that shocks (not sparks) increase with a longer common path for both the battery and the shock. And when the battery current was constrained to the spiral's inner part, while the probe looked elsewhere, I detected lesser pulses in windings that were entirely beyond the battery current's path. These signals have their counterpart in those Page considered "contrary to expectation", and which he amplified by piecing needles into his fingertips (Page 1837a, p. 139).

<sup>20</sup> I have not reproduced the stroboscopic lighting of the whole wheel described by Page; this may depend on having higher currents.

<sup>21</sup> The textbook's next edition gave the colors of metal leaf ignited by electrostatic discharge: gold leaf – blue-white; silver leaf – emerald green; copper – blue-white; lead – purple; zinc – white (Webster 1839). Webster cited an analogous demonstration, but without metal foils, in Singer 1814 (p. 92). Webster's earlier editions (1826, 1828) do not discuss this effect.

<sup>22</sup> George Bachhoffner (1838) described both the sparking combustion of metal leaves, and the varied metal spur interrupters. The London Science Museum holds an instrument of his design, signed E. Palmer, Newgate St. London, having interchangeable wheels stamped with letters L (lead), Z (zinc), T (tin?) and B (number 1900-124).

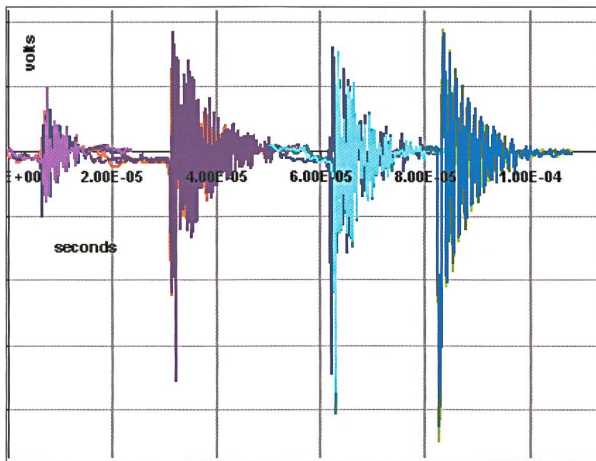
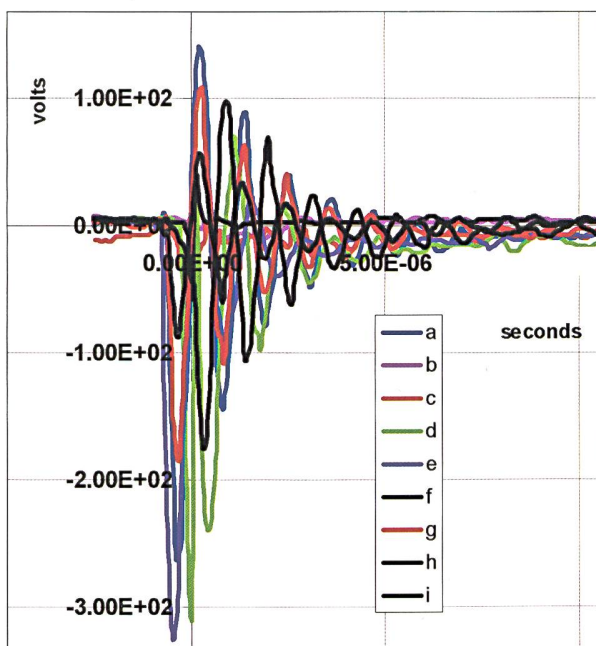

Fig. 12. Stagger-plot showing general increase of voltages induced when both battery current and probe are placed across successively longer spans of the spiral, from far right (pink) inner segment to far left (blue-green) entire spiral. Vertical: 100V/div. Horizontal: 20µs/div.

Although some of Page’s claims could be re-demonstrated somewhat consistently with my apparatus, one eluded my determined efforts. On putting battery current only through the inner half while taking the shock (at current cessation) across more and then more of the spiral, Page sensed elevations shock severity. But when I applied leads from the battery and probe across comparable portions of my spiral, I

Fig. 13. Overlay of 9 voltage traces (a-i), induced successively in the spiral with star wheel interrupter; with no changes in circuit between events. Vertical: 100V/div. Horizontal: 5µs/div.



could not discern any trend in the signals picked up on the oscilloscope. I could not tell whether their peak values were increasing, or not.

Baffled by the ambiguity of voltage peaks that fluctuated widely even when nothing in the circuit configuration had changed (Fig. 13), I replaced mechanical switching with periodic electronic pulses. These electronic pulses, applied at low voltage either as square spikes or sinusoidal waves variable in frequency, provided consistency in how the spiral was stimulated (Fig. 14).

As I then tried to understand the signals arising within the variously stimulated spiral, I found the spiral to be complex, responding more to some frequencies, than

Fig. 14. A 20kHz sine wave is applied to the spiral’s inner section (dark blue). As the probe is placed across more of the spiral, the signal voltage rises (lavender to red). Vertical: 2V/div. Horizontal: .1ms/div.

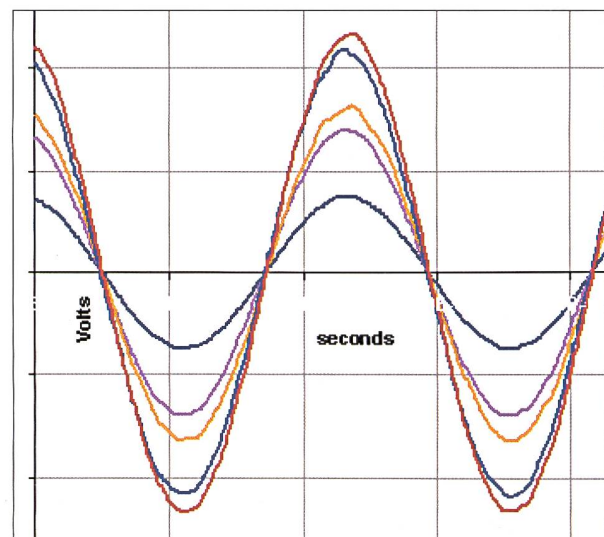

to others. This behavior fascinated me. I researched it extensively across frequencies ranging from Hz to MHz, sometimes identifying resonances on the timescale of the oscillations that occur when the spiral is stimulated by the star wheel interrupter (Fig. 15). Through gradually gaining experience with the oscilloscope, I came upon data collection methods giving an alternative view of the electrical signals induced within the spiral. With these features, the high variability of the spiral’s response to star wheel switching could be framed in ways that show different aspects of what is happening. Previously I had only observed (and saved) single pulses one at a time; overlay plots of several pulses show similarities in the timing structure (reflecting the frequency behavior discussed above) along with great variation in peak voltage (Fig.



13). I began using oscilloscope software to take in pulses consecutively as I turned the star wheel while keeping the rest of the circuit fixed. It performed certain operations on this incoming data and saved the outcome. My perception changed from the original restriction to one event at a time, to a form representing 256 consecutive pulse events. Each set of 256 events could be compared with another set whose data was taken while placing the probe across another part of the spiral. Now, patterns sometimes emerged in voltage that bore some relation to Page's sensation-based reports.

Fig. 15. Log-log overlay of spiral response at different applied frequencies. Notice the dip around 1 MHz. Vertical: Impedance ( $\Omega$ ), Horizontal: Frequency in Hz; Two decades/division.

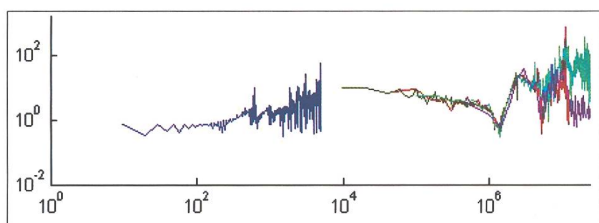

Single-event voltage traces take on positive and negative values, peaking early and declining with time. For each event, these values may be higher, lower, and/or temporally displaced from those of preceding events. As one method of depicting the cumulative effect of these variable events, I set the oscilloscope to track extremal voltage values by registering the maximal and minimal values reached at each time (bin) during a run of (256) consecutive events. With this data, I constructed an outer envelope of the maximal voltages exhibited by traces during each run. Next I superimposed on a single plot, the outer (maximal) envelopes obtained in different runs corresponding to different configurations of the circuit. In the case where for each run, I placed *both* the battery current *and* the probe across more of the spiral, the maximal voltages showed a trend of increasing across the spiral (Figure 16 left). But, when I stimulated only one inner segment of the spiral, while for each next run I placed the probe across longer spans of it, the maximal voltages showed no clear trend of increase (Figure 16, right). Ambiguity remains in my observations of spiral intervals wider than the current-bearing segment – when mechanical switching is used.

For Page and for me, observing the spiral involved changes: in the environment from light to dark; in sensing from vision to feeling to electronic detection; in the switching apparatus; in the frequency of stim-

ulation or duration of collecting data. Any change was like having another window to look through. Our windows are not the same – Page's readiness to be shocked; my graphical voltage displays – what is most immediate in one view may be hard to infer from another. Each viewing showed more about inductive phenomena – more to question, more to investigate. The complexity of these underlying phenomena, that can sustain multiple kinds of viewing across historical time, gives resilience to the process of replicating science experiments. And, whether it is Page replicating Henry, or me replicating Page, that there is always more to notice and do, stems from authenticity in the experimental experience.

Fig. 16. Overlay plots of maximal and minimal envelopes produced in runs consisting of 256 induced events. Left: Red – For this run, battery current, a resistor (as a body model) and probe are placed across inner spiral segment; Blue – battery current, resistor and probe go midway across spiral; Black – battery current, resistor and probe are placed across whole spiral (peak is 80 V, time interval is 10  $\mu$ s). Right: Red – battery current, resistor and probe are across inner spiral; Blue – battery current remains across inner spiral while probe and resistor go midway across it; Black – battery current remains across inner spiral while probe and resistor go across whole spiral (peak is 140V, time interval is 20  $\mu$ s).

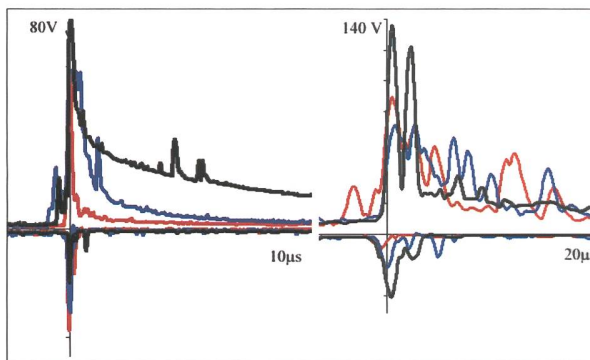

## Conclusion

Redoing experiments is improvisational. We make do and adapt – as Page slitted copper sheet or I rewound copper foil tape. We observe – as Page took shocks or I probed for voltage signals. We come up with more to try than the original experimenter imagined – as Page took shocks outside the battery current's direct path, or I searched for resonant frequencies. The windows that sparks, shocks and voltage traces give into experience are only a beginning. On moving through these windows while replicating experiments, we become involved in experiences of our own, where prior and present experiences cross-connect with each other and the natural phenomena. Happening sometimes

unexpectedly, sometimes unnoticed, this is improvisational as well. What keeps it ongoing is flexibility in seeing possibilities – new and old — arising in experiences with materials.

Physicist Niels Bohr described the work of science as “to extend the range of our experience and to reduce it to order” (Bohr 1934, p. 1). In redoing experiments from historical science, we are extending experience. New observations come up, both about the spiral with its induced voltages, and about the improvising, looking and reflecting that experimenters do. Redoing physical effects from long ago, like the Barlow wheel, extends *our* experience and challenges *our* understanding of what we think we know. The order we construct through re-enacting these historical experiences encompasses history, science, and ourselves. While what we seek is surely not the same understanding held by Page and his contemporaries, our respect for that work deepens, and questions arise that take the work on into unforeseen, yet integral, legacies. For the future, researching historical science by reengaging with its experiments offers prospects for involving students and wider communities with science experience that is both personal and shared across expanses of time. Letting our experiences with science emerge into view, through many windows, is a way that history of science could empower the public to see how it is that ordinary people in the past – and still today – explore and come to understand the things around them.

## Acknowledgements

The MIT Edgerton Center gave this experimental project a home across the several years and multiple phases of its development. I thank James Bales, Tony Caloggero, Ed Moriarty, Fred Cote, Toby Bashaw and students for many productive conversations. Professor Markus Zahn discussed my data, analyses and experiment; technicians Wayne Ryan and Lourenco Pires taught measurement techniques. Thomas Cavicchi responded to my queries on all aspects of the experiment. Chen-Pang Yang examined plots, data, and drafts. Grant Suter, at Agilent, advised on using the oscilloscope. I learned through discussions and demonstrations with: Roger Sherman, Jeff Tinsley, Deborah Jean Warner (Smithsonian National Museum of American History); Ellen Kuffeld and David Pantalony (Bakken Museum of Electricity and Life); Peter Heering, Ryan Tweney, Christian Sichau, Larry Principe (History of Science session); Wolfgang Rueckner and Joe Peidel (Harvard Science Center); Adrian Whicher (London Science Museum); Alberto Martinez and Yunli Shi (Dibner Institute), and Rebekah Maggor. My understanding benefited from opportunities to present this experiment with its apparatus at the Smithsonian NMAH, Bakken Museum, History of Science Society, and to a class at Dartmouth College taught by Richard Kremer and Frank Manasek. This project was supported by the Dibner Institute for the History of Science and Technology. Internet access was supported by Tufts U. Computer Science. Alva Couch sustains my daily explorations. Robert Post’s insightful admiration for Page encouraged my continuing experimental studies. I give this work to the memory of Philip Morrison, ever-inspiring for extending and deepening our experiences with nature.

## References

- **BACHHOFFNER G.** 1838. Popular Treatise on Voltaic Electricity and Electro-Magnetism. Simpkin, Marshall, Palmer, London.
- **BOHR NHD.** 1934. Atomic theory and the description of nature. Cambridge U Press.
- **BARLOW P.** 1822. A curious electro-magnetic Experiment. Philosophical Magazine, 59: 241-242.
- **CAVICCHI E.** 2003. Experiences with the magnetism of conducting loops: Historical instruments, experimental replications, and productive confusions. American Journal of Physics, 71(2): 156-167.
- **DAVIS D.** 1838. Catalogue of Apparatus, Boston MA.
- **DAVIS D.** 1842. Manual of Magnetism, Boston MA.
- **DEWEY J.** 1934. Art as Experience. Milton, Balch & Co., NY.
- **FARADAY M.** 1831. Experimental Researches in Electricity: First Series. Reprinted in Experimental Researches in Electricity, 1, Green Lion, Sante Fe, 2000/1839, 1-41.
- **FARADAY M.** 1834. On the Magneto-electric Spark and Shock, and on a peculiar Condition of Electric and Magneto-electric Induction. Philosophical Magazine, 5: 349-354.
- **FARRAR J.** 1839. Elements of electricity, magnetism, and electro-dynamics. Hilliard, Gray and Company, Boston.
- **FLEMING JA.** 1892. The alternate current transformer in theory and practice, vol. 2. “The Electrician” printing: London.



- **GREENE JC.** 1984. *American Science in the Age of Jefferson*. Iowa State University Press, Ames IA.
- **GWEI-DJEN L, NEEDHAM J.** 1980/2002. *Celestial Lancets: A History and Rationale of Acupuncture and Moxa*. RoutledgeCurzon, London.
- **HARE R.** 1818. A New Theory of Galvanism...by means of the Calorimotor, a new Galvanic Instrument. *American Journal of Science*, 1: 412-423.
- **HEERING P.** 2002. Analyzing Experiments with Two Non-canonical Devices: Jean Paul Marat's Helioscope and Perméomètre. *Bulletin of the Scientific Instrument Society*, 74, 8-15.
- **HENRY J.** 1835. Facts in reference to the Spark, &c. from a long conductor uniting the poles of a Galvanic Battery. *Journal of the Franklin Institute*: 169-170, and *American Journal of Science*, 28: 327-329, Appendix to the above, 329-331.
- **HENRY J.** 1837. Description of a Galvanic Battery for producing Electricity of different Intensities. *American Philosophical Society Transactions* (1837): 213-223; reprinted in *The Scientific Writings of Joseph Henry*, 1, (Washington DC, 1886).
- **KURZ EM, HERTWIG R.** 2001. To Know an Experimenter, *In*: Hammond KR, Stewart TR (eds.), *The Essential Brunswick: Beginnings, Explications, Applications*. Oxford U. Press, Oxford, p. 180-186.
- **LANE JH.** 1869. Charles Grafton Page. *American Journal of Science*, 48, 1-17.
- **OERSTED JC.** 1820. Experiments on the Effect of a Current of Electricity on the Magnetic Needles, *Annals of Philosophy*, 16: 273-276.
- **PAGE CG.** 1833. Notice of some New Electrical Instruments. *American Journal of Science*, 36: 110-112.
- **PAGE CG.** 1836. Medical Application of Galvanism. *Boston Medical and Surgical Journal*, June 22, 1836, 333.
- **PAGE CG.** 1837a. Method of increasing shocks, and experiments, with Prof. Henry's apparatus for obtaining sparks and shocks from the Calorimotor. *American Journal of Science*, 31: 137-141.
- **PAGE CG.** 1837b. On the use of the Dynamic Multiplier, with a new accompanying apparatus. *American Journal of Science*, 32: 354-360.
- **(PAGE CG)** 1867. *The American Claim to the Induction Coil and its Electrostatic Developments*. Intelligencer Printing House, Washington DC.
- **PETER R.** 1836. On the application of galvanic electricity to medicine. *Southern Medical and Surgical Journal*, 1.
- **PIAGET J, INHELDER B.** 1948. *The Child's Conception of Space*. Norton, NY.
- **PIKE B.** 1856(1984) *Illustrated descriptive catalogue of optical, mathematical and philosophical instruments*. Facsim. ed. D. J. Warner, ed. *Antiquarian Scientist*; San Francisco, CA.
- **POST RC.** 1976. *Physics, Patents & Politics: A Biography of Charles Grafton Page*. Science History Publications, NY.
- **REILEY JP.** 1998. *Applied Bioelectricity: From Electrical Stimulation to Electropathology*. Springer, NY.
- **SETTLE T.** 1996. *Galileo's Experimental Research*. Max Planck Institute for the History of Science, Berlin.
- **SHERMAN R.** 1988. Charles Page, Daniel Davis, and their electromagnetic apparatus, *Rittenhouse*, 2: 34-47.
- **SICONOLFI S, NUSYNOWITZ M, SUIRE S, MOORE A Jr, LEIG J.** 1996. Determining blood and plasma volumes using bioelectrical response spectroscopy. *Medicine and Science in Sports and Exercise*, 28: 1510-1516.
- **SINGER, GJ.** 1814. *Elements of Electricity and Electrochemistry*. Longman, Hurst, Rees, Orme, Brown and Triphook: London.
- **TWENEY R.** 2006. *Discovering Discovery: How Faraday Found the First Metallic Colloid*, *Perspectives on Science*, in press.
- **WATKINS F.** 1828. *A Popular Sketch of Electro-magnetism or Electrodynamics*. John Taylor, London.
- **WEBSTER JW.** 1826. *A Manual of Chemistry, on the basis of Professor Brande's...* Richardson & Lord, Boston.
- **WEBSTER JW.** 1828. *A Manual of Chemistry, on the basis of Professor Brande's...* (2d ed.) Richardson & Lord, Boston.
- **WEBSTER JW.** 1839. *A Manual of Chemistry, containing the principle facts*, 3d ed. Marsh, Capen, Lyon and Webb, Boston.