

Zeitschrift: Berichte des Geobotanischen Institutes der Eidg. Techn. Hochschule, Stiftung Rübél

Herausgeber: Geobotanisches Institut der Eidg. Techn. Hochschule, Stiftung Rübél

Band: 55 (1989)

Artikel: Studies on competition between closely related species of *Scabiosa columbaria* L.s.l. Part 2. Differentiation of hybrid populations under different temperature, water and nutrient conditions = Konkurrenzuntersuchungen zwischen nah verwandten Arten von *Scabiosa columbaria* L.s.l. : Teil II. Differenzierung von Bastardpopulationen unter verschiedenen Temperatur-, Feuchtigkeits- und ...

Autor: Landolt, Elias / Binz, Hans-Rudolf

Kapitel: 4: Results of part 2

DOI: <https://doi.org/10.5169/seals-377754>

Nutzungsbedingungen

Die ETH-Bibliothek ist die Anbieterin der digitalisierten Zeitschriften. Sie besitzt keine Urheberrechte an den Zeitschriften und ist nicht verantwortlich für deren Inhalte. Die Rechte liegen in der Regel bei den Herausgebern beziehungsweise den externen Rechteinhabern. [Siehe Rechtliche Hinweise.](#)

Conditions d'utilisation

L'ETH Library est le fournisseur des revues numérisées. Elle ne détient aucun droit d'auteur sur les revues et n'est pas responsable de leur contenu. En règle générale, les droits sont détenus par les éditeurs ou les détenteurs de droits externes. [Voir Informations légales.](#)

Terms of use

The ETH Library is the provider of the digitised journals. It does not own any copyrights to the journals and is not responsible for their content. The rights usually lie with the publishers or the external rights holders. [See Legal notice.](#)

Download PDF: 08.02.2025

ETH-Bibliothek Zürich, E-Periodica, <https://www.e-periodica.ch>

- *S. gramuntia* grown in mixed culture with a high water table level and low fertilizer treatment produced about twice as many flower-heads as *S. columbaria*; in pure culture it was only about 1 1/2 times as many.
- Differences occurring between mixed cultures and pure cultures in the greenhouse were not very pronounced and in general statistically insignificant. However, under these same conditions a correlation seems to exist between the growth in pure culture and the vegetative competition; accordingly, the following sequence of the competition potential can be established: *S. gramuntia* \geq *S. columbaria* \geq *S. lucida*.
- Under cool conditions *S. lucida* has an advantage over the other two species in so far as its fruit comes to maturity, whereas a large proportion of that of the other species do not ripen.

4. RESULTS OF PART II

The results of part II are summarized in the Figs. 32 to 40.

4.1. Variability of the characteristics under identical and differing conditions

The variability is shown for each characteristic under warm and cool conditions and from the ground water table experiment under the combination of low water table level and high fertilization. These examples are also representative for other conditions.

4.1.1. Hair density (Figs. 5 to 7)

Variability of hair density is in all three species not very high. Within the first three years hair density remains quite stable. Also under differing conditions there is not much variation within each species. Only *S. columbaria* and *S. lucida* show a slightly higher density under warm conditions compared with cool ones. But the difference is insignificant (Tables 7 and 8).

After 1970 the first generation of crossings were fully grown. Therefore the measurements included this mixed generation as well as the pure species. The total variability is very high, as expected. It reduces after 1973 to the smallest levels in 1985 (for the greenhouse conditions) and in 1979 (for the ground water plots). The higher variability in 1983 for these populations is probably due to the matu-

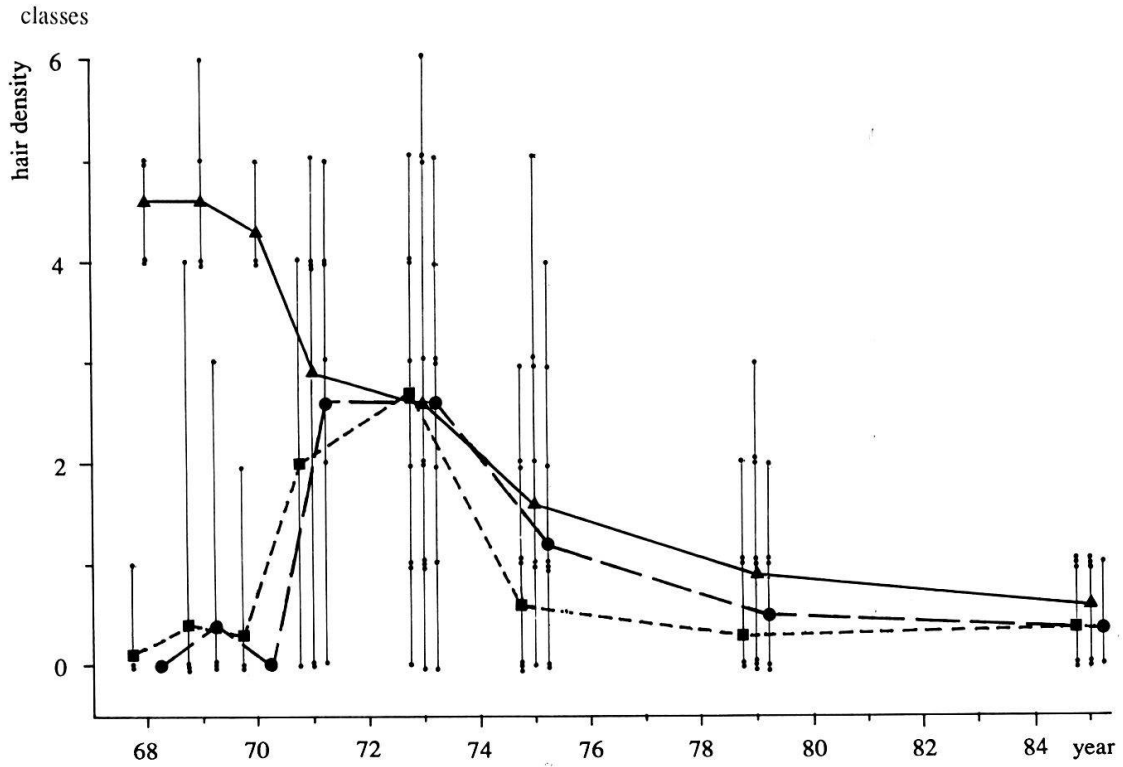

Fig. 6. Cool conditions - *kühle Bedingungen*

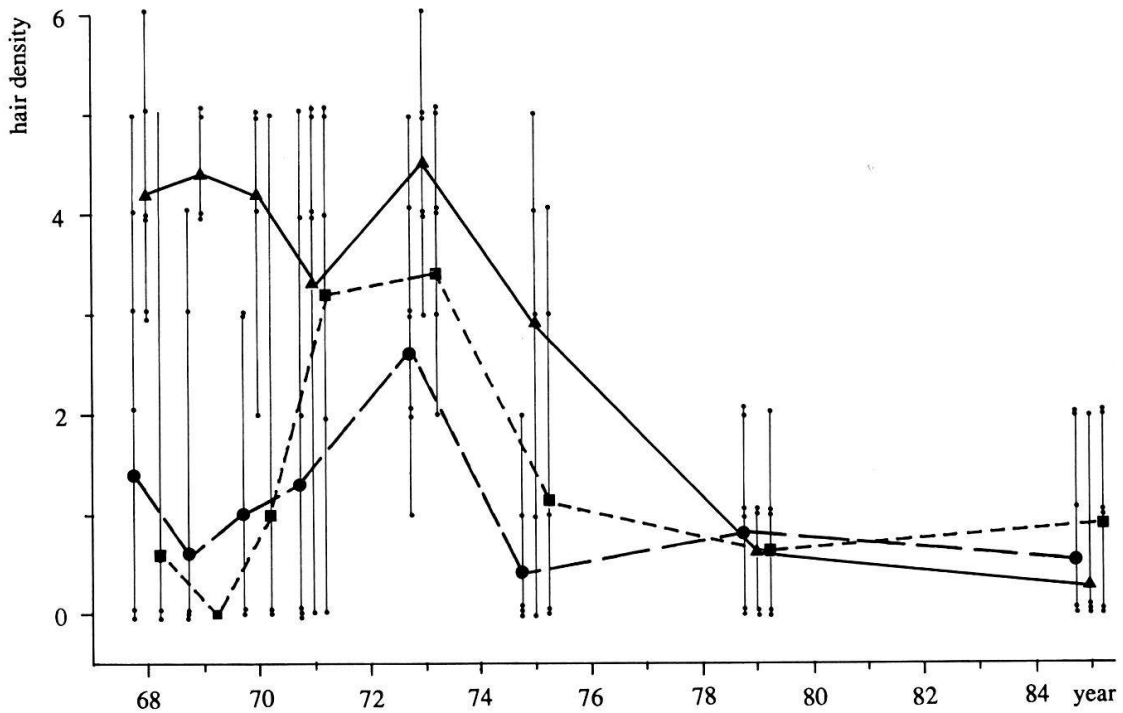

Fig. 6. Warm conditions - *warme Bedingungen*

Figs. 5-7. Hair density on rosette leaves of *Scabiosa* populations
Haardichte der Rosettenblätter von Scabiosa-Populationen

■ *S. lucida* ● *S. columbaria* ▲ *S. gramuntia* } total variation with individual values
 ★ mixed population

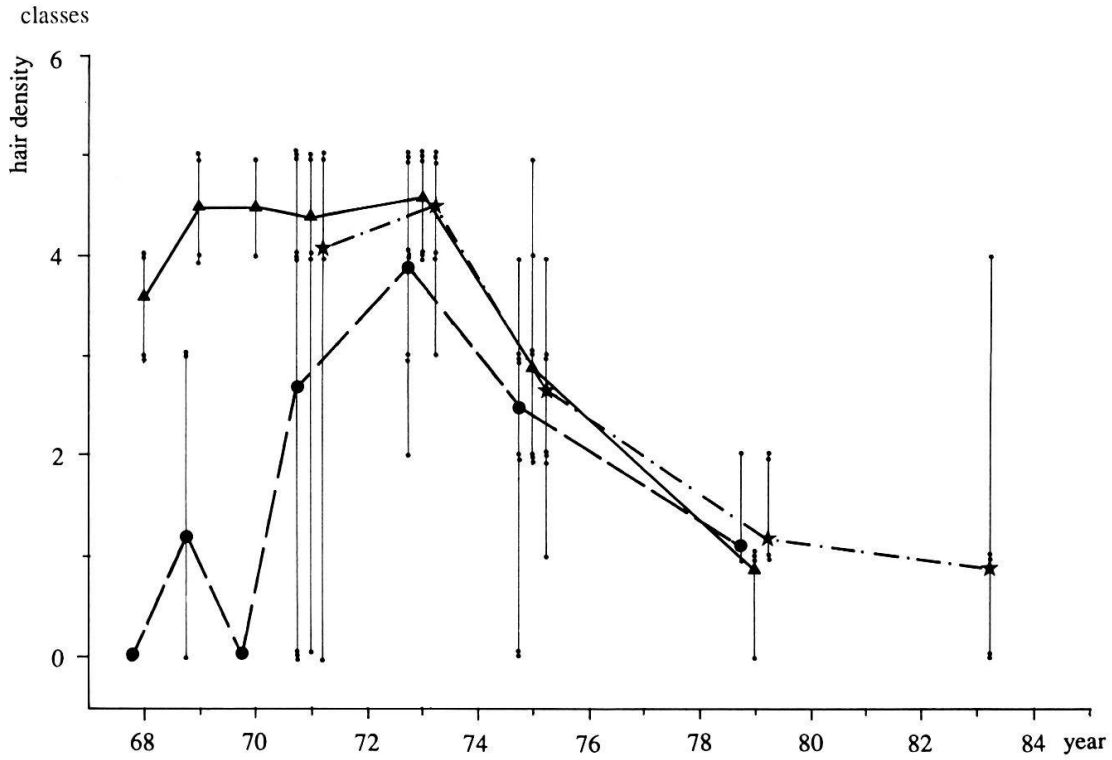

Fig. 7. Ground water plots with a water table level at 145 cm below the surface and well fertilized.
Grundwasserbecken mit einem Wasserstand von 145 cm unter Flur und stark gedüngt.

ration of young plants of a new generation which did not yet undergo full selection. In 9 out of 14 different conditions the change of the mean values within the last 3 (respectively 5) years is still higher than 10%.

Table 7. Significant differences between the measured characteristics of *S. lucida* 1968 (luc) *S. columbaria* 1968 (col), *S. gramuntia* 1968 (gram) and the final populations in 1985 (M) respectively under warm (30°/20°C) and cool (17°/7°C) conditions in the greenhouse and between the species and the final populations under warm conditions and cool conditions respectively.

Gesicherte Unterschiede in den gemessenen Merkmalen von S. lucida 1968 (luc), S. columbaria 1968 (col), S. gramuntia 1968 (gram) und den Mischpopulationen 1985 (M) unter warmen (30°/20°C) bzw. kühlen Bedingungen (17°/7°C) im Gewächshaus sowie zwischen den Ausgangsarten und den Endpopulationen je unter warmen und kühlen Bedingungen.

Significance level *Signifikanzniveau*: 1 = 95%, 2 = 99%, 3 = 99.9%, - = insignificant

a = hair density - *Haardichte*

b = length of calyx setae - *Kelchborstenlänge*

c = width of calyx setae - *Kelchborstenbreite*

d = stalk length - *Blütenstiellänge*

e = stem length - *Stengellänge*

f = length of the uppermost rosette leaf - *Länge des obersten Rosettenblattes*

g = length of terminal lobe of cauline leaf - *Länge des Endabschnittes des obersten Stengelblattes*

h = length / width of terminal lobe - *Länge / Breite des Endabschnittes des obersten Stengelblattes*

i = length of terminal lobe / rosette leaf - *Länge des Endabschnittes / Länge des letzten Rosettenblattes*

Conditions and populations in comparison	Characteristics								
	a	b	c	d	e	f	g	h	i
Temperature									
<i>S. lucida</i> 1968 warm/cool	-	1	-	-	-	-	-	-	-
<i>S. columbaria</i> 1968 w/c	-	-	1	-	-	-	-	1	-
<i>S. gramuntia</i> 1968 w/c	-	-	2	3	-	-	3	3	1
Final population 1985 w/c	-	3	3	2	3	3	-	-	3
warm									
luc/col	-	2	3	-	-	-	-	1	-
luc/gram	3	3	3	-	3	2	-	3	3
col/gram	3	2	3	-	3	2	-	-	3
luc/M	-	3	3	2	3	1	3	2	-
col/M	-	2	3	-	3	-	3	-	-
gram/M	3	-	-	1	-	-	3	-	3
cool									
luc/col	-	2	-	-	-	-	1	1	-
luc/gram	3	3	2	3	3	3	3	3	-
col/gram	3	-	1	-	3	3	-	1	2
luc/M	-	3	-	3	2	-	3	1	-
col/M	-	2	-	-	1	-	3	3	3
gram/M	3	3	3	1	3	3	-	3	3

Table 8. Significant differences between the measured characteristics of *S. columbaria* 1968 (col), *S. gramuntia* 1968 (gram) and the final populations in 1985 (M) respectively under different conditions and between the species and the final populations under all conditions and strong fertilization (D₃₀) respectively.

Gesicherte Unterschiede in den gemessenen Merkmalen von S. columbaria 1968 (col), S. gramuntia 1968 (gram) und den Mischpopulationen 1985 (M) unter je verschiedenen Bedingungen sowie zwischen den Ausgangsarten und den Endpopulationen unter allen Bedingungen bzw. unter starker Düngung (D₃₀).

Significance level - Signifikanzniveau: 1 = 95%, 2 = 99%, 3 = 99.9%, - = insignificant

B_x, D_x, G_x see Table 5.; a to i see table 7. B_x, D_x, G_x vgl. Tab. 5.; a - i vgl. Tab. 7.

Conditions and populations in comparison	Characteristics								
	a	b	c	d	e	f	g	h	i
Fertilization (D)									
<i>S. gramuntia</i> 1968 D ₃₀ /D ₃	-	1	-	-	-	3	-	-	2
<i>S. columbaria</i> 1968 D ₃₀ /D ₃	-	-	-	-	-	3	-	-	-
Final population 1983 D ₃₀ /D ₃	3	-	1	-	3	3	1	-	2
<i>S. gramuntia</i> 1968 D ₃₀ /D ₀	-	2	-	2	-	3	-	-	1
<i>S. columbaria</i> 1968 D ₃₀ /D ₀	-	-	-	1	-	3	-	-	-
Final population 1983 D ₃₀ /D ₀	3	-	-	3	3	3	1	-	3
<i>S. gramuntia</i> 1968 D ₃ /D ₀	-	-	-	1	-	-	-	-	-
<i>S. columbaria</i> 1968 D ₃ /D ₀	-	-	-	-	-	-	-	-	-
Final population 1983 D ₃ /D ₀	-	1	-	3	1	3	-	-	-
Water table (G)									
<i>S. gramuntia</i> 1968 G ₄₅ /G ₁₄₅	-	-	3	-	-	-	-	-	-
<i>S. columbaria</i> 1968 G ₄₅ /G ₁₄₅	-	-	-	-	-	-	-	-	-
Final population 1983 G ₄₅ /G ₁₄₅	-	-	-	-	-	-	-	-	-
Watering interval (B)									
<i>S. gramuntia</i> 1968 B _{nat} /B ₇	3	-	1	-	-	1	-	-	-
<i>S. columbaria</i> 1968 B _{nat} /B ₇	1	-	3	-	-	2	-	-	1
Final population 1983 B _{nat} /B ₇	-	-	-	2	3	3	3	-	-
<i>S. gramuntia</i> 1968 B ₇ /B ₂₈	-	-	-	-	1	2	-	1	-
<i>S. columbaria</i> 1968 B ₇ /B ₂₈	-	-	-	-	-	-	-	-	-
Final population 1983 B ₇ /B ₂₈	1	2	-	-	3	-	-	-	-
<i>S. gramuntia</i> 1968 B _{nat} /B ₂₈	-	-	1	3	1	3	-	2	2
<i>S. columbaria</i> 1968 B _{nat} /B ₂₈	-	-	3	-	-	3	-	-	-
Final population 1983 B _{nat} /B ₂₈	3	2	1	3	1	3	3	-	-
All conditions									
col/gram	3	3	3	3	3	3	3	3	3
col/M	3	3	3	3	3	-	-	2	3
gram/M	3	-	1	3	1	1	3	2	-
D₃₀									
col/gram	3	-	3	-	3	1	1	-	3
col/M	3	3	3	-	3	3	1	-	3
gram/M	3	-	-	-	3	2	-	-	-

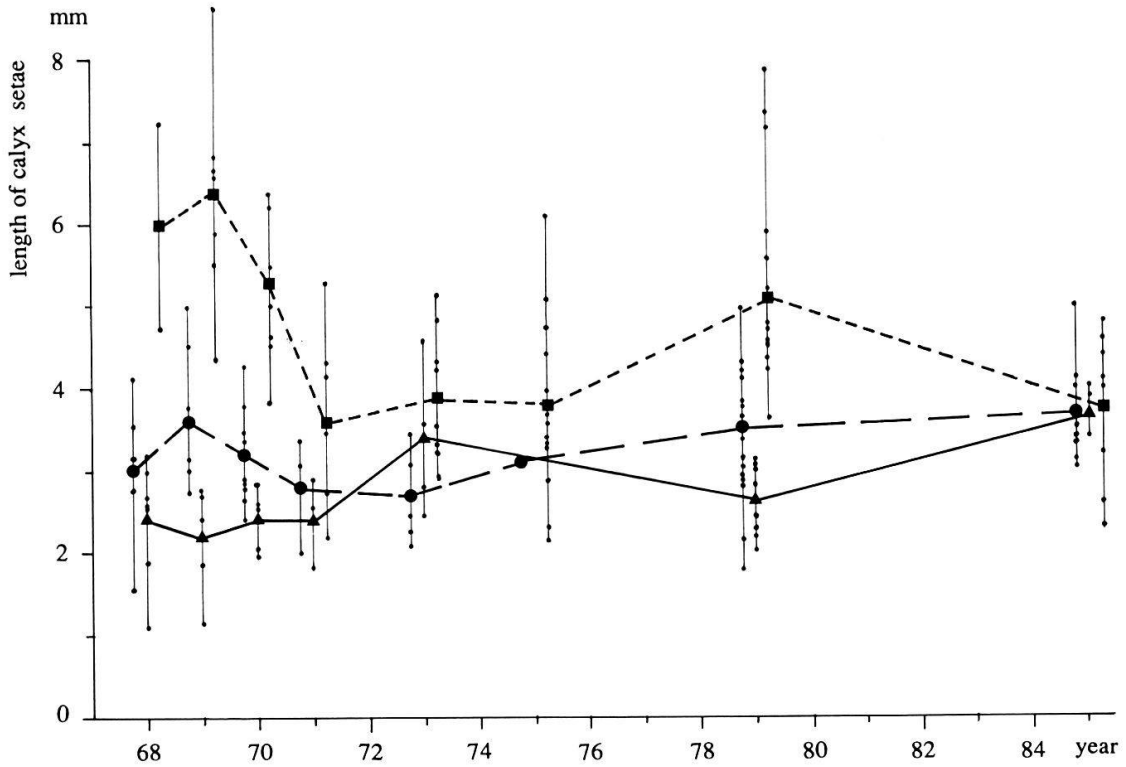

Fig. 8. Cool conditions - *kühle Bedingungen*

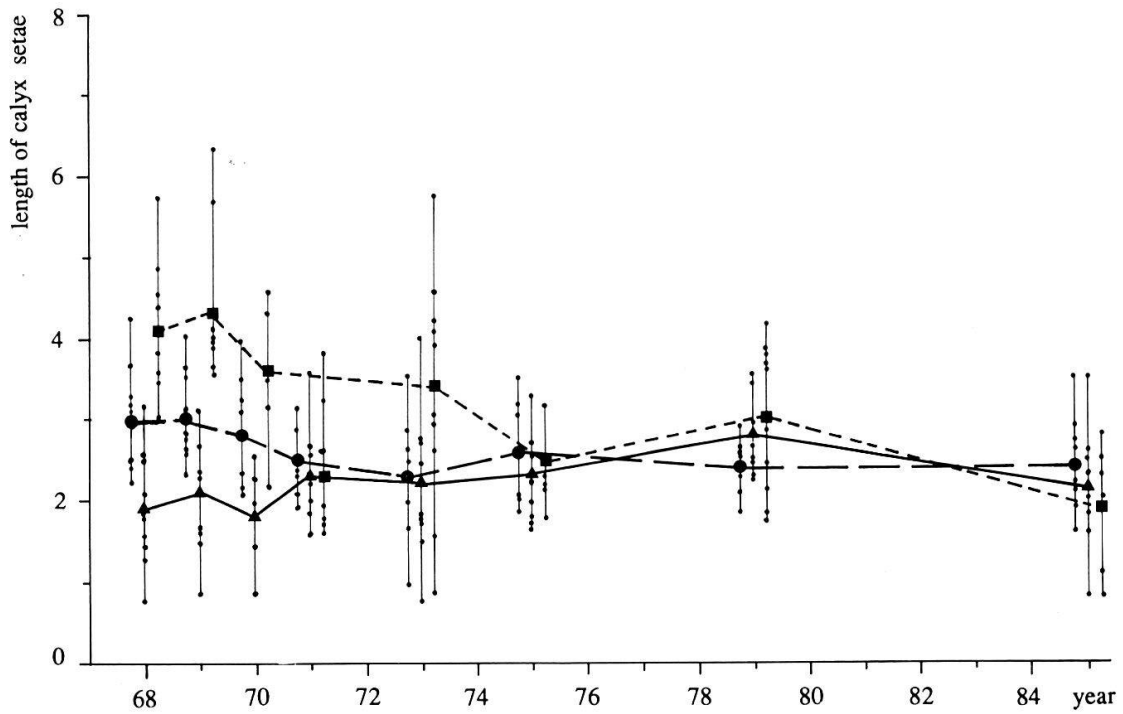

Fig. 9. Warm conditions - *warme Bedingungen*

Figs. 8-10. Length of calyx setae of *Scabiosa* populations
Kelchborstenlänge von Scabiosa-Populationen

■ *S. lucida* ● *S. columbaria* ▲ *S. gramuntia* † total variation with individual values
★ mixed population

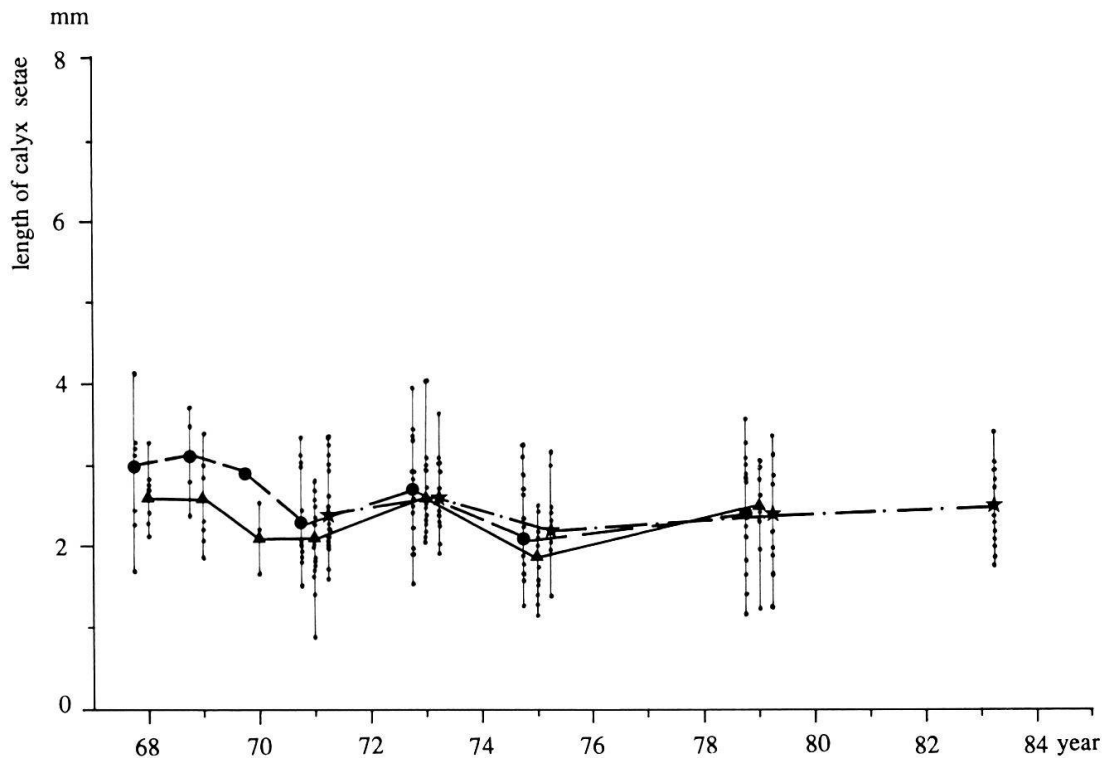

Fig. 10. Ground water plots with a water table level at 145 cm below the surface and well fertilized.

Grundwasserbecken mit einem Wasserstand von 145 cm unter Flur und stark gedüngt.

4.1.2. Length of calyx setae (Figs. 8 to 10)

The variability of the length of calyx setae is medium. The deviations are sometimes more than 20% from the mean. The yearly variability (during the first three years) is about 10% around the mean.

Warm conditions tend to cause shorter setae. However, the difference is only significant for *S. lucida* (Tables 7 and 8). No other variance was observed which could be attributed to the different environmental conditions, except longer setae for *S. gramuntia* under low fertilization.

The variability during the first years after maturation of crossings (1971 and later) is rather high and contains the whole variability of all three species. Toward the end of the experiments (1985 and 1983) variability became much smaller. The difference between the two mean values of the last three years is mostly less than 10%.

4.1.3. Width of calyx setae (Figs. 11 to 13)

The width of calyx setae is more variable than the length. The variability is rather high within one species and between different years (considering the first three years).

In warm conditions the setae are narrower than in cold ones (the difference is significant for *S. columbaria* and *S. gramuntia*, Table 7). The same is true under dry conditions.

The variation of the mixed populations is highest in 1971 and lowest toward the end of the experiment (1985 and 1983). Except for cool conditions the mean values decreased somewhat within the last three years.

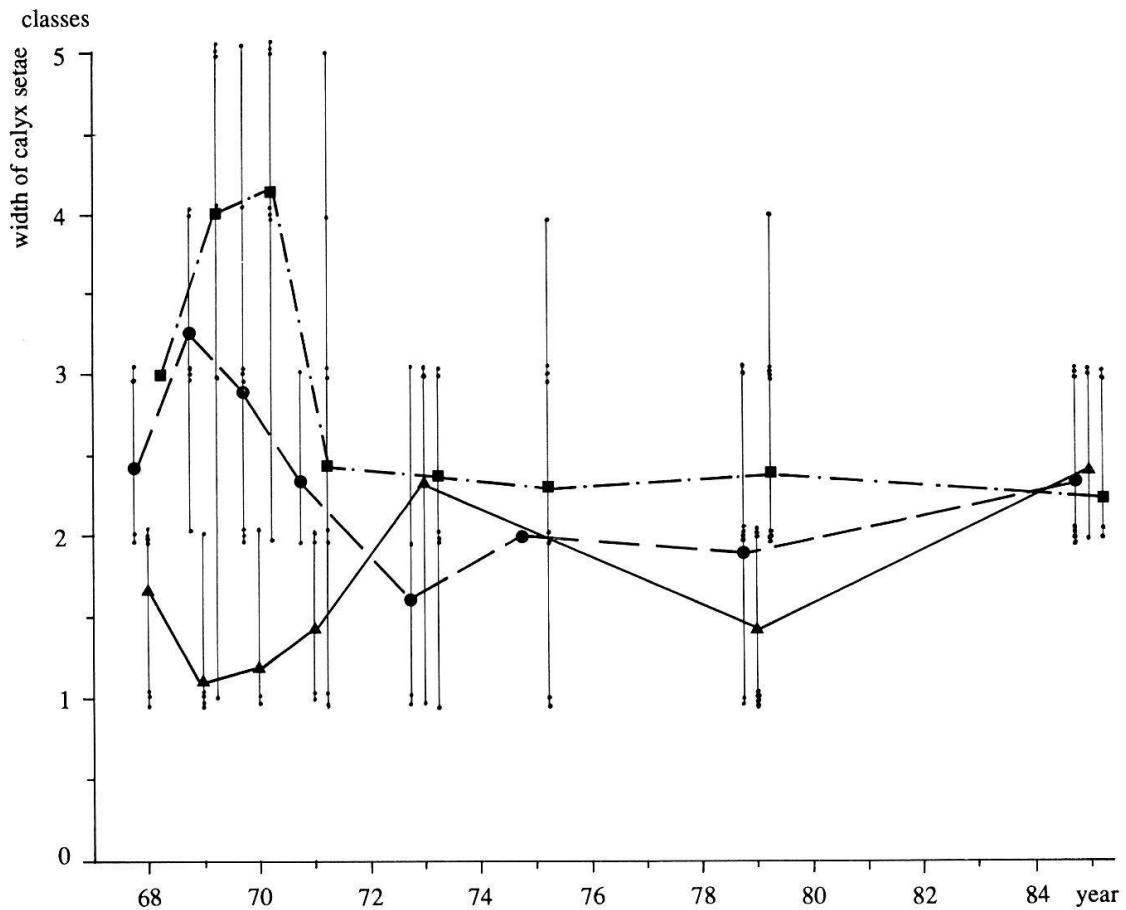

Fig. 11. Cool conditions - kühle Bedingungen

Figs. 11-13. Width of calyx setae of *Scabiosa* populations

Kelchborstenbreite von *Scabiosa*-Populationen

■ *S. lucida* ● *S. columbaria* ▲ *S. gramuntia* | total variation with individual values
★ mixed population

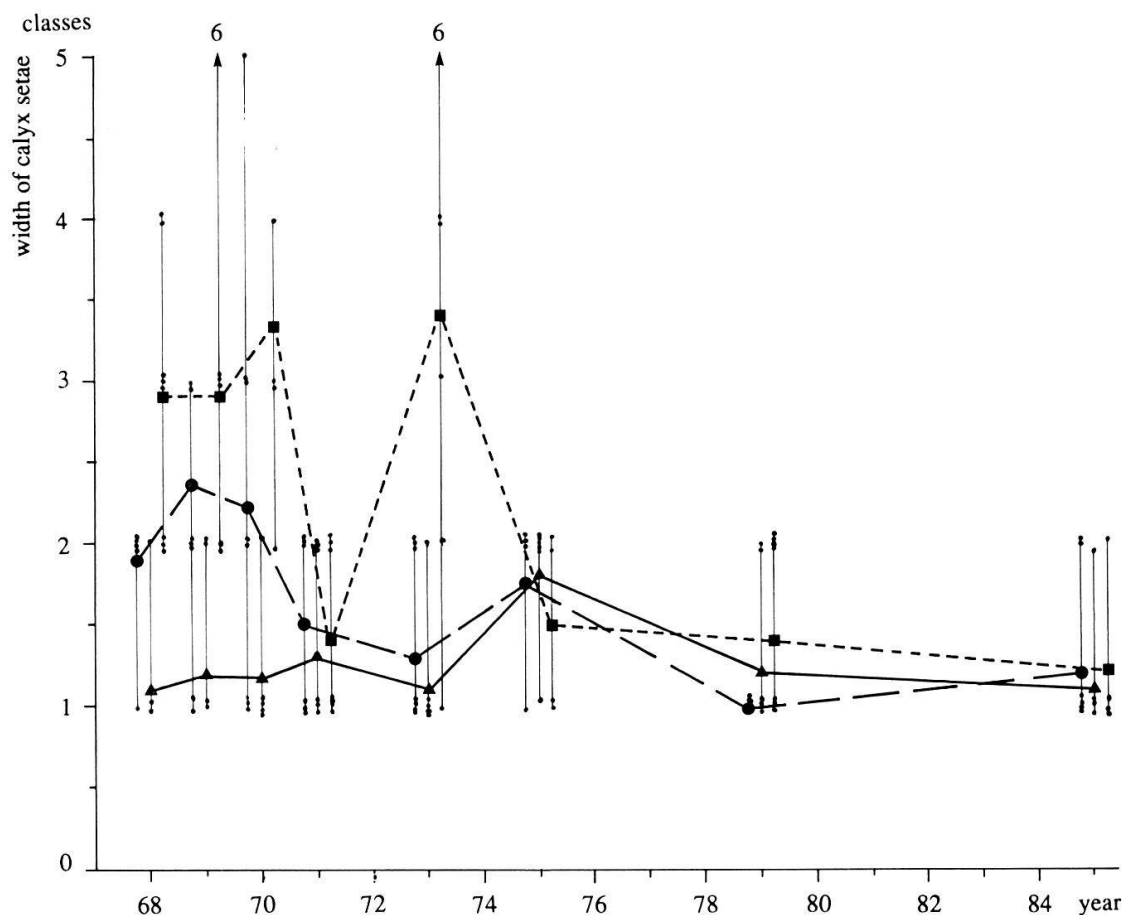

Fig. 12. Warm conditions - *warme Bedingungen*

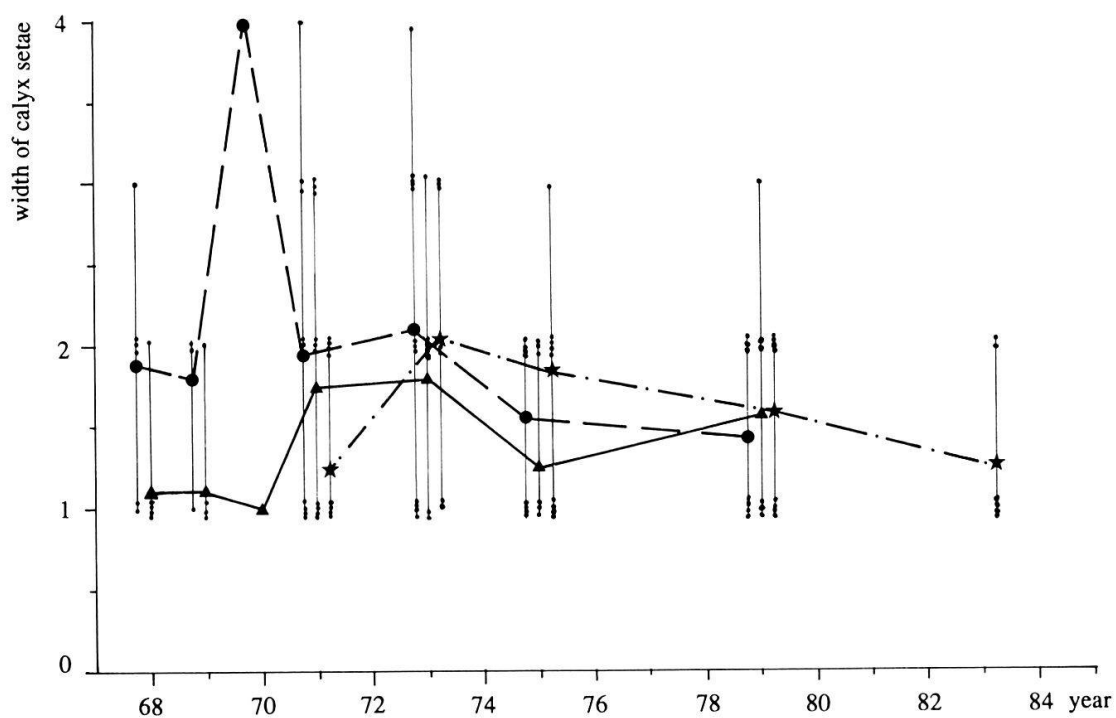

Fig. 13. Ground water plots with a water table level at 145 cm below the surface and well fertilized.

Grundwasserbecken mit einem Wasserstand von 145 cm unter Flur und stark gedüngt

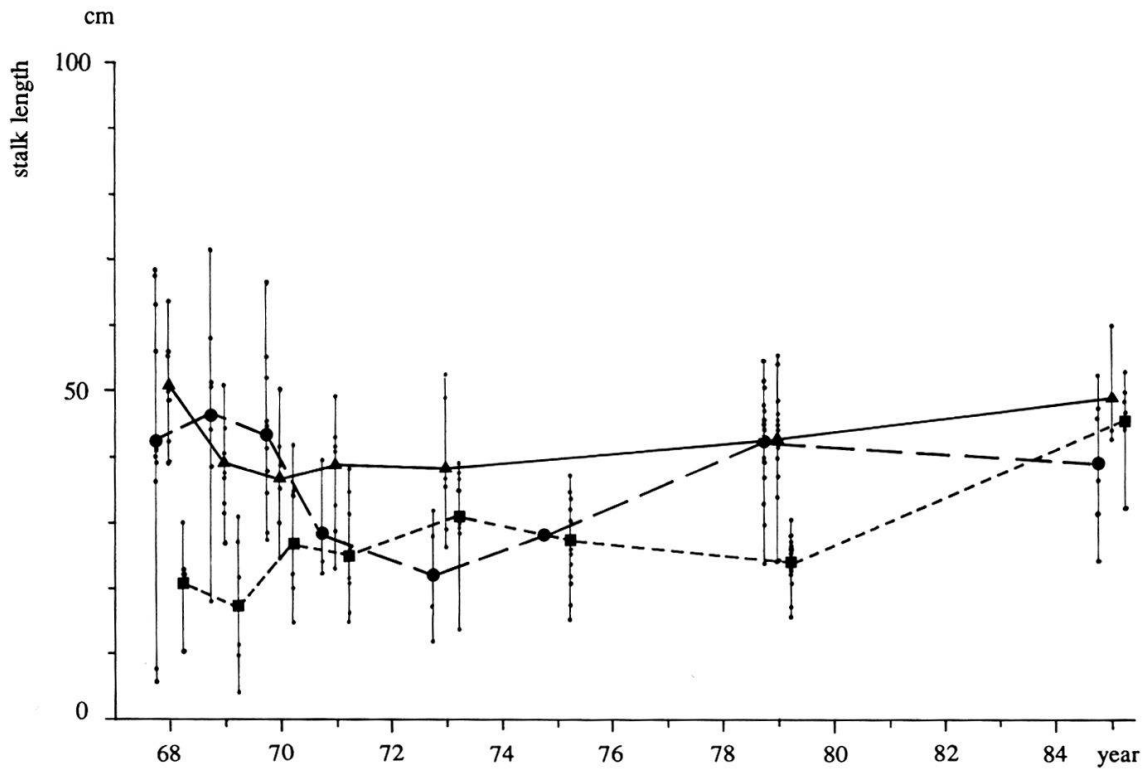

Fig. 14. Cool conditions - *kühle Bedingungen*

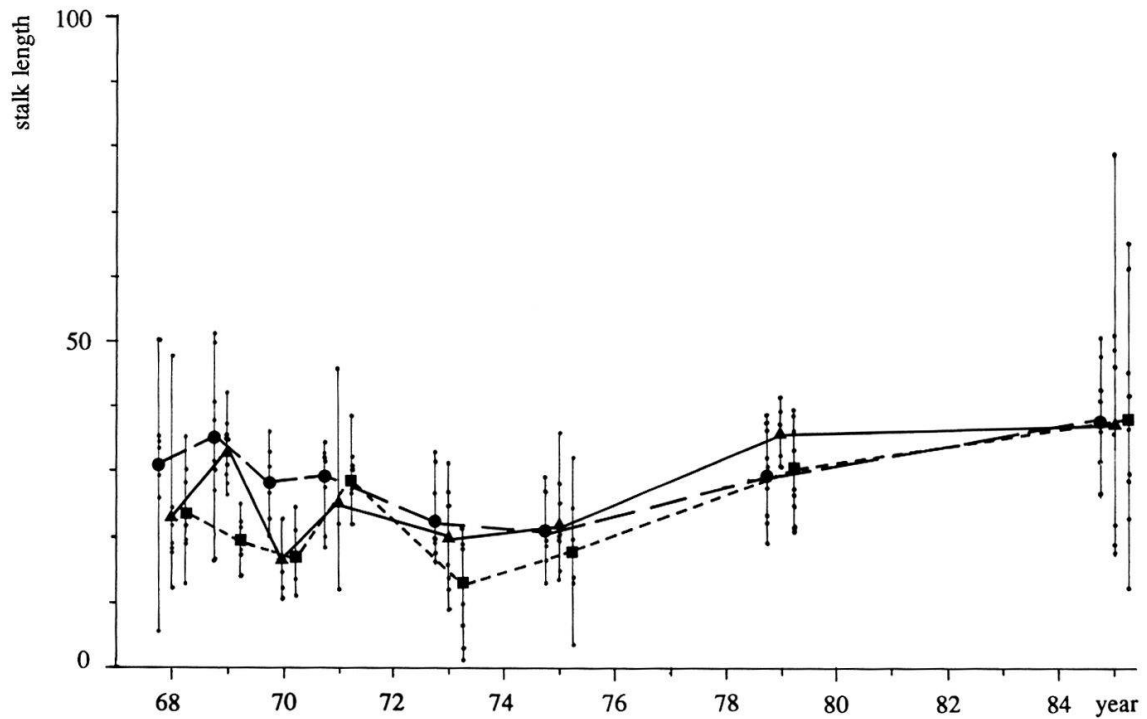

Fig. 15. Warm conditions - *warme Bedingungen*

Figs. 14-16. Stalk length of flower heads of *Scabiosa* populations
Länge des Blütenkopfstiels von Scabiosa-Populationen

■ *S. lucida* ● *S. columbaria* ▲ *S. gramuntia* † total variation with individual values
 ★ mixed population

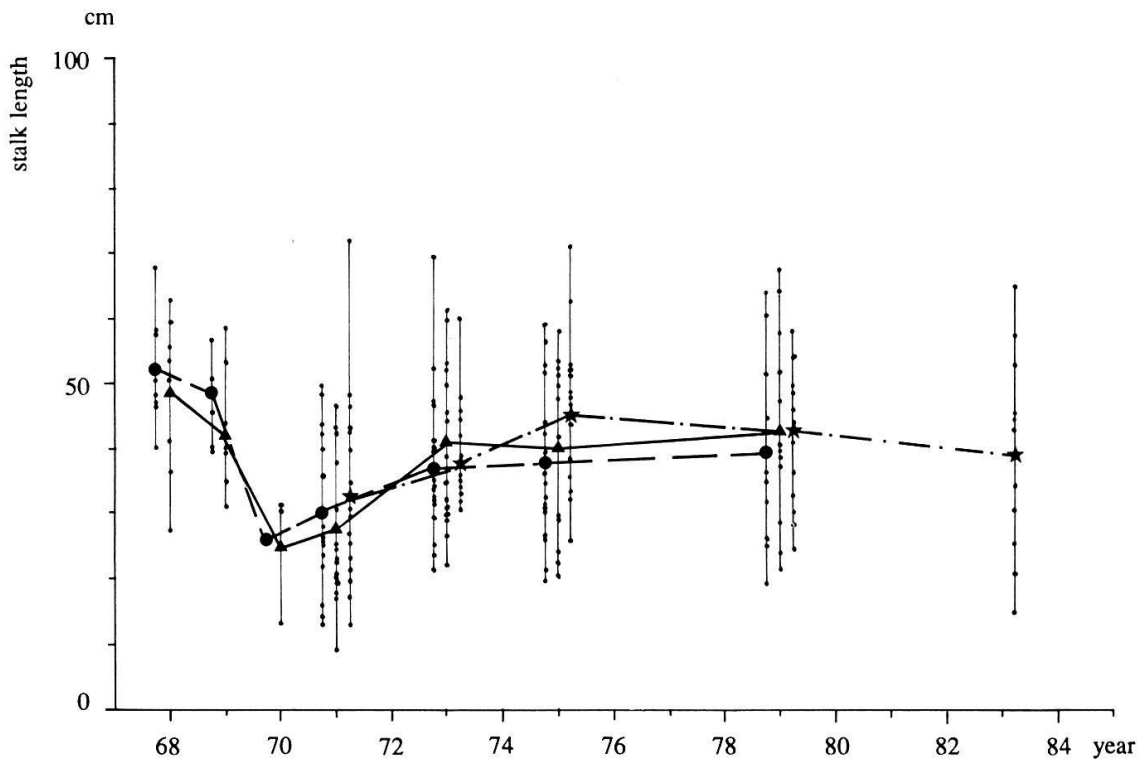

Fig. 16. Ground water plots with a water table level at 145 cm below the surface and well fertilized.

Grundwasserbecken mit einem Wasserstand von 145 cm unter Flur und stark gedüngt.

4.1.4. Stalk length of flowering heads (Figs. 14 to 16)

The stalk length varies widely, especially in *S. columbaria*. Also the yearly variation (1968 to 1970) is rather high (deviating up to 20% from the mean). The variation of the mixed population (from 1971 to 1985 and 1983, resp.) stays on a high level during the whole experiment.

The variation between different conditions is quite pronounced in *S. gramuntia* and a little less in *S. columbaria*. No variance was observed between the two temperature conditions of *S. lucida*. For *S. gramuntia* significant differences occur between cool (longer stalks) and warm conditions (Table 7), and for *S. columbaria* and *S. gramuntia* between well fertilized (longer stalks) and slightly fertilized or unfertilized conditions (Table 8). Within the last three years the mean values hardly changed anymore.

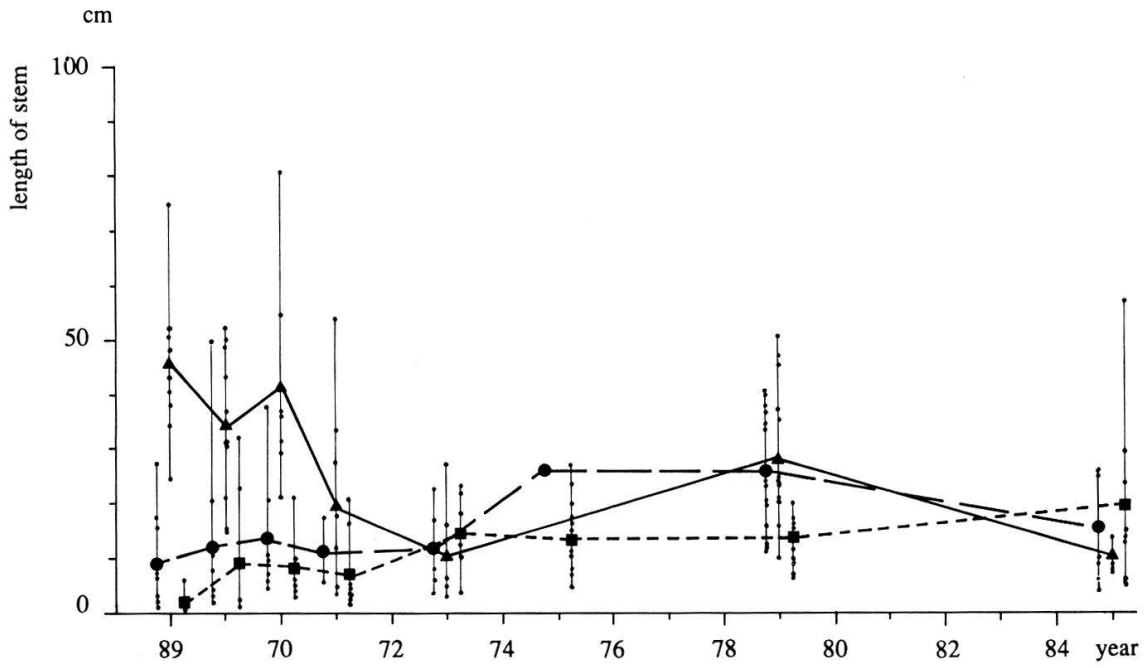

Fig. 17. Cool conditions - *kühle Bedingungen*

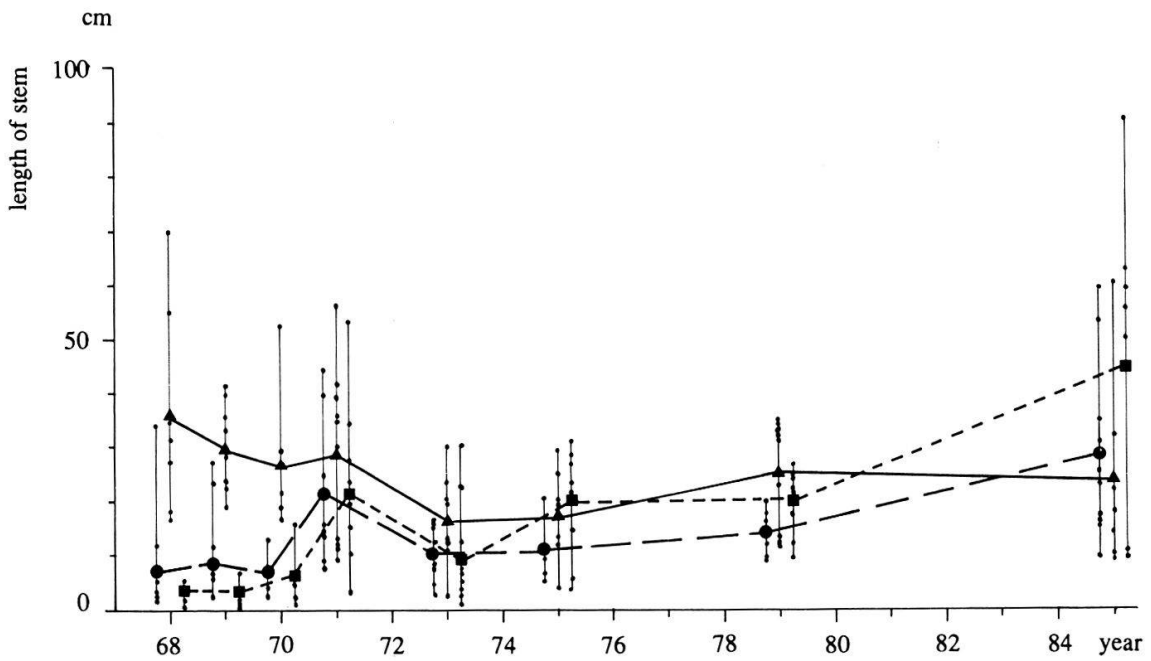

Fig. 18. Warm conditions - *warme Bedingungen*

Figs. 17-19. Length of stem of *Scabiosa* populations
Stengellänge von Scabiosa-Populationen

■ *S. lucida* ● *S. columbaria* ▲ *S. gramuntia* } total variation with individual values
 ★ mixed population

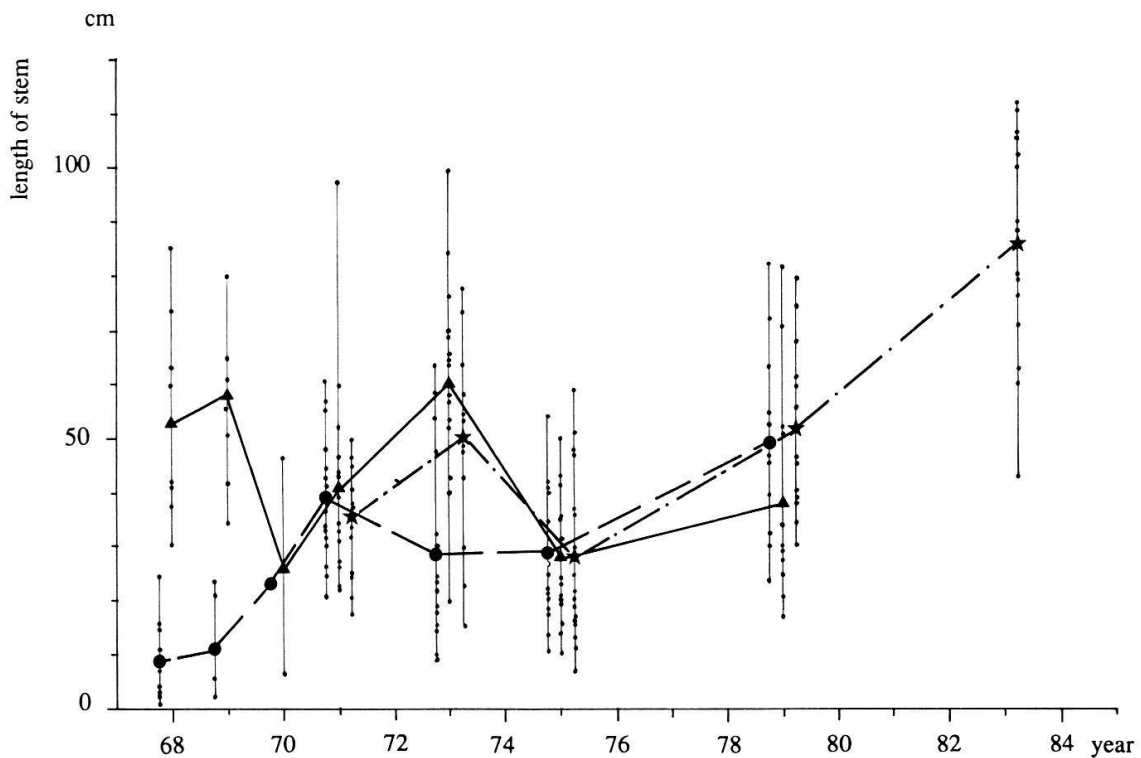

Fig. 19. Ground water plots with a water table level at 145 cm below the surface and well fertilized.

Grundwasserbecken mit einem Wasserstand von 145 cm unter Flur und stark gedüngt.

4.1.5. Length of stem (Figs. 17 to 19)

The stem length varies widely under all but cool conditions. This concerns the individuals within a population as well as the mean values for different years. The stem heights of *S. lucida* and *S. columbaria* in the greenhouse are nearly the same under both cool and warm conditions. On the other hand, the stem of *S. gramuntia* is longer under cool than under warm conditions.

There is still a pronounced difference between the two mean values of the last three years.

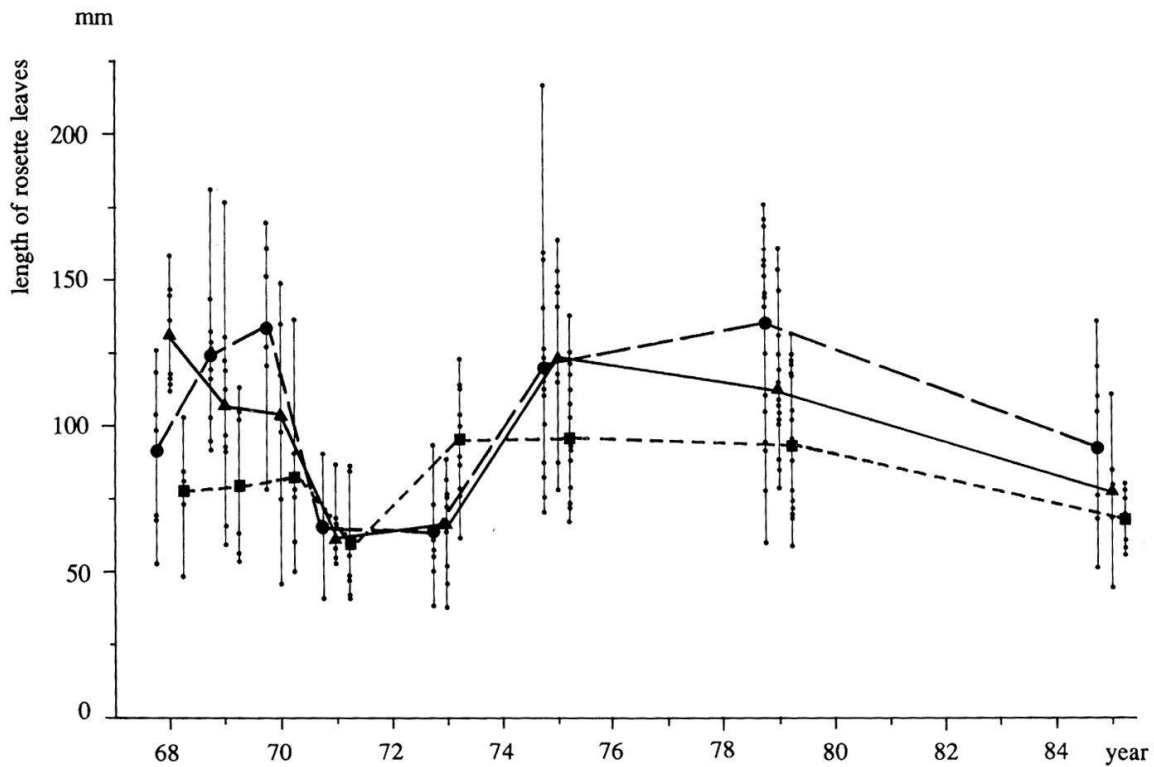

Fig. 20. Cool conditions - *kühle Bedingungen*

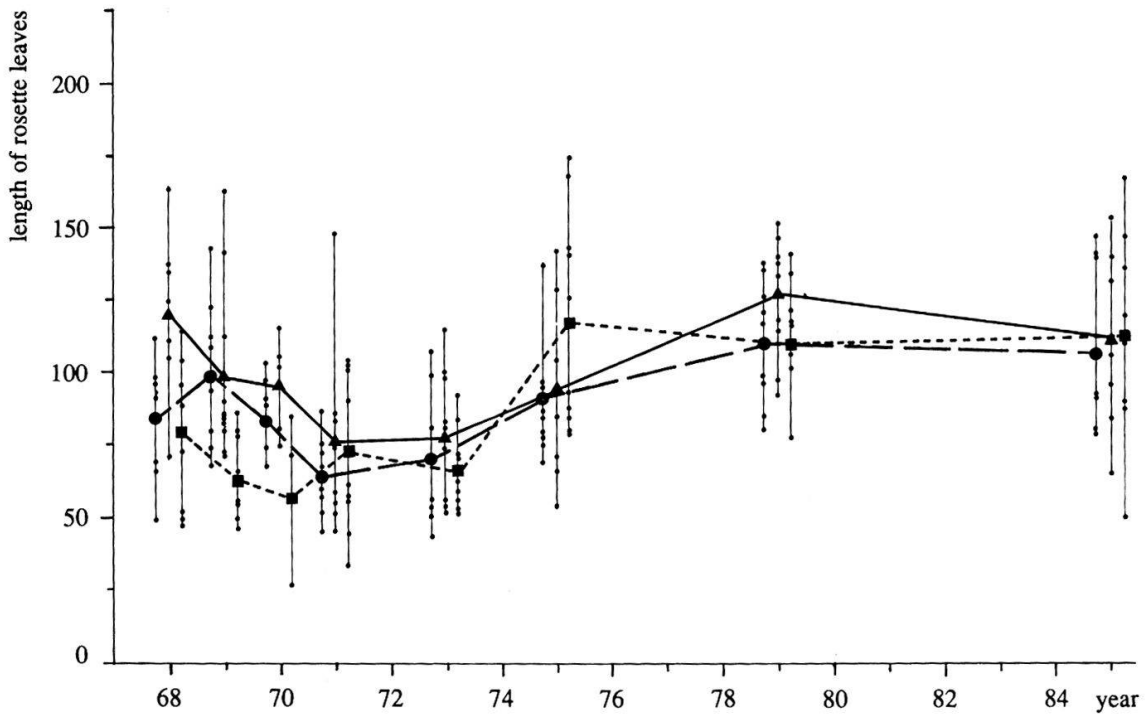

Fig. 21. Warm conditions - *warme Bedingungen*

Figs. 20-22. Length of rosette leaves of *Scabiosa* populations

Länge der Rosettenblätter von *Scabiosa*-Populationen

■ *S. lucida* ● *S. columbaria* ▲ *S. gramuntia* | total variation with individual values
 ★ mixed population

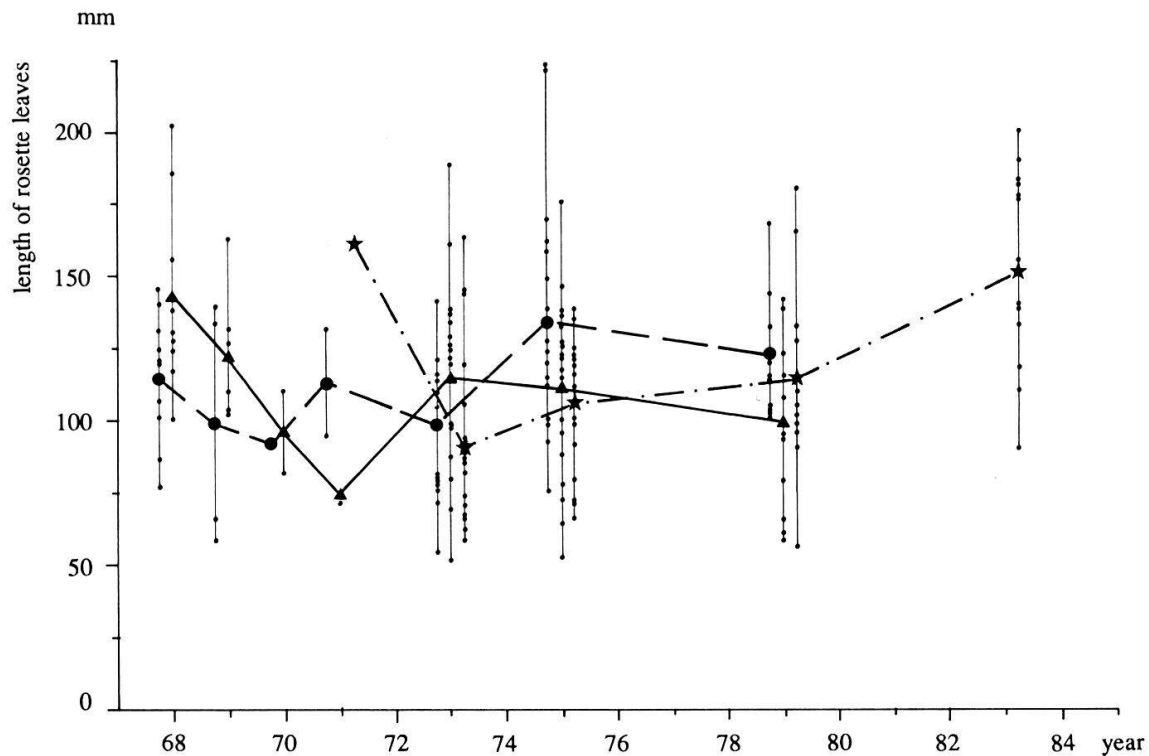

Fig. 22. Ground water plots with a water table level at 145 cm below the surface and well fertilized.
Grundwasserbecken mit einem Wasserstand von 145 cm unter Flur und stark gedüngt.

4.1.6. Length of rosette leaves (Figs. 20 to 22)

The variation of the leaf length is rather high in all three species reaching up to 50% deviation from the mean value. Also the yearly variation (1968 to 1970) is high.

Due to this high variation the differences in length between different conditions are statistically not always significant, though the tendency is clear: The leaves of *S. columbaria* and *S. gramuntia* are shorter under warm conditions than under cool ones, they are longer in well fertilized plots than in slightly or unfertilized ones. A watering interval of seven days also produces longer leaves than a 28 day interval.

The variability within the mixed populations is high and does not diminish during the experiment. Also the difference of the mean values between the last three years is remarkable, the values being higher under normal rain watering and lower under all experimental watering conditions.

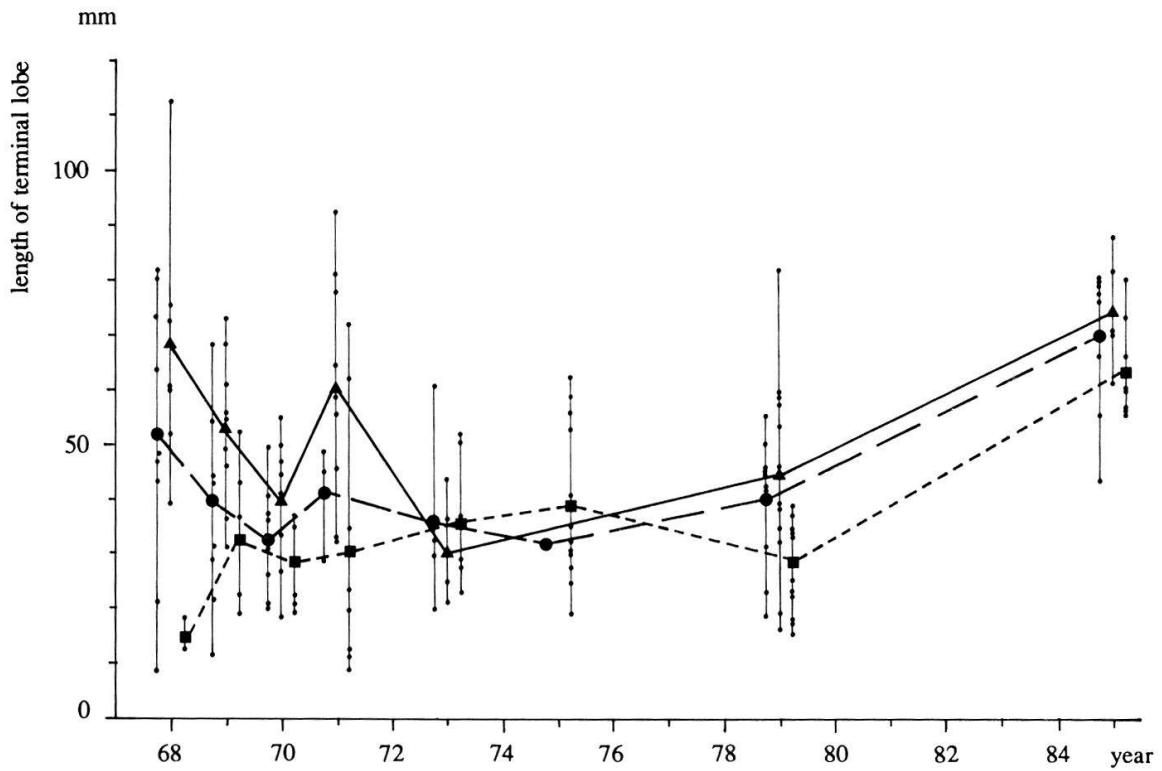

Fig. 23. Cool conditions - *kühle Bedingungen*

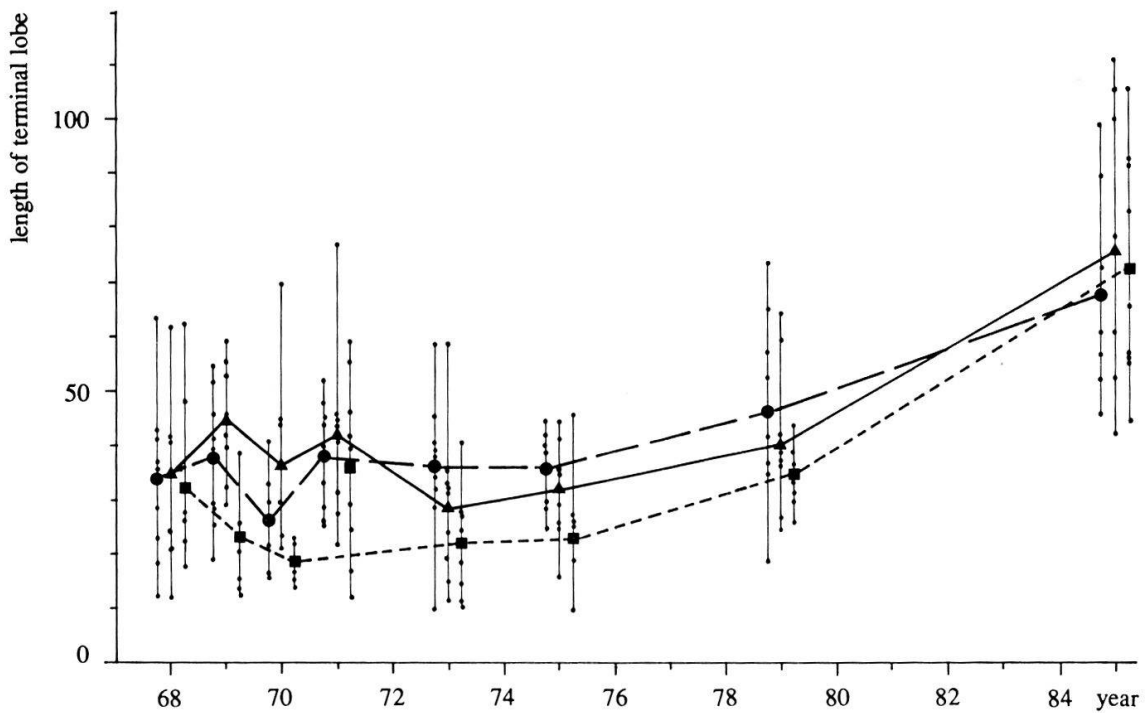

Fig. 24. Warm conditions - *warme Bedingungen*

Figs. 23-25. Length of the terminal lobe of the uppermost cauline leaf of *Scabiosa* populations - *Länge des Endabschnittes des obersten Stengelblattes von Scabiosa-Populationen*
 ■ *S. lucida* ● *S. columbaria* ▲ *S. gramuntia* } total variation with individual values
 ★ mixed population

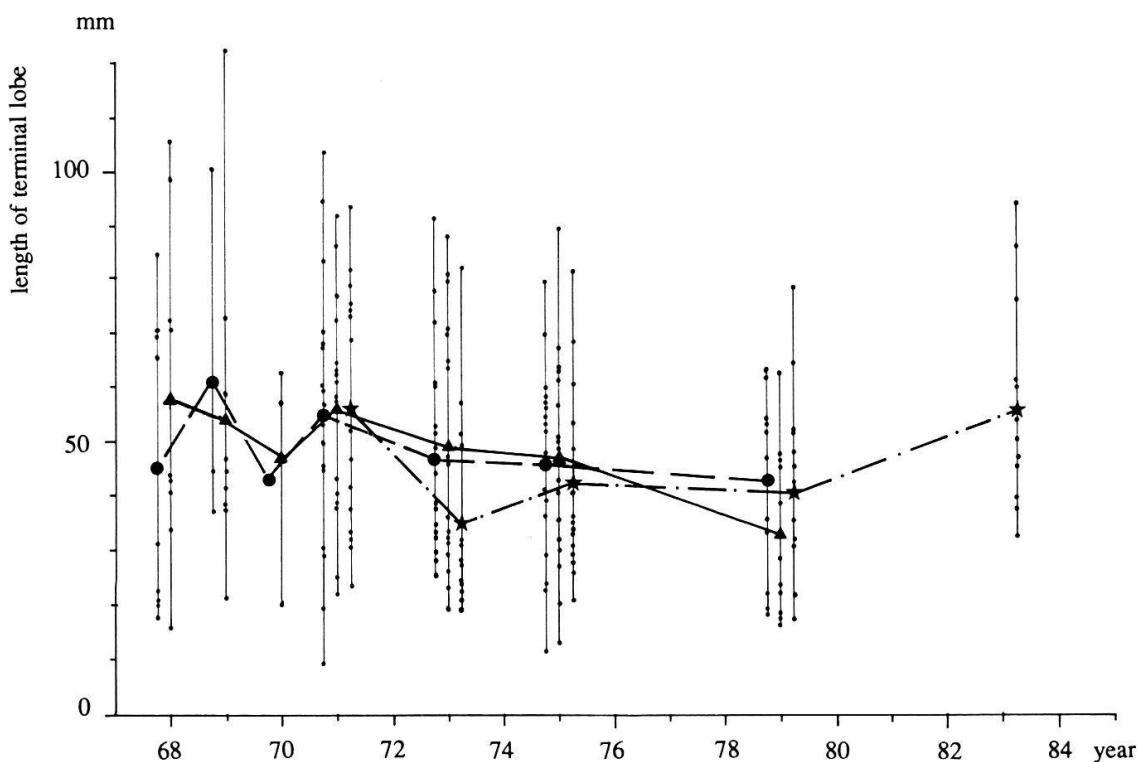

Fig. 25. Ground water plots with a water table level at 145 cm below the surface and well fertilized.

Grundwasserbecken mit einem Wasserstand von 145 cm unter Flur und stark gedüngt.

4.1.7. Length of the terminal lobe of upper cauline leaves (Figs. 23 to 25)

The variation of the length of the terminal lobe is high within the same species as well within different years (up to 100% deviation from the mean value).

Under warm conditions the lobe is shorter for *S. columbaria* (insignificant) and for *S. gramuntia* than under cool conditions. Contrary, *S. lucida* develops longer leaves under warm conditions (difference insignificant). In the well fertilized plots the lobe is longer than in slightly or unfertilized ones.

The variability at the beginning of the experiment was slightly higher than at the end. A pronounced difference between the mean values of the last three years can be observed in the greenhouse..

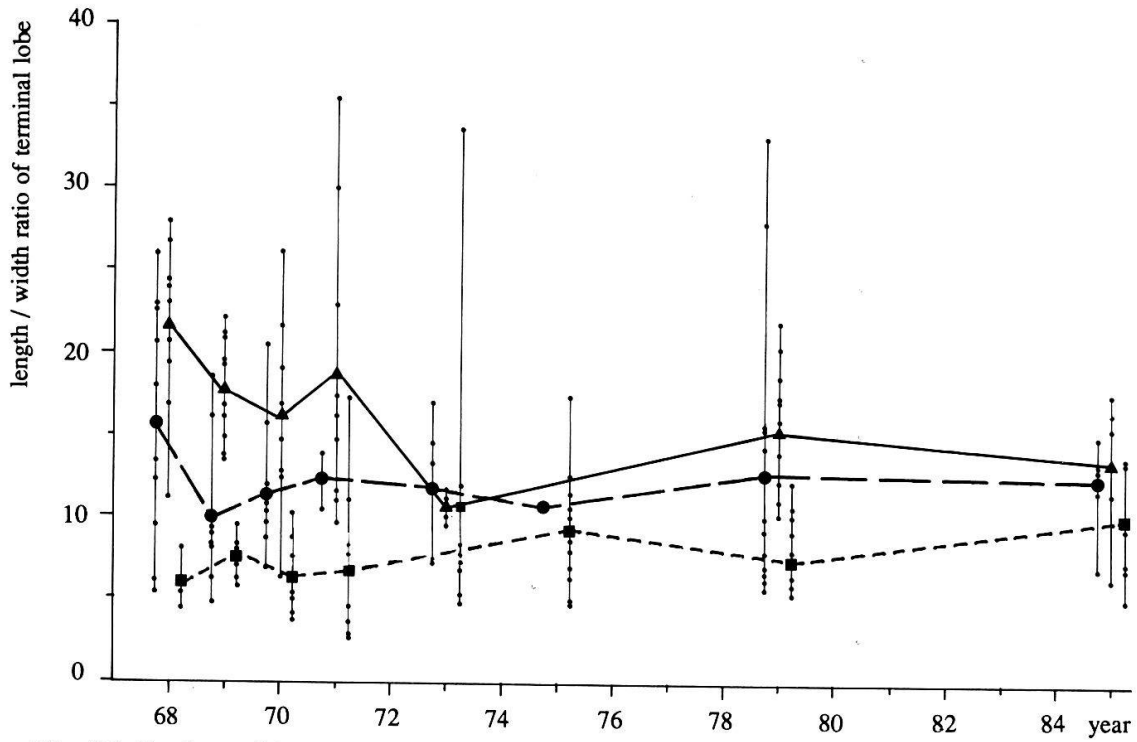

Fig. 26. Cool conditions - *kühle Bedingungen*

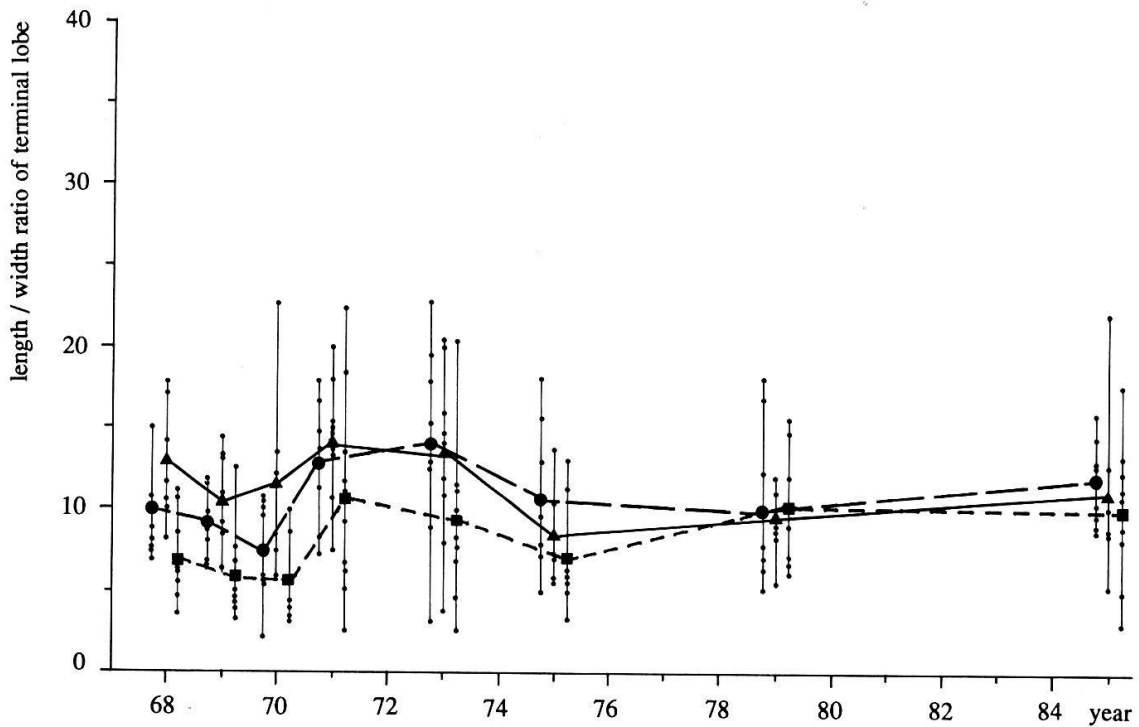

Fig. 27. Warm conditions - *warme Bedingungen*

Figs. 23-25. Length/width ratio of the terminal lobe of the uppermost cauline leaf of *Scabiosa* populations - *Längen/Breitenverhältnis des Endabschnittes des obersten Stengelblattes von Scabiosa-Populationen*

■ *S. lucida* ● *S. columbaria* ▲ *S. gramuntia* | total variation with individual values
 ★ mixed population

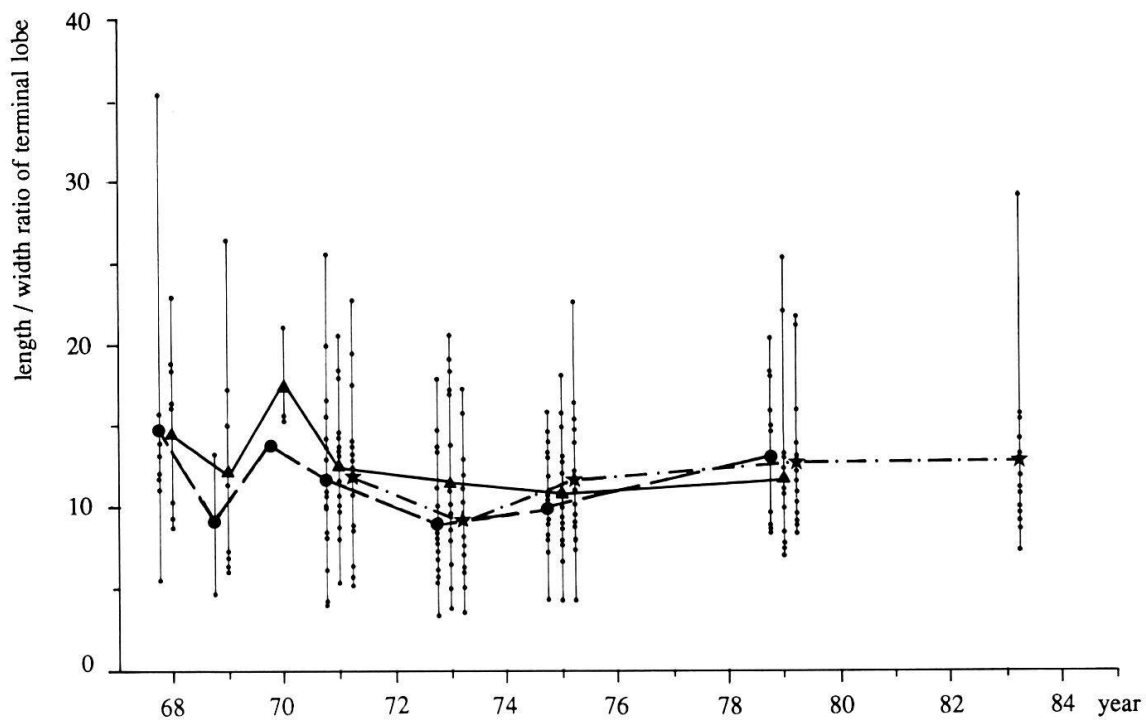

Fig. 28. Ground water plots with a water table level at 145 cm below the surface and well fertilized.
Grundwasserbecken mit einem Wasserstand von 145 cm unter Flur und stark gedüngt.

4.1.8. Length/width ratio of the terminal lobe of the uppermost cauline leaf (Figs. 26 to 28)

There is a rather high variability under each condition within a species. Also the yearly variation is remarkable. *S. columbaria* and *S. gramuntia* show a clearly lower ratio under warm than under cool conditions. No other variation between different conditions is recognizable.

The variability of the mixed populations was slightly higher at the beginning of the experiment than at the end. The difference between the mean values of the last three years is rather small even where the difference of the lobe length is pronounced.

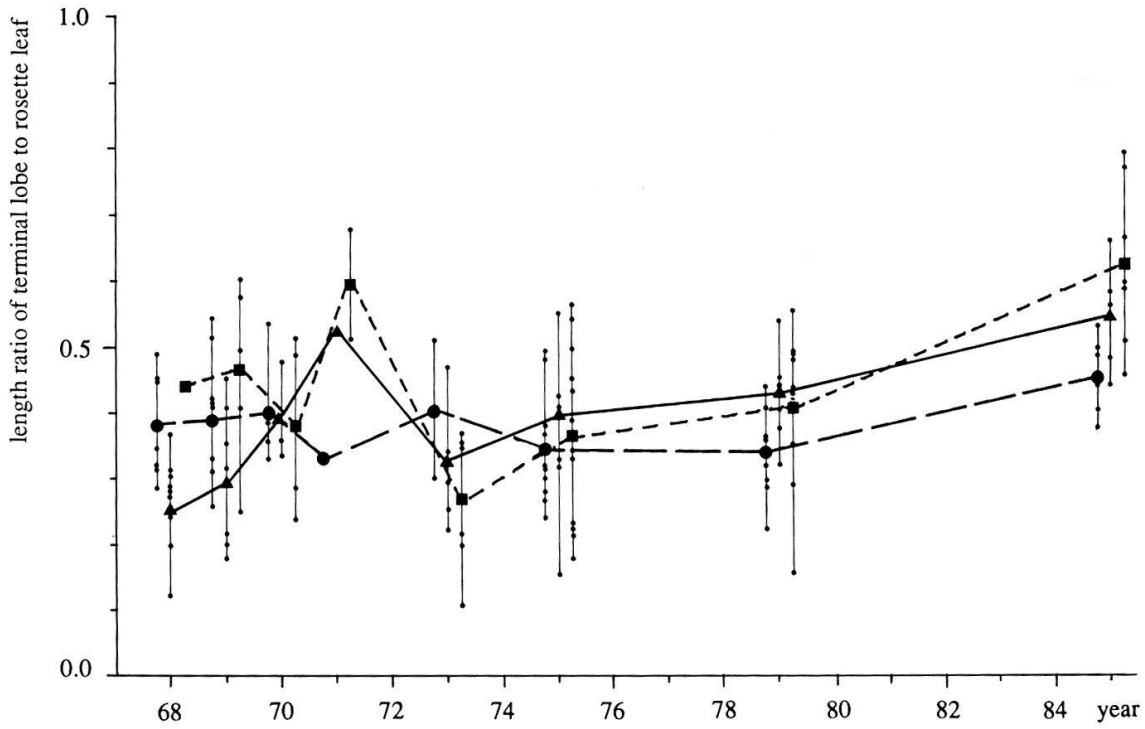

Fig. 29. Cool conditions - kühle Bedingungen

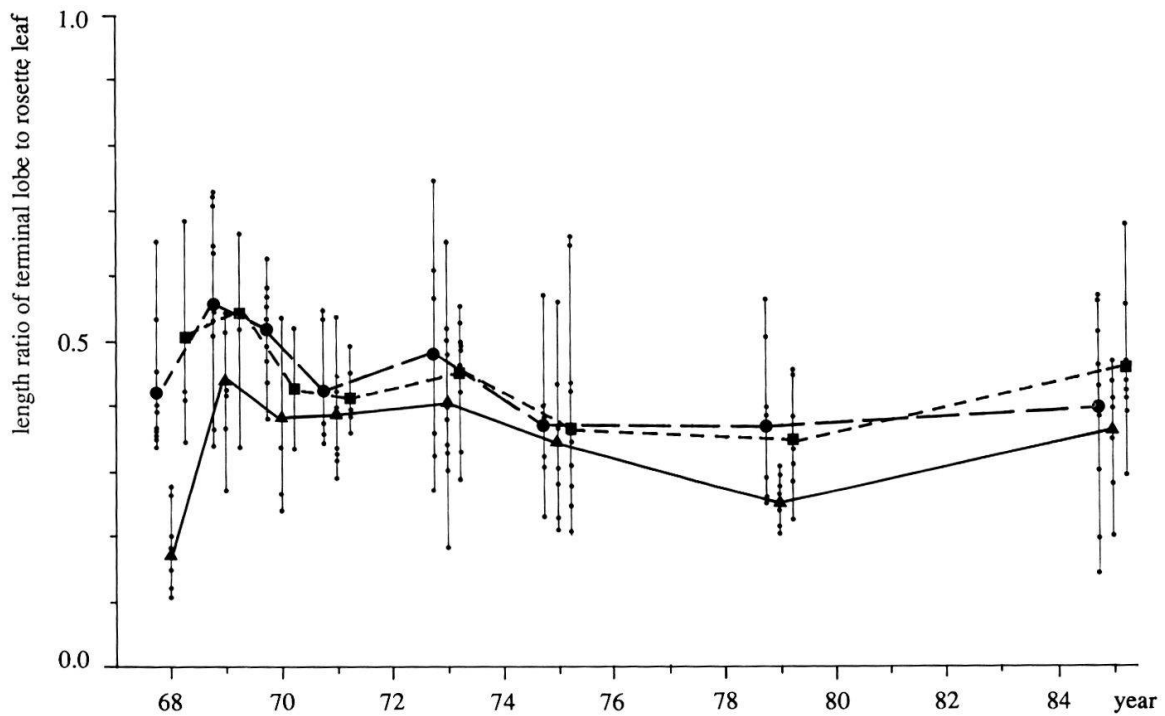

Fig. 30. Warm conditions - warme Bedingungen

Figs. 29-31. Length ratio of the terminal lobe of the uppermost rosette leaf to the rosette leaf of *Scabiosa* populations - Längenverhältnis des Endabschnittes des obersten Rosettenblattes zum Rosettenblatt von *Scabiosa*-Populationen

■ *S. lucida* ● *S. columbaria* ▲ *S. gramuntia* } total variation with individual values
 ★ mixed population

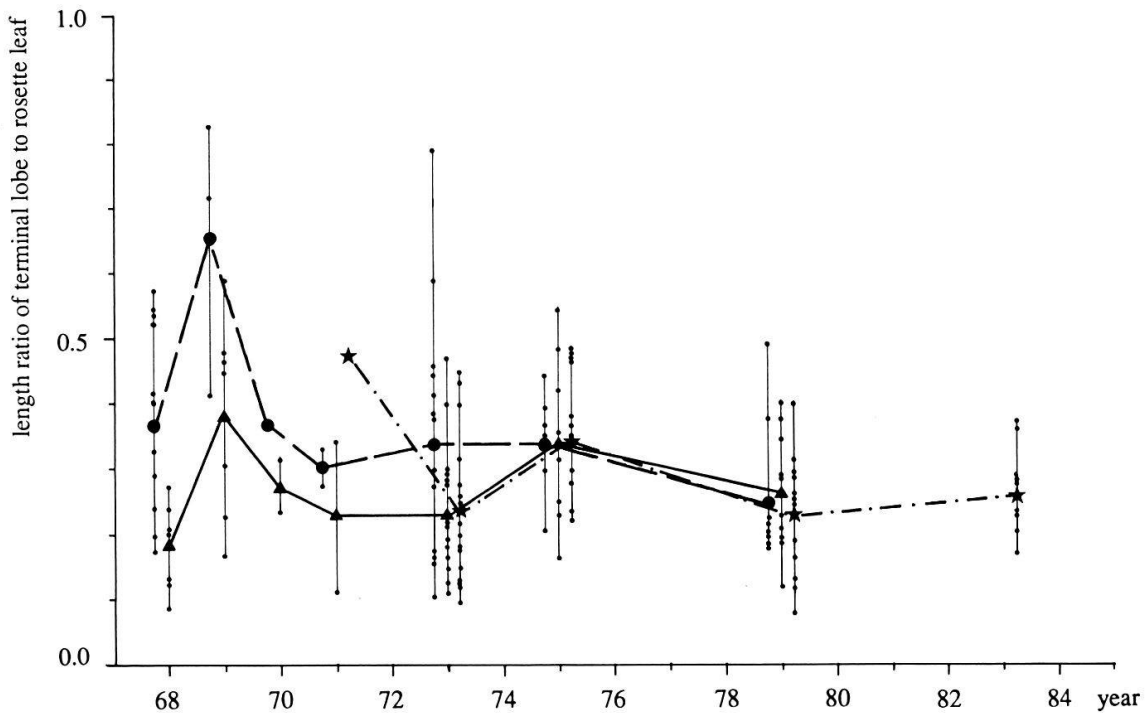

Fig. 31. Ground water plots with a water table level at 145 cm below the surface and well fertilized.

Grundwasserbecken mit einem Wasserstand von 145 cm unter Flur und stark gedüngt.

4.1.9. Length ratio of the terminal lobe of the uppermost rosette leaf to the rosette leaf (Figs. 29 to 31)

The individual variation of the ratio within the species as well as between the years is rather high.

The ratio is smaller for *S. gramuntia* under warm than under cool conditions, under well fertilized than under unfertilized conditions, and under normal watering conditions than under watering intervals of 28 days.

The variability of the mixed populations scarcely decreased during the experiment.

4.2. Morphological differentiation under different conditions

4.2.1. Hair density (Fig. 32)

Under most conditions the hair density at the end of the experiment is similar to *S. columbaria*. The values are distinctly higher under well fertilized conditions and under controlled watering.

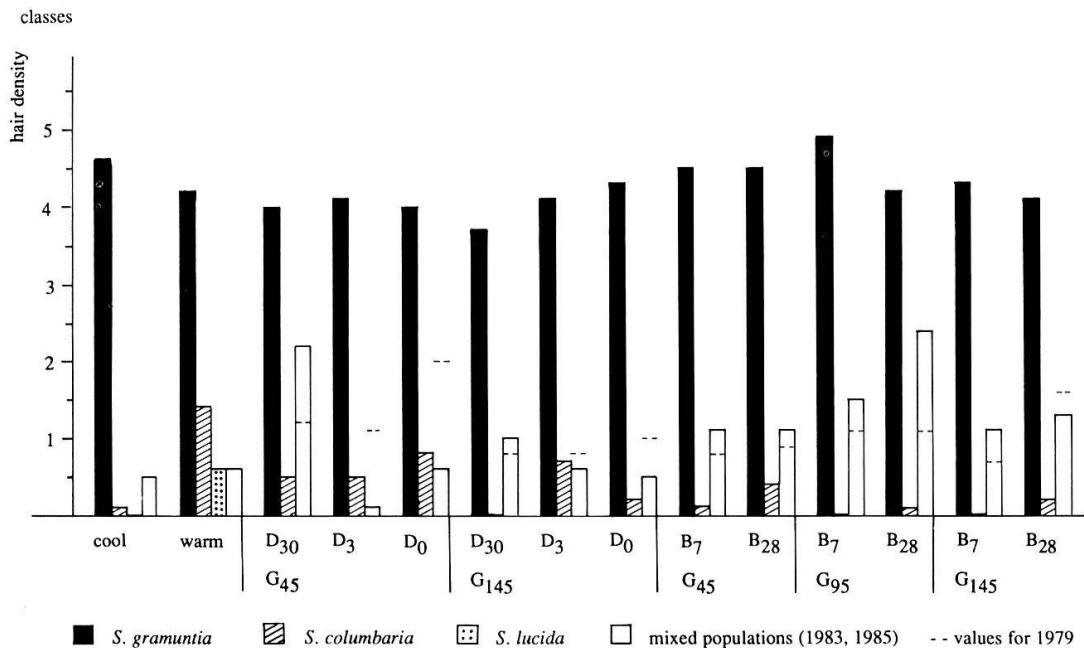

Fig. 32. Hair density on rosette leaves of *Scabiosa* populations under different conditions. *Haardichte der Rosettenblätter von Scabiosa-Populationen unter verschiedenen Bedingungen.*

D = intensity of fertilization corresponding to g nitrogen per m² and year

G = depth of water table level in cm

B = watering intervals in days

4.2.2. Length of calyx setae (Fig. 33)

The length of calyx setae is under most conditions intermediate but nearer to *S. gramuntia* than to *S. columbaria*. The only clear exception is observed under cool conditions in the greenhouse where the setae are even longer than in *S. columbaria*.

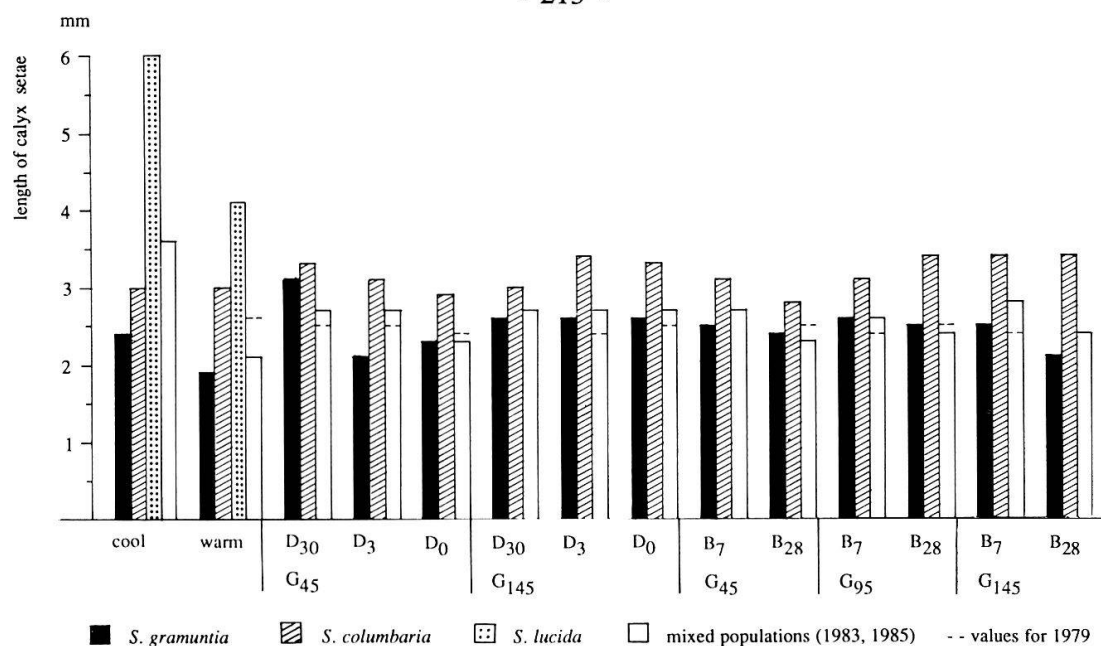

Fig. 33. Length of calyx setae of *Scabiosa* populations under different conditions.
Kelchborstenlänge von Scabiosa-Populationen unter verschiedenen Bedingungen.
 D = intensity of fertilization corresponding to g nitrogen per m² and year
 G = depth of water table level in cm
 B = watering intervals in days

4.2.3. Width of calyx setae (Fig. 34)

Similarly to the length of calyx setae the width is mostly intermediate but nearer to *S. gramuntia*. Also, as with the length of setae, the width is similar to *S. columbaria* under cool conditions. In plots with a low water table level and long watering intervals the setae are even narrower than in *S. gramuntia*.

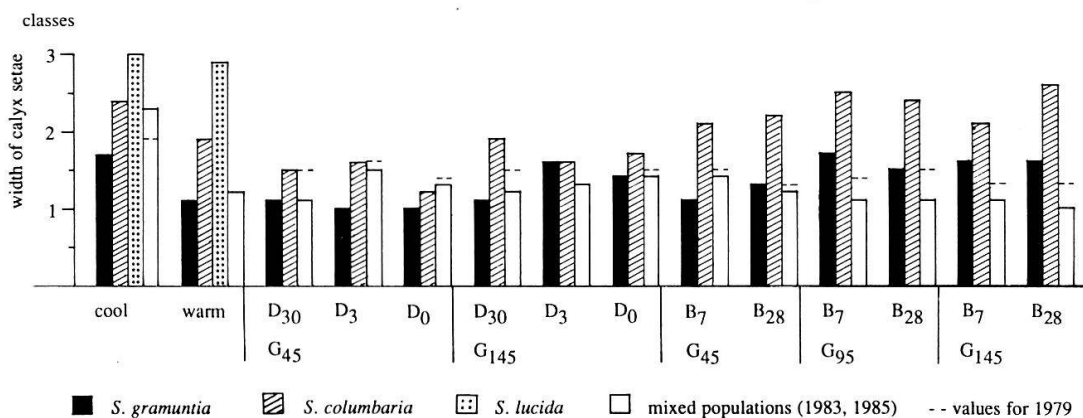

Fig. 34. Width of calyx setae of *Scabiosa* populations under different conditions.
Kelchborstenbreite von Scabiosa-Populationen unter verschiedenen Bedingungen.
 D = intensity of fertilization corresponding to g nitrogen per m² and year
 G = depth of water table level in cm
 B = watering intervals in days

4.2.4. Stalk length of flowering heads (Fig. 35)

In the ground water plots towards the end of the experiment the stalk is always shorter than either *S. columbaria* or *S. gramuntia* in 1968. Under warm conditions it is longer than in the original populations of all three species, under cool conditions it is similar to *S. columbaria*.

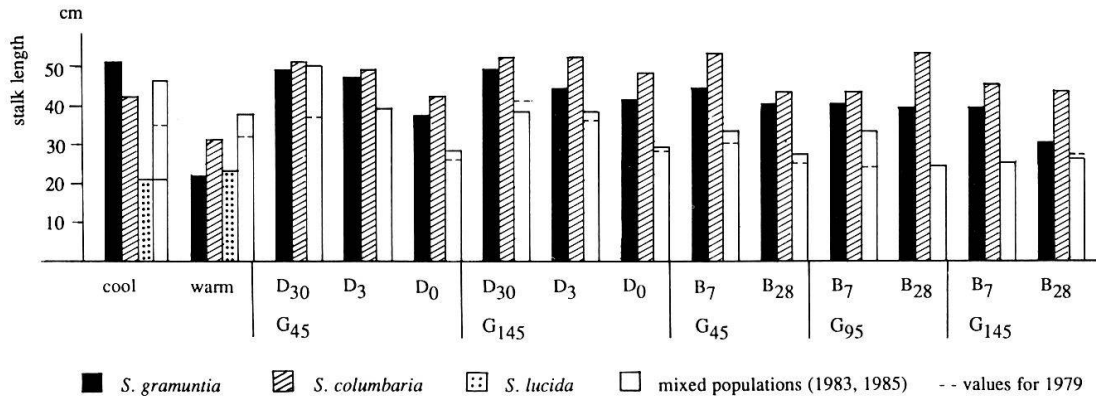

Fig. 35. Stalk length of flower heads of *Scabiosa* populations under different conditions.
Länge des Blütenkopfstiels von Scabiosa-Populationen unter verschiedenen Bedingungen.
 D = intensity of fertilization corresponding to g nitrogen per m² and year
 G = depth of water table level in cm
 B = watering intervals in days

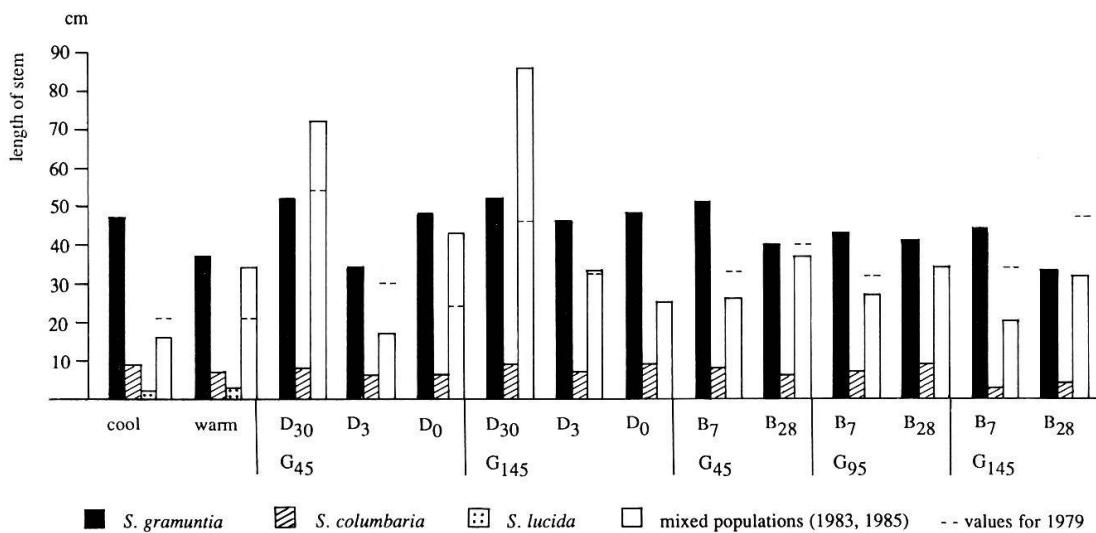

Fig. 36. Length of stem of *Scabiosa* populations under different conditions.
Stengellänge von Scabiosa-Populationen unter verschiedenen Bedingungen.
 D = intensity of fertilization corresponding to g nitrogen per m² and year
 G = depth of water table level in cm
 B = watering intervals in days

4.2.5. Length of stem (Fig. 36)

The stem length of the final populations is under most conditions somewhere between *S. columbaria* and *S. gramuntia*. Under dry and warm conditions it is nearer to *S. gramuntia*, under cool and moist conditions it is more similar to *S. columbaria*. Under well fertilized conditions the stems become even higher than in *S. gramuntia*.

4.2.6. Length of rosette leaves (Fig. 37)

Under most conditions the leaf length is similar to that of *S. columbaria*. Under very dry conditions (low water table and long watering intervals) the leaf is longer than in *S. columbaria*. The same is true under well fertilized conditions. In the warm greenhouse the length is similar to *S. gramuntia*, in the cool one similar to *S. lucida*.

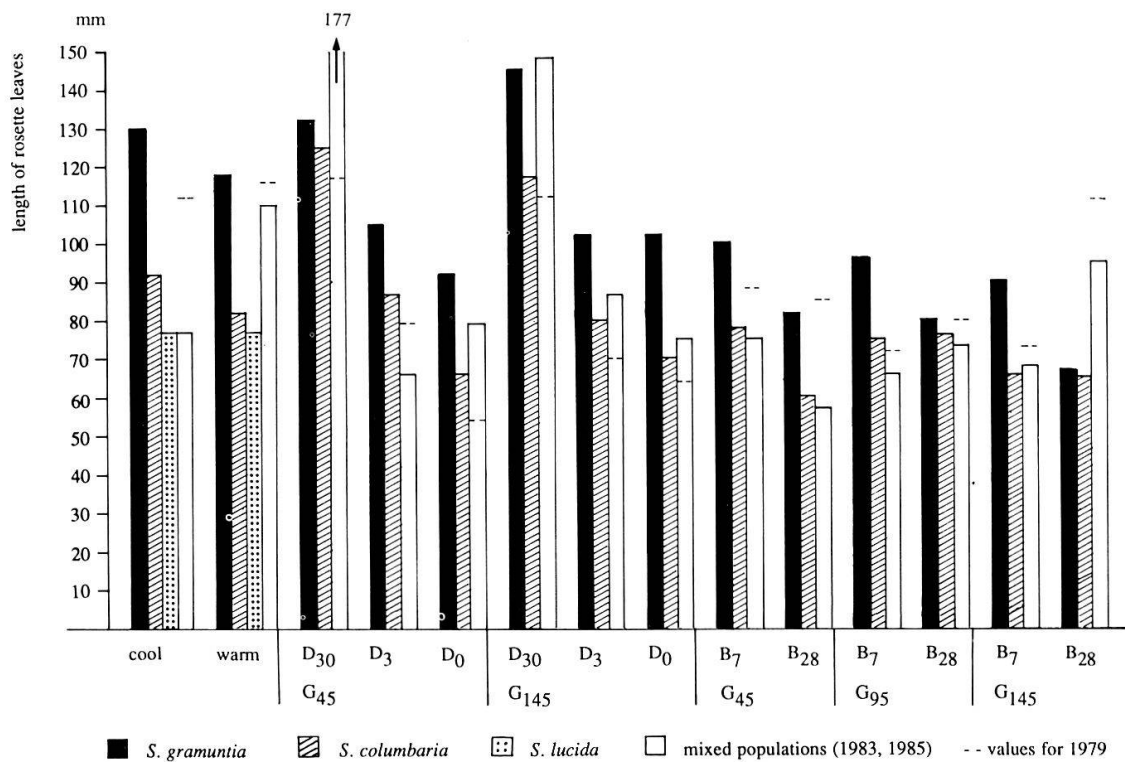

Fig. 37. Length of rosette leaves of *Scabiosa* populations under different conditions.
Länge der Rosettenblätter von Scabiosa-Populationen unter verschiedenen Bedingungen.
 D = intensity of fertilization corresponding to g nitrogen per m² and year
 G = depth of water table level in cm
 B = watering intervals in days

4.2.7. Length of terminal lobe of the uppermost cauline leaf (Fig. 38)

The lobe length of plants from dry and from unfertilized plots is similar to *S. columbaria* or even shorter. In well fertilized plots and under cool conditions in the greenhouse it is similar to *S. gramuntia*. In the warm greenhouse it became much longer than in all the original populations of the three species.

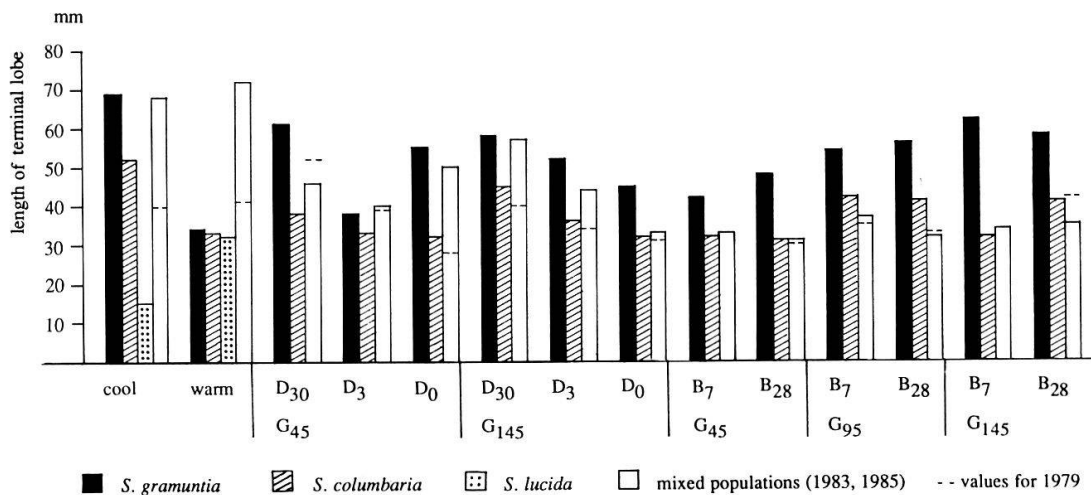

Fig. 38. Length of the terminal lobe of the uppermost cauline leaf of *Scabiosa* populations under different conditions.

Länge des Endabschnittes des obersten Stengelblattes von Scabiosa-Populationen unter verschiedenen Bedingungen.

D = intensity of fertilization corresponding to g nitrogen per m² and year

G = depth of water table level in cm

B = watering intervals in days

4.2.8. Length/width ratio of the terminal lobe of the uppermost cauline leaf (Fig. 39)

The length/width ratio of the final population lies in most series between *S. columbaria* and *S. gramuntia*. In well fertilized plots it is similar to *S. gramuntia*. In the cool greenhouse it is even lower than for *S. lucida*.

4.2.9. Length ratio of terminal lobe of the uppermost rosette leaf to rosette leaf (Fig.40)

The ratio in the final populations is mostly between *S. columbaria* and *S. gramuntia* except under long watering intervals where it is lower than in *S. gramuntia*. In the cool greenhouse the ratio is about the same as in *S. lucida*.

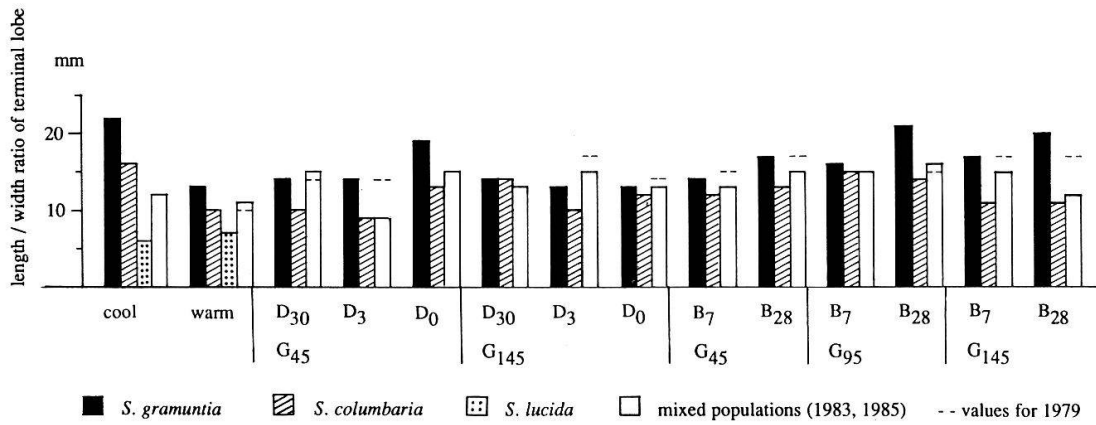

Fig. 39. Length/width ratio of the terminal lobe of the uppermost cauline leaf of *Scabiosa* populations under different conditions.

Längen/Breitenverhältnis des Endabschnittes des obersten Stengelblattes von Scabiosa-Populationen unter verschiedenen Bedingungen.

D = intensity of fertilization corresponding to g nitrogen per m² and year

G = depth of water table level in cm

B = watering intervals in days

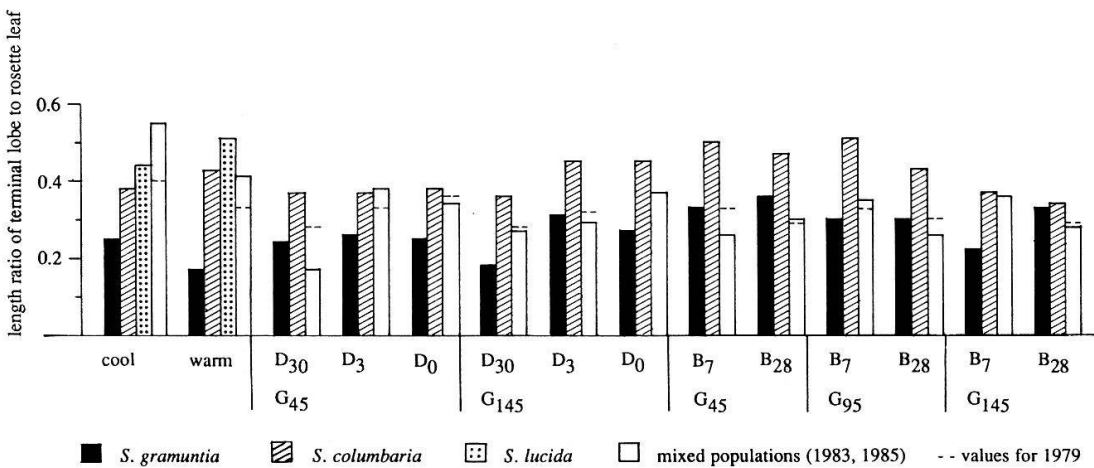

Fig. 40. Length ratio of the terminal lobe of the uppermost cauline leaf to the rosette leaf of *Scabiosa* populations under different conditions.

Längenverhältnis des Endabschnittes des obersten Stengelblattes zum Rosettenblatt von Scabiosa-Populationen unter verschiedenen Bedingungen.

D = intensity of fertilization corresponding to g nitrogen per m² and year

G = depth of water table level in cm

B = watering intervals in days

4.3. The influence of different conditions

4.3.1. Temperature

The combinations of characteristics of the plants of the final populations (1985) under warm and cool conditions compared with the original species populations are shown in Table 9.

The plants of the final population in the cool greenhouse chamber have two characteristics (out of nine tested) similar to *S. lucida*, two intermediate between *S. lucida* and *S. columbaria*, two similar to *S. columbaria*, two intermediate between *S. columbaria* and *S. gramuntia* and one similar to *S. gramuntia*. Under warm conditions two characteristics of the plants are similar to *S. columbaria*, three intermediate between *S. columbaria* and *S. gramuntia* and two similar to *S. gramuntia*. Two characteristics are outside of the range of the three species.

Table 9. Characteristics of the final populations under different temperature conditions compared with the original (parent) species.

Eigenschaften der Endpopulationen unter verschiedenen Temperaturen verglichen mit den ursprünglichen Elterarten.

col = *S. columbaria*
 gram = *S. gramuntia*
 luc = *S. lucida*

col-gram = between *S. columbaria* and *S. gramuntia*
 col-luc = between *S. columbaria* and *S. lucida*

Characteristics	Temperature conditions	
	cool	warm
hair density	col (= luc)	col (= luc)
length of calyx setae	col-luc	col-gram
width of calyx setae	col-gram	gram
stalk length of flower heads	col	different
length of stem	col-gram	gram
length of rosette leaves	luc	col-gram
length of terminal lobe	gram	different
length/width ratio	col-luc	col-gram
terminal lobe/rosette leaf	luc	col

4.3.2. Fertilization

In Table 10, the morphological characteristics of the final populations are compared with the original populations of the different species.

Table 10. Morphological characteristics of the final populations of *Scabiosa* under different conditions compared with the original populations of the studied species.

Morphologische Eigenschaften der Endpopulationen unter verschiedenen Bedingungen, verglichen mit den ursprünglichen Populationen der untersuchten Arten.

col = *S. columbaria* col-gram = between *S. columbaria* and *S. gramuntia*
 gram = *S. gramuntia* gram + = more extreme than *S. gramuntia*
 luc = *S. lucida*

Characteristics	Conditions	
	well fertilized	unfertilized
hair density	col-gram	col
length of calyx setae	gram	gram
width of calyx setae	gram	gram
stalk length of flower heads	gram +	gram +
stem length	gram +	col-gram
length of rosette leaves	gram	col-(gram)
length of terminal lobe	col-(gram)	col
length/width ratio of terminal lobe	gram	gram
length ratio of terminal lobe to rosette leaf	(col)-gram	col-(gram)

In fertilized plots most characteristics of plants of the final populations tend to *S. gramuntia*. Three characteristics are intermediate between *S. columbaria* and *S. gramuntia*, three are similar to *S. gramuntia* and three are even more extreme (gram+) than in *S. gramuntia*. In unfertilized plots the characteristics of the final populations approach *S. columbaria* somewhat more: two are similar to *S. columbaria*, three are intermediate between *S. columbaria* and *S. gramuntia* and three are similar to *S. gramuntia*; only one is more extreme than *S. gramuntia*.

4.3.3. Ground water table (Table 11)

There is not much difference between the morphological characteristics of the plants of the final populations in plots with different water levels. Generally the characteristics are intermediate between *S. columbaria* and *S. gramuntia*.

4.3.4. Watering intervals (Table 12)

The characteristics of the final populations are mostly intermediate between *S. columbaria* and *S. gramuntia*. Some characteristics are even more extreme than in *S. gramuntia*. Under dry conditions (28 day intervals) they show a more pro-

nounced tendency to evolve characteristics of *S. gramuntia* compared with the less dry conditions.

Table 11. Morphological characteristics of the plants of the final populations of *Scabiosa* under differing water table levels compared with *S. columbaria* and *S. gramuntia*.
Morphologische Eigenschaften von Pflanzen der Endpopulationen von Scabiosa unter verschiedenen Bodenwasserständen, verglichen mit S. columbaria und S. gramuntia.

col = *S. columbaria* col-gram = between *S. columbaria* and *S. gramuntia*
gram = *S. gramuntia* gram + = more extreme than *S. gramuntia*

Characteristics	Conditions	
	high water table	low water table
hair density	col	col
length of calyx setae	gram	gram
width of calyx setae	col	gram
stalk length of flower heads	gram+	gram+
stem length	gram	col-gram
length of rosette leaves	col	col
length of terminal lobe	col-gram	col-gram
length/width ratio of terminal lobe	col-gram	col-gram
length ratio of terminal lobe to rosette leaf	col-gram	col-gram

Table 12. Morphological characteristics of plants of the final populations of *Scabiosa* under different watering intervals compared with *S. columbaria* and *S. gramuntia*.
Morphologische Eigenschaften von Pflanzen der Endpopulationen von Scabiosa unter verschiedenen Bewässerungsintervallen, verglichen mit S. columbaria und S. gramuntia.

col = *S. columbaria* col-gram = between *S. columbaria* and *S. gramuntia*
gram = *S. gramuntia* gram + = more extreme than *S. gramuntia*

Characteristics	Watering intervals	
	7 days	28 days
hair density	col-(gram)	col-gram
length of calyx setae	col-gram	gram
width of calyx setae	gram+	gram+
stalk length of flower heads	gram+	gram+
stem length	col-gram	gram
length of rosette leaves	col	gram
length of terminal lobe	col	col
length/width ratio of terminal lobe	col-(gram)	col-(gram)
length ratio of terminal lobe to rosette leaf	col-gram	gram+

4.4. A synthetical approach to the experimental differentiation by discriminant analysis

The layout of greenhouse experiments allowed the formation of ten groups within each condition, i.e. three original species in 1968, the tree descendants of these species within the same containers in 1985 and the descendants of the four combinations of the species originally planted in the same container under cool and warm conditions respectively (Figs. 41 and 42). These ten groups lead to 9 discriminant axis. All the descendants of the pure species and of the mixed populations have developed in the same direction and cannot be distinguished from

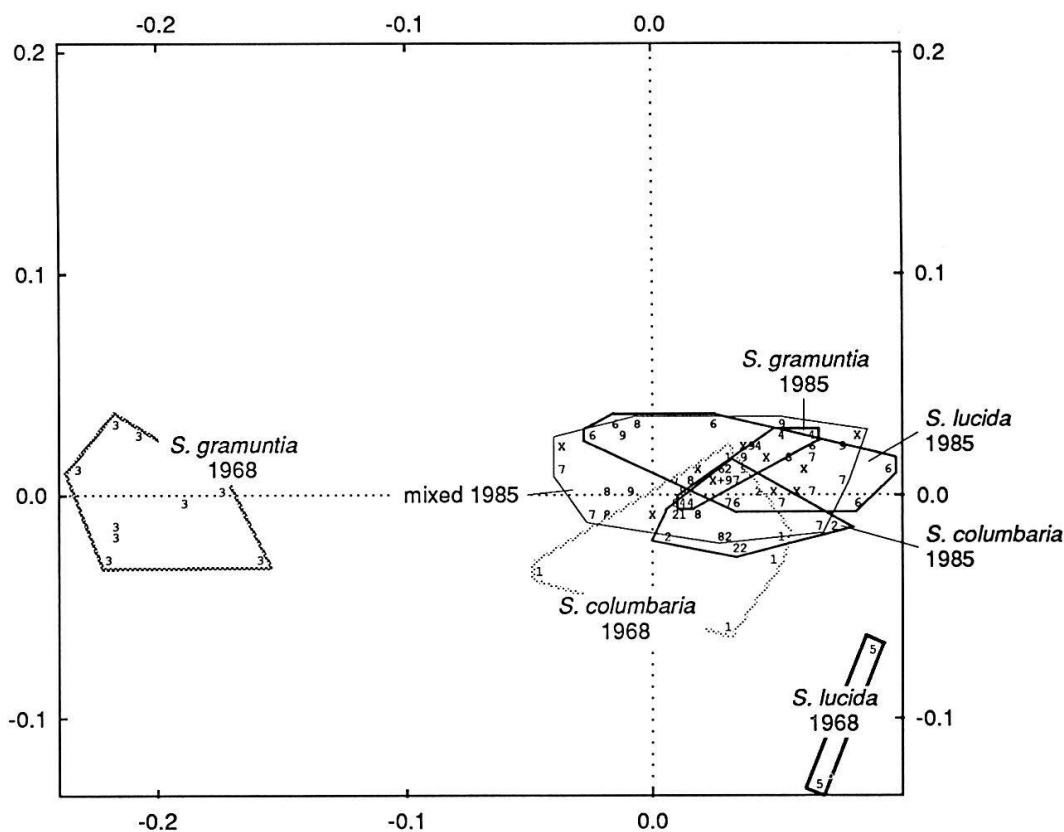

Fig. 41. Discriminant analysis of *Scabiosa* populations under cool conditions in the greenhouse, based on the nine characteristics listed in Chap. 2.3, first and second axis.
Diskriminanzanalyse aufgrund der neun Merkmale nach Kap. 2.3 von Scabiosa-Populationen unter kühlen Bedingungen im Gewächshaus, 1. und 2. Achse.

- | | |
|-------------------------------|------------------------------------------------------------------------|
| 1 = <i>S. columbaria</i> 1968 | 6 = <i>S. lucida</i> 1985 |
| 2 = <i>S. columbaria</i> 1985 | 7 = <i>S. columbaria</i> / <i>S. gramuntia</i> 1985 |
| 3 = <i>S. gramuntia</i> 1968 | 8 = <i>S. lucida</i> / <i>S. columbaria</i> 1985 |
| 4 = <i>S. gramuntia</i> 1985 | 9 = <i>S. lucida</i> / <i>S. gramuntia</i> 1985 |
| 5 = <i>S. lucida</i> 1968 | X = <i>S. lucida</i> / <i>S. columbaria</i> / <i>S. gramuntia</i> 1985 |

each other anymore. Therefore, the areas of the four groups of the mixed populations in 1985 are not marked separately in the figures, only one line surrounding all individuals of the mixed population has been drawn.

Under cool conditions (Fig. 41), the first two axes express almost 75% of the total variance. The group structure, therefore seems to be well represented by these two axes. However, *S. gramuntia* in 1968 being very different from all other groups, has the most extreme values on the first axis. For the same reason, this axis expresses 66% of the between-group variance, the second axis only 17%. The three original species are clearly separated. It should be noted that *S. lucida* is represented only by two individuals, the other eight individuals not having

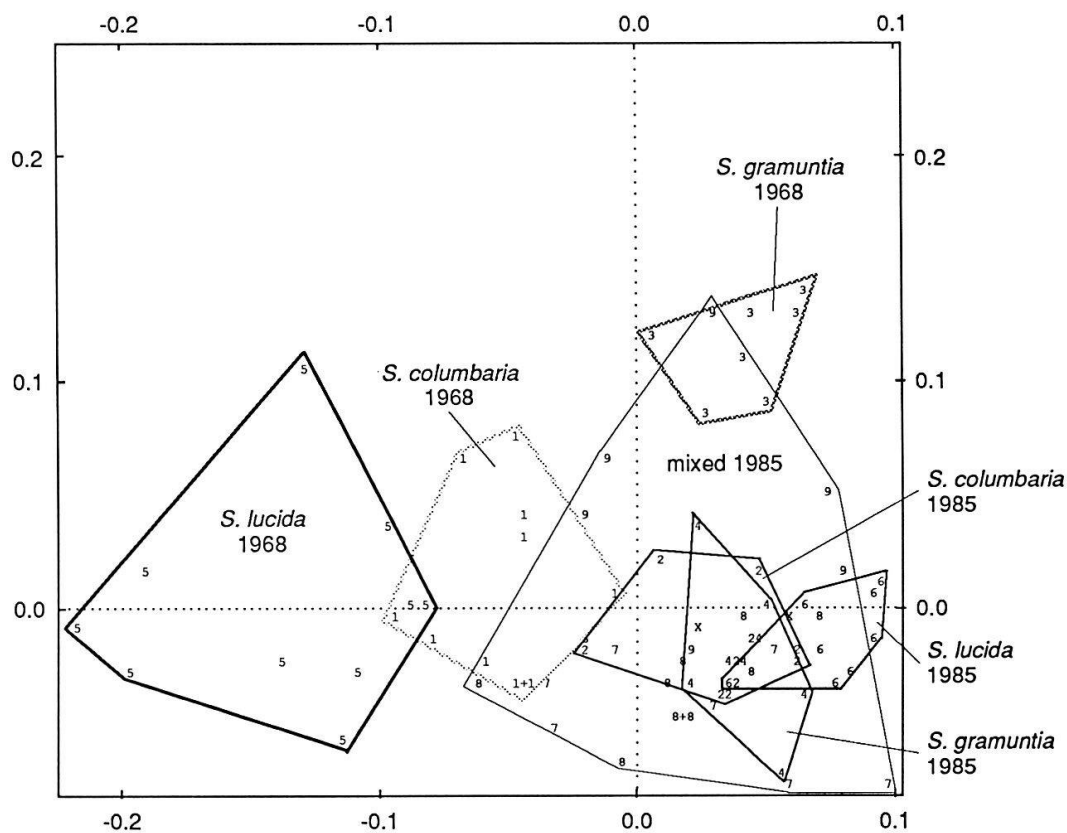

Fig. 42. Discriminant analysis of *Scabiosa* populations under warm conditions in the greenhouse, based on the nine characteristics listed in Chap. 2.3, first and second axis.
Diskriminanzanalyse aufgrund der neun Merkmale nach Kap. 2.3 von Scabiosa-Populationen unter warmen Bedingungen im Gewächshaus, 1. und 2. Achse.

- | | |
|-------------------------------|------------------------------------------------------------------------|
| 1 = <i>S. columbaria</i> 1968 | 6 = <i>S. lucida</i> 1985 |
| 2 = <i>S. columbaria</i> 1985 | 7 = <i>S. columbaria</i> / <i>S. gramuntia</i> 1985 |
| 3 = <i>S. gramuntia</i> 1968 | 8 = <i>S. lucida</i> / <i>S. columbaria</i> 1985 |
| 4 = <i>S. gramuntia</i> 1985 | 9 = <i>S. lucida</i> / <i>S. gramuntia</i> 1985 |
| 5 = <i>S. lucida</i> 1968 | X = <i>S. lucida</i> / <i>S. columbaria</i> / <i>S. gramuntia</i> 1985 |

reached flowering stage in 1968. The populations of the descendants of pure species and of the mixed populations form a very compact pool in 1985. On the first axis, all populations in 1985 lie within the range of *S. columbaria* and *S. lucida* of 1968 whereas on the second axis the range of the final populations is almost identical to the range of *S. gramuntia* in 1968. What characteristics are mainly represented by the first two axes? The negative values on the first axis are mainly due to the hair density of the rosette leaves ($\cos\alpha = -0.51$) and the length of the upper rosette leaves ($\cos\alpha = -0.42$). The minus sign only indicates the sense of direction of the axis, meaning that high attribute values correspond to negative scores. Positive correlations exist between the second axis and the length of the terminal lobe of the upper rosette leaves ($\cos\alpha = 0.44$) and the length of the terminal lobe of the uppermost cauline leaves ($\cos\alpha = 0.42$), respectively.

Under warm conditions (Fig. 42), the first two axes express almost 70% of the total between-group variance (52% and 29%, respectively). Because there is no outlying group similar to *S. gramuntia* under cool conditions (Fig. 41), the group structure of the individuals under warm conditions is more regular and thus well represented by the first two discriminant axes plotted in Fig. 42. The three original species are almost completely separated by the first axis. *S. lucida* and *S. columbaria* differ less from each other than from *S. gramuntia*, a fact which is accentuated by the second axis, separating *S. gramuntia* from the two other species even more distinctly than the first. In 1985, the populations of the descendants of pure species are clearly separated from the original populations but considerably overlap each other. It is noticeable that the descendants of *S. lucida* have moved almost to the opposite position compared with 1968. *S. columbaria* has changed least. Regarding the first axis, the three final populations are quite similar to *S. gramuntia*, on the second axis the values cover almost the same range as *S. lucida* and *S. columbaria*, the variability being somewhat reduced. The individuals of the descendants of the mixed populations cover a wider area than the descendants of the pure species in 1985, the range is enlarged in the directions of *S. columbaria* and *S. gramuntia* 1968. Considering the relations between the discriminant axes and the characteristics, we note the strongest correlation between the width of calix setae and the first axis ($\cos\alpha = -0.80$) followed by the length of calix setae with $\cos\alpha = -0.37$. Positively correlated with the first axis is also the length of the terminal lobe of the uppermost cauline leaves ($\cos\alpha = 0.35$). The second axis is most correlated with the length of the upper rosette leaves ($\cos\alpha = 0.67$) and much weaker with the hair density of rosette leaves ($\cos\alpha = 0.33$). It is negatively correlated with the length of the terminal lobe of the uppermost cau-

line leaves ($\cos\alpha = -0.44$) and with the length of the terminal lobe of the upper rosette leaves ($\cos\alpha = -0.34$).

From the *Scabiosa* populations in the garden, only one example is chosen (low water table level, well fertilized, natural watering conditions). The scattergram (Fig. 43) of the first two discriminant axes shows three clearly distinct groups: the two original species of 1968 and the final population measured in 1983. Because there are only three groups all variance between the groups is expressed by the first two axes (57% and 43% resp.). On the first axis, the final population is totally different from either species of 1968 whereas the values of the final population on the second axis are almost the same as for *S. gramuntia*. The height of the stem has the highest discriminant coefficients to both of the axes, 0.66 and -0.67 . We

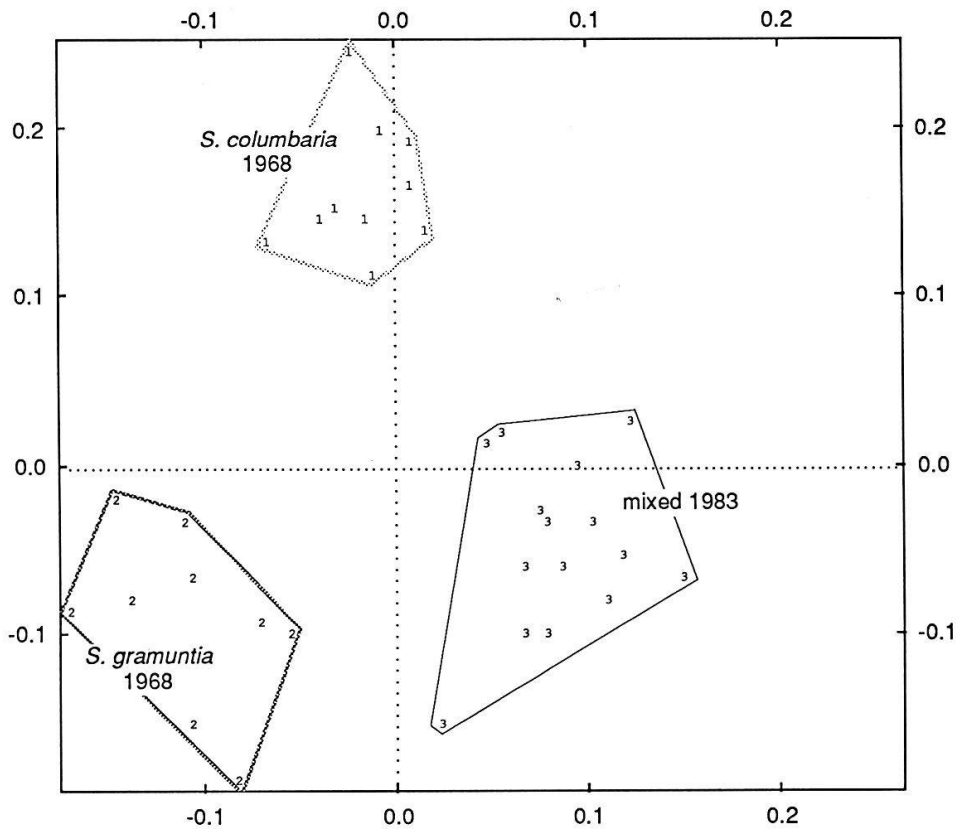

Fig. 43. Discriminant analysis of *Scabiosa* populations in ground water plots with a water level at 145 cm below the ground and well fertilized, based on the nine characteristics listed in Chap. 2.3, first and second axis.

Diskriminanzanalyse aufgrund der neun Merkmale nach Kap. 2.3 von Scabiosa-Populationen in Grundwasserbecken mit einem Grundwasserstand von 145 cm unter Flur und stark gedüngt, 1. und 2. Achse.

1 = *S. columbaria* 1968, 2 = *S. gramuntia* 1968, 3 = *S. columbaria* / *S. gramuntia* 1983

can therefore imagine both discriminant axes standing at an angle of a little more than 45° to the stem height coordinate. The second most important attribute for axis 1 is the hair density ($\cos\alpha = -0.54$), the third is the length of the calyx setae ($\cos\alpha = -0.37$). The second axis, separating *S. columbaria* from the two other groups is furthermore determined by the width of calyx setae ($\cos\alpha = 0.46$), the hair density ($\cos\alpha = -0.35$) and the length of terminal lobe of the upper rosette leaves ($\cos\alpha = 0.33$).

5. DISCUSSION

The aim of the present study was to find out if it is possible to develop different ecotypes from a given genetical pool consisting of three (and two, respectively) species under different environmental conditions. Four factors have been varied in adjacent plots: temperature, nutrient content, water table and watering intervals. Temperature was studied separately in conditioned greenhouse chambers with the other factors left identical. Water table and nutrient content as well as water table and watering intervals were varied in different combinations in the garden. One of the first questions which arises is: How long does it take to get stable populations which are adapted to the new given conditions? Or with other words: Is the study period of 15 years long enough to reach the final stage of selected combinations of characteristics in each population under the different conditions? Only if a certain stability is reached, can a statement on the possible development of new ecotypes under different conditions be made.

5.1. Stability of the characteristics of the final populations

Taking into account, that the average life-time of an individual *Scabiosa* plant is between three and five years, we can suppose that most of the plants at the end of the study period represent the third or the fourth generation. This is obviously a very low number if the selection pressure is not high. However, at least the hair density and calyx setae of the descendants of the original three (resp. two) species developed under most conditions to an average which was in 1985 (resp. 1983) for all plants not very different for a single species from that in 1979. The other characteristics showed more variation within this time-span. In addition, some differences occurred between the plots of different descendants. However, these differences are not statistically significant. The more variable characteristics also showed a more pronounced phenological plasticity and already varied to a great