

Zeitschrift: IABSE congress report = Rapport du congrès AIPC = IVBH
Kongressbericht

Band: 14 (1992)

Artikel: Earthquake hazard mitigation in new and existing structures

Autor: Seible, Frieder / Priestley, M.J. Nigel

DOI: <https://doi.org/10.5169/seals-853252>

Nutzungsbedingungen

Die ETH-Bibliothek ist die Anbieterin der digitalisierten Zeitschriften. Sie besitzt keine Urheberrechte an den Zeitschriften und ist nicht verantwortlich für deren Inhalte. Die Rechte liegen in der Regel bei den Herausgebern beziehungsweise den externen Rechteinhabern. [Siehe Rechtliche Hinweise.](#)

Conditions d'utilisation

L'ETH Library est le fournisseur des revues numérisées. Elle ne détient aucun droit d'auteur sur les revues et n'est pas responsable de leur contenu. En règle générale, les droits sont détenus par les éditeurs ou les détenteurs de droits externes. [Voir Informations légales.](#)

Terms of use

The ETH Library is the provider of the digitised journals. It does not own any copyrights to the journals and is not responsible for their content. The rights usually lie with the publishers or the external rights holders. [See Legal notice.](#)

Download PDF: 08.02.2025

ETH-Bibliothek Zürich, E-Periodica, <https://www.e-periodica.ch>

Earthquake Hazard Mitigation in New and Existing Structures

Réduction du danger dans les structures exposées aux séismes

Reduzierte Erdbebengefahr bei neuen und alten Tragwerken

Frieder SEIBLE

Prof. of Struct. Eng.
Univ. of California,
San Diego La Jolla, CA, USA

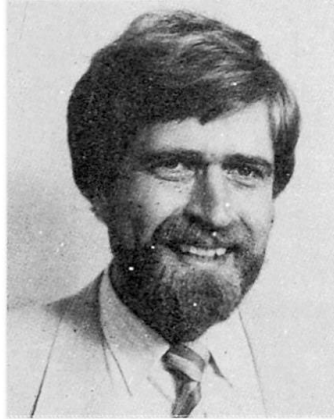

Frieder Seible has been a member of the UCSD faculty for 8 years. He has Civil Engineering Degrees from Germany, Canada and the USA and he is a member of the Seismic Advisory Board for Caltrans. His research interests combine large scale experimental testing and nonlinear analytical modelling of structural concrete systems.

M.J. Nigel PRIESTLEY

Prof. of Struct. Eng.
Univ. of California,
San Diego La Jolla, CA, USA

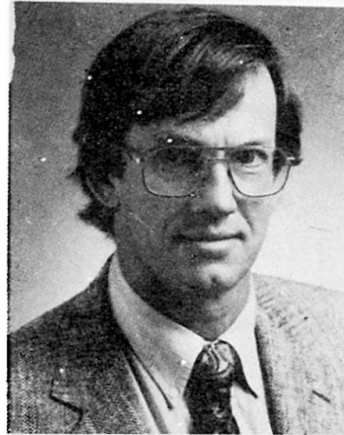

M.J. Nigel Priestley has received numerous international awards (ACI, PCI) for his earthquake engineering and structural concrete and research contributions. He has been a member of the faculty of the University of Canterbury, Christchurch, New Zealand for eleven years prior to joining UCSD.

SUMMARY

The unpredictable and devastating nature of earthquakes and the socio-economic consequences resulting from the failure of man-made structures emphasize the responsibility of the civil engineering profession with every major seismic event. Failures of civil structural systems in past earthquakes have shown that structural earthquake hazards exist around the world independent of the level of technical, cultural, social or economic development, and that earthquake hazard mitigation is a problem which needs to be addressed globally. Fundamental steps towards a rational and comprehensive structural systems design approach for earthquake hazard mitigation are outlined.

RÉSUMÉ

La nature imprévisible et dévastatrice des tremblements de terre et les conséquences socio-économiques résultant de la défaillance de structures anciennes et nouvelles mettent en relief la responsabilité des ingénieurs civils, chaque fois que se produit un séisme. Les ruptures de systèmes structuraux des bâtiments, survenues au cours de tremblements de terre récents et anciens, ont montré que les dangers dus aux séismes et encourus par les structures existent partout dans le monde, indépendamment du niveau de développement technique, culturel, social ou économique. De plus, la réduction du danger des tremblements de terre est un problème qu'il faut aborder globalement. Cet article esquisse les étapes fondamentales à effectuer vers une méthode rationnelle et globale de calcul des systèmes structuraux dans la réduction du danger aux séismes.

ZUSAMMENFASSUNG

Die Unvorhersagbarkeit und Zerstörungskraft von Erdbeben sowie die sozio-ökonomischen Folgen des Versagens von Menschen errichteter Bauwerke führen mit jedem Erdbeben die Verantwortung des Bauingenieurberufs neu vor Augen. Die Versagensfälle der Vergangenheit haben gezeigt, dass die bauliche Gefährdung weltweit ohne Ansehen des technischen, kulturellen, sozialen oder wirtschaftlichen Entwicklungsstands existiert und entsprechend angegangen werden muss. Der Beitrag umreißt die fundamentalen Schritte zu einem rationalen und umfassenden Entwurfskonzept für Tragwerke mit reduzierter Anfälligkeit auf Erdbeben.



1. INTRODUCTION

Earthquakes around the world have repeatedly demonstrated, and will continue to demonstrate, the vulnerability of man-made structural systems to seismic input. Major earthquakes in recent years such as Mexico 1985, Armenia 1988, Loma Prieta (San Francisco) 1989, Philippines 1990 and Costa Rica 1991 have shown, with their devastating consequences in terms of loss of life, loss and interruption of regional infrastructure and damage to public and private property, that a global need for structural earthquake hazard mitigation exists independent of technical, cultural, social or economic development levels.

The civil and structural engineering challenge and obligation to mitigate seismic structural hazards has to concentrate on two major areas, namely (1) the design of new structural systems and (2) the assessment and retrofit of existing structures to withstand probable earthquakes within defined performance criteria. For new structural design in seismic zones, deformation based performance limit states have to replace force driven conventional design criteria, and performance specifications for individual structures have to reflect not only structural properties but, equally importantly, consequences of partial or complete failure if a meaningful earthquake hazard mitigation is to be achieved. The seismic rehabilitation of existing structural systems has to be based on the latest research findings due to the just recently evolving nature of retrofitting knowledge and basic retrofitting technology, preceded by a realistic seismic performance assessment of the as-built and the retrofitted structures. Both new seismic design and seismic retrofit have to evaluate structural systems and component behavior differently from conventional gravity and live load design principles which are mostly force driven and based on lower bound strength principles. Since the unpredictable earthquake load case typically develops and exceeds the inherent strength of a structural system, seismic design must ensure that (1) the structure can perform inelastically through the formation of defined mechanisms, (2) the mechanisms are of a ductile nature which ensures large inelastic deformations and energy absorption without significant loss of capacity and (3) the safety margin to other non-ductile or brittle mechanisms forming in individual components is clearly established. Only if these deformation and capacity criteria are clearly established and adhered to, can the structure be expected to survive an earthquake which exceeds the structural elastic capacity.

In the following, ideas and principles are summarized which form the basis for a rational comprehensive seismic design approach, and evolving procedures are outlined for the increasingly important seismic retrofit of existing and aging structural systems. Even though the principles presented are equally applicable to building, bridge and lifeline structures, the examples will concentrate on bridge structures damaged during the 1989 Loma Prieta earthquake due to the extensive nature of available as-built structural and research data. A general overview is provided on seismic structural problems followed by a discussion of their mitigation through new design and relevant assessment and retrofit measures for existing structural systems based on the latest research data.

2. SEISMIC STRUCTURAL PROBLEMS

Earthquakes show their devastating nature through damaged and collapsed man-made structural systems which in turn are responsible for loss of life, damage to regional infrastructure, and interruption of associated essential services. The three categories of structures supporting our socioeconomic systems are buildings, bridges and lifelines, and all three are equally affected by major seismic events.

The partial or complete collapse of buildings is typically a major source of earthquake related casualties, and can be attributed to various problem areas ranging from conceptual systems selection and design to the construction, usage and maintenance. Major earthquakes in China and Armenia with heavy building failures suggest problems with the selected structural system, i.e. unreinforced masonry or the structural systems connection detailing of prefabricated reinforced concrete buildings, respectively. Additional system problems frequently encountered in seismic building failures are pounding effects of adjacent structures, soft stories, irregular

geometry with significant stiffness changes in the horizontal and vertical directions, and inadequate footing performance. However, to label certain building systems as inherently unsafe has been proven wrong by the performance of similar systems in other earthquakes and by in-depth structural systems research. It is not an inherent fault with the selected structural system but rather an inadequate understanding of seismic input, seismic structural systems response and appropriate mitigating design principles.

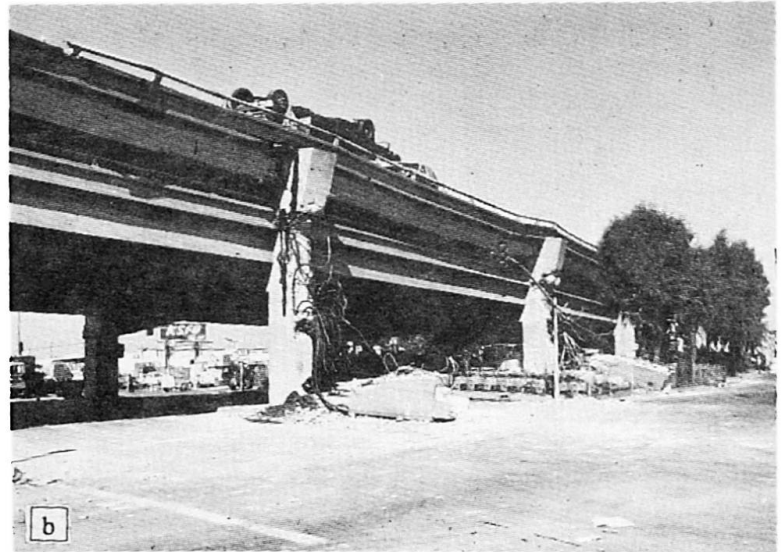
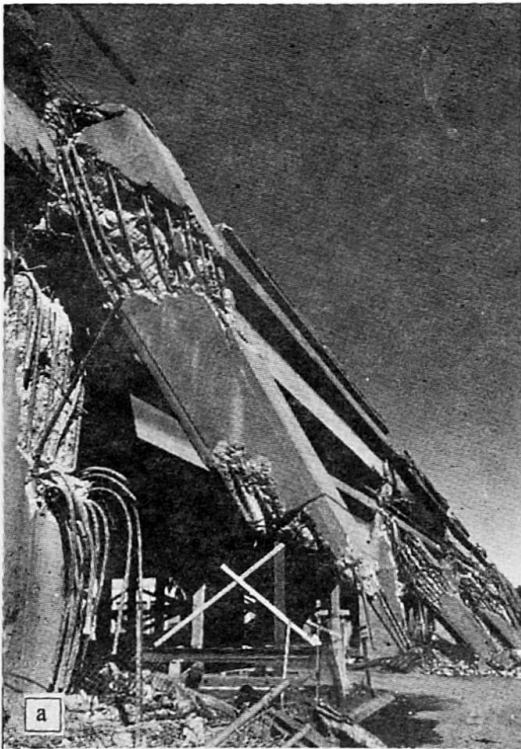

I-880
Oakland, CA
October 1989

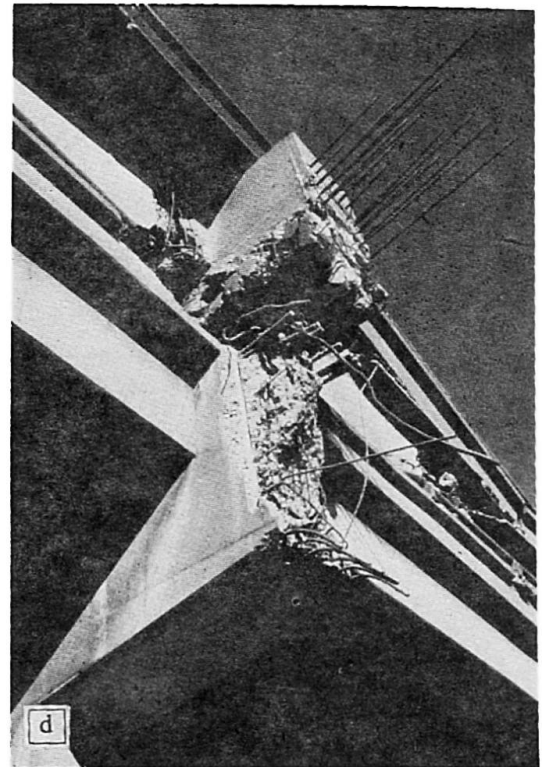

FIG 1. Bridge Damage During the 1989 Loma Prieta Earthquake

Bridge damage and/or collapse is noticed mostly due to its impact on traffic circulation patterns following a major earthquake. Quite often, it is the bridges most needed for post-earthquake search and rescue and relief operations which are collapsed or have to be closed. The duration of closure directly impacts the economic post-earthquake recovery of the affected region. Again, while many seismic bridge problems (see Fig. 1) can be associated with the choice of the structural system, the earthquake hazard also could have been mitigated by appropriate design



and detailing measures. [1]. Primary seismic problems in bridge structures include foundation and footing problems (e.g. liquefaction), expansion joint and seating problems due to lack of seat width and/or force constraint across the joint, inadequate member capacities in flexure and/or shear, lack of redundancy in the structural system to allow alternate load paths, and the detailing of joints between primary structural members such as footing/column connections, column/cap beam and cap beam/superstructure connections.

Loss of lifelines can be devastating both immediately during the seismic event, i.e. rupture of water reservoirs and dams, or following the earthquake in the form of fire danger from ruptured gas lines, disrupted water supplies to extinguish fires and epidemic sanitary and health problems from interrupted fresh and waste water systems.

Since the forces resulting from an earthquake in our manmade structural systems are unpredictable due to the unknown time, duration, epicentral location, magnitude, and dynamic characteristics, it is virtually impossible to design for these forces in a deterministic manner. Also, to design for the probable or most credible force levels elastically to prevent seismic structural damage is in most cases technically difficult and economically and aesthetically prohibitive. Thus, mitigation efforts have to assume that the structure will be loaded beyond the inherent force capacity and that inelastic action and damage will occur. However, this inelastic action can be controlled to occur in a ductile mode with known mechanisms at predetermined locations which still allow the system to deform and dissipate seismic energy without losing its critical function of sustaining gravity loads [2]. As part of a comprehensive seismic hazard mitigation design approach, not only the performance of the structural system but also the hazard in the form of ground motion and soil conditions and the consequences of structural failure in the form of potential loss of life and economic impact have to be evaluated in assessing the seismic risk of our manmade structures. In the following, some of these principles are outlined using bridge design examples, both for new designs and retrofit of existing structures.

3. SEISMIC EARTHQUAKE HAZARD MITIGATION

A comprehensive seismic structural hazard design approach should include the components of (1) Risk Assessment, (2) Equivalent Seismic Load Input, (3) Component Assessment and/or Design (4) Systems Evaluation, (5) Final Design or Retrofit. These components are schematically outlined in Fig. 2.

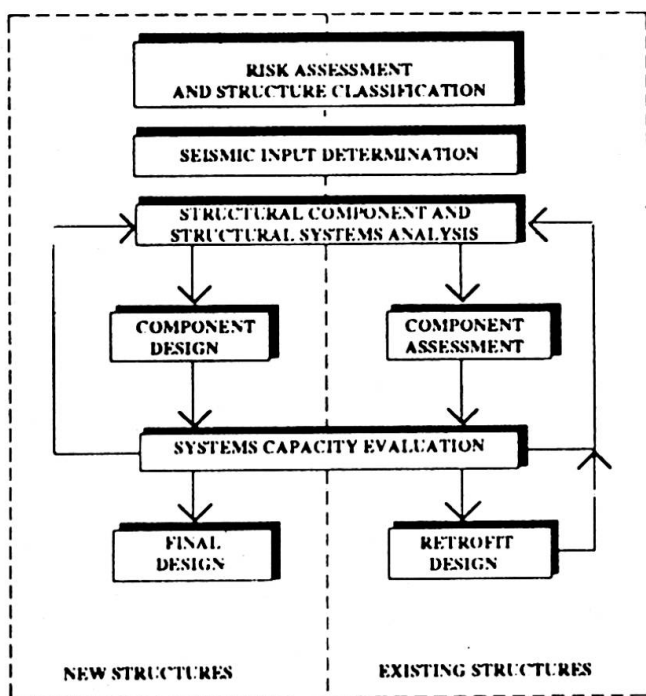

FIG 2. Seismic Design Process

The seismic risk assessment for a structure should involve the three principal components of hazard, structure and consequence. The hazard component reflects the probabilistic seismic input in terms of magnitude, probability of occurrence and soil/geological characteristics of the most probable seismic ground excitation. The structure component should address structural performance characteristics in terms of redundancy, detailing for inelastic action and critical geometry. Finally, the consequence component should address the importance of the structure and provide input on potential for loss of life consequences of failure or closure of the structure under evaluation. These three categories can be combined in a cumulative or multiplicative weighted risk algorithm to determine an estimate of the seismic risk for the structure. As an example of a risk assessment algorithm Fig. 3 shows the component and category tree structure currently used by

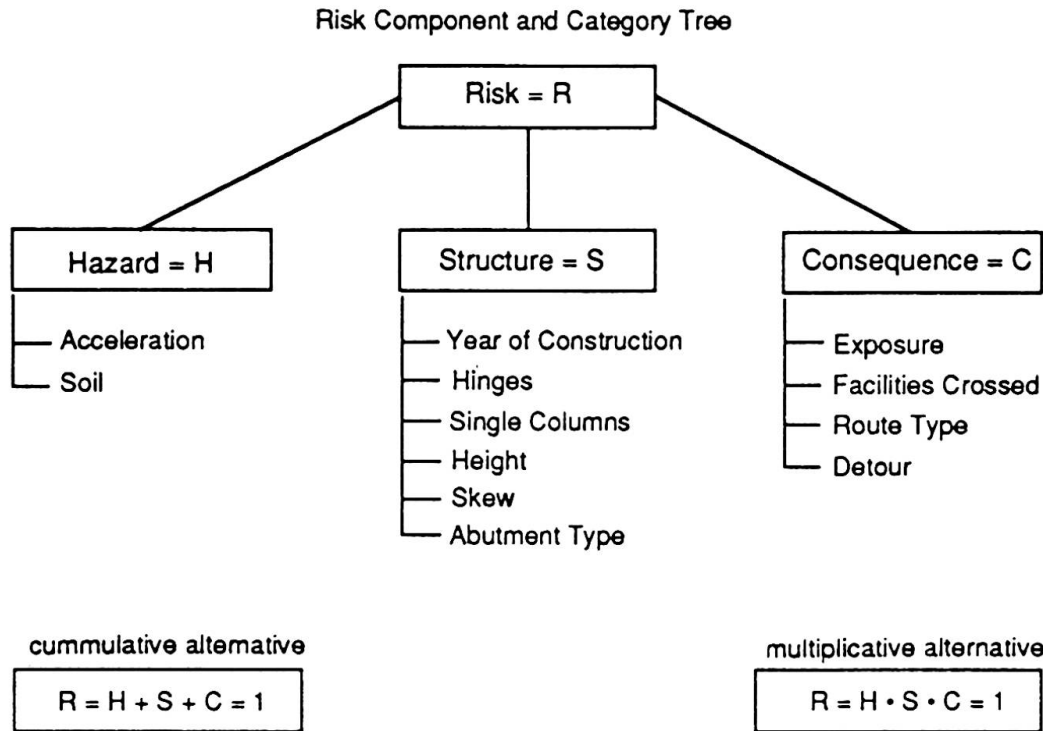

FIG 3. Seismic Risk Assessment Algorithm

California Department of Transportation (Caltrans) to assess the seismic retrofit priorities of over 24,000 bridge structures in California [3]. This risk evaluation can now be used to determine critical design limit states for the structural system and guidelines on how these design limit states should be achieved.

In the design phase of new structures or retrofits, design limit states should address the expected performance level and state of the structure during and after the earthquake, and should be directly tied to the structural importance and risk priority derived above. The essential seismic design limit state for any structural system is the collapse limit state defined as the state of structure at which gravity loads can no longer be supported. All structural systems should be designed to avoid this limit state but depending on the importance or risk level additional, more stringent design limit states should be added. A damage control limit state which prevents collapse but allows repairable damage of various degrees to occur could be formulated based on the importance of the structure and the consequences of a prolonged shutdown. Finally, essential facilities or structures servicing or leading to them should be designed based on serviceability limit states which would allow limited inelastic action resulting in minor damage and in uninterrupted and continued safe operation of the structure. One way to meet descriptive design limit states performance criteria as outlined above is to limit the inelastic structural response of the system since increased inelastic response is directly tied to increased damage levels. For example, inelastic structural response can be quantified by displacement ductility levels of the complete system, as sketched out on Fig. 4, where an idealized bilinear elasto-plastic approximation of the actual load-deformation relationship of the center of mass of the system defines the yield displacement level $\mu = 1$ (at $\Delta = \Delta_y$) and subsequent damage or ductility levels μ ($\Delta = \mu\Delta_y$) as multiples of the yield displacement. For long period structures, the equivalent elastic deformations are approximately equal to the actual (inelastic) deformations which allows a reduction of the equivalent elastic forces to the idealized plastic capacity level, i.e. the elastic force reduction factor $R = \mu$. For shorter period structures an "equal energy" approach can be used to define the relationship between R and μ .



The derived elastic force reduction can now be used to establish an appropriate deterministic load input for the structural system in the form of acceleration response spectra which determine equivalent static seismic loads on the system.

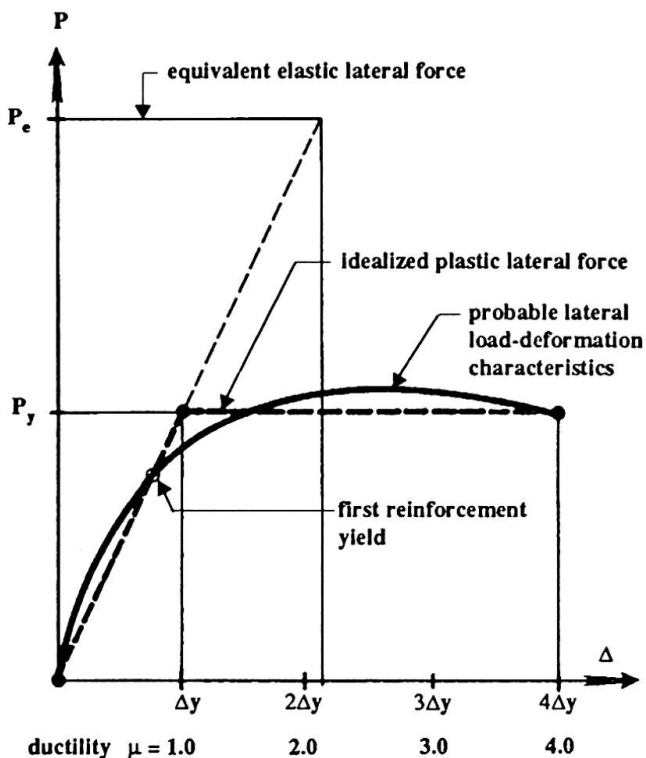

FIG 4. Load Deflection Behavior and Equivalent Elastic Forces

The actual member design for new structures and the assessment of actual member capacities for existing structures requires an evaluation of the most probable capacities of the component, i.e. a best estimate of the actual strength and deformation characteristics. Since in an inelastic design the earthquake will mobilize the inherent strength, a key design consideration has to be the formation of ductile mechanisms (not brittle shear or anchorage failures) which allow the structure to deform inelastically without significant loss of capacity. This design approach requires realistic capacity checks and comparisons of local mechanisms within each element and of adjacent joints, connections and members to ensure a global ductile systems mechanism. This capacity design concept was introduced by Park and Paulay [2] and finds increasing acceptance as one of the most powerful design tools in earthquake hazard mitigation. The same capacity based approach can also be applied to assess the seismic vulnerability of existing structures and to design, if necessary, appropriate retrofit concepts.

Based on this outlined design philosophy, new or existing structural systems can be designed, assessed, and or retrofitted, to allow various levels of inelastic deformation and damage as defined by the specified performance design limit states. An example of this capacity based approach is provided in the following example of a bridge assessment for one of the bridge structures damaged during the 1989 Loma Prieta earthquake.

4. ASSESSMENT OF EXISTING STRUCTURES

The key component in a comprehensive capacity based seismic design approach is the correct assessment of the component and systems behavior under combined gravity and seismic loads. Some of the principles involved in this assessment phase are outlined below in the examples of outrigger bents severely damaged during the 1989 Loma Prieta earthquake.

The realistic assessment of the component capacities and critical mechanisms of an existing bridge structure is based on the following steps:

1. Determine the most probable material properties; For existing concrete structures the actual concrete strength has significantly increased with time over the nominal design strength f'_c and reinforcement typically features higher yield than the specified nominal grade. Unless material tests on the existing structure are performed, assumptions of a 50% increase in concrete strength and a 10% increase in reinforcement yield strength are reasonable, i.e. $f'_c = 1.5 f'_{c,design}$ and $f_y = 1.1 f_{y,design}$.

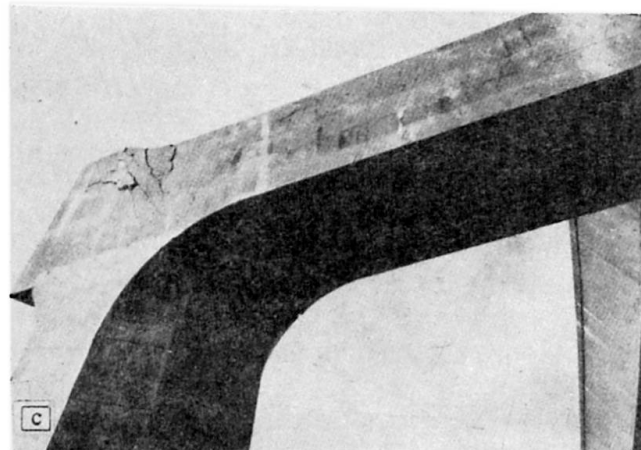
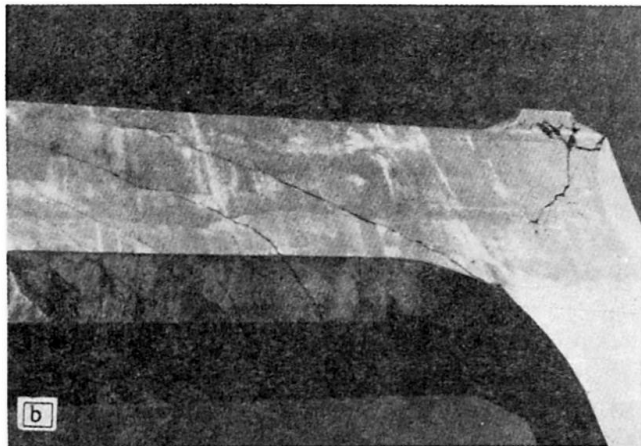
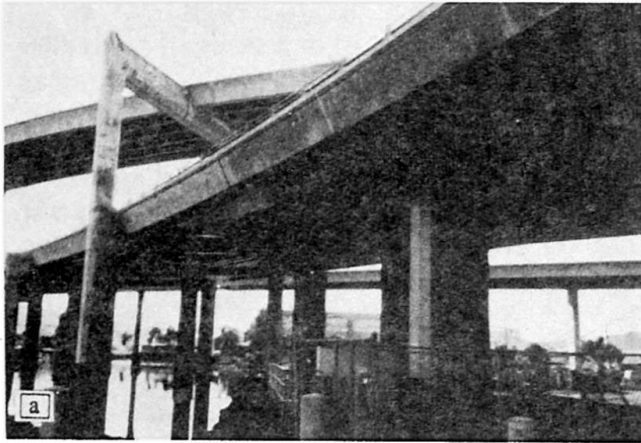

FIG 5. Earthquake Damage, Loma Prieta 89, China Basin Viaduct

2. Flexural capacities for the individual beam and column members are determined using above material properties and section analysis techniques which are based on a realistic concrete stress-strain relationship including axial load, confinement effects, and strain hardening. Flexural member capacities need to be adjusted where inadequate development length of the main reinforcement (see Fig. 1d) or lap splices with insufficient lap length or confinement limit the full capacity development under fully reversed cyclic loads. Detailed guidelines on the proper assessment of reinforcement development were proposed by Priestley [4].
3. The probable member shear capacities are determined, using a model which accounts for degrading concrete contributions with increasing ductility demand, truss action for stirrup reinforcement, and axial load effects from gravity loads or prestress as outlined by Priestley [4].
4. To determine the critical member mechanism, the plastic shear demand V_p of the member is determined based on full flexural plastic hinging and compared with the actual member shear capacity V_n . If $V_n > V_p$ a ductile flexural member failure mechanism can be expected. If $V_p > V_n$ the member might fail in a brittle shear mode prior to reaching its full flexural mechanism.
5. A combined gravity and earthquake (static lateral load) analysis of the complete gravity load support system or bent (beam - column assemblage) is now performed as a stepwise linear elastic event scaling procedure to determine the sequential formation of critical member mechanisms all the way to the critical systems collapse mode.

6. From the final global collapse mechanism, critical lateral load level and corresponding internal forces can now be determined. A check on joint shear in beam-column and column-footing connections and on footing capacities has to be performed with the obtained internal collapse loads based on capacity design principles [2] to ensure that no other degrading or brittle mechanisms develop in connecting or adjacent elements. If these capacity checks show deficiencies in the joints or adjacent members, appropriate systems load and deformation capacity reductions based on the expected level of cyclic degradation, see Priestley [4], have to be made.



7. The derived lateral load and expected deformation capacity for the structural system can now be compared to the required seismic load demand and the associated deformation or ductility design limit state as outlined in Fig. 2 to determine appropriate retrofit measures, as summarized by Priestley and Seible [5].

A general overview of the first outrigger bent on I-280 (China Basin Viaduct, San Francisco) is shown on Fig. 5a and damage patterns encountered during the earthquake are depicted in Figs. 5b and c. The as-built reinforcement details of the bent cap and columns are depicted in Fig. 6 and moment capacities and demands in the cap beam for separate and combined gravity and seismic loading are shown in Fig. 7. Following the outlined procedure, the bridge bent, shown in Figs. 5 to 7, was assessed [1]. Cap beam capacities were found well below corresponding column capacities and were thus critical for the overall seismic assessment. Member shear capacities were found to exceed flexural plastic shears. A unit lateral (seismic) load was applied to the bridge bent model and scaled to levels E_I and E_{II} where combined seismic and gravity loads form sequential mechanisms in the cap beam as shown in Fig. 7.

Lateral response force levels of $\ddot{E} = 0.63 \text{ g}$ and $\ddot{E} = 0.69 \text{ g}$ in the two directions, respectively, were found to cause complete global flexural mechanisms to develop. Particularly under loading to the right, see Figs. 6 and 7, the termination of negative or top reinforcement at a distance of 6.1 m from the column centerline is cause for the onset of a negative moment crack which propagates toward the column in shear aided by the lack of cap beam shear reinforcement in this region, see Fig. 6. A wide flexural-shear crack was observed in this region, as predicted, see Fig. 5c.

Joint shear cracking was calculated for both joints at lateral force levels less than those corresponding to the first flexural hinge formation. Approximate values corresponding to a joint shear stress of $0.33\sqrt{f'_c}$ MPa are $\ddot{E} = 0.45 \text{ g}$; and $\ddot{E} = 0.40 \text{ g}$, respectively. Thus, significant joint shear stress, as seen in Figs. 5b and c, can be expected. While the level of cracking visible in the positive knee joint moment regions of the bent cap beam indicated that the cap did not reach first flexural hinge formation, the shear stresses in the joints were high enough to cause joint failure. Hence the response accelerations appear to have exceeded 0.4 g in each direction. However, since both cap beam and joint mechanisms form at very similar lateral load levels and the distress pattern in the cap beam also reflects the reinforcement inadequacies, no repair or retrofit measure but rather complete replacement of the entire bent was recommended [1].

The second outrigger bent assessment example from the 89 Loma Prieta earthquake was performed for bent #38 on the I-980 southbound connector in Oakland, CA. Reinforcement details and dimensions of the critical knee joint are shown in Fig. 8. Based on capacity checks for both cap beam and columns, as outlined above, and from subsequent sequential failure mechanism analyses [1], the joint shear stress levels in the knee joint at the collapse limit state were found to be in excess of $0.5\sqrt{f'_c}$ and $0.35\sqrt{f'_c}$ [MPa] for closing and opening knee joint moments, respectively. Thus, joint shear damage can be expected prior to the development of any flexural ductile beam or column mechanism as demonstrated by the encountered distress patterns during the Loma Prieta earthquake, depicted in Fig. 9. Since existing beam and column capacities and reinforcement detailing were satisfactory to allow limited ductile performance, repair and retrofitting of the joint was performed by complete removal of the joint concrete, added joint shear reinforcement and an increased joint size.

While the above capacity based assessment examples were performed for existing bridge structures, similar capacity based procedures should also be employed in new structural systems design, see Fig. 2, to ensure ductile structural systems which allow seismic energy dissipation through well defined and appropriately detailed ductile mechanisms.

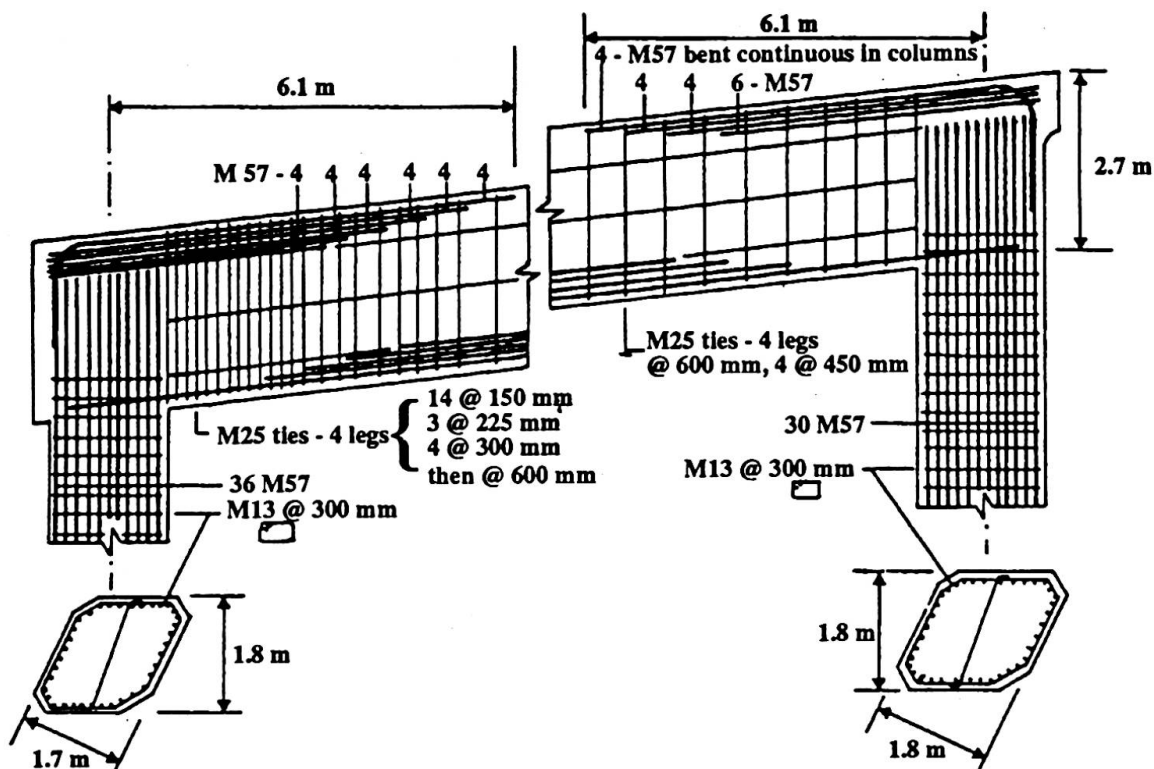

FIG 6. China Basin, Bent N₁-35 Reinforcement

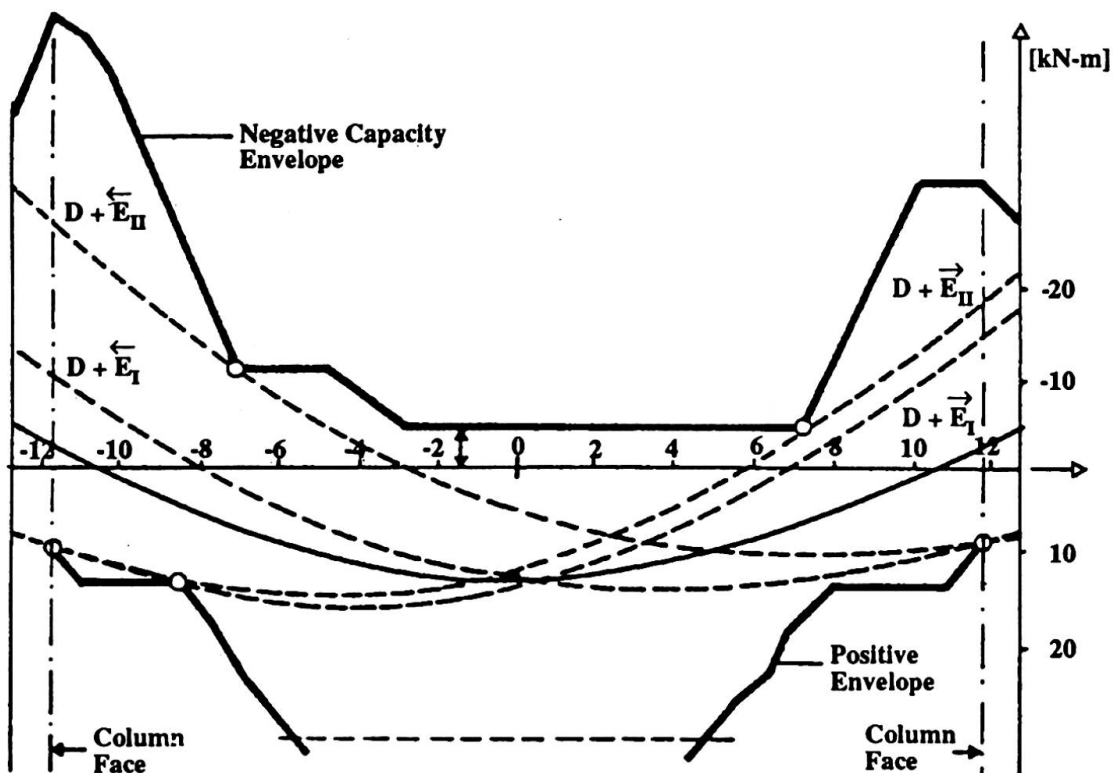

FIG 7. China Basin, Bent N₁-35, Moment Capacities and Demand

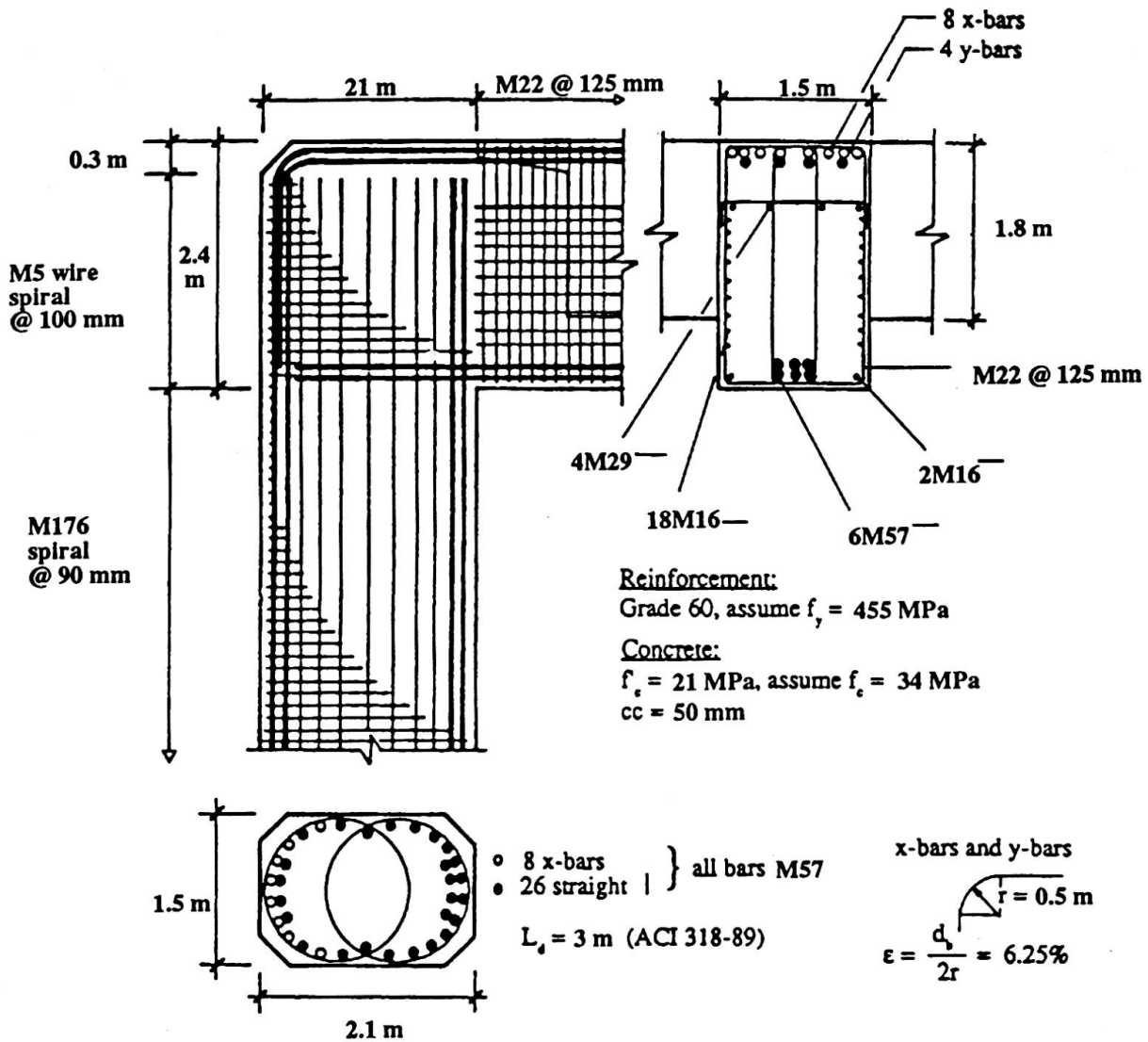

FIG 8. I-980, Bent #38 Reinforcement Details

5. CONCLUSIONS

To mitigate earthquake hazards arising from new or existing structural systems, a comprehensive seismic design and assessment approach is needed which accounts for seismic risk of the structure in terms of importance, consequence of failure, and probability of occurrence of the seismic design event. This seismic risk evaluation needs subsequently to be employed to define expected structural performance levels in the form of descriptive performance design limit states on one hand, and in determining appropriate design guidelines on the other hand. The deterministic portion of the seismic design process should be based on a capacity philosophy where local and global structural failure mechanisms are determined based on realistic or most probable materials and performance characteristics. The goal is to design a retrofit for the development of ductile well confined (flexural) plastic hinge mechanisms which will allow the structure to deform inelastically without significant lateral capacity deterioration. Capacities of adjacent members, connections and joints, have to be designed with sufficient margin to ensure flexural plastic hinge development considering axial load effects, concrete overstrength, confinement effects and actual reinforcement strength including strain hardening. Seismic structural design based on the above principles will allow a comprehensive and rational seismic structural hazard mitigation process.

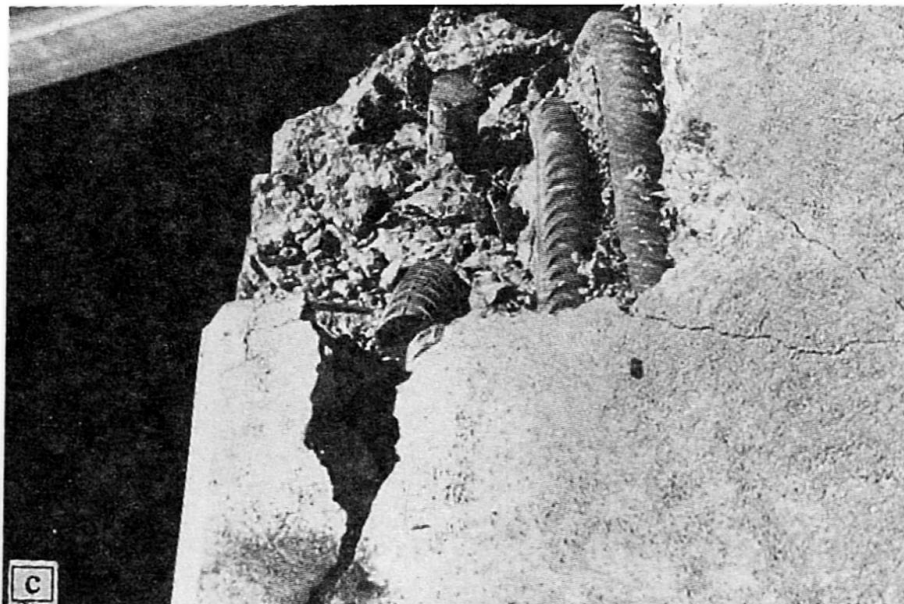
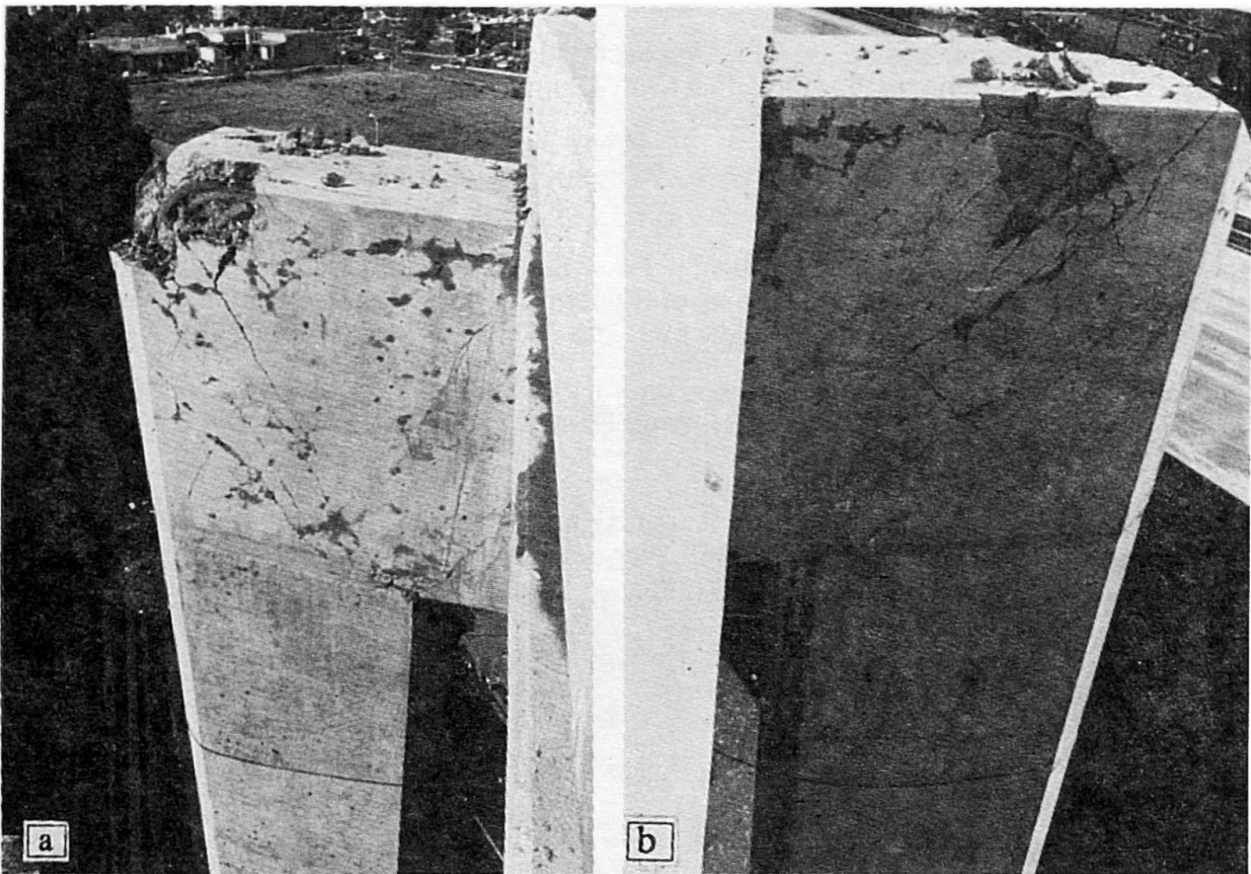

FIG 9. I-980 Oakland, CA, Encountered Damage Patterns



REFERENCES

- [1] PRIESTLEY M.J.N. and SEIBLE F., "Assessment of Bridge Damage During the Loma Prieta Earthquake," University of California, San Diego, Structural Systems Research Project, Report No. SSRP-90/01, March 1990.
- [2] PARK, R. and PAULAY T., "Reinforced Concrete Structures," John Wiley & Sons, New York, 1975, pp. 769.
- [3] MARONEY B. and GATES J., "Seismic Risk Identification and Prioritization in the Caltrans Seismic Retrofit Program," University of California, San Diego, Structural Systems Research Project, Report No. SSRP-91/03. July 1991, pp. 27-54.
- [4] PRIESTLEY M.J.N., "Seismic Assessment of Existing Concrete Bridges," University of California, San Diego, Structural Systems Research Project, Report No. SSRP-91/03, July 1991, pp. 84-149.
- [5] PRIESTLEY M.J.N., and SEIBLE F., "Design of Seismic Retrofit Measures for Concrete Bridges," University of California, San Diego, Structural Systems Research Project, Report No. SSRP-91/03, July 1991, pp. 197-250.