

**Zeitschrift:** IABSE congress report = Rapport du congrès AIPC = IVBH  
Kongressbericht

**Band:** 14 (1992)

**Rubrik:** Special Session 1: Tensioned structures

### **Nutzungsbedingungen**

Die ETH-Bibliothek ist die Anbieterin der digitalisierten Zeitschriften. Sie besitzt keine Urheberrechte an den Zeitschriften und ist nicht verantwortlich für deren Inhalte. Die Rechte liegen in der Regel bei den Herausgebern beziehungsweise den externen Rechteinhabern. [Siehe Rechtliche Hinweise.](#)

### **Conditions d'utilisation**

L'ETH Library est le fournisseur des revues numérisées. Elle ne détient aucun droit d'auteur sur les revues et n'est pas responsable de leur contenu. En règle générale, les droits sont détenus par les éditeurs ou les détenteurs de droits externes. [Voir Informations légales.](#)

### **Terms of use**

The ETH Library is the provider of the digitised journals. It does not own any copyrights to the journals and is not responsible for their content. The rights usually lie with the publishers or the external rights holders. [See Legal notice.](#)

**Download PDF:** 13.02.2025

**ETH-Bibliothek Zürich, E-Periodica, <https://www.e-periodica.ch>**



## **Special Session 1**

### **Tensioned Structures**

### **Structures en tension**

### **Zugbeanspruchte Konstruktionen**

Organizer: Ted Happold.  
UK

Leere Seite  
Blank page  
Page vide

## Tension Structures — A Brief Review

Structures en tension — brève revue

Zugtragwerke — eine Entwicklungsskizze

**Ted Happold**  
Professor  
Buro Happold  
Bath, UK



Ted Happold is a Past President of the Institution of Structural Engineers, Senior Partner of Buro Happold, consulting engineers, and Professor of Building Engineering at the University of Bath.

**Ian LIDDELL**  
Structural Engineer  
Buro Happold  
Bath, UK



Ian Liddell is the second partner of Buro Happold, consulting engineers. In the past fifteen years he has been responsible for a number of cable and fabric structures and other specialist engineering projects carried out by the office.

### SUMMARY

This paper reviews design methods for surface stressed buildings and gives some design examples of the authors' current experience.

### RÉSUMÉ

L'article passe en revue les méthodes de conception des bâtiments à couverture en tension et donne des exemples de conception tirés de projets actuels des auteurs.

### ZUSAMMENFASSUNG

Dieser Beitrag untersucht Konstruktionsverfahren für oberflächenverspannte Gebäude und bietet einige Konstruktionsbeispiele aus den kürzlich gewonnenen Erfahrungen.



## TENSION STRUCTURES - A BRIEF REVIEW

It is important to differentiate between the types of tension structures used in building. Bridge design has certainly influenced building. The concept of the suspension bridge is very old and building engineers such as Nervi, have employed the idea for a long time. Cable-stayed stiff roofs have been a substitution, with cables for the struts of propped cantilevers. The Forth bridge design of Fowler and Baker (Fig 1.1) expressed it clearly nearly one hundred years ago. Morandi copied it in prestressed concrete for his Maracaibo Bridge in 1957 and then developed the idea for his hangar roofs at Fiumicino airport in 1961. The stay cables support the beams along their length while uplift is counteracted by a combination of tie downs at the end, and the deadweight of the roof itself. A similar structural idea was used on the Sainsbury's store for Canterbury (Fig 1.2) in which we assisted Ernest Green and Partners. Indeed, we used a similar system for spanning the Tesco supermarket for Bristol (Fig 1.3).

As in bridge design, cables provide intermediate support to the roof beams along their length, and uplift from wind has to be counteracted either by tie downs at the end or by the deadweight of the roof. Although easy to analyse and with their structural behaviour easily understood visually, one has to pay extra for such masts and tie downs and, in the extreme, these masts have become cable-stayed flagpoles. Such a system is often not a structurally economic method of building, although can provide the basis for an effective and economic architecture.

It is the membrane action roofs, surface stressed structures, which have represented a new approach to design. The traditional approach in buildings has been to reduce deflections and deformations to preserve the integrity of the claddings and partitions, and so loadings have been resisted by increases in forces within the structure. Conversely, a surface stressed structure aims to achieve a minimum increase in force level, and thus a minimum need for expensive material, by distributing loading by an acceptable change of shape.

In surface stressed structures, the membrane is prestressed to form a load carrying system. This membrane can be either a coated woven fabric, a net of steel cables or an unreinforced structural foil. The prestress can be induced either by tensioning the surface via the boundary and supporting elements, or by pressure acting on one side; in which case it is a pneumatic structure. By using high strength materials in tension, surface stressed structures can provide a structurally efficient solution with a range of interesting architectural possibilities.

These structures are geometrically complex and have to be accurately prefabricated in their entirety (Fig 1.4). Consequently, the bulk of the work in the design office is spent on processing the geometry of all the components. Up until twenty years ago the only way to develop the geometry of a surface stressed structure was by physical modelling. However, to achieve sufficient accuracy this method took time and was expensive in terms of design resources. Improvements in the power of computers and developments in software have resulted in great advances in CAD systems for processing these structures rapidly and in a user friendly way (Fig 1.5).

However, it is still necessary to understand the physical principles governing behaviour of such structures and their materials in order to be able to utilise this software to advantage.

## 2 FORMFINDING

The process of formfinding is that by which the prestressed equilibrium form is developed. The objective is to create a model of the intended structure from which the geometry of the components can be found and in which the forces, stresses, volumes and environmental responses are known. As discussed

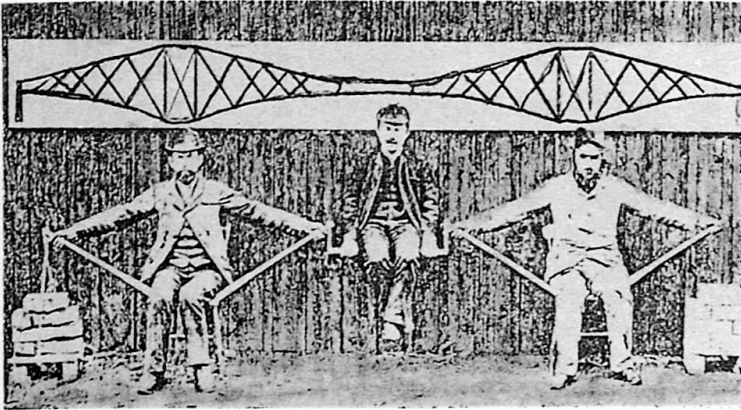


Fig 1.1 Fowler and Baker's Design for Forth Bridge

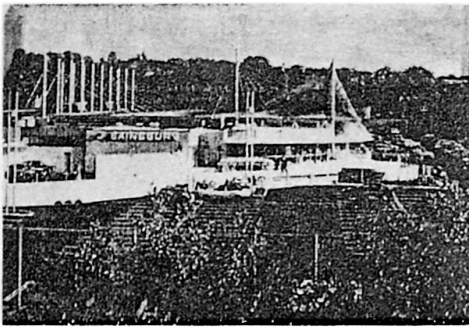


Fig 1.2 Roof at Sainsbury's Store, Canterbury

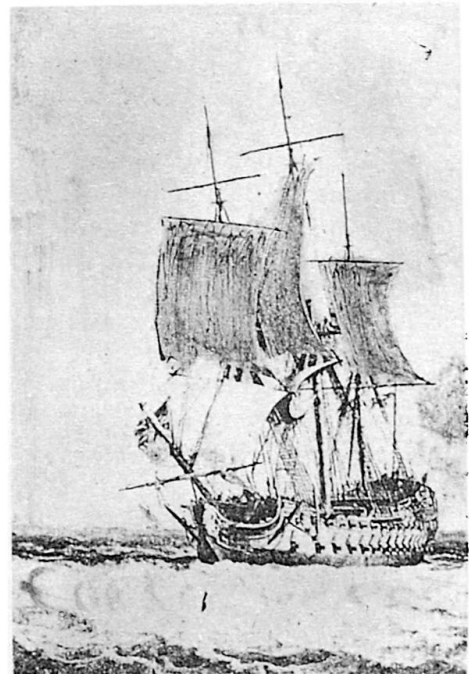


Fig 1.4 An early tension structure

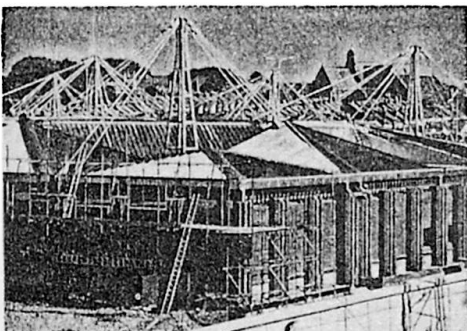


Fig 1.3 Tesco Supermarket Roof, Bristol



above, this can be done by physical modelling, geometrical calculations or by calculations involving static equilibrium of the computer.

Originally, accurate physical modelling for cable net structures was carried out using fine wire and small cable clamps. This method was used by Frei Otto for both the West German Pavilion at Montreal and for the swimming pool structure at the Munich Olympic Park [Ref 1]. All the component geometry was then measured from these models and the forces in the elements were all calculated by hand, generally using equation (b) of Fig 2.1. With experience and by choice of the appropriate formulae in Fig 2.1, one can make estimates of the forces in cables and fabrics supporting masts, and anchorages on the basis of the preferred form. In a real situation the stretch of the cables or fabric under externally applied loadings allowed the curvatures to change, usually reducing the forces caused by local 'high' load concentrations. Movement of the boundary cables caused by stretch in the anchorage system, or in an adjoining field has the same effect. Hence a full and accurate analysis can only be carried out using a non linear computer program which takes into account the displacements of the surface under loading and calculates the forces under the 'improved' geometry after deformation under load. Techniques used in our office are based on 'dynamic relaxation' the theoretical principles of which are given in Fig 2.2 [Ref 2].

### 2.1 Calculation of static equilibrium by computer

In this method the surface is modelled as a pattern of elements, usually triangles (or as bar elements in the case of cable nets). In the form finding mode, the membrane elements are set to have a constant predetermined stress no matter how much they change their size. Boundary cables can be modelled as elastic cables with a given length, or can be assigned specified tensions. Masts, tie backs, edge beams and arches can also be included in the model. The same model can be used for load analysis and for establishing the cutting patterns and cable lengths. The TENSYL suite is our office program and it is constantly being improved and updated [Refs 3, 4 and 5].

In TENSYL the shape is controlled by specific warp and weft stresses in the various areas of fabric, thus necessitating a trial and error procedure to get the required form. However, with the increasing capacity and speed of computers and the development of user friendly programs, the trial runs take less time, and data can be carried quickly so that the required form can be readily developed. The operator must nevertheless understand the physical principles involved.

These programs can also provide accurate analysis of the structure under loading. For this, the specified stress triangular elements of the formfinding are replaced by elastic elements with specified load extension behaviour appropriate to that selected for construction. These are then loaded with gravity or pressure loads, either singly or in varying combinations. User friendly graphics enable rapid evaluation of these results by both colour coded stress ranges and stress vector printout. Such computer aids make adjustment and improvement of the structure form easy and commercially possible without a severe setback to the design process, thereby enabling convergence on into the detail design of the components.

## 3 STRUCTURAL PERFORMANCE AS A FUNCTION OF FORM

A highly stressed membrane must be supported all round by a boundary which makes a closed, but not necessarily circular, ring. A uniform stress surface within a boundary is known as a minimum surface (Fig 2.3) - the minimal surface bounded by four cables with two masts.

A minimal surface, within a given defined boundary, has the least possible surface area and the minimum strain energy; hence it can be said to have maximum structural efficiency. It is possible to modify the surface by changing the ratio of stresses in the prestressed condition. From the point of view of overall design requirements, it may be desirable to do this to improve the headroom in the building,

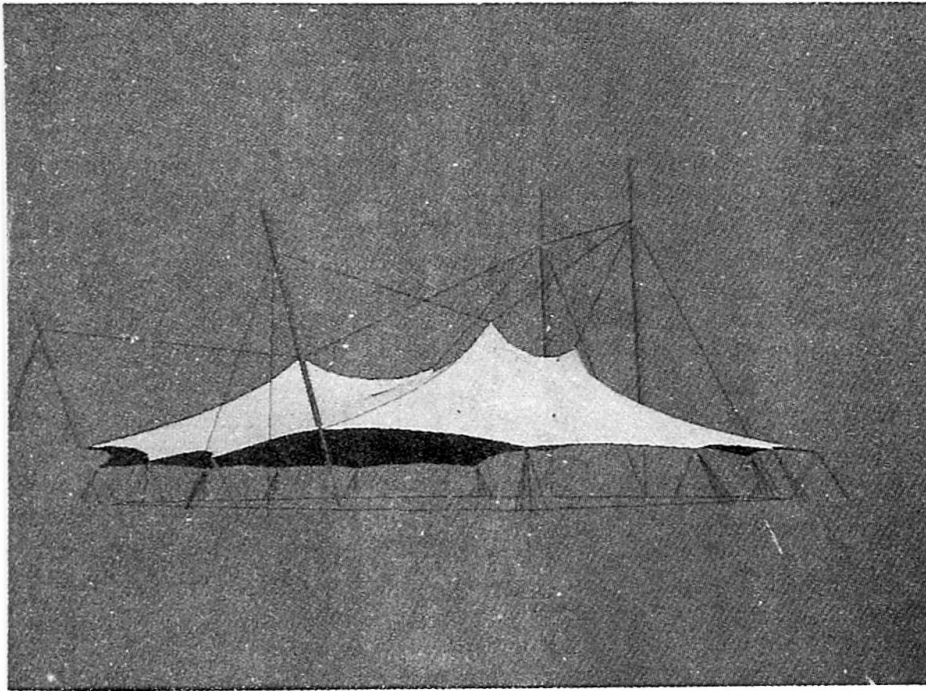


Fig 1.5 CAD Representation of a Surface Stressed Structure

Approximate Methods of Calculation

Cylindrical membrane strip of unit width under pressure loading



- $w$  = load/unit length
- $R$  = Radius of arc
- $T$  = Tension

$T = w \times R$  --- ①

2. forces in hanging cable under uniform vertical load



- $S$  = SPAN
- $d$  = Central dip
- $l$  = length of cable

Cable hangs in a parabola such that

$$y = \frac{4d}{S^2}(Sx - x^2)$$

Horizontal force  $H = \frac{wS^2}{8d}$   
 vertical force  $V = \frac{wl}{2}$   
 $T = \sqrt{H^2 + V^2}$  --- ②

Fig 2.1 Basic Geometry of Surfaces

Approximate Methods of Calculation

Cylindrical membrane strip of unit width under pressure loading



- $w$  = load/unit length
- $R$  = Radius of arc.
- $T$  = Tension.

$T = w \times R$  --- ①

2. forces in hanging cable under uniform vertical load.



- $S$  = SPAN
- $d$  = Central dip
- $l$  = length of cable.

Cable hangs in a parabola such that

$$y = \frac{4d}{S^2}(Sx - x^2)$$

Horizontal force  $H = \frac{wS^2}{8d}$   
 vertical force  $V = \frac{wl}{2}$   
 $T = \sqrt{H^2 + V^2}$  --- ②

Fig 2.2 Equations of Equilibrium





to modify the visual appearance of the surface, or to improve the performance of the particular structure to the range of loadings it must resist.

If this surface is made from woven fabric or an orthogonal cable net, there are two sets of tendons at right angles to each other which ideally would follow the lines of principal curvature so that they then have opposing curvature. Prestress is required to stiffen the surface against deflection. If the surface is flat, then prestress provides the only resistance to deflation. If it is well curved, then the elastic properties of the membrane provide the resistance to deflection regardless of the level of prestress, up to the point where yarns go slack in one direction, or where under a local load the curvature becomes synclastic. This effect becomes very important under snow loading.

### 3.1 Behaviour under load

Wind loading on such a surface consists of a random and varying set of surface pressures in which uplift generally dominates. The downward pressures are taken by the sagging set of tendons and the uplift pressures by the hogging tendons. The tension along any particular tendon remains sensibly constant so local high pressures are taken by the surface deflecting. The radii of curvature consequently change and the equations of equilibrium are satisfied. This means that a stressed surface is a load averaging system - the maximum tension in a particular hogging tendon is caused by the maximum average uplift pressure in the area of the tendon.

The same principle applies for down loads. Snow loading tends to slide down the steep slopes and remain on the flatter slopes. This results in high local patch loading on the horizontal areas, with high local load producing large local deflections. As discussed above, the local tensions are not particularly high. The increase in tension is spread over a large area of the structure with a corresponding strain in the fibres. This results in a large increase in strain energy in the structure which must be balanced by the decrease in potential energy, such as the local load times its deflection.

Within the limits tolerated by the chosen cladding system, deflections of large magnitude are not themselves a problem provided they are not accompanied by severe local changes in shape or excessive in-plane shear distortions. However, a large deflection can cause problems with ponding if it is such that there is no longer any drainage away from the deflected pocket. Once this occurs, any additional rain or melt water will run into the pocket which will become larger and larger until the fabric tears or the supporting structure collapses. On a tensioned fabric structure, the problem of ponding can be avoided by ensuring that there are no flat horizontal areas. On canopy structures which are used primarily in the summer, it is a sensible precaution to install drainage grommets in areas where ponding can occur.

Air supported structures also suffer from ponding if the local snow load exceeds the inflation pressure. Stadium structures with a primary net of cables are particularly sensitive to ponding since the snow tends to drift into the cable valleys. A means of preventing ponding therefore needs to be considered in the design stage.

### 3.2 Dynamic behaviour

Surface stressed structures tend to have large deflections compared with bending stiff structures. They also have natural frequencies of oscillation which could theoretically respond to wind flow or turbulence to produce dangerous free oscillation. This behaviour has been studied extensively by Davenport and others [Ref 6] but in practice coherent wind induced oscillations have not been observed in properly tensioned prestressed membrane structures.

The same is not true of air supported structures. In this case it is the mass of enclosed air which controls the oscillation of the roof. If the shape of the roof is such that the roof is locally deflected inwards, this can activate oscillations of the internal air which can become resonant. For large and important

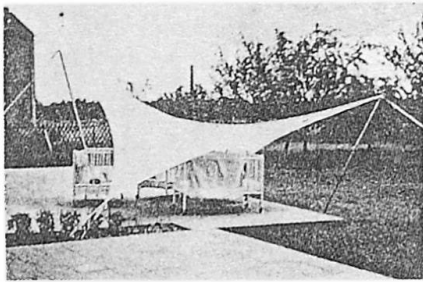


Fig 2.3 Minimum Surface Bounded by 4 Cables and 2 Masts

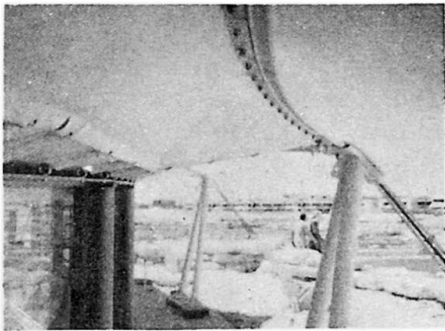


Fig 4.1 Eye Loops, Boundary or Ridge Cables on Masts

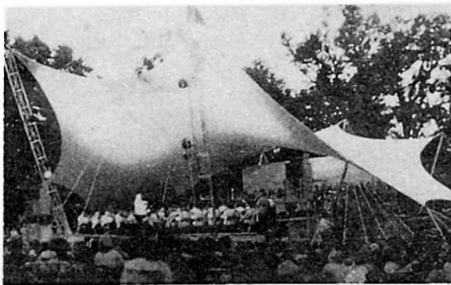


Fig 4.2 The Washington Symphony Orchestra Tent

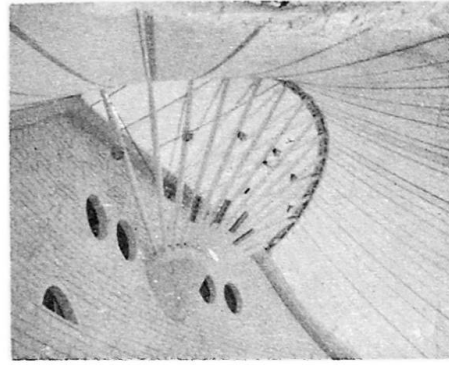


Fig 4.3 Conical or Pseudo Sphere Form

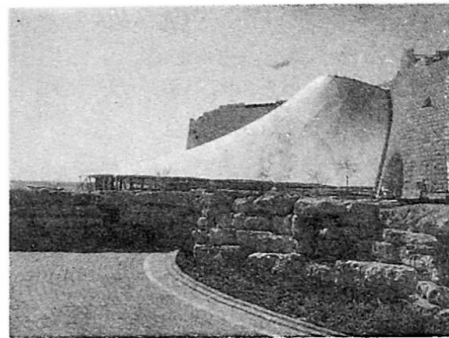


Fig 4.4 Diplomatic Club, Riyadh



Fig 4.5 The Heart Tent, Diplomatic Club, Riyadh



structures this effect should be studied in a wind tunnel during the design stage.

#### 4 EXAMPLES OF FORM

Each field of fabric within a whole structure which may be composed of a number of such fields must be bounded and determined by the type of supporting elements at its structural boundary. These can be rigid elements such as beams, walls, arches or flexible cable elements such as eye loops, boundary or ridge cables on masts (Fig 4.1). As it is difficult to form a useful space with a single 'saddle' surface, a building will usually consist of a number of fields arranged together and anchored to a range of boundaries. The correct determination of the boundaries from the range outlined below is probably more significant to the overall success of the design than choice of the surface itself.

##### 4.1 Masts and ridges

A membrane cannot be supported by a point. Generally at a mast point there will be two ridge cables, sometimes three or four, which transfer the uniform stress in the fields to the concentrated load at the mast. A recent example of a tent with such masts and ridges which has been developed by the Practice is the Washington Symphony Orchestra Tent (Fig 4.2).

##### 4.2 Conical forms

With conical or pseudo sphere forms, there are often a large number of radial cables coming together at the mast (Fig 4.3). These usually lay freely under the fabrics, the tension is constant and the fabric can slip over the cables. Typical examples of these forms from the Practice are found in the Diplomatic Club, Riyadh (Fig 4.4), with its Heart Tent (Fig 4.5) and the Munich Aviary (Fig 4.6).

##### 4.3 Ring supports

A single membrane can be supported by a large ring. Again, soap film modelling demonstrates the problem. If a film is created between an inner and an outer ring, the inner ring can be lifted to form a doubly curved surface. If the rings are moved further apart, it will be found that at a certain point the film will always burst. This happens because the meridional radius of curvature becomes greater than the circumferential radius. At this point the conditions of equilibrium cannot be met so the film bursts. With a real fabric, the meridional tension can be greater than the circumferential tension, and reinforcement can be added by doubling the cloth or by broadseaming so that the ring can be smaller than that which the soap film theory predicts. Even so, a relatively large ring is still required. An example of this technique can be seen in the permanent structure for the new Mount Stand at Lords (Architects: MHP/Engineers: OAP).

##### 4.4 Humped tents

Originally this system, which does not use cutting patterns, was devised by Frei Otto. The woven fabric is made up flat and without shaping along the seams. During erection the fabric is supported on domed supports so that the angle between the directions of weave are changed, so allowing it to distort into a doubly-curved surface over the support. The Staffordshire House atrium roof (Figs 4.7 and 4.8) is a humped tent with a fully patterned membrane.

##### 4.5 Funicular arch support systems

It is possible to support a membrane by an arch which has no bending and is itself stabilised by the membrane. This form finding process can only be carried out using an equilibrium computer process. The arch is only moment-free under ideal prestress conditions. Under imposed loads, moments are generated and there are stability problems requiring the addition of bending stiffness. Recently engineers

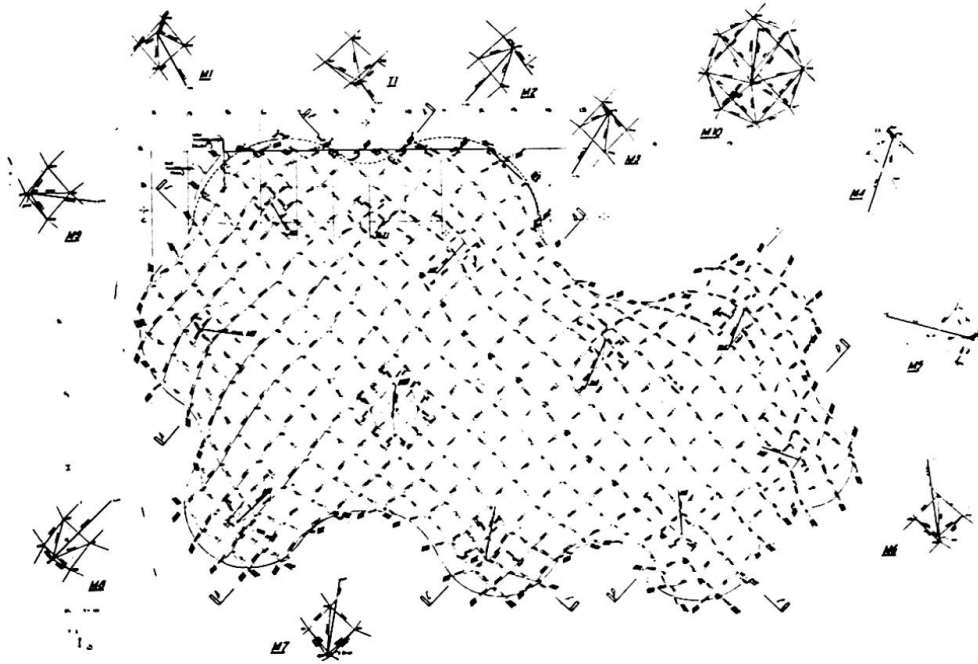
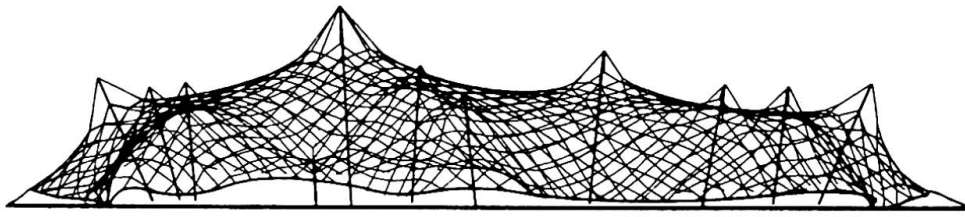


Fig 4.6 Munich Aviary

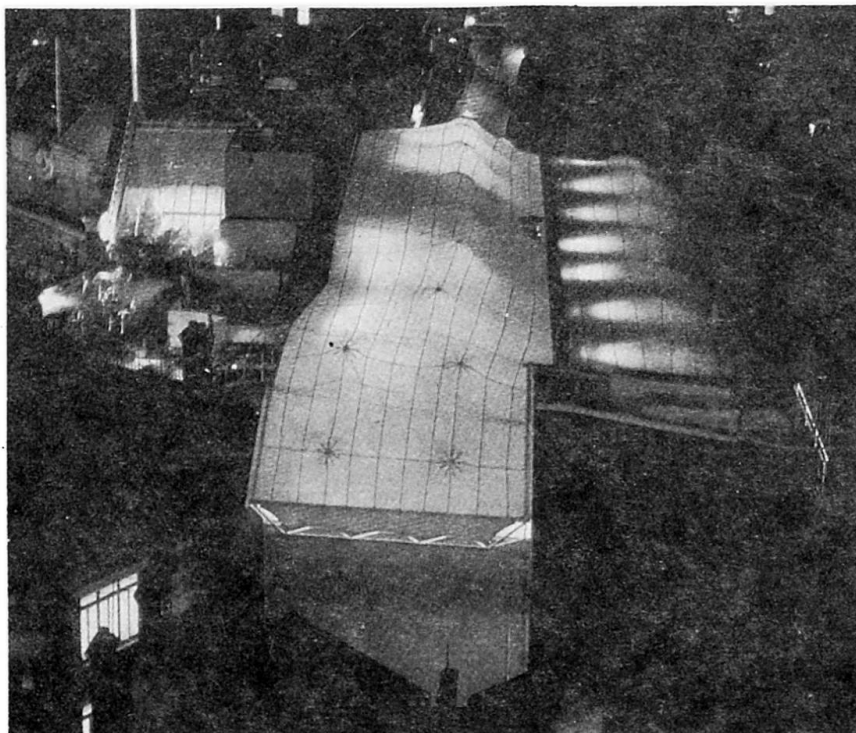


Fig 4.8 Staffordshire House Atrium Roof



Schlaich and Partners at Munich Skating Arena, and we ourselves at Stoke Garden Festival (Fig 4.9) have preferred the self-stabilised trussed arch form.

#### 4.6 Surfaces supported by compression ring beams

A system of boundary arches to the net has been used for a roof at the Calgary Olympic Saddle Dome (Fig 4.10) engineered by Jan Bobrowski and Partners, for which Buro Happold were the proof engineers. In these examples the cladding is of reinforced concrete plates and the finished structure becomes a concrete shell. The Tsim Sha Tsui Cultural Centre Roof in Hong Kong is of this type.

#### 4.7 Air supported cable restrained roofs supported on a ring beam

For the US Pavilion at Expo '67 at Osaka, Davis and Brody, the architects, as a cost saving exercise, adopted a low profile cable restrained air supported roof enclosed by an earth berm - an idea which had been promoted by the father of air supported structures, Wally Bird. To solve the problem of anchorage, the engineer David Geiger proposed to use a moment free compression ring. With the diagonal cable arrangement this ring became elliptical in form. The roof material was, in this case, PVC coated glass fibre cloth laced to the cable net.

Bird and Geiger realised that this form of construction could be used for covering stadia. The development of teflon coated glass fibre cloth which met the US fire requirements allowed the design of these structures to proceed. The first developed was the Unidome, followed by the Silver Dome at Pontiac where the air supported roof was adopted after construction of the stadium had commenced. A similar development was anticipated by our own project at 58°North (Fig 4.11).

Subsequent developments in the USA have been aimed at minimising first costs by using larger panels of cloth, with performance in service however, being neglected. Some of these stadia in the northern half of America have experienced problems with snow drifting in the valleys causing local inversions which can lead on to damage and total deflation of the roof. The failure of one at Minneapolis will be discussed at the Conference.

The cure lies in the use of smaller panels, a higher inflation pressure and greater snow melt capacity, together with better form determination and patterning - all of which increases the initial cost. Air supported structures however, remain the most economic structural type of enclosure of large spans but they require to be properly detailed and managed.

## 5 ONGOING DEVELOPMENT

The currently used textiles for architectural purposes are PVC-coated polyester fabric and PTFE-coated glassfibre. New fluoropolymer coating materials offering improved performance are being developed all the time and we are currently working with pure woven PTFE fabric for flexible membranes for folding structures. We are also developing ways of supporting glass on cable nets and new ways of generating nets so that the meshes are flat without twist.

As a development from 58°North foils and films of polymer without a structural fabric are of growing interest to us. The ETFE and FEP foils available have completely different mechanical properties from fabric supported membranes, being isotropic, and of low stiffness, yet having a fair resistance to tear propagation. To date, such foils have been used to admit a high measure of vector modelled light for leisure activities, swimming pools and horticultural uses by way of individual inflated cushions up to 5.0m or so in size, restrained by small stainless steel wires and held within an overall structural grid. They are highly translucent and very inert.

Fig 4.9 Staffordshire House Atrium

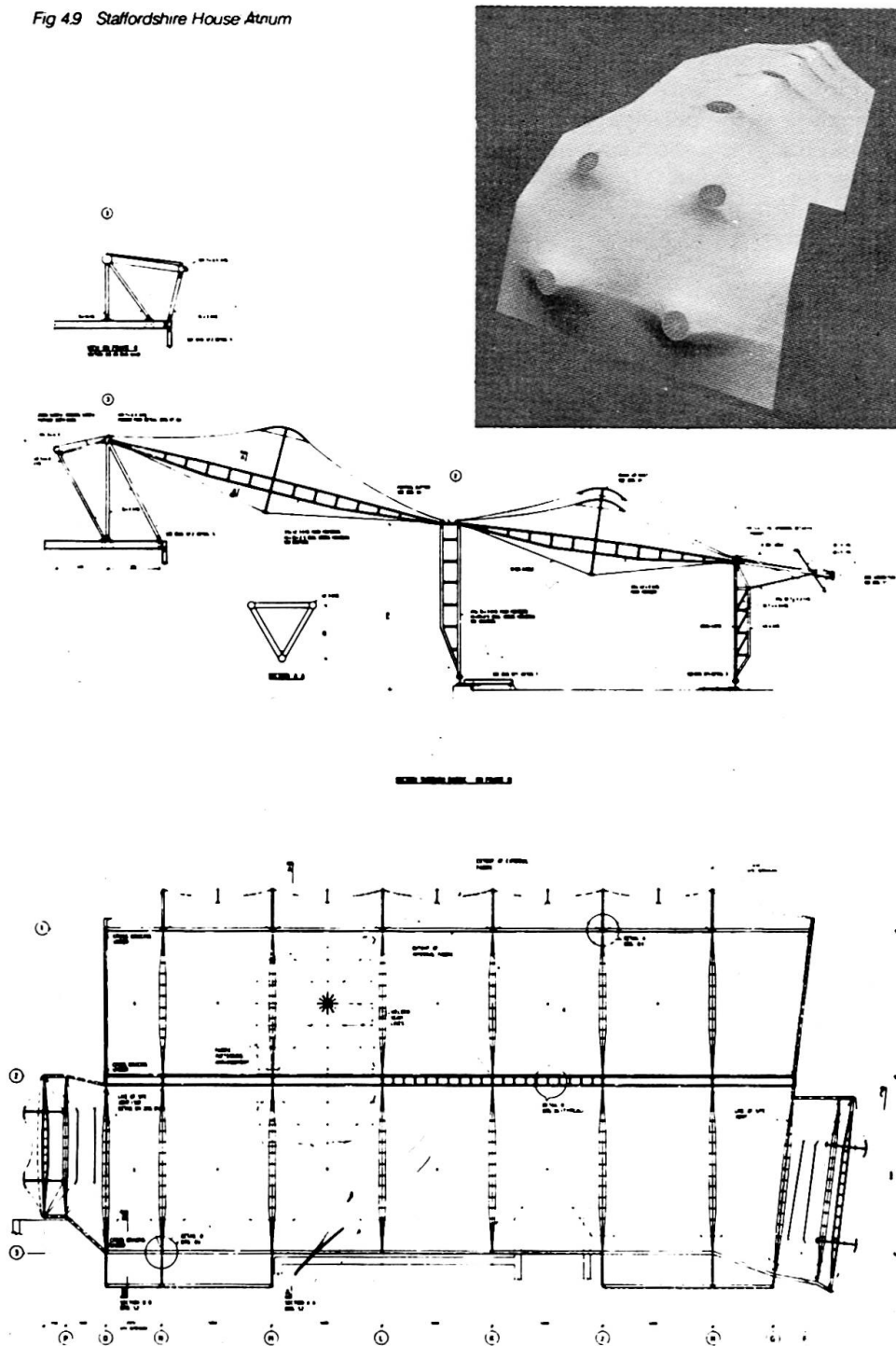


Fig 4.7 Staffordshire House Atrium Roof

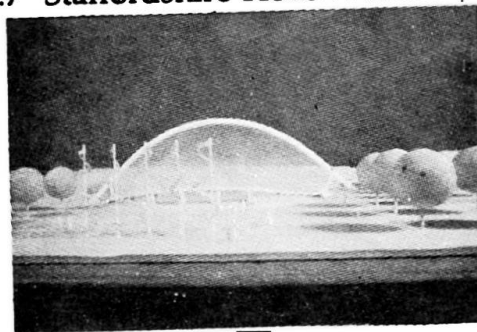


Fig 4.9 Stoke-on-Trent Garden Festival



Although clearly not as versatile as more conventional fabric based materials, they are highly appropriate where a support matrix can be provided. Indeed because these cushions also provide a thermal performance rather better than double glazing for approximately a quarter of the weight, we proposed their use as the principal covering element to the 58°North project. As a development of this earlier proposal the Practice is now working on a design for an atrium for a new hospital in London with architects Sheppard Robson (Fig 4.12). This will use 4.0m<sup>2</sup> inflated cushions of a clear foil material, ethylene tetra fluoro ethylene (ETFE), supported within a grid shell of GRP ribs. This will ensure a light transmission equal to that of glass, yet will require a far less heavy support system across the atrium.

And finally an airship (Fig 4.13).

#### ACKNOWLEDGEMENTS:

The considerable advance in the base technology of this whole field has been made through the interaction of designers of practical problems within our firm, and from outside in practices with the thoughts and efforts of researchers both in Stuttgart, at the Sonderforschungs Bereich SFB 64 Weitgespannte Flachentragwerke (Long Span Structures Group), and closer to home with the Wolfson Flexible Structures Group at the University of Bath and at City University, London .

#### REFERENCES:

- (1) OTTO F, HAPPOLDE E, RICE P et al 'Frei Otto at Work' Architectural Design March 1971
- (2) BARNES M R 'Applications of dynamic relaxation to the design and analysis of cable, membrane and pneumatic structures' Second International Conference on Space Structures Guildford 1975
- (3) 'Air Supported Structures - The State of the Art' Conference Institution of Structural Engineers June 1980
- (4) 'The Design of Air Supported Structures' Conference Institution of Structural Engineers July 1984
- (5) AFSF Proceedings of a Conference on Architectural Fabric Structures Orlando 1984
- (6) DAVENPORT A G 'The response of tension structures to turbulent wind - the role of aerodynamic damping' First Oleg Kerensky Memorial Conference Institution of Structural Engineers June 1988

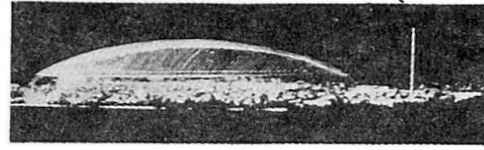


Fig 4.11 58°North

Fig 4.10 Calgary Olympic Saddledome

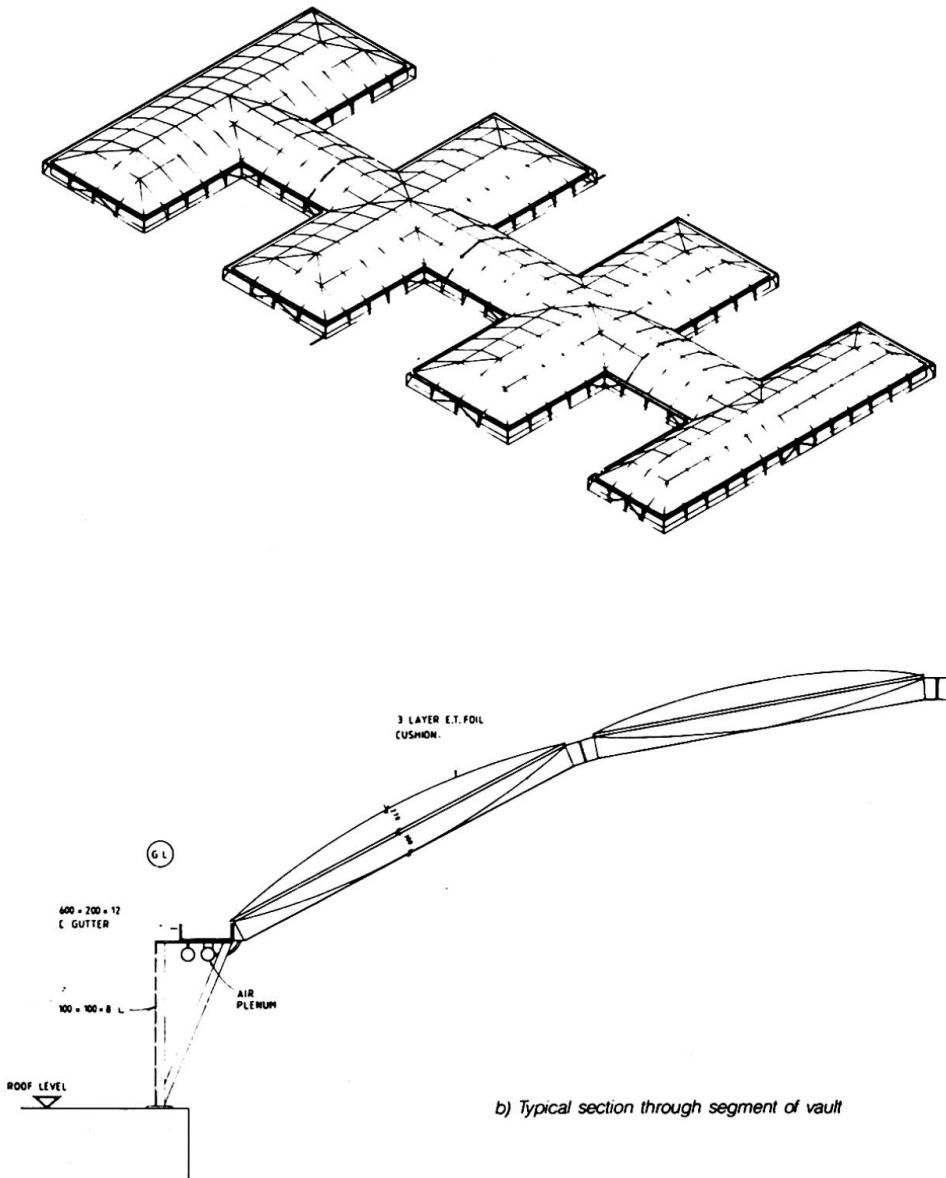


Fig 4.12 Westminster & Chelsea Hospital Atrium Roof



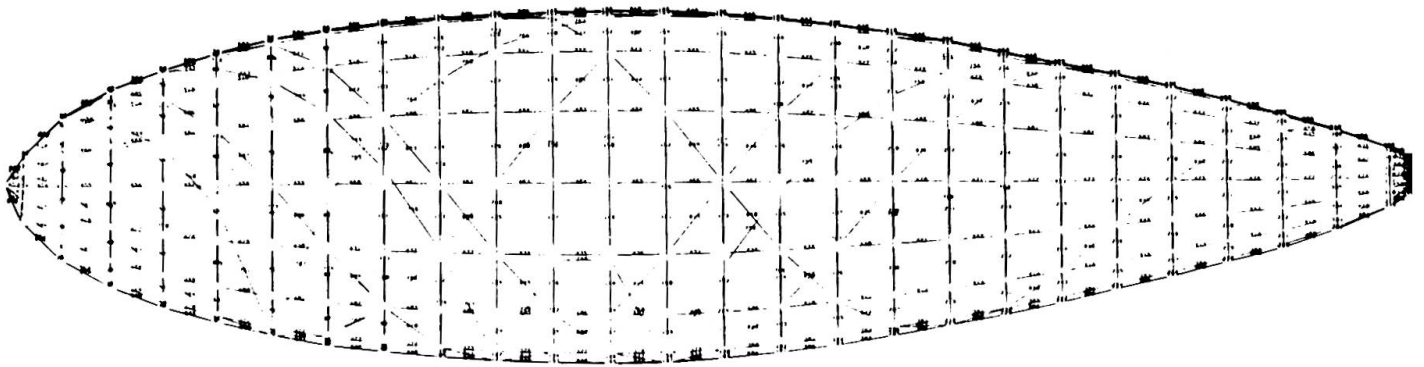
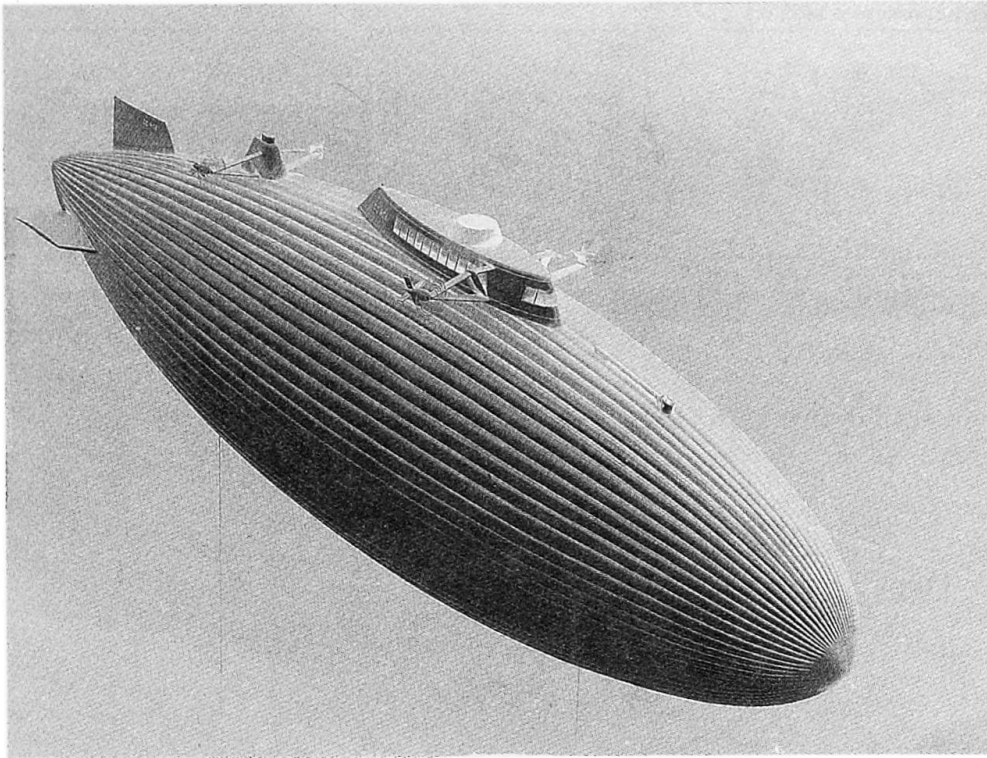


Fig 4.13 Airship

## **Movable Membrane Roofs for the Arenas in Nîmes and Zaragoza**

Couvertures amovibles en toile pour les arènes de Nîmes et de Saragosse

Wandelbare Membrandächer für die Arenen in Nîmes und Saragossa

### **Rudolf BERGERMANN**

Consult. Eng.  
Schlaich Bergermann & Partner  
Stuttgart, Germany



### **Jörg SCHLAICH**

Consult. Eng.  
Schlaich Bergermann & Partner  
Stuttgart, Germany



Professor and Director of the Institut für Tragwerksentwurf und -konstruktion (Inst. for Structural Design), formerly called Institut für Massivbau (Inst. for Concrete Structures) at the University of Stuttgart and Consulting Engineer with Schlaich Bergermann und Partner, Stuttgart, Germany.

### **SUMMARY**

A general survey of the different movable roof concepts is given. Two recent movable roofs, the membrane cushion roofs in Nîmes and the partly fixed retractable membrane roofs in Zaragoza are described.

### **RÉSUMÉ**

Dans un premier temps sont évoqués d'une façon générale, les différents types de couvertures amovibles. Ensuite sont décrites deux toitures amovibles récentes: la "lentille pneumatique" de Nîmes et la couverture toilée semi-rétractable de Saragosse.

### **ZUSAMMENFASSUNG**

Zuerst wird ein allgemeiner Überblick über die verschiedenen Konzepte wandelbarer Dächer gegeben. Dann werden zwei neuere wandelbare Dächer beschrieben, das Membrankissendach in Nîmes und das teils feste, teils bewegliche Membrandach in Saragossa.



## 1. GENERAL SURVEY

There are several occasions, where we might want to have the choice for changing from an open air location to a covered, roofed one and vice versa: movable roofs are the solution! Generally, there are 3 different concepts for using such a roof influencing consequently their structural layout:

- A temporary roof is needed from time to time to protect against too strong sunshine or more often, especially in our continental climate, to protect against rain. Thus only a roof, which can be moved in or off within a short period of a few minutes, will provide an adequate shelter.

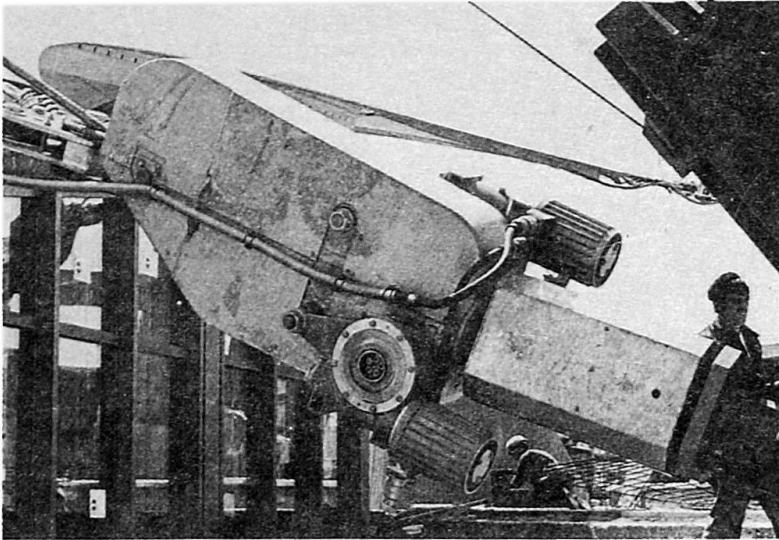
Outdoor theatres, sports facilities like tennis courts, restaurants or other recreation and leisure areas may, although generally more comfortable in open air use, look for such a bad weather protection, which only guarantees uninterrupted performances and full use. - Roofs for this type of use are normally not designed to withstand heavy winterstorms or snow loads.

- The second group of roof serves the same purpose in summer, but in addition covers and protects the theatre or sports area also during winter. The necessity to carry snow loads roughly at least triplicates the maximum loads which result in a much stronger, stiffer and hence less foldable membrane and in much thicker cables to suspend the roof with of course rapidly decreasing ductility. So the roof adds not only weight and loses flexibility, but also adds costs. An alternative would be to provide a snow melting system by blowing warm air underneath the membrane, but it seems to be quite risky to rely totally on such equipment, especially, when it will be needed and used only very rarely but should be maintained and checked regularly. Therefore it is advisable, when using a melting system, to nevertheless stick to a much reduced but nevertheless adequate level of safety in case of a mechanical system-shortfall.
- The third type of roof is installed only for the winter season and will be taken off in spring for the open air summer season. Although this roof is only 'moved' twice a year, it should be mentioned here, since nearly all roofs of this type are membrane structures and since this type is the most popular of all movable roofs.

Different requirements need different design approaches. For the first roof type the most simple design shows membrane strips, hooked to parallel ropes, stressed between two rigid supports. The membrane strips, i.e. their front or end piece, are pulled forward and backward manually by thin diameter endless slings, moving on rollers at those same supports. Similar systems, the vela, had been in use already in the old Roman theatres for shading the arena and they can be seen today in garden restaurants or small theatres, doing the same job only with more modern materials like a PVC-coated polyester membrane, steel ropes and nylon slings. By welding the membrane strips together the roof today normally is continuous, protecting a larger area also against rain.

While the membrane moves along the parallel ropes, it is folded - or unfolded - in one direction, the distance of the hooks determining the fold depth. The folded membrane can be parked/stored on either end. A variation to the parallel is the trapezoidal rope arrangement; here the folded membrane - folded in both directions - can only be parked at the narrower end, widening, while it is pulled along the spreading ropes.

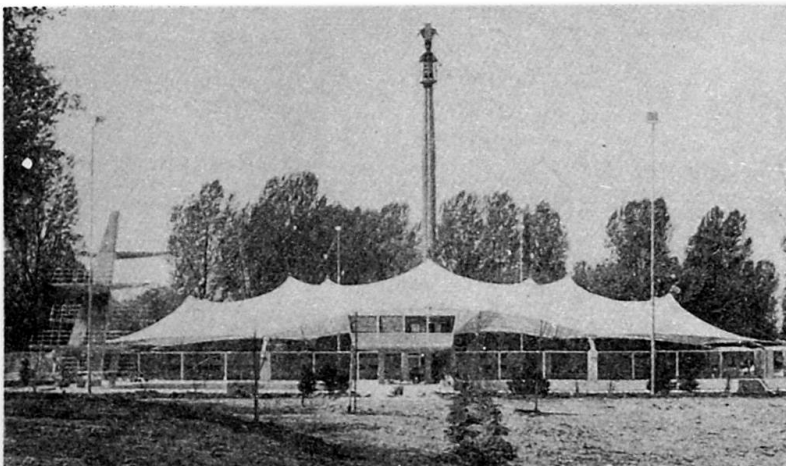
In both cases the membrane is moved along parallel or semi-parallel straight ropes and hence the membrane also remains plain. Therefore it is obvious that this type of roof is rather flexible under wind loads and therefore its application is limited to smaller roofs of a few hundred squaremeters only.



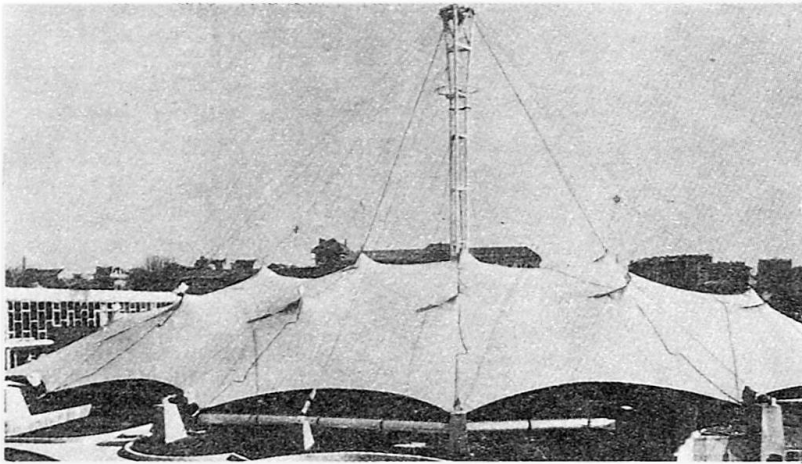
**Fig. 1**  
Swimming Arena Düsseldorf  
Membrane roof in closed  
stretched position.



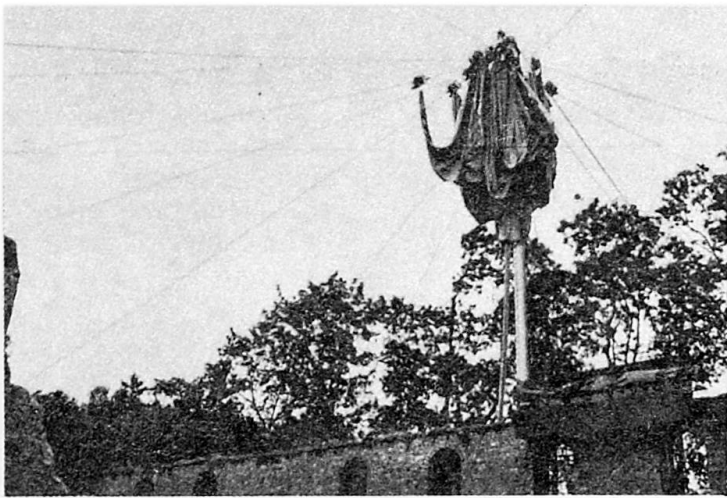
**Fig. 2**  
Swimming Arena Düsseldorf  
Membrane roof in open-air posi-  
tion; the tractors have pulled up  
the membrane edges along the  
main cables.



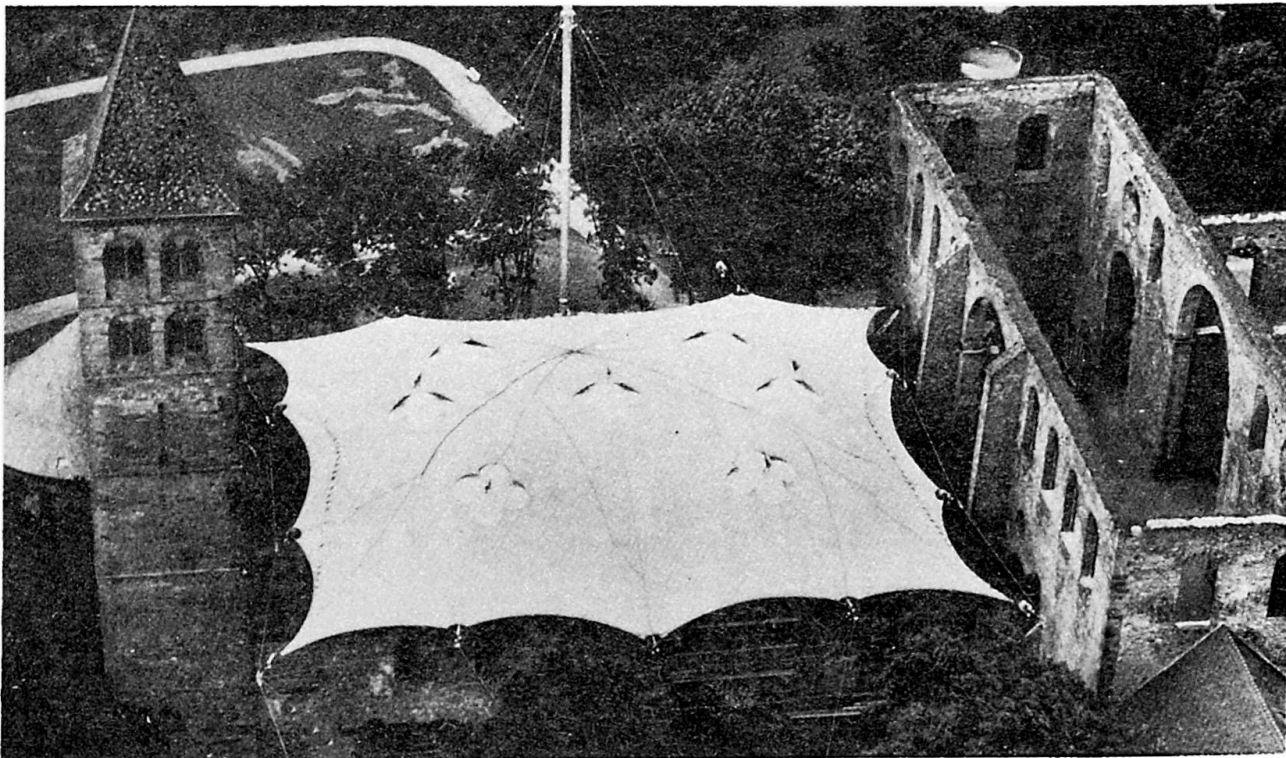
**Fig. 3**  
Swimming Arena Düsseldorf  
Tractor in base position, docked  
to the anchorage.



**Fig. 4**  
Swimming Arena  
Boulevard Carnot, Paris.  
Membrane roof covers an area of  
2 200 m<sup>2</sup>.



**Fig. 5 + Fig. 6**  
Theatre Bad Hersfeld  
Membrane roof of 1 450 m<sup>2</sup>, in  
squeezed top position and in closed  
stretched, nearly rectangular  
shape.



For larger areas and larger loads the membrane should have a double curvature in order to prestress it and to get more stiffness and stability. Most structures, built so far, show a synclastically curved membrane dome, which is suspended from a number of main cables at numerous support points distributed uniformly over the membrane area and put under prestress against these cables, while rigidly held along its circumference (see Figs. 1 - 6). Of course, the main cables must all lead to and be anchored in one central top point, from where they can spread out to form a circular, elliptical or any other roof shape in plan. Only so the membrane can from its stretched shape move and fold together to one central bulb.

Two schemes have been applied so far for moving the membrane:

- The main cables are fixed to their anchors and don't move. The membrane support points are movable - sliding - along the main cables. The outer membrane edge is attached to a tractor, which travels along the main cable and thus pulls or pushes the membrane for closing or opening the roof. These tractors (see Fig. 3), mostly electrically driven, must be strong enough not only to move the membrane, but also to prestress it to a sufficiently high level, since most of these roofs belong to type 2., i.e. they are designed for snow loads. Several roofs of this system have been built in France and Germany in the seventies mainly to cover swimming arenas, as Figs. 1 - 6 demonstrate.
- For extremely large roofs the membrane can't be moved any longer by tractors, due to the excessive forces. Here every membrane support point must be directly suspended by a cable from the central top point and this cable itself pulls the membrane up when the roof is to be opened. The best example for this type and most spectacular, because largest movable membrane roof at all, covers the Olympic Stadium in Montreal. 21 main cables prestress the membrane and in winter, when it is permanently closed, carry the heavy snow loads to the tower tops. During the lifting operation the main cable forces are much smaller, therefore they roll over large diameter wheels in the tower top and are extended by smaller cables which actually lift the roof by pulling the main cables and which are small enough in diameter to be reeled on winch drums situated at tower base. While the roof moves up, 17 points along the outer edge are guided by winch cables from their lower anchorages, which later on are needed to pull the membrane down again and anchor it along its periphery. [1].

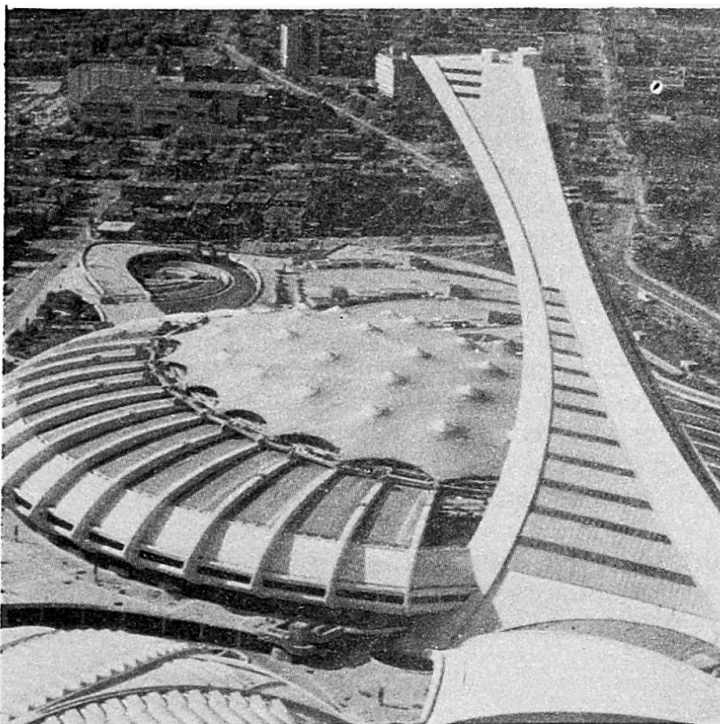


Fig. 7  
Olympic Stadium Montreal  
Membrane roof area: 20 000 m<sup>2</sup>;  
suspended from a 170 m high  
tower.



Nearly all structures of the third group, erected only for the winter season, are air-inflated membrane domes, most of them covering tennis-courts or other sports facilities. They are simple and quick to be erected and dismantled and very economical because they don't need more than the membrane itself, a simple anchorage and the blowers. Since a failure of such a dome would not cause severe damage, because it only would come down slowly to the ground due to a release of pressure, the dome design normally does not include snow loads; it relies on a melting system by warming up the blown-in air.

## 2. ROOF FOR THE ARENA IN NIMES

A more elegant and attractive version of these 'winter roofs' has been designed and built recently for the old Roman Arena in Nimes in France. The City wanted to use the central area of the arena, not only open air in summer, but also during winter for operas, rock concerts, different sports events or exhibitions, which required an elliptical roof of nearly 60 x 90 metres free span, covering upto 8,000 visitors.

Of course, the new roof should be extremely light in order not to overload the old structure, and all modifications to the old stone work should be kept to a minimum.

The structure consists of an air-inflated membrane cushion, which is edged by a steel ring. The flexible hollow box-type steel ring is supported by 30 columns, each of them about 10 metres high. Cable bracings at the vertices of the ellipse stabilize the roof structure.

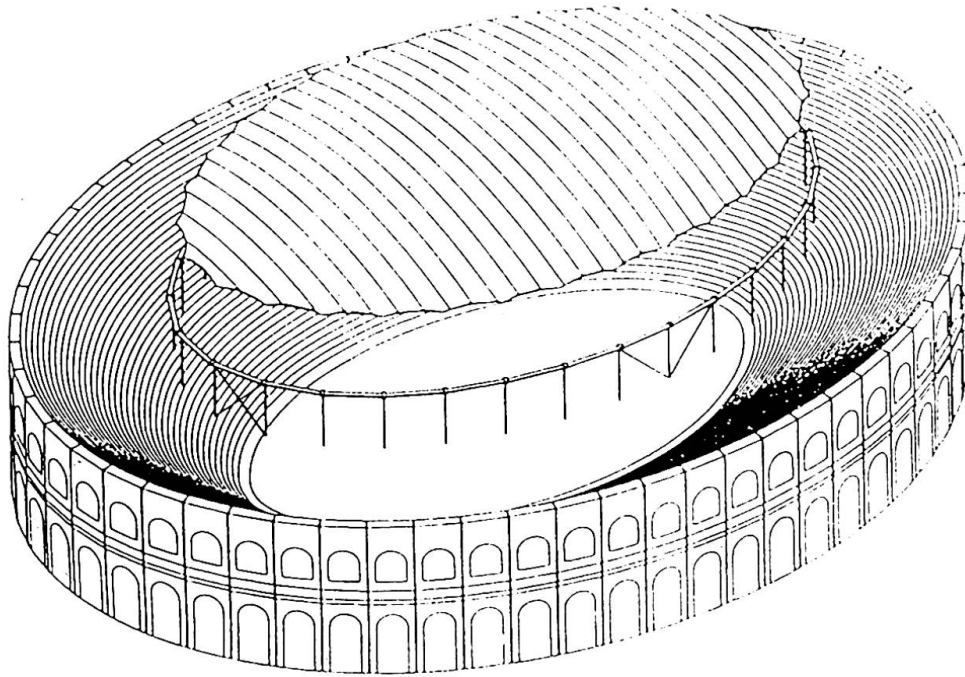
The maximum height of the upper membrane is 8.5 metres, which keeps the roof within the upper level of the outer old stone wall. The rise of the lower membrane of the cushion had to be limited by architectural and functional considerations to 4.2 metres. The resulting nearly doubled level of forces, acting on this slightly curved membrane, necessitated its reinforcement by a cable net.

The upper and the lower membrane are edged by 30 garland cables each. These garland cables transfer the membrane forces at 30 points into the steel ring.

An inclined transparent facade of 480 lamella-type elements of polycarbonate plates with light aluminum webs closes the "winter-hall" along its parameter.

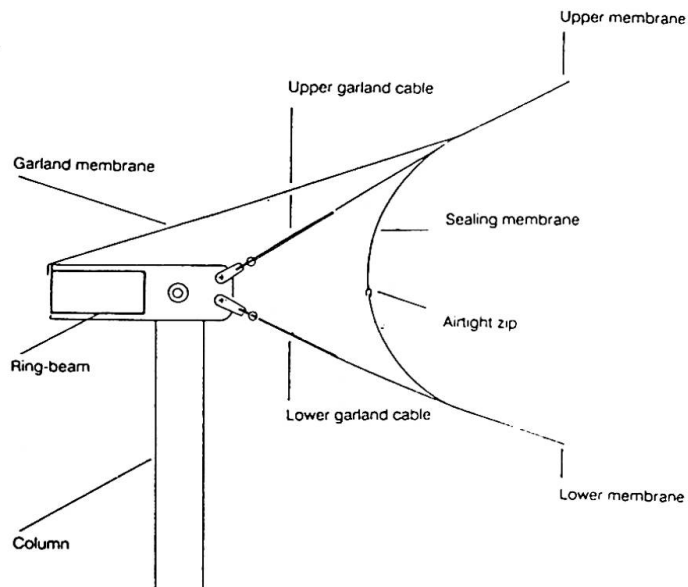
All structural details have been designed with due consideration of the annual erection/dismantling procedure. The steel ring, a welded hollow box beam with outer dimensions of 300 x 500 mm only, made of 25 mm plates, is polygonal and loaded at its 30 kink points by the membrane, but also totally stiffened and stabilized by the membrane cushion. The 30 elements of the ring are coupled by 2 large diameter pins at each joint only. The ring is situated eccentrically to and inside of the columns and its brackets are again fixed to the columns by large pins, which form a hinge to avoid bending in the columns, but which also facilitates the assembly and disassembly of this detail. The membrane cushion or their garland cables respectively, as well as the lower cable net, are also coupled onto these ring nodes. This concentration of connections in single points allows an easier organisation of the workers and also the equipment during the erection process. The tubular columns of 300 mm diameter are mere compression members with their hinges at top and bottom ends. They allow a stress-free deformation of the entire structure under temperature variation.

The membrane cushion consists of 4 different membranes: the upper and the lower one, each of about 4,000 squaremetres, the sealing membrane connecting those two and finally the garland membrane, which spans from the parameter of the cushion to the steel ring, covering the A-shaped openings inbetween.



**Fig. 8** Arena in Nîmes

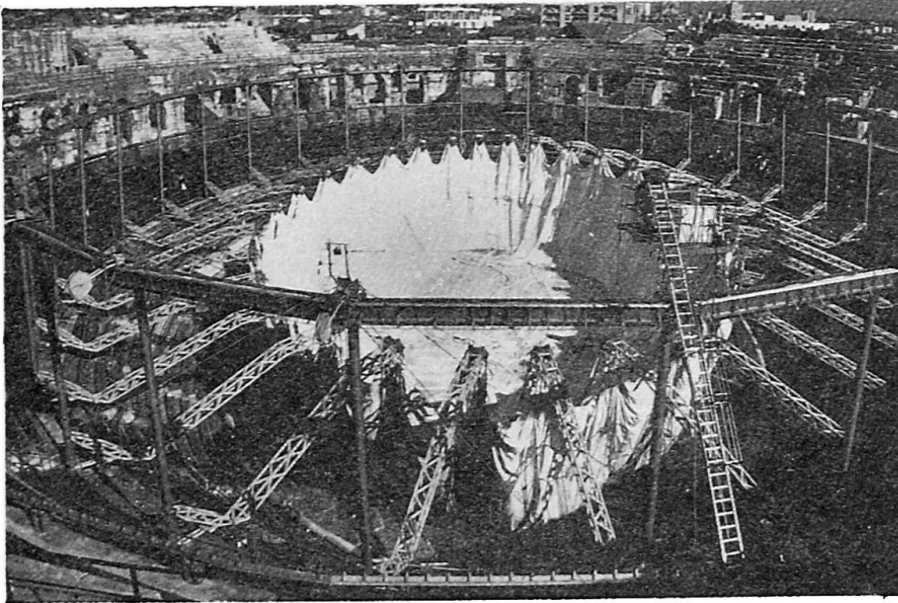
The main components of the roof structure: The air-inflated cushion with its garland-shaped edge, the steel-ring and the 30 columns with the four bracings at the vertices of the structure.



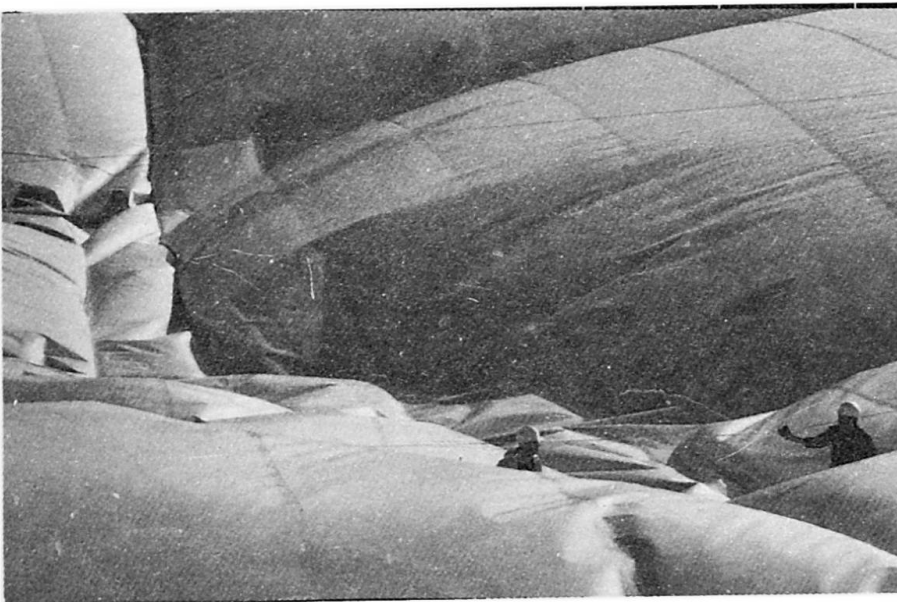
**Fig. 9** Arena Nîmes

Vertical section at the perimeter of the cushion.

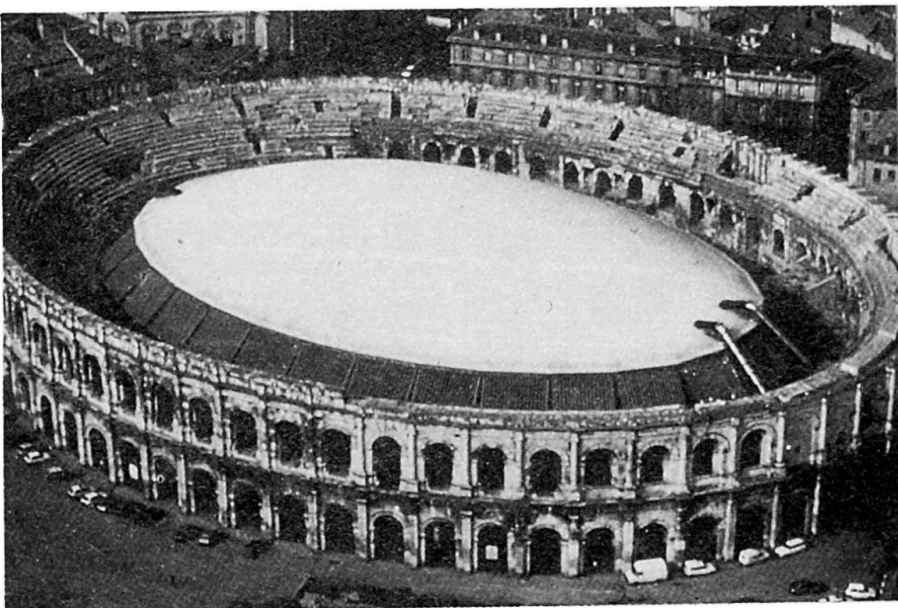




**Fig. 10**  
Arena Nîmes  
Membrane cushion during lifting by the help of 30 outriggers.



**Fig. 11**  
Arena Nîmes  
Membrane cushion during inflation lasting only 20 minutes.



**Fig. 12**  
Arena Nîmes  
Inflated membrane cushion



All membranes are PVC-coated polyester fabrics. This type of material has been chosen because of its good ability to be folded and stored each year, and because of its high load bearing capacity. Of course, the ultimate strength for the 4 types of membranes vary and go up to a tensile strength of 150/130 kN/m for the warp/weft direction under short-term loading and 23° C. The single 2.5 metre wide strips of each large membrane have been joined by a 80 mm high frequency weld and in addition 4 backstitch sewings. The lower membrane requested a reduced strength only, since it's lying on the cable net and therefore spans an area of 7 x 7 m locally only. The sealing membrane connecting the upper and the lower membrane and thereby completing the air-inflated cushion, can be opened along its equator. This allows separate handling and storage of the 2 large membranes. The 2 parts of the ceiling membrane can be joined by a loop-fastener which is responsible for the transfer of forces and by a zip which ensures proper air-tightness of the cushion. The translucent garland membrane is the only membrane which is not air-supported.

The air pressure within the cushion is provided by 4 blower units which are placed on a platform, 10 metres beside the roof structure. 2 large ducts connect the cushion and the blowers, 2 of which run by electricity, the others are Diesel-powered. Only one of the 4 blowers is sufficient to run the system, the others act as emergency units. The air pressure within the cushion is controlled by a central unit. The nominal internal pressure is 0.4 kN/m<sup>2</sup>. If the outside temperature goes below 10° C, defined as the limit for the possibility of snow fall, the pressure will be raised upto 0.55 kN/m<sup>2</sup> automatically. Further manual pressure regulation is possible in case of excessive even higher snow loads.

The annual erection/dismantling which normally is done within a period of 3 weeks, can be split up into the following main steps:

- installation of each second of the 30 columns with the hydraulic lifting units on top already installed;
- lifting of the entire steel ring which had been preassembled on ground. Together with the lifting units on top the columns now act as cranes;
- installation of the remaining 15 columns;
- Placement of the 30 outriggers which are necessary for the lifting of the membrane cushion;
- in the arena: assembly of the cable net, unfolding of the lower and the upper membrane;
- installation of the garland cables;
- the cushion which still lies partially folded in the central area, is attached now to the outriggers;
- lifting up of the entire roof and inflation of the cushion;
- dismantling of the outriggers;
- installation of the facade;
- installation of the heating and the all-electric and scenic equipment.

Out of all these activities the lifting of the complete steel ring, as well as the lifting of the entire roof, are the two most important steps:

The lifting of the ring is done with 0.6 inch strands which are connecting the ring and the hydraulic units at the top of the columns. The hydraulic units are pulling up the ring in small intervals. They all have the same stroke and are all connected to the same pressure pipe system. This guarantees perfect symmetry during the ring lifting.

The lifting of the entire cushion, including the cable net, is the second important and critical phase, because it includes a period where the entire cushion is lifted and floating in the air without being stabilized by its internal pressure. The 4,000 squaremetre membrane acts a large sail if it would be attacked in this situation by heavy wind loads. The lifting procedure therefore is depending from a good weather situation. On the other hand, this lifting, including the attachment of the cushion to the ring and the inflation of the cushion itself, is done within a period of only 5 hours, which is short enough to be safely covered by a weather forecast.



For lifting the membrane cushion, the 30 outriggers, hinged to the column bases, are pulled upwards by the same lifting units at the columns tops by 0.6 inch strands again. While lifting the outriggers turn upwards and thereby take the cushion off the ground into the air. In their final position the top of the outrigger meets the ring node. The cushion then has to be fixed only to the ring. Here again the hydraulic lifting system guarantees a synchronous lifting. This is of utmost importance, because at this time the ring beam is not yet stabilized by the cushion, but already loaded by the erection forces. The lifting itself needs about 2 hours only, with additional 2 hours to attach the cushion to the ring. The inflation of the cushion is done within less than 1 hour.

Since all structural details have been carefully designed for this annual "moving" process and because a special simple, but nevertheless effective equipment had been designed especially for this roof structure in Nimes, a fast and therefore economical and safe erection could be achieved as the experience of the last 3 years proves.

### 3. ROOF FOR THE ARENA IN ZARAGOZA

The existing old arena had been erected at the end of the 18th century in the centre of Zaragoza itself. Until now the arena had been used only for bull-fights during a few days of the year. Then the owner of the arena, the City of Zaragoza, decided to convert the arena into a multi-functional hall for concerts, music festivals and all other type of sports events. This meant for the new roof:

- since the roof is to rest on the old three-storey structure, it should be as light as possible in order not to overload the old masonry.
- only a roof covering and protecting the whole arena, can guarantee the performance of a concert or other musical event.
- for bull-fights, which also will take place in future in this arena, the interior part should be kept open and only the area of the grandstands could be covered by a roof.

The new roof is circular in plan with an outer diameter of 82.7 metres. The outer ring with a width of 23.35 metres, covering the spectators' area, is a permanent membrane structure, supported by a primary cable system. The inner circular part of 36 metres diameter can be covered by a retractable membrane. This layout fulfils all the above mentioned requirements.

The primary structure for the outer permanent roof consists of an outer steel box compression ring, 800 x 500 mm, filled with concrete, 64 lower radial cables, attached to a lower inner ring cable, 32 upper radial cables, attached to an upper ring cable, and 16 tubular steel columns, securing the distance between the upper and lower ring cable. The membrane itself is placed inbetween the lower radial cables, is anchored to the lower inner ring cable and stressed and fixed to the outer steel ring directly. The cable/steel structure is stable in itself without the membrane and is prestressed to such a level that under maximum downward forces - 0.5 kN/m<sup>2</sup> snow load plus wind pressure - which mainly load the lower cables, the upper cable system doesn't get slack.

The retractable-inner membrane roof also needs a primary structure, which is shaped similarly to the outer cable system: 16 upper and 16 lower radial cables, all starting from the inner ring cables, where attached to the 6 m long steel columns, lead to one common central fixed node. Its counterpart, the movable node, is placed below and forms the peak of the "Chinese head"-shaped inner membrane roof. The two node parts are connected by an electrically driven screw jack.

The membrane is suspended from the lower radial cables by sliding carriages at a distance of about 2 metres, so they can move along these cables from the inner "open" position to the stretched "closed" position towards the lower ring cable. When arriving there, the front car-

riage is guided into its exact final position, where it is locked by a pneumatically moved pin. After the membrane has been docked at all 16 outer anchorage points, the central movable node is lifted by the screw jack by about 70 cm and thus the whole inner membrane roof gets its final prestress. All individual steps of the moving anchoring and stressing procedure are monitored and controlled by one central board and can also be influenced/corrected from here when operated manually. Normally the roof opens or closes simply by pushing a button, that means completely automatically.

The distance between the inner ring cable of the permanent roof and the garland cables of the retractable membrane roof, is closed by a wide translucent rain gutter, made of plexi glass. This gutter is dewatered at 4 points by pumps towards the outer main drainage system.

## REFERENCES

- [1.] LAINEY, L., MORIN, N., SCHLAICH, J., BERGERMANN, R.:  
Retractable Roof Olympic Stadium Montreal. IABSE/IVBH Prereport 13th Congress Helsinki, June 6 - 10, 1988.

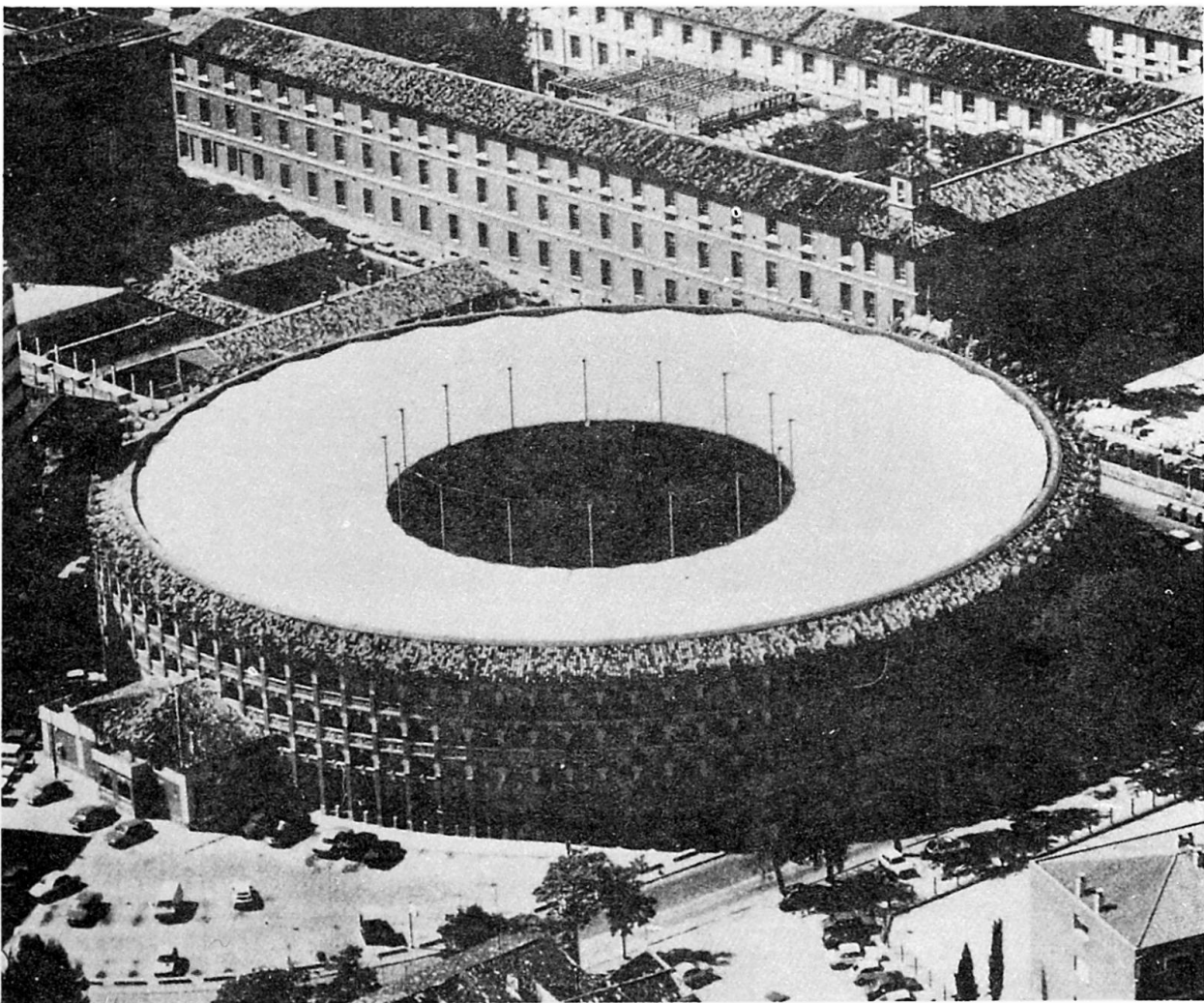
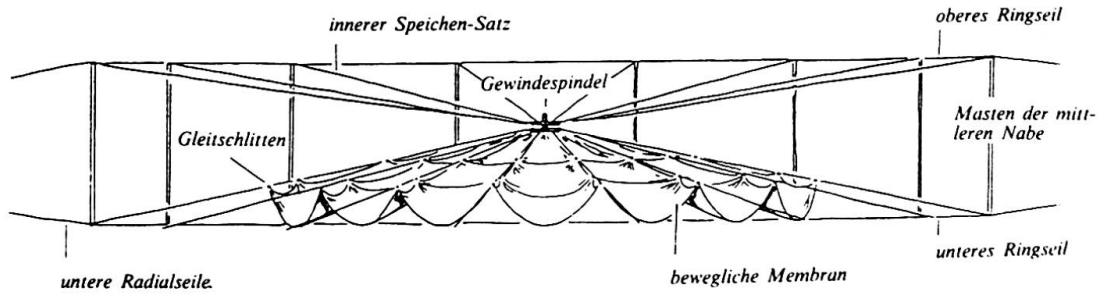
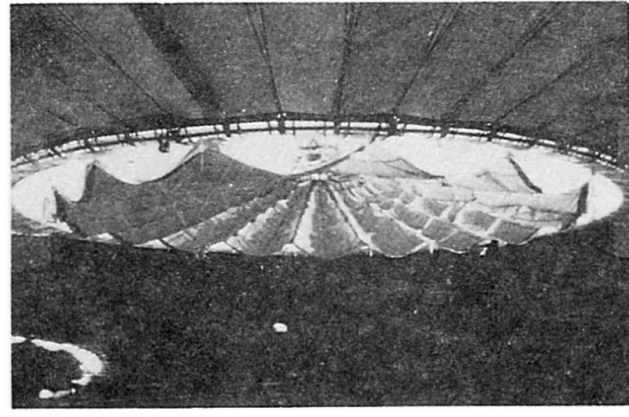
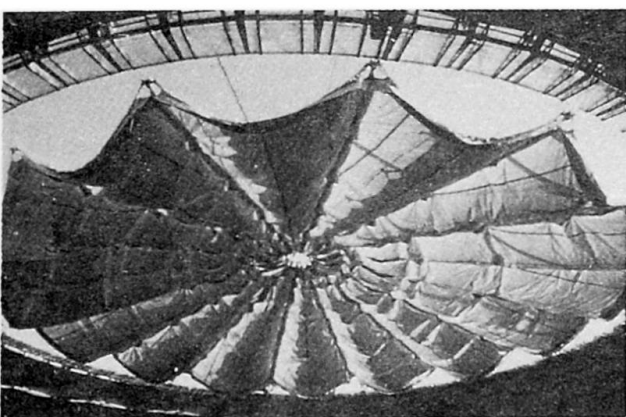
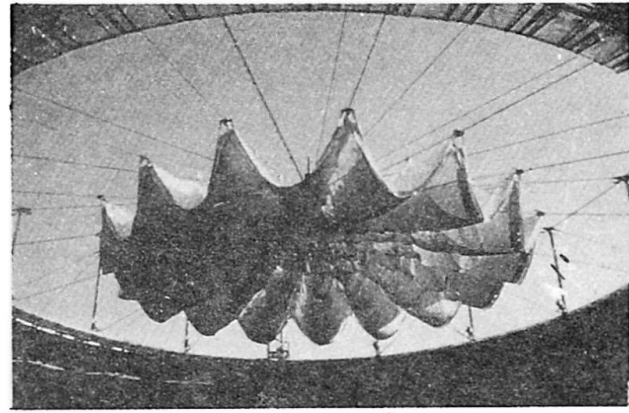
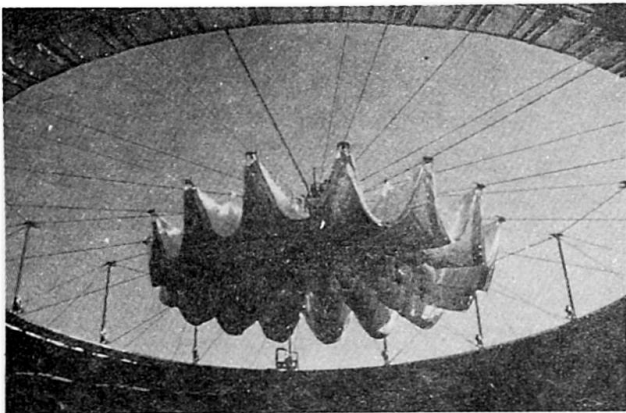
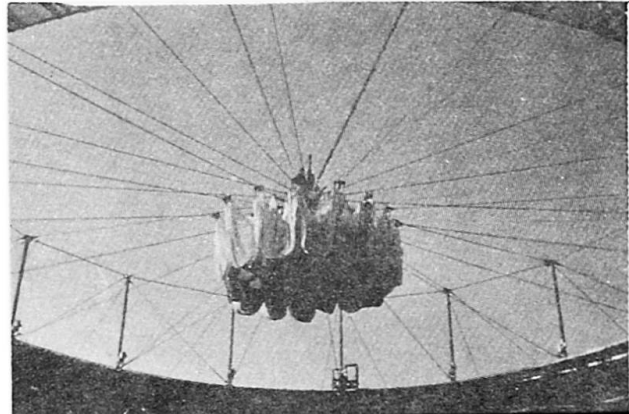
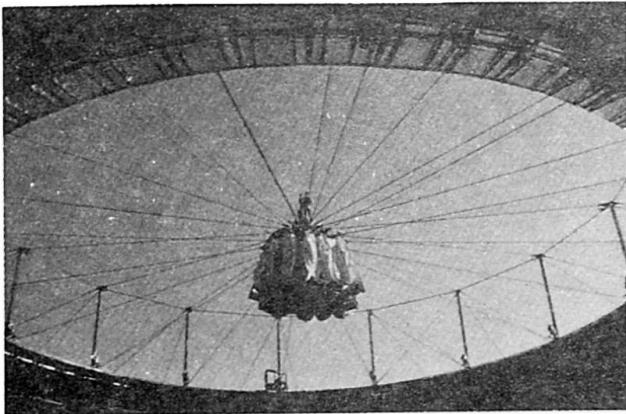


Fig. 13 Arena Zaragoza  
Top view of the old arena with the permanent membrane roof.



**Fig. 14** Arena Zaragoza  
Concept of the retractable inner membrane roof.



**Fig. 15** Arena Zaragoza  
Opening/closing procedure of the 1 000 m<sup>2</sup> inner membrane roof.

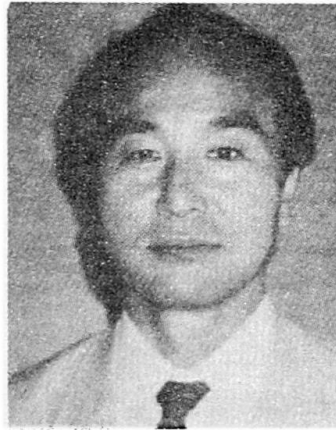
## Design and Construction of Green Dome Maebashi

Conception et construction du stade "Green Dome Maebashi"

Planung und Konstruktion des Green Dome Maebashi — Stadions



**Hiroh TOMINAGA**  
Manager  
Shimizu Corp.  
Tokyo, Japan



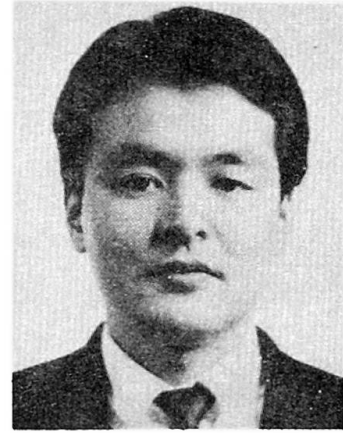
**Masao SAITOH**  
Prof. Dr.  
Nihon Univ.  
Tokyo, Japan



**Hajime NAKAJIMA**  
Structural Eng.  
Shimizu Corp.  
Tokyo, Japan



**Tshiyuki YAMADA**  
Deputy Manager  
Shimizu Corp.  
Tokyo, Japan



**Takayuki NISHIYA**  
Structural Eng.  
Shimizu Corp.  
Tokyo, Japan

### SUMMARY

This paper describes structural design and construction practice of the Dome. In the design, computer simulation was conducted to study the method and procedure of construction. During its construction, stresses and deformations of the roof structure were measured.

### RÉSUMÉ

Cette communication décrit la conception structurale et les travaux de construction de la coupole. La simulation sur ordinateur a été exécutée en vue d'étudier la méthode et les étapes de construction. Pendant la mise en œuvre, les contraintes et déformations de la couverture ont été mesurées sur place.

### ZUSAMMENFASSUNG

Diese Abhandlung beschreibt den Entwurf und die Konstruktion des Stadion. Die Bauverfahren wurden während der Entwurfsphase anhand von Computer-Simulation untersucht. Die Beanspruchungen und Verformungen, die auf die Dachstruktur wirken, wurden während des Bauvorgangs vor Ort gemessen.



1. INTRODUCTION

The roof of Green Dome Maebashi has an oval type of Beam String Structure (BSS) in which the parallel type of BSS and the radial type of BSS are connected to the rigid center ring girder. This shallow domed roof, in addition, has concentric half circles of arched sub beams and horizontal braces for ensuring its stretching rigidity.

The structural design of the roof is based on the principle that the dead load should be carried by the main members of the roof while the load due to earthquake, wind, snow and temperature are handled by the secondary members such as sub beams and braces as well as the main members. During construction, when cables are prestressed after the completion of the erection of roof steel, stress will act in all beams, sub beams and braces because of the effect of dome action. For this reason, as study of the planning of steel work and finish work, the computer simulation of the processes of the construction was done in order to establish good methods and procedures for erection of steel and for prestressing. After the construction commenced, the stresses and the deformations of beams were measured to investigate whether or not the behavior of the huge roof during the construction works agrees with the data resulting from the above analysis. This paper describes such structural design, planning of construction work and the behavior of the roof structure during construction.

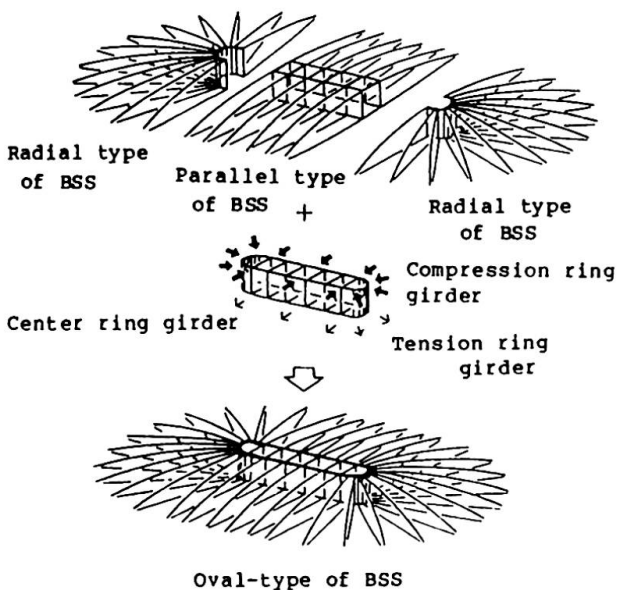
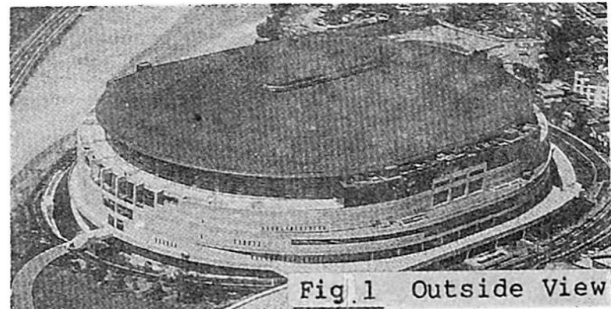
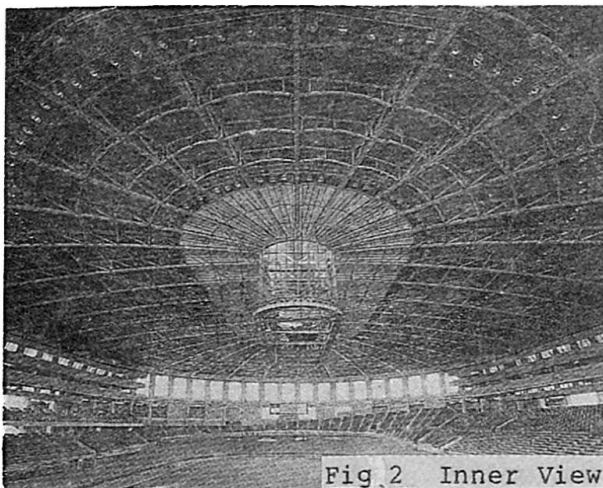


Fig. 3 Structural System

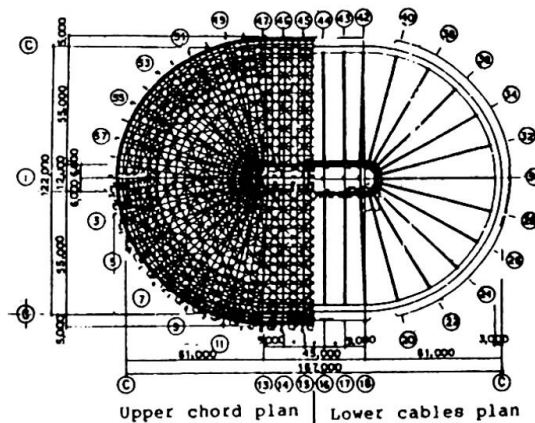


Fig. 4 Roof Framing Plan

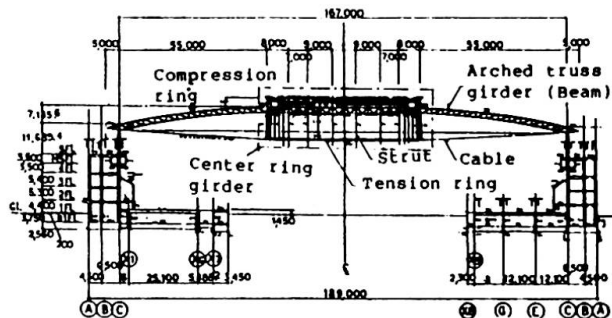


Fig. 5 Longitudinal Section



## 2. OUTLINE OF THE BUILDING

This building is composed of the huge roof with the oval-type Beam String Structure (167 m by 122 m) and the 6 layers stand with the steel-framed reinforced concrete structure which supports the roof. The roof area is approximately 20,000 m<sup>2</sup>, and the use of BSS realized the shallow oval dome with 0.057 rise/span ratio. One of the mechanical characteristic of BSS is the no existence of the horizontal thrust due to the dead load of the roof. Therefore, the roof structure can be supported simply by peripheral structure with large opening formed under the eaves.

The oval-shaped roof is composed of the parallel type of BSS and the radial type of BSS. These are connected by rigid center ring girders. Each BSS is composed of a beam, strut and cables. The beam is a 2.5 m deep arched parallel truss with H shape steel (series 400), the strut is a steel pipe (267 in diameter) and the cables are two spiral ropes (84 in diameter for parallel part and 74 in diameter for radial part). The roof is finished by the copper roofing with autoclaved light weight concrete (ALC) panel. The dead load specified by the design of the roof is 2400 N/m<sup>2</sup> as the uniform load.

## 3. STRUCTURAL DESIGN

A mechanical characteristic of BSS is the control of the stress distribution and deformation of beams by tensioning the cables. Therefore, the most important points of the structural design for BSS are specifying the shape of BSS and the optimum prestressing force for their cables.

## 4. PRELIMINARY EXAMINATION OF CONSTRUCTION WORK

Prior to the construction work of BSS, it is necessary to make examinations for deciding how much tension should be applied, when the tension application should be carried out and how it will affect the entire schedule of construction works. The examinations was proceeded using a computer simulation of the construction procedure. The basic data for planning the construction work, especially the procedures for the election of steel was proposed. From now on, the optimum prestressing force and the relation between construction procedure and prestressing force will be described.

### 4.1 Calculation of Optimum Prestressing Force

The load which affects the building most is considered to be its dead load. Therefore, at first the optimum prestressing force was specified realizing the minimum deflection and stress of beams.

The deformation and the stress of point, are defined by the following equations:

$$\delta_i = \alpha_{iw} \cdot W + \alpha_{iA} \cdot T_A + \alpha_{iB} \cdot T_B \quad (i=1,2) \quad (1)$$

$$S_i = \beta_{iw} \cdot W + \beta_{iA} \cdot T_A + \beta_{iB} \cdot T_B \quad (i=1\sim 4) \quad (2)$$

where, W is dead load, T is tensile force of cables (T<sub>A</sub>: for Parallel part, T<sub>B</sub>: for Radial part), and  $\alpha$ ,  $\beta$  are influent factors for their loads. Considering the deformation of the center ring girders and the stress distribution in the beams, the optimum prestressing forces are obtained in the case of the presence of secondary members and in that of the absence of secondary members, as shown in Table 1.

### 4.2 Procedure of BSS Construction

For the construction work of BSS requiring the application of prestressing force, it is necessary to examine such points as:

(1) the time for prestressing, (2) the level of the load for applied prestressing force, (3) the number of jacks and the capacity of each jack for





prestressing, (4) the influence of the restriction of the secondary members and (5) the rigidity of temporary supports. The proposed procedure of the construction work of BSS will be process a and b shown in Fig.7.

In process a, the cables are prestressed after the completion of steel work and finish work. In process b, the cables are prestressed just after the election of steel, and then additional tension force is applied to them by finishing weight.

4.3 Computer Simulation for the Procedure of the Construction Work

The numerical analysis was executed by using five analysis cases whose parameters are a construction procedure, the restriction of secondary members and an optimum prestressing force (Table 2). The result of the simulation for the final stage of construction work is shown in Fig. 8. The deformation, the stress in the beams, the axial force in the sub beams and the axial force in the braces in case d match the result of the simulation in case b2.

The only disadvantage in case b1 is the restriction of the secondary members due to the large deformation of the roof. This disadvantage can be eliminated by adopting the roof construction procedure including the slit zone system (case b2), and thus it is possible to ensure the quality specified by the design.

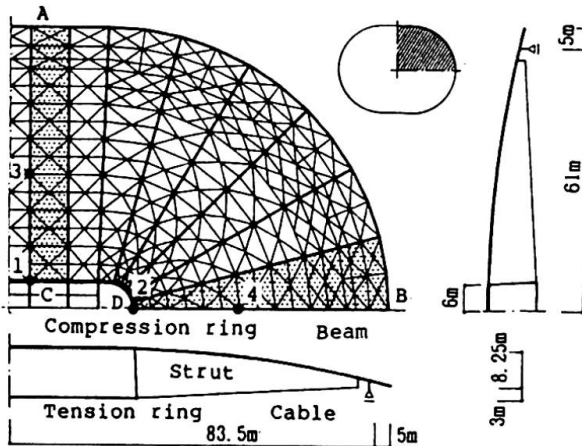
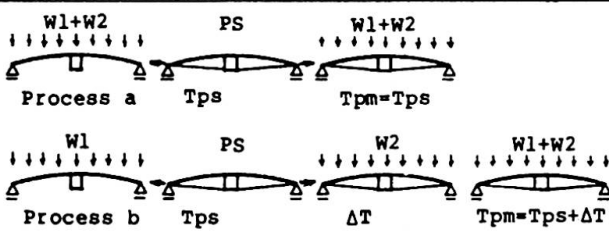


Fig. 6 Analysis Model

Table 1 Optimum Prestressing Force With and Without Secondary Members (kN)

	With Secondary Members	Without Secondary Members
$\delta_1 = \delta_2 = 0$ Equation (1)	$T_A = 3773,$ $T_B = 2372$	$T_A = 3989,$ $T_B = 2940$
$S_1 = S_3,$ $S_2 = S_4$ Equation (2)	$T_A = 3773,$ $T_B = 2391$	$T_A = 3871,$ $T_B = 3273$



w1 : Steel weight w2 : Finish weight  
Tps: Applied prestressing force  
ΔT : Added tension force  
Tpm: Optimum prestressing force

Fig.7 Construction Process

Table 2 Analysis Cases

	d	a1	a2	b1	b2
Construction Process	-	a	a	b	b
Secondary Members	NO	YES	YES	YES	YES*
Tpm (kN)					
Parallel	3773	3920	NON*	3773	3773
Radial	2401	3087		2401	2401

YES\*: According to the construction procedure including the slit zone system.

NON\*: Dome structure without cable.

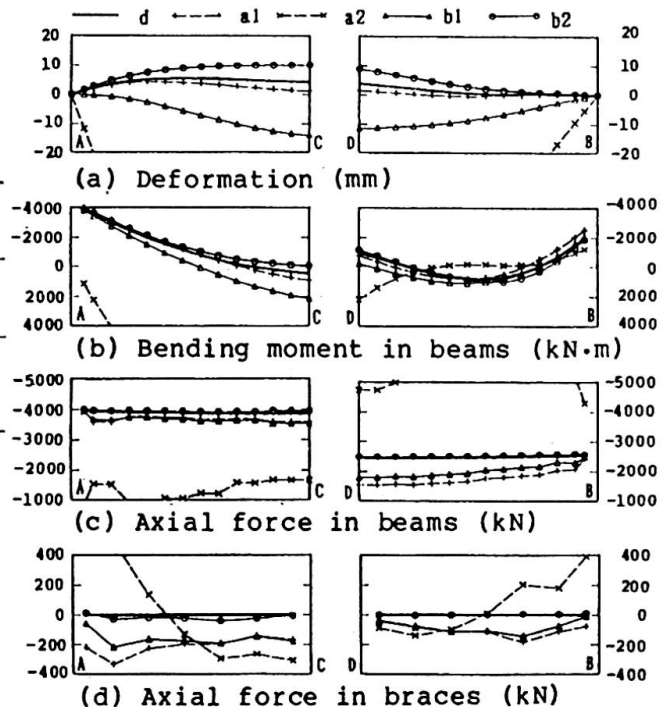


Fig.8 Result of Simulation for the Final Stage of Construction Work (completion)



## 5. CONSTRUCTION PLAN

As for construction of roof steel, the center ring girders are placed on temporary supports, and the truss beam is assembled on the ground and then lifted up. Fastening of 68 cables goes in parallel with the erection of roof steel, and the fastened cables are prestressed just after the completion of roof steel erection.

### 5.1 Prestressing Force Application

Prestressing force is applied to the cables by using 68 center-hole hydraulic jacks to tension all the 68 cables simultaneously. To go into details, the application is conducted by 18 groups using automatic load control device. The load on the hydraulic jacks in the charge of each group is indicated in percentages by a digital load meter in the main control room, the specified prestressing force being as 100%. The specified prestressing force, which measured 1460 to 1480 kN for cables of a parallel part and 902 to 941 kN for cables of a radial part, is applied at steps.

### 5.2 Measurement under Construction

The loads, deformation and stresses were measured in the BSS in order to find out the behavior of the structure in the process of the construction. The measured result and the values resulting from the prediction by the analysis considering the construction procedure will be described from now.

The basic point (zero point) for load measurement by a load cell is that in which no load is applied to the structure, and the basic point (zero point) for deformation and strain measurement is that in which 20% of the total prestressing force is applied. Every application of prestressing force was followed by measurement and examination, which were repeated when necessary, as shown in Fig.9.

## 6. RESULT OF THE MEASUREMENT

### 6.1 Tension of cable

The relation between the processes of construction and tension of cable is shown in Table 3. When prestressing was completed, all the 18 digital load meters indicated 100%. At this time, the actual data obtained with the load cells agreed 99.5 to 103.1% with the data resulting from the analysis. In addition, the vibration method to measure the tension of all the 68 cables was used. Then, the tension was calibrated by using as a standard the actual data obtained with a load cell, and the tension of each cable was calculated. The result was that the errors range from 4.8 to 3.7%. The errors in the measured tension when the ALC application work was completed ranged from 0.7 to 6.7%, and those when the roof construction was completed from 3.6 to 0.6%, so the actual data agreed well with the data resulting from the prediction.

### 6.2 Tension of cable, deformation and stress

The vertical deformation of the compression ring increases greatly in harmony with its predicted values once the roof parts from the supports. Then, the deformation begins diminishing because the finish work increases the weight of the roof. The actual data results in good agreement with their predicted values throughout the processes of the roof construction (see Fig.10).

The axial forces in the centers of the beams increase monotonously in the course of the construction processes. Their actual data and predicted values agree well with each other. As for the bending moment, its actual data are smaller than its predicted values after prestressing, but they agree with each other when the roof construction was completed (see Fig.11).

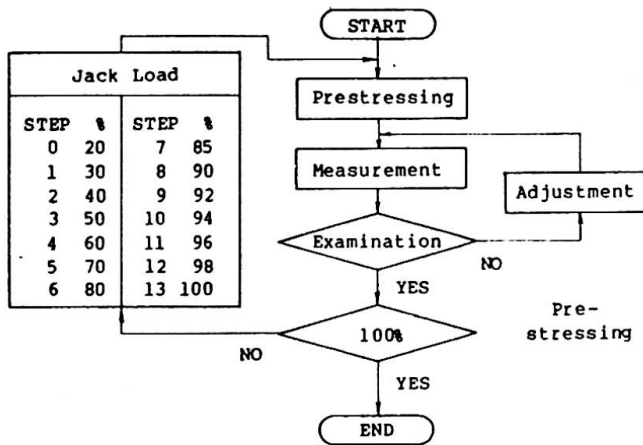


Fig.9 Flowchart of Prestressing and Measurement

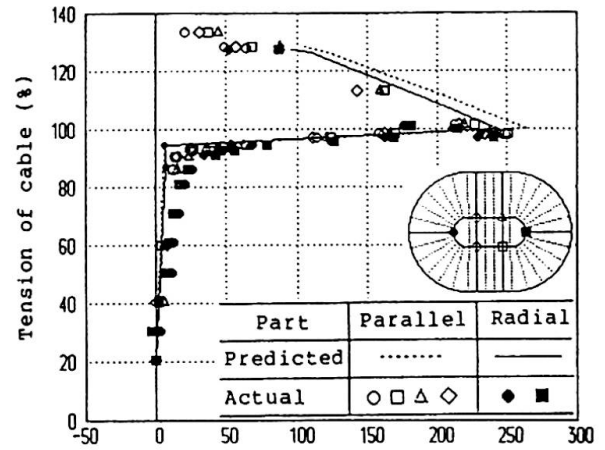


Fig.10 Relationship between Tension of Cable and Vertical Deformation of Cable and Vertical Deformation

Table 3 Construction Processes and Tension of Cables (kN per cable)

Construction Process		Location					
		1	7	11	13	14	46
After pre-stressing	Actual (by load cell)	951 936	954 959	921 917	1498 1484	1482 1512	1497 1480
	Actual (by vibration method)	1026 999	999 1026	972 972	1618 1579	1576 1616	1616 1616
	Predicted	941	931	902	1480	1470	1470
After ALC work	Actual (by load cell)	1201 1198	1232 1240	1242 1249	1948 1930	1949 1983	1968 1951
	Predicted	1189	1187	1181	1876	1844	1844
Completion	Actual (by load cell)	1160 1157	1189 1195	1189 1195	1872 1851	1862 1897	1882 1897
	Predicted	1201	1201	1201	1887	1887	1887

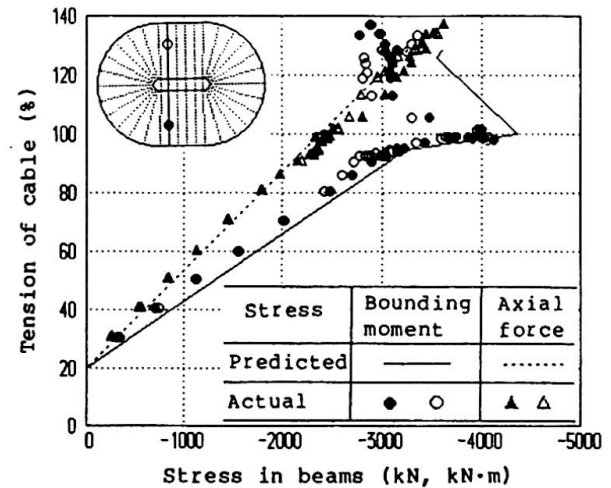


Fig.11 Relationship between Tension of Cable and Stress in Beams

7. CONCLUSION

The design and construction of Green Dome Maebashi has been described so far. The description will confirm the following points:

- (1) The actual data on such points as deformation and stress agreed well with their predicted values.
- (2) Simultaneous prestressing proved to be reliable and effective.
- (3) As it had been expected, the additional tension of the cables acted as finish work advanced. And the ultimate tension agreed well with the specified value (optimum tension).
- (4) The roof construction procedure including the slit zone system proved to be effective for the countermeasure of the restriction of secondary members during prestressing and finish work.

From the above, it may be concluded that the method of prediction and the construction work of prestressing are worthwhile.

REFERENCE

Saitoh, M., "Beam String Structures", 1989 Madrid IASS Congress  
 Tominaga, H., "Design and Construction of Green Dome Maebashi", 1991 Copenhagen IASS Symposium

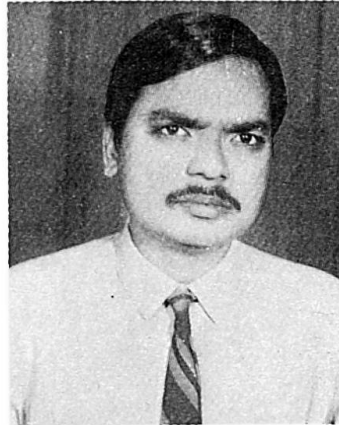
## Prestressed Steel Structure for Large Span Industrial Buildings

Structures métalliques précontraintes dans les ouvrages industriels

Vorgespannte Stahlkonstruktionen im Industriebau

### Laxmikant M. GUPTA

Assist. Prof.  
Nagpur VRCE, India



L.M. Gupta born in 1959 received his Civil Eng. degree in 1980. M.Tech. Structural Eng. 1983 from Nagpur University. Worked as Junior Engineer for 9 years in Maharashtra State Electricity Board. Now working as Assist. Professor in Dep. of Applied Mechanics, VRCE Nagpur.

### SUMMARY

In large span industrial buildings the load bearing capacity of a member mainly depends upon its self weight, which involves a large quantity of steel required for construction. Nowadays structural steel is one of the costliest items. Thus maximum economy in use of steel is a must. Prestressing steel structures enhances the efficiency of the structure before the structure is put to its actual use. A saving of 37% in cost is obtained by using a prestressed steel structure over a conventional structure.

### RÉSUMÉ

Dans les constructions industrielles de grande portée, la surcharge des éléments porteurs dépend largement de leur poids propre, d'où l'obligation de prévoir un gros tonnage d'acier dans l'ouvrage à réaliser. Etant donné que, de nos jours, l'acier représente le facteur essentiel influant sur les coûts, l'économie en poids de ce matériau est de rigueur. La précontrainte des structures porteuses en acier permet d'augmenter le degré d'utilisation des constructions et, de la sorte, de réaliser un gain de 37% des coûts par rapport aux constructions métalliques traditionnelles.

### ZUSAMMENFASSUNG

Bei grossen Spannweiten im Industriebau hängt die Nutzlast der Tragkonstruktion stark von deren Eigengewicht ab. Da Baustahl heutzutage einen Hauptkostenfaktor darstellt, ist äusserste Sparsamkeit unabdingbar. Die Vorspannung von Stahlkonstruktionen erhöht den Ausnutzungsgrad und spart etwa 37% Kosten gegenüber dem konventionellen Stahlbau.



## 1. INTRODUCTION

1.0.1 Design example presented here is of a frame of large span industrial building (as shown in Fig. No.1). Building having a span of 39.0 m and height of 29.155 m and length 200 meters.

Roof consists of precast R.C.C. slab with screed concrete and .7 layers of tarfelt. The sides are covered with siporex slabs. Brackets at 22.207 m Support gantry girder the capacity of crane is 1000/200 KN. Present frame of industrial building is made up of welded plate girder. It is compared with open web section/hollow section of mild steel and high tensile steel

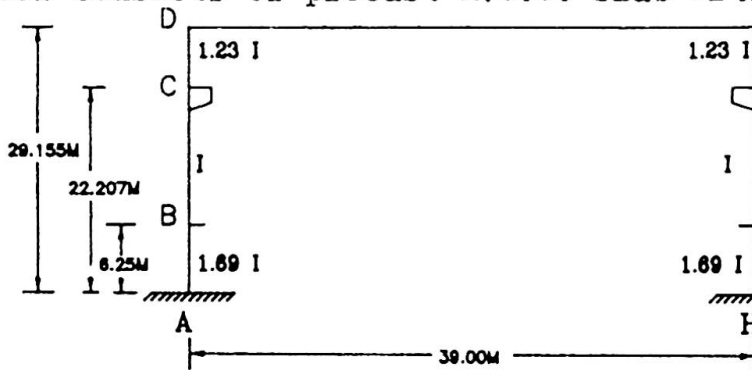


FIG. No 1.

without and with prestressing. It is seen that considerable saving is obtained by using open web section/hollow section of HT steel with prestressing.

## 2.0 ANALYSIS

2.0.1 Frame was analysed in detail with the help of column analogy and moment distribution method for all types of loads to which it will be subjected i) Deadload ii) Liveload iii) Crane load iv) Wind load v) Earthquake vi) Blast load. After calculating the joint moment various load combinations were adopted and it was found that maximum moment is developed in frame is as follows.

- (a) Beam - Deadload + Liveload + Crane to the right
- (b) Column - Deadload + Liveload + Crane to the right + Windload (R to L)

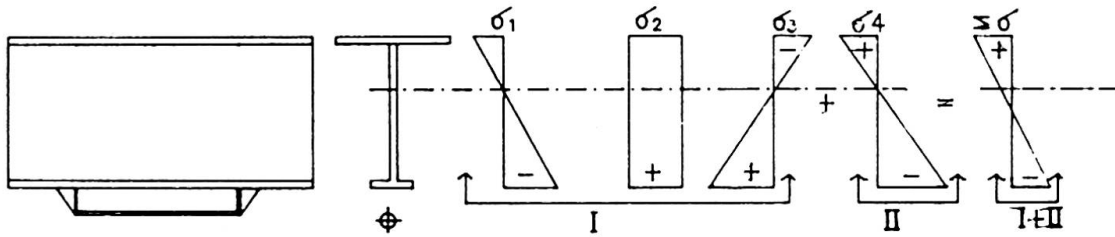
## 3.0 DEVELOPMENT OF THEORY

### 3.1 Prestressing in Steel Structure

3.1.1 Principal concept of prestressing is to provide stress of opposite sign to that from the design load in the structure. This is achieved by the initial application of calculated external force whose magnitude and direction are worked out. Considering beam as shown in Fig. No.2. Tendon is placed externally below the beam cross section on tension side. Behaviour of beam at the cross section of maximum bending moment may understood by considering two stages as indicated vide Fig. No. 2.

Maximum prestressing force can be calculated as  $P = \frac{R A \phi Z}{Z + eA}$

$$\text{Self stressing force } P = \frac{\frac{M_1}{I_{xx}} w}{\left[ \frac{M_1^2}{I_{xx}} + \frac{1}{mA_{td}} + \frac{1}{A} \right] l_{td}}$$



STAGE - I - FROM DEAD LOAD + PRESTRESSING

STAGE- II - FROM LIVE LOAD INCLUDING IMPACT

FIG No.2

Deflection due to prestressing is calculated from the formula

$$\delta_p = \frac{peA^2}{3EL} [1 - 4(a/L)^2]$$

where;

a = Distance between bearing to tendon;

A = Area of c/s of beam

$A_{td}$  = Area of tendon;

e = Distance between centre of tendon to centre of beam c/s

L = Length of beam;

m = Modular ratio;

$M_1 = 1 \times e$

P = Prestressing force;

w = Area of diagram of bending moment due to all loads on the tendon length ;

Z = Section modulus of beam fibres in compression;

$\delta_p$  = Deflection due to prestressing

$\phi$  = Coefficient of buckling.

#### 4. DESIGN

Frame is designed by using different type of section/materials such as

1. Using Solid web section of M.S.
2. Using Open web section/hollow section of M.S.
3. Using open web section/hollow section of H.T. steel
4. Using Open web section/hollow section of M.S. with prestressing
5. Using Open web section/hollow section of H.T. steel with prestressing

4.0.1 Present frame which has been provided are not utilised to their capacity. So an attempt was made to reduce the section. A design was also carried out by using open web section for beam and hollow section for column of mild steel as well as high tensile steel without and with prestressing. It is observed that considerable reduction in cost is obtained by using open web section/hollow section of H.T. steel with prestressing. The typical section adopted is as shown in Fig. No. 3.

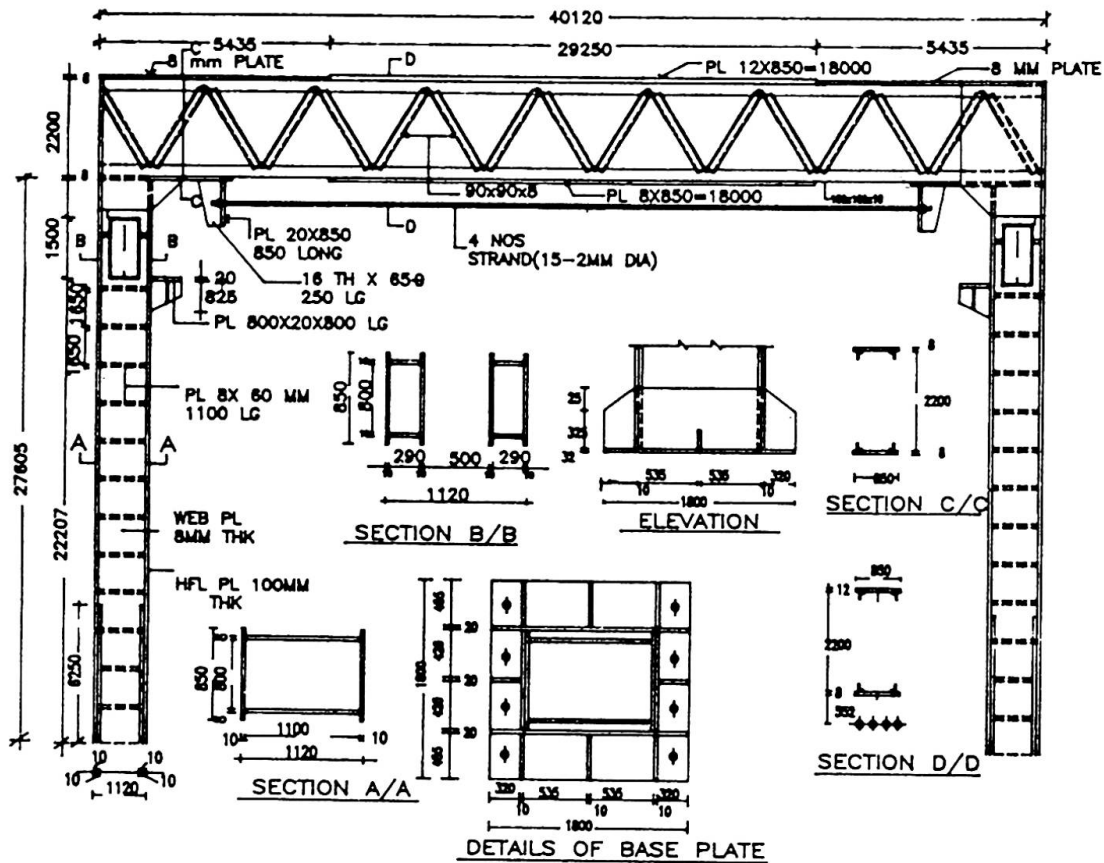


FIG. NO. 3

## 5. COST CALCULATION AND COMPARISON

5.0.1 Based on design prepared for frame, Estimate of quantity and cost of construction is calculated and compared (as shown in table No. 1). It is seen that a saving of 37.2% in cost has been obtained by using open web section/hollow section of H.T. steel with prestressing as compared to conventional type of structure.

Sr. No.	Particulars	Total Cost (In Rs.)	Saving in Rs.	% Saving
1.	Structure provided at site	822952.19	-	
2.	Using solid web section	696254.48	126697.71	15.39
3.	Open web section/ Hollow section of M.S.	595037.44	227914.75	27.69
4.	Open web section/ Hollow section of H.T.	533079.59	289872.60	35.22
5.	Open web section/Hollow section of M.S. with prestressing.	557040.98	265911.21	32.23
6.	Open web section/Hollow section of HT with pre- stressing.	516803.55	306148.64	37.20

Table - 1

## 6. EXPERIMENTAL WORK - MODEL STUDIES

6.C.1 To verify the theory developed and computational result obtained, a structural model of smaller dimension was fabricated to test credibility and feasibility of this kind of study. After study it was possible to find out problem with model and resolve them to obtain finally comparable results with the prototype.

Details of model are as follows :-

1. Scale ratio =  $\frac{1}{10}$  ; 2. Stiffness of ratio = Stiffness ratio of model member of prototype
3. Size of beam - 200x100 mm, column - 170x100 mm
4. Open web sections made up of angle and bar were used for beam and column
5. Prestressing wire - 4 mm

Complete view of model is as shown in photograph No. 1.

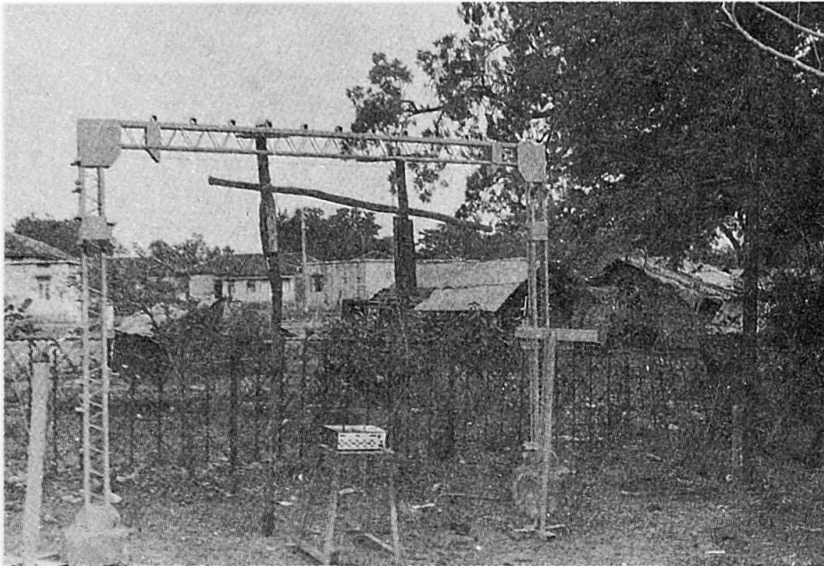


PHOTO - 1.

b) Under load condition :- Model was loaded fully by hanging

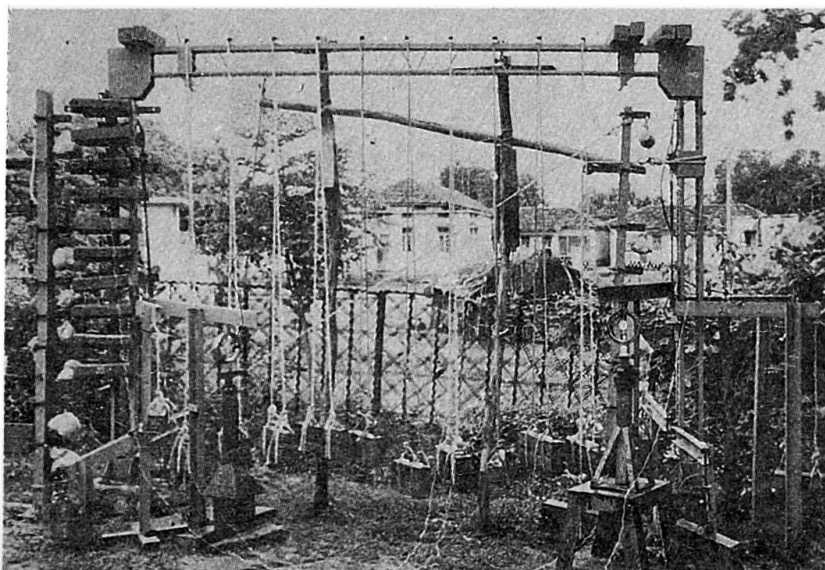


PHOTO - 2.

For obtaining comparable results, model was tested for same load condition as in prototype

a) Under No load condition:- Beam was prestressed for 800, 1050, 1400 kg force. Deflection under various locations was measured.

weights, applying load by screw jack at different places as shown in photograph No.2. Experimental results obtained were verified for symmetry and reciprocity. They are found to be comparable with conventional results.





## 7. DISCUSSION AND CONCLUSION

7.0.1 Experimental verification gives the reliability of using prestressed steel structure. Theory developed can be effectively used for studying the behaviour of prestressed steel structure. This structure will definitely reduce the overall cost of project. Following optimum parameters were decided for design of a prestressed steel structure.

1. Eccentricity -  $\frac{e_y}{r_x^2} > 1$  ;
2. Length/depth ratio  $\leq 20$       3. Unsymmetrical parameter ;  
 $\frac{y_1}{y_2} = 1.7$  to 2.0.      4. Optimum length of tendon = (0.7 to .75)L
5. Elevation of tendon  $t = 1.05$  to 1.20.

## ACKNOWLEDGEMENT

Author acknowledges with thanks encouragement given by Dr.M.M. Basole, Head of Deptt. of Applied Mechanics and Dr.G.N. Garud, Principal, Visvesvaraya Reg. College of Engg., Nagpur, in completing this work.

## REFERENCES

1. Belenya E. 'Prestressed load bearing metal structures', Mir Publishers, Moscow.
2. Vazirani and Ratwani - Analysis of Steel Structure Vol. 11 Khanna Publishers, N. Delhi.
3. IS 800-1984 Indian Standard Code of Practice for General construction in steel.
4. IS 875-1964 Indian Standard Code of Practice for Structural Safety of Building.
5. Gupta L.M. and Basole M.M. - Use of prestressed steel structure proceeding of Twin Conference on Project Management and Concrete steel structure, Madras - 1985 p.15-1, 15-2.
6. Gupta L.M. and Basole M.M. - Optimisation of turbine structure for 210 MW and 500 MW capacity sets in thermal power station - Proceedings of International Conference on Steel Structures and Space frame. C.I. Premier Pvt. Ltd., Singapore - Feb. 1990 p. 83-88.
7. Gupta L.M. - Optimisation of turbine house structure for 210 MW and 500 MW capacity sets in thermal power station. Ph.D. Thesis submitted to Nagpur University, 1990.

----

## Dry Dock with Anchored Bottom

Cale sèche à radier ancré

Trockendock mit verankerter Bodenplatte

**Romeo CIORTAN**  
Assoc. Prof.  
Design Inst. for Transport  
Bucharest, Romania



Romeo Ciortan, born 1941, received his civil engineering degree at the Civil Engineering Institute Bucharest-Romania. He was involved in special problems for hydrotechnical construction. Now he is responsible for the design of port construction development, coastal engineering and shipyards.

### SUMMARY

In order to obtain a dry dock of great dimensions in Romania, for the foundation slab a solution for anchoring into the foundation rock has been applied by using an original tie-bar allowing a favourable distribution of forces into the bulb, thus reducing the tension members by comparison with classical solutions

### RÉSUMÉ

Pour la réalisation d'une cale sèche de grande dimension en Roumanie, on a choisi la solution d'ancrage dans la roche de fondation, utilisant un type original de tirant qui permet une distribution favorable des efforts dans le bulbe, réduisant ainsi la valeur des contraintes par comparaison aux solutions classiques.

### ZUSAMMENFASSUNG

Für den Bau eines grossen Trockendocks in Rumänien wurde die Lösung gewählt, die Grundplatte in den darunter liegenden Felsen zu verankern. Dazu dienen besondere Zugstangen mit verbreiteter Fussverpresszone, die eine günstige Krafteinleitung erlaubt. Dadurch sinkt das Spannungsniveau gegenüber einer herkömmlichen Lösung.



### 1. GENERAL

Within Mangalia shipyard located on the Romanian shore of the Black Sea, a dry dock has been built for ship repair up to 250000 dwt (fig.1)

The foundation ground is rocky, being very heterogenous the rock being compacts resistant, with different densities from soft and friable with pseudohorizontal and with variable and less permeability on the vertical. At a depth about 22.0 m we may find a layer with reduced permeability, 2 m thick.

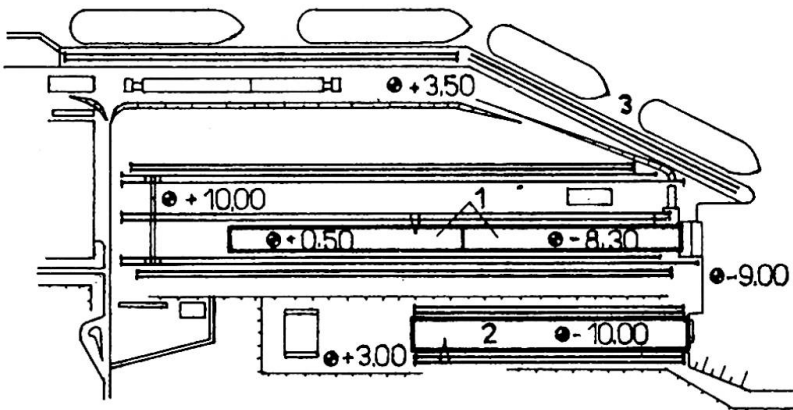


Fig.1 Dry dock in Mangalia shipyard-Romania  
1,2-existing dry dock; 3-new repair dry dock

### 2. THE CONSTRUCTIVE SOLUTION OF THE DRY DOCK

In cross section, the dock is made up of an anchored bottom plate 1.80 m thick and of two lock walls 2.75 m thick and 13 m high with a cantilever towards the filling for the balance of the bending moments into the bottom plate (fig.2).

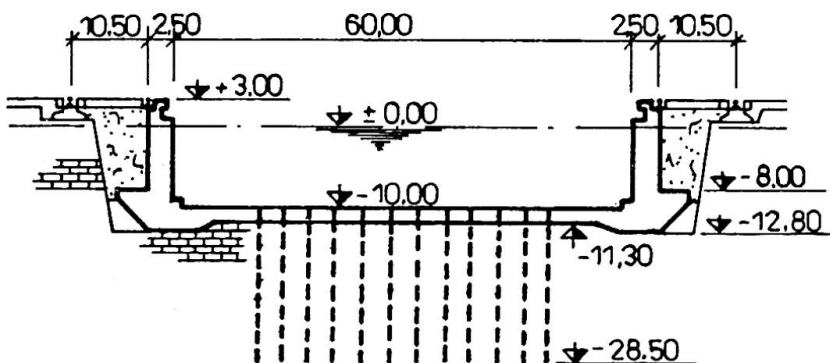


Fig.2 Repair dry dock

To adopt a classical solution a gravity one would have led to a slab thickness of 7.80 m in order to undertake the water pressure. By excavating the enclosure up to -18.0 m the rock bottom plate would have had a lesser thickness above the half-permeable layer existing the peril to loose its stability under the effect of underpressures. That would have led to considerable increase of in flows into the enclosure with an imprevisibile evolution by moving the material from the rock holes. In order to avoid that

situation we must make a screen in order to waterproof at -30.0 m, which costs very much. In the end was adopted the solution of interlocking with the foundation rock, using pretensioned tie-bars.

The rock between the bottom plate and the anchoring of tie-bars constitutes a ballast in order to undertake the underpressure of water, this, the foundation platform thickness has been reduced to 1.80 m.

### 3. TIE-BARS MAKING UP

The tie-bars have been made up of 48 wires  $\varnothing 7$  mm used for prestressed concrete, with a resistance of 16,000 daN/sq cm disposed in an optimum network with a side of 3.50 m, this resulting 1224 pieces.

The calculation charge for a tie-bar is of 1450 KN, determined by the condition that the joint between the bottom plate and the rock should be maintained as compressed in all calculation hypotheses.

The tie-bar is 17.30 m long and comprises an anchoring bulb of 6.0 m the free length being of 11.30 m (LI) (fig.3). The anticorrosive protection has been obtained by means of wires into the cement concrete on the bulb area and in a haft fluid solution on the free length everything being introduced into a sheath made up of polyethylene  $\varnothing 110$  mm, the wall being 1 mm thick—closing the bunch. The space between the rock and the sheath has been filled with mortar and cement.

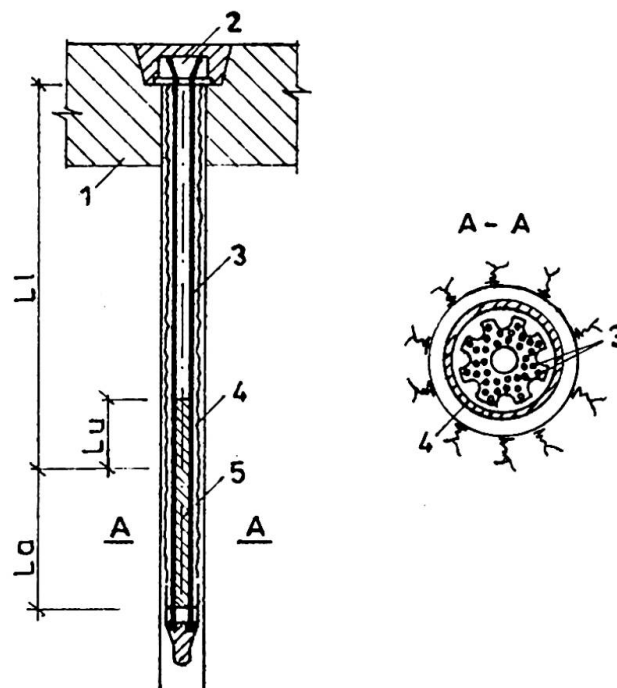


Fig.3 Anchoring cross-bar for the dry dock bottom

1.the dry dock bottom; 2.blocking system; 3.  $\varnothing 7$  mm wires;  
4.striated casing; 5.cement mortar ; Lu-prebulb length;  
La-bulb length



From experiences from similar works the bulb has presented cracks upwards due to the excessive efforts produced by the wire tensioning. In order to eliminish that, the tie-bar has been executed in an original way, using a prebulb 2.80 m lenqht (Lu), upwards of the bulb, having as a characteristic the lock of adherence to the wire. By this constructive measure the prebulb acts like a washer, this contributing to the reduction of the tensioning efforts in the bulb (fiq.4).

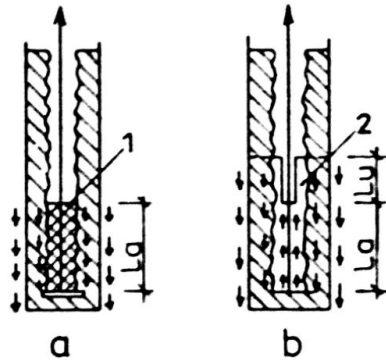


Fig 4. Efficiency of tie-bar with prebulb  
 a. tie-bar without prebulb ; b. tie-bar with prebulb  
 1. area with cracks ; 2. prebulb with a washer effect

4. THEORETIC STUDIES CONCERNING THE EFFORTS IN TIE-BARS AND IN THE ROCK

In order to make in evidence the pre-bulb effect, theoretical studies have been made using programme SAP IV, discretising the tie bar into elements with axial rigidity and respectively symetrically axial calculating the values of efforts in different hypotesses. It has been noticed that in the section immediately downwards to the contact area prebulb-bulb, the maximum tensional vertical effort and the sliding one decreases by about 50% in the variant with pre-bulb (fiq.5)

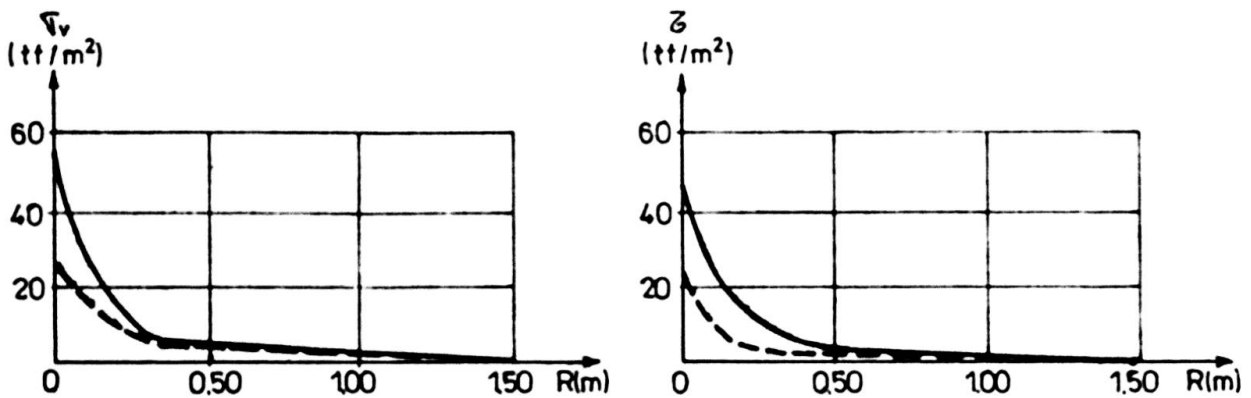


Fig.5 Diagramme of normal and tangential unitary efforts at the level of the contact area between bulb and prebulb  
 ----- tie-bar with prebulb  
 ————— tie-bar without prebulb



In the rock the efforts decrease rapidly that decrease undertaking to a great quota to the loading transmitted to the anchorage (fig.6).

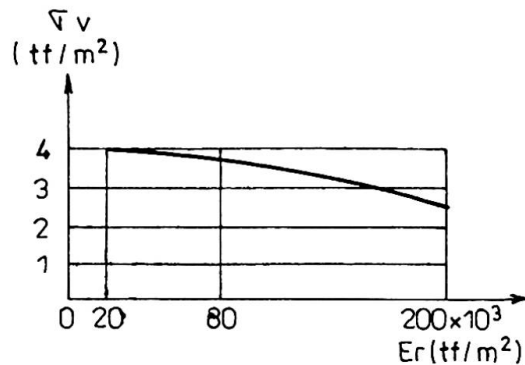


Fig.6-Variation of normal unitary effort  $\bar{v}$  at the contact between rock and tie bar, at the upper side of the bulb, according to the size of the elasticity modulus of the rock  $E_r$

### 5. THE TIE BARS TENSIONING

In order to obtain a good connection between the tie-bars and the rock, the cementing must be carried out in a relatively dry hole. So, the holes  $\varnothing$  150 mm were filled with cement mortar under pressure.

The process of redrilling was carried out at maximum one day before introducing the tie bar.

The tie-bars were introduced into the holes when the concrete resistance to compression of the bulb reached 250 daN/sq.cm.

After reaching a resistance of 280 daN/sq.cm. of the cement mortar of the outer sheath, the tie-bar were pretensioned by means of a hydraulic press of 2,500 KN. Considering the loss of tension into the wires, the blocking force ( $F_b$ ) of 1840 KN and the operation charge ( $F_e$ ) of 1450 KN that is  $F_b = 1.27 F_e$ . Tensioning was carried out up to the checking charge ( $F_v$ ) of 2010 KN ( $F_v = 1.1 F_b$ ) which was maintained 10 min and if slipping was greater of 2 mm everything was let clown in steps up to 1150 KN, then tensioning was relaken up to the blocking charge (fig.7)

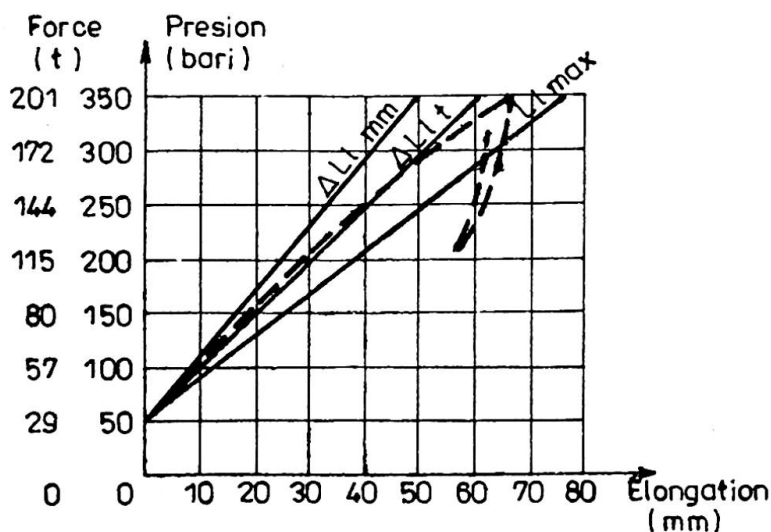


Fig.7 Diagramme of the tie-bar tensioning



If slipping surpassed 2 mm the duration of recharging was prolonged with 20 min and if lengthening was stationary, the tie bar was considered as good. If not, pressure was lessened to zero and everything was recharged at a checking charge 10% lesser and was blocked at a charge also 10% lesser. For about 10% of the tie bars the effort checking was made by blocking detachment. At the detachment moment the reading on a manometer was not less than 3% that the blockage value, admitted.

As compared to the total number of 1224 tie-bars, the charge after the blocking was of 1140 pieces (93%) between 1840 KN (blocking charge) and 1660 KN (blocking charge reduced by 10%). From the rest of 7% to 50 pieces (4.1%) the charge after blocking was between 1660 KN and 1450 KN (operating charge). From the 34 tie bars with remaining charge after a blocking less than 1450 KN, 23 pcs (1.9%) were reconditioned after some checkings of the real operation charge considering the interlocking with the neighbouring tie-bars and the surface of the foundation platform and 11 tie-bars (0.9%) were remade in the neighbourhood.

#### 6. CHECKING IN TIME OF TIE BARS BEHAVIOUR

In order to check in time the efforts inside the tie-bars, some of them were provided with tensiometrical, electroacoustical doses, making periodical measurements.

In the first 5 years, the initial effort decreased by 1-1.5% which is admitted by the project (fig.8)

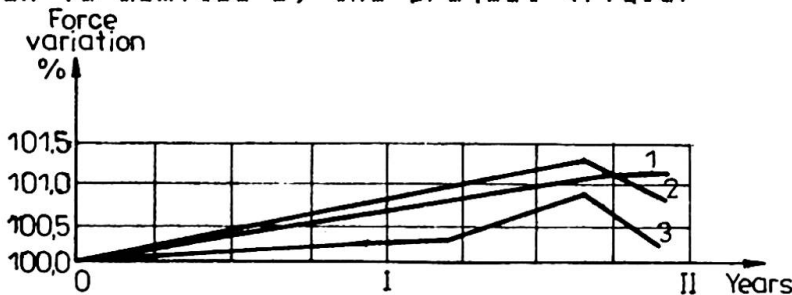


Fig.8 Variation in time of the tie-bar force  
1,2,3 -the tie-bars

There have also been made checkings for environment corrosion on the tie-bars wires.

It could be noticed that the protection materials do not present aging phenomena.

#### 7. CONCLUSIONS

By applying the solution of interlocking the concrete structure with the rock by means of tie-bars important advantages were obtained.

The use of tie-bars with a pre-bulb has the advantage of reducing tensions in the bulb which contributes to a greater lasting and to a good behaviour of the work.

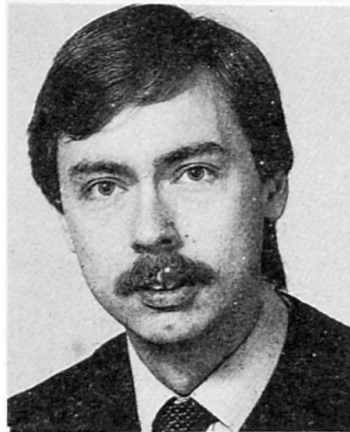
## Mobile Arena: a Tensioned Fabric Multi-Hall

Arène mobile: une structure en tension

"Mobile Arena": eine membranüberdachte Mehrzweckhalle

### M.J. COOK

Executive Partner  
Buro Happold,  
Bath, UK



Michael Cook, born 1955, obtained his engineering degree from Cambridge University and his second degree from Bath University. He has worked with Engineering Consultants Buro Happold since 1982 and has been particularly involved in the design and construction of wide span and flexible structures in the UK, USA, Saudi Arabia and Hong Kong.

### Ian LIDDELL

Partner  
Buro Happold  
Bath, UK



Ian Liddell is the second partner of Buro Happold, consulting engineers. In the past fifteen years he has been responsible for a number of cable and fabric structures and other specialist engineering projects carried out by the office.

## SUMMARY

This paper describes the recent design and construction of a mobile tension structure in the UK. The Arena provides a column-free area 79m by 54m with internal heights to 19m and a very high roof loading capacity. Rapid erection, dismantling and easy transport were important features of the design.

## RÉSUMÉ

L'auteur décrit la conception et la construction récentes d'une structure de tension mobile au Royaume-Uni. Cette arène offre une surface sans colonnes de 79m sur 54 avec des hauteurs intérieures de 19m et une portance du toit très élevée. Elle se caractérise par un montage et démontage rapides et est aussi facile à transporter.

## ZUSAMMENFASSUNG

Dieser Beitrag beschreibt die jüngste Konstruktion und Montage eines mobilen Zugspannungstragwerks in Großbritannien. Die Arena besteht aus einer frei überspannten Fläche von 79m mal 54 m einer Innenhöhe von 19m und einer sehr hohen Dachbelastungskapazität. Schneller Auf- und Abbau und problemloser Transport wurden bei der Konstruktion besonders berücksichtigt.





## 1 INTRODUCTION

The clients for the Arena, 'Mobile Entertainment Centres Ltd', commissioned Buro Happold as structural engineers in 1989. They required the development of a building system which would provide the entertainment industry with a multi-purpose venue which could travel to its own audience. Prime considerations for the design were:

- (1) An extendable structural system to seat up to 10,000 people
- (2) Ease of transport, construction and dismantling (erection time up to five days)
- (3) Interior ceiling height of 19m to allow overhead lighting and sound equipment over central area
- (4) Roof capacity to carry up to 30T on every frame for performance equipment
- (5) Completely column-free interior
- (6) A pyramid form to be expressed externally
- (7) Structure to be capable of use throughout the UK, Europe and USA - design wind and snow loadings to comply with current building requirements
- (8) Reusable anchorage system for wide range of ground conditions.

A prototype structure was fabricated and erected in the UK in 1990. This comprises a 'two pyramid' configuration, internal length 79m, internal width 54m with a seating capacity of about 5,000. Overall footprint of the structure is 90m by 70m. Internal volume 40,000m<sup>2</sup>. Configurations of up to four pyramids are envisaged to seat 10,000.

## 2 PRIMARY STRUCTURE

The primary load carrying system comprises five tubular steel portal frames with legs splayed at 45° set at 12.5m centres. These have a clear span of 63m. These portal frames are linked by tubular steel trusses of similar cross section to form a 12.5m square structural grillage 19m above the ground. The ends of the structure are closed by raking trusses which provide longitudinal stability to the linked portal frames. The frames stand on steel base plates anchored to the ground with screw anchors.

The trusses all break down into 6m lengths weighing 800kg for transportation. In addition there are special sections for the joints. The cross section is trapezoidal, 1168 mm deep by 928 mm at the top and 548 mm at the bottom. This enables eighteen sections to fit within the truck loading section and allows space for maintenance access within the trusses. The sections are joined by four vertical plates and single large pins. These joints fit within the cross section of the 168 mm diameter tubes and can take the full tensile capacity of the tubes.

## 3 ALUMINIUM PYRAMID LEGS

Standing astride the Arena there are two pyramid frames 36m high towards which the roof fabric is tensioned to create two conical peaks. This adds greatly to the dramatic effect of the building. Each pyramid has four legs 50m long formed from aluminium trusses with a triangular cross section. These trusses break down into 6m lengths for transportation and the cross section has been designed to be very compact so that 25 elements can fit into the standard truck section. Each section weighs 150 kg and can be handled by two men. The jointing system is similar to the steel trusses.

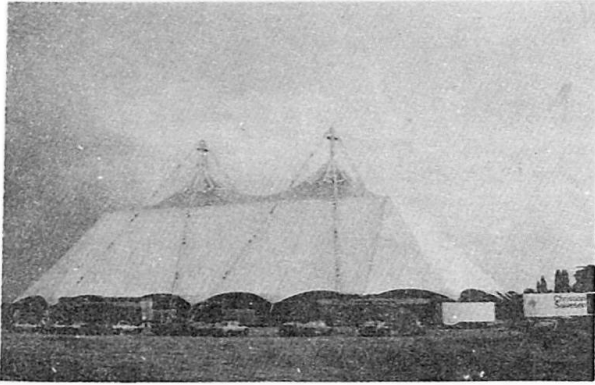


Figure 1 - The Prototype Arena

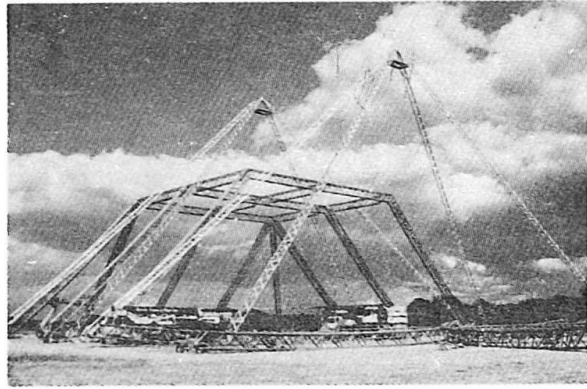


Figure 2 - Framework during erection

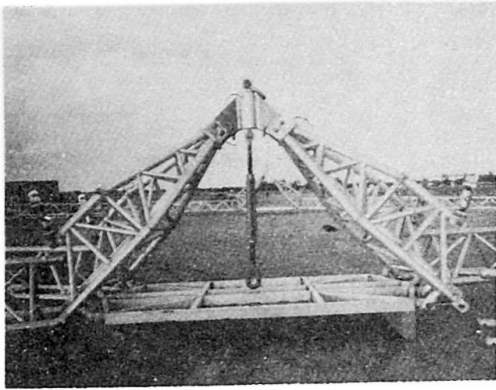


Figure 3 - Apex of pyramid legs

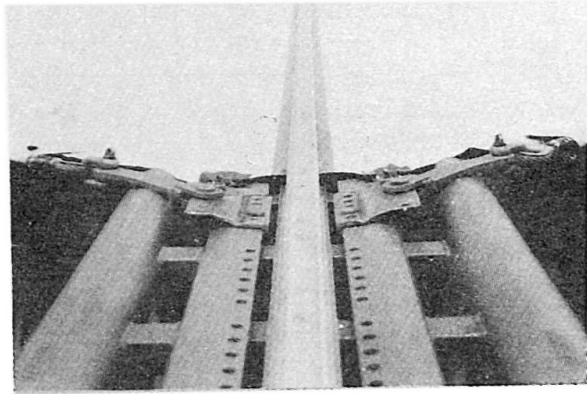


Figure 4 - Membrane panel perimeter detail

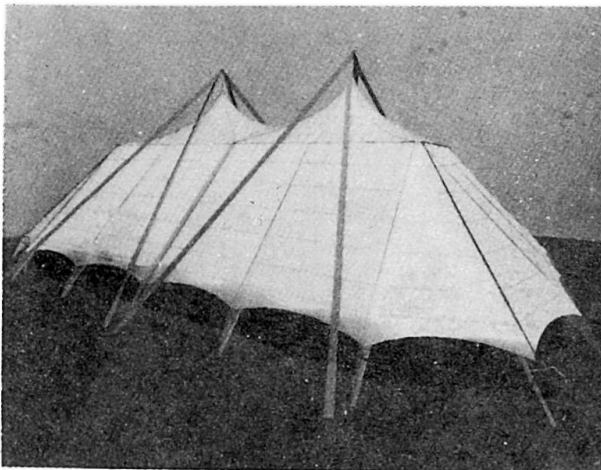


Figure 5 - Analysis model

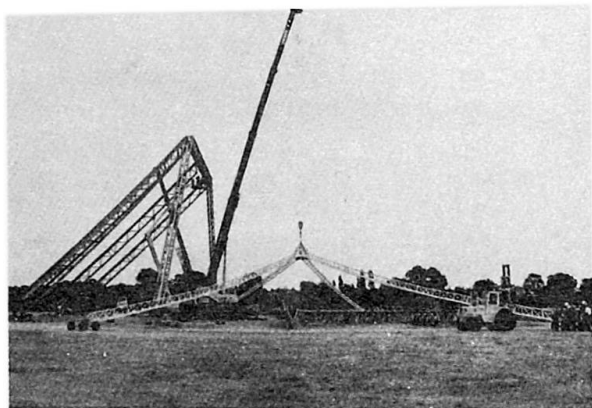


Figure 6 - Erection: raising pyramid



## 4 FABRIC CLADDING

### 4.1 Side Panels

The tensioned fabric cladding was the key to the design of the Arena structure. The sloping sides are infilled with flat panels of fabric 12.5m wide by 25m long. The fabric was Type 3 PVC-coated polyester, 1050 gms/m<sup>2</sup> with a strip tensile strength of 100 kN/m. The long edges are finished with a 'Keder' roped edge which fits into an aluminium luff groove extrusion bolted to the trusses. The top edge is connected at points to the truss while the bottom edge has a catenary cable boundary. For installation the panel was made 40 mm over size. This reduced the fabric tensions sufficient to allow the specially treated Keder edge to slide into the luff groove. The edge of the cloth was hauled up with a wire rope halyard running over a fixed sheave.

The warp direction of the cloth runs horizontally. When installed the fabric is tensioned in the fill direction by hauling down on the catenary cable to induce a tension of 5 kN/m. The fabric stretches in the fill direction and the crimp interchange effect causes the warp to shrink, pulling out the 40 mm slackness and inducing some tension.

Under wind loading the flat fabric deflects and the radius of curvature of the cloth decreases until the tension equilibrates with the applied pressures. These fabric panels have performed excellently in practice. They do not flap or wrinkle and the deflections are not alarming. If such panels were fixed horizontally there would be a danger of ponding, the question is how much slope is required to prevent this.

### 4.2 Top Cones

Each roof cone covers a plan area of 25m x 25m. The edges are fixed to the outer trusses at 1.5m spacing using webbing belts and ratchet buckles. The cones are made of Type 4 fabric, patterned to shape and tensioned by pulling the peaks up to the apices of the aluminium pyramids and holding them with rigging screws.

Each cone is patterned into four fields with belts running out to the corners. Flaps are used to seal the joints with the side panels which are closed with PVC zips. The fabric is installed by hoisting it up as a bundle and pulling out the corners. Ventilation is provided by a large area of plissé fabric around each peak. This consists of folded strips of PVC fabric welded on to a mesh. It keeps the rain out and is flexible.

The form finding load analysis and patterning of the fabric cones were carried out using the TENSYL analysis suite, as described in the accompanying article by Dalland/Gill. [Ref 1] Wind loads were taken from the results of wind tunnel tests at Bristol University.

## 5 WALLING SYSTEM

The 5m high vertical perimeter wall consists of aluminium posts at 2.5m spacing fixed to the ground and to a horizontal truss spanning between frames. For a frequently moved structure the posts are infilled with PVC panels slotted into luff grooves. For a semi-permanent installation rigid panels could be substituted. The clearance is such that articulated trucks can be driven into the building through roller shutter doors and temporary buildings can be 'plugged in' to the walling system.

## 6 INSTALLATION

The procedure involved laying out the trusses on the ground and lifting them by crane. An end portal frame was erected first and propped by the raking end trusses. The erection then proceeded frame by frame along the axis of the hall, each frame being stabilised by the infill members. The aluminium pyramids were lifted before the steelwork when the crane was in the appropriate place. The main steel being completed, the walling trusses were installed and then the side panels could be hauled up the luff grooves. The top cones were the final part of the cladding to be

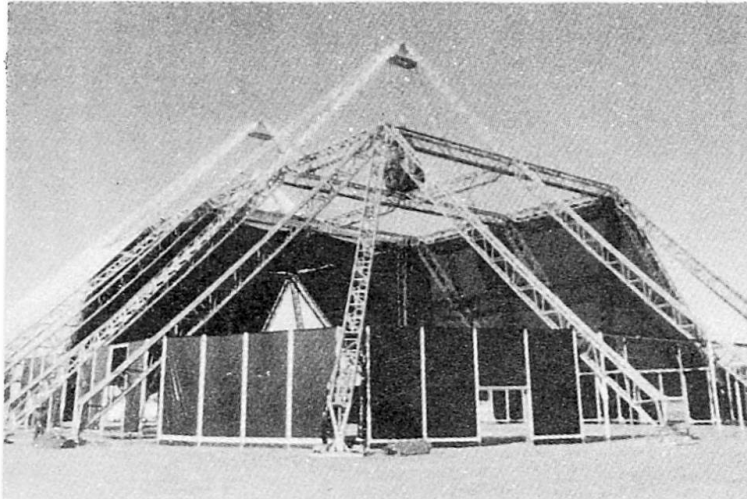


Figure 7 - Erection: installing fabric

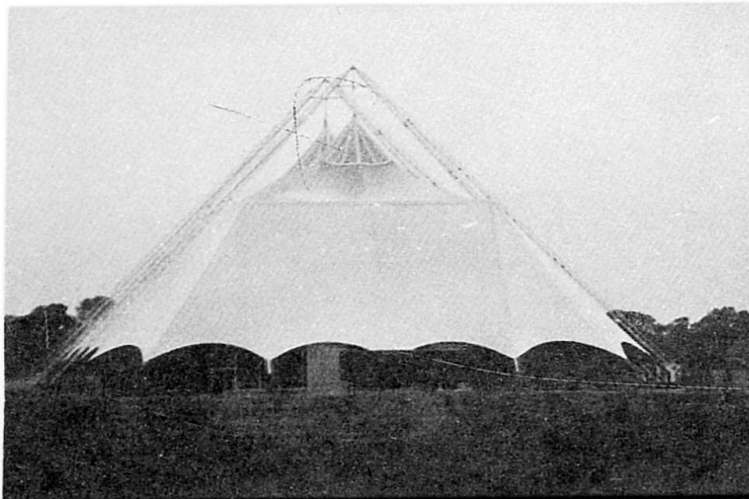


Figure 8 - Completed structure

installed. On the second installation the time was less than the required period of five days.

#### ACKNOWLEDGEMENTS

**The Client:**

Mobile Entertainment Centres Ltd, 201 Coventry Road, Birmingham B10 0RA

**Steelwork Fabricators:**

Tubeworkers Ltd, Claverdon, Warwicks CV35 8PR

**Membrane Fabricators:**

Landrell Fabric Engineering, Station Road, Chepstow, Gwent NP6 5PF

#### REFERENCE

- [1] DALLAND, T and GILL C 'Interactive graphic CAD for tension structures as used for the design of the new concert pavilion, Pier 6, Baltimore'

Leere Seite  
Blank page  
Page vide

## Design of the New Concert Pavillon, Pier 6, Baltimore, USA

Projet d'un espace de concerts à Baltimore, USA

CED-Entwurf eines Pavillon-Membrandaches in Baltimore USA

**Todd DALLAND**  
Principal  
FTL Associates  
New York, NY, USA



Todd Dalland graduated from Cornell University with a Bachelor of Architecture. He began his career in tensile structures in 1971 and founded FTL Associates in 1977. He is a founding Executive Committee Member of the Architectural Fabric Structures Institute, 1984 Chairman of the International Symposium on Fabric Architecture, and a founding director of Surface Forms Research Group.

**Colin GILL**  
Princ. Engineer  
Buro Happold  
Bath, UK



Colin Gill, born 1952, graduated in Civil Engineering from Southampton University in 1973 and obtained his MSc in Concrete Structures at Imperial College, London, in 1980. After initially specialising in highways structure design, he has for the past eighteen months been Principal Engineer with Engineering Consultants Buro Happold, responsible for lightweight structures.

### SUMMARY

This paper describes the mode of operation of the TENSYL form-finding load analysis and cutting pattern generation suite of programs from the user's standpoint. It is illustrated by reference to the new Baltimore Pier 6 concert pavillion in which these techniques were successfully used.

### RÉSUMÉ

L'auteur décrit le mode de fonctionnement du progiciel TENSYL, et ses fonctions de recherche de formes d'analyse des charges et de génération de patrons de coupe, du point de vue de l'utilisateur. Les exemples font référence au nouveau pavillion de concerts Baltimore Pier 6, dans lequel ces techniques ont été utilisées avec succès.

### ZUSAMMENFASSUNG

Der Beitrag beschreibt aus der Sicht des Anwenders, wie das Programmsystem TENSYL für Membrantragwerke zur Formfindung in der statischen Berechnung und zur Generierung der Schnittmuster eingesetzt wird. Illustriert ist die Vorgehensweise am neuen Konzertpavillon "Pier 6" in Baltimore.



Surface-stressed tension structures are necessarily built with totally prefabricated elements of complex geometry. Within the current state of the art it would be impossible to process this geometry without computer techniques. Buro Happold use TENSYL, an integrated program suite which handles shape generation, load analysis and fabrication information for cable and fabric structures. The hardware for this program is a Hewlett Packard 9000/350 workstation with SRX graphics processor and a high resolution 19" colour monitor. The computer uses the UNIX operating system and TENSYL is written in C programming language. The SRX graphics processor gives very fast processing of 3D surface modeled images with a simultaneous display of over 16 million different colours. This program suite replaces the old TENSYL, which ran on an HP 9845 desktop computer.

This paper is illustrated by reference to the design of the new concert pavilion in Baltimore's inner harbour, which replaces the previous fabric pavilion built in 1980 by the same design team. The new pavilion covers approximately 3,000 seats with an additional outdoor seating area to accommodate 1,000 people. Dressing rooms and public toilets are housed in attractive permanent structures directly behind the stage. As an expanded and improved facility, it keeps pace with the rapid eastward development of the inner harbour and maintains a public-spirited covered building for music and recreation on Pier 6. The new building sits centrally on the pier with a water's edge promenade along each side. The entrance to the site confronts the city with a strong, bright facade and gates. The access to the theatre leads through an outdoor lobby and small water-front village of soft-coloured buildings via the water's edge promenade into the theatre and grassy hill beyond.

The new building reflects the changes in design philosophy of the design team. The dialogue between the hard and soft buildings has been developed and the structural form of the hard and soft buildings are integrated. The high-tech structural details have been modified and refined to become decorative elements around the perimeter.

## USER INTERFACE

In TENSYL there is a graphical image of the numerical model on the monitor at all stages of the program. Simultaneously a menu of commands is displayed on the right hand side of the screen. These commands may themselves perform a function directly or provide access to a further menu of commands. Figure 1 shows the *Home* menu. Most of the options on this menu take the user into specific command menus.

Both the menus and the graphics model are driven by the user using a two button mouse. The mouse moves an on-screen cursor. The right hand button switches the cursor between model and menu interaction modes while the left hand button initiates the desired action. Direct keyboard entry of data is kept to a minimum. When necessary a prompt and editing display zone is activated below the graphics display area.

## THE DESIGN PROCEDURE

To set up a numerical model for a membrane structure it is first necessary to define the membrane system points by keying in the co-ordinates. The system points are mast tops and fixed points on the boundary. Boundary lines and ridge lines connecting these points are then defined using the mouse on the *Topology* menu. The membrane surface is divided into fields by ridge lines. Each field must be surrounded by a closed boundary of cable or rigid elements.

The mesh generator is used to subdivide each field into a rectangular mesh. Using the mouse the mesh is sketched onto a screen display of the field's boundaries. The mesh lines run from boundary

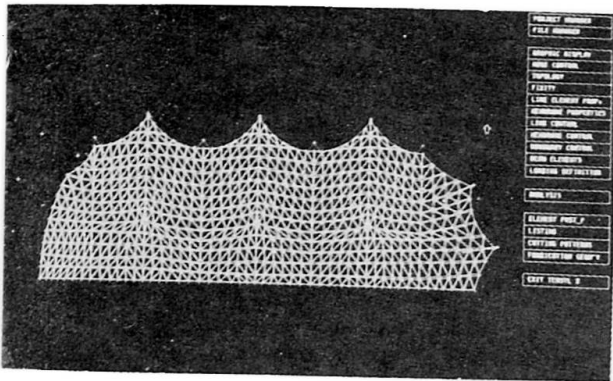


Figure 1 - TENSYL Home menu

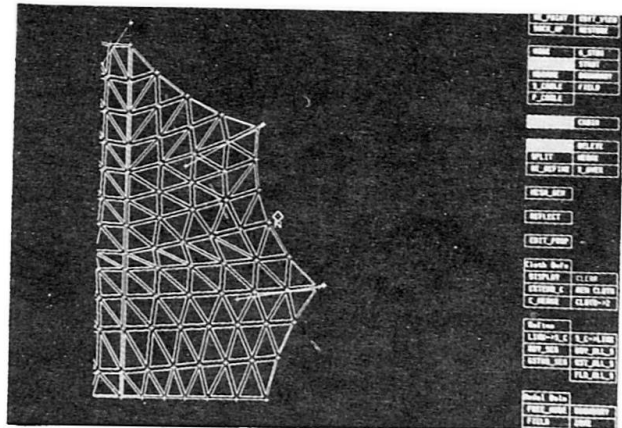


Figure 2 - Topology menu: adding link to boundary cable

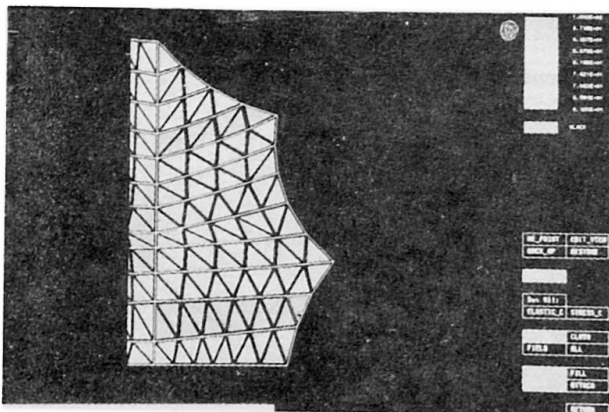


Figure 3 - Membrane stresses display

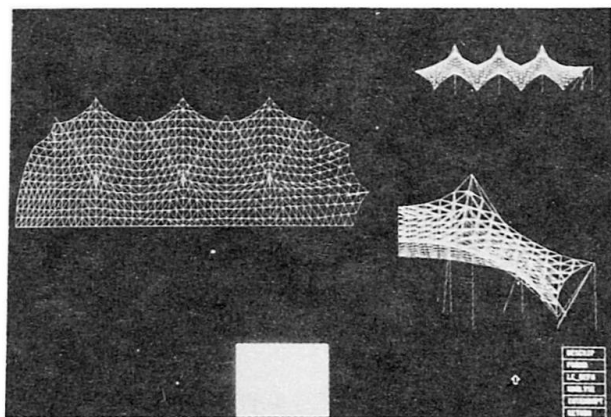


Figure 4 - Graphic display during analysis

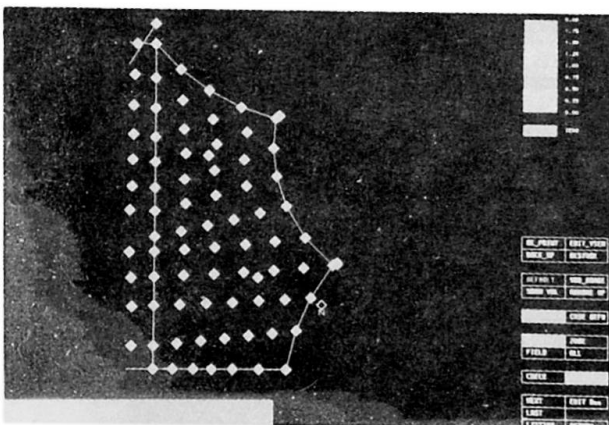


Figure 5 - Loading coefficient nodal display

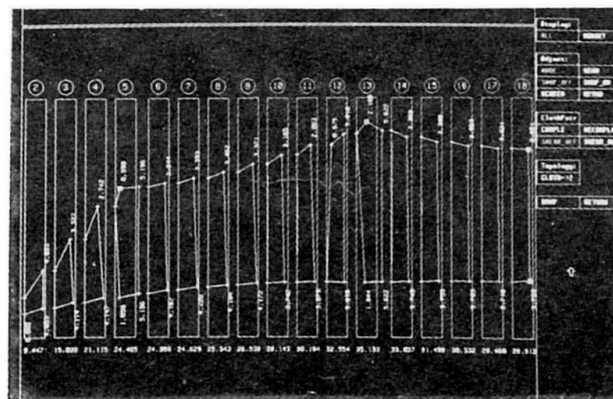


Figure 6 - Cutting pattern field display





to boundary in roughly orthogonal directions. The lines can be added in any order and adjusted using *Delete* and *Command* options. When complete the mesh can be solved to generate the spatial coordinates of the node points at the crossovers.

Once solved, membrane and geodesic line elements are then automatically generated within the rectangular topology. The geodesic lines *Gstrings* are potentially seam lines on the surface and serve to order the triangular membrane elements. Having exited the mesh generator, then individual elements of any type may subsequently be added, deleted or edited directly on the screen using the *Topology* menu. (Figure 2)

Node restraint conditions can be activated graphically using the *Fixity* menu with direct attachment or detachment of a selected combination of translational fixities. There are no limits to the number of restraints, as these are held within a node's internal data structure. Likewise element elastic properties and specified stress levels are attached and assigned on screen using the *Line Element Properties* or *Membrane Properties* menus. Elements are filled with varying colours to illustrate magnitudes of stress. (Figure 3)

For form generation specified stress membrane elements will be used with boundary elements being assigned mostly elastic properties. It is usual to assign a few links with specified tensions to adjust boundary shape or the equilibrium at a certain node but care must be taken to keep the model in control.

Form generation and load analysis use the same analytic section of the program. The solution procedure is 'dynamic relaxation' in which each node is moved towards its equilibrium position by the out-of-balance forces on it in accordance with Newton's laws of motion. [Ref 1] The graphic display during analysis shows both plan and elevations of the problem, which are updated at interim solution points as the analysis proceeds. (Figure 4) The node with the current maximum out-of-balance residual force is flagged, to aid the detection of physical instabilities. Analysis control parameters and load case numbers are assigned via on-screen edit boxes.

For load analysis the structure is fully elasticated. In this operation the specified stress elements are replaced by elastic elements; the slack length of the element being adjusted so that at the prestress geometry each element has the same stress as before.

Individual nodal loading coefficients are assigned interactively on a separate command page. Up to five sets of coefficients may be held at any one time. These coefficients are multiplied by wind or gravity loading factors when defining a particular load case (Figure 5). Combined cases are permissible, together with the application of an internal pressure which might represent the inflation of an air-supported structure or an internal wind pressure.

The post processing module gives a colour display of element stresses, and facilitates the rapid assimilation of a large amount of data. Hard copy listings of all results and co-ordinates may be output via a laser printer, which can also be used for graphics dumps of the screen image.

The fabrication geometry module provides for the generation of membrane cutting patterns (Figures 6 and 7) and associated component geometry, such as masthead and membrane plate angles. Adjustment of boundary node positions for cloth width optimisation is assisted by an on-screen display of all the unfolded cloths associated with a particular field.

## STRUCTURE VISUALISATION

An advanced structure visualisation module has been included in TENSYL to aid the interpretation of complex surfaces and their relationship to adjacent solid elements. Coupled with the high form computation, this creates a powerful interactive facility for architectural interpretation at preliminary design stages, as well as providing high quality images for presentation to the client. This module of TENSYL makes full use of the SRX graphics coprocessors attached to the workstation. These provide hardware implementation of hidden surface removal, smooth surface shading, multiple light sources and full surface texture and specular reflection modelling (Figure 8).





In addition the surface representation of complex elements is assisted by the support of non-uniform rational spline surfaces.

The analytic model has been supplemented by the addition of further modelling primitives. These include general brick elements, walls, floors, and straight or radiused tubes or rectangular sections (Figure 9). Individual textures and colours may be assigned to these additional elements, which may also be displayed in outline form as wire frame models.

Varying degrees of transparency may be assigned to the membrane. There are a number of lighting options including ambience, parallel and point light sources which can all be assigned different colours, intensity and location. The model can be viewed from any point with a view ranging from wide angle to telephoto. Rapid changes of viewpoint allow walk through effects.

#### APPLICATION TO BALTIMORE PAVILION

The potential benefits of the fully interactive CAD system in the new TENSYL program were realised on the Baltimore project. From an engineering user's standpoint the system is easy to learn and popular in use, mainly because of the elimination of tedious manual manipulation of large data files. Early projects indicate a minimum five-fold improvement in total time taken for numerical model assembly and application. The analytic section of TENSYL now computes about sixty times faster than the old version. When coupled with the high quality visualisation capability, this speed of form generation and adjustment made it practical for the architect to work directly alongside the engineer at the preliminary design stage. This joint interactive involvement benefitted the project, and has particular relevance with the increasing use of tensile elements integrated into a total building.

As part of the structural design on Baltimore it was required to maintain the ridge and valley cables on lines secure across the access and to get repetition of fabric patterns where possible. This was achieved by form finding a typical centre field then reflecting it and elasticating it where identical fields were required. The end fields which were different were then form found on to the already elasticated part. It was found that the stresses in the elasticated parts changed from the originally specified stresses but not sufficiently to cause any over stressed or slack elements. The completed project is shown in Figures 10 and 11.

#### FUTURE DEVELOPMENTS

The areas where there is room for further extension of the numerical processing procedures are in the use of automatic cutting pattern machines and the development of shop drawings for the various supporting hardware and connection plates. At the moment the patterns are output as system line geometry. If automated pattern cutting is introduced, the seam margins and other edge detail corrections need to be added into the patterns. The supporting steelwork details, particularly the corner plates where boundary cables are connected back to the masts are developed by hand from geometrical information taken from the cutting pattern module. We are presently working on data transfer to an AUTOCAD draughting program in which a library of details can be set up. This will help to reduce the risk of errors at this interface and speed up the production of shop drawings.

#### ACKNOWLEDGEMENTS

The photographs of the completed project provided by fabric contractor Clyde Canvas Ltd are gratefully acknowledged.