

# Floating islands "Marinarium"

Autor(en): **Dziewolski, Richard**

Objektyp: **Article**

Zeitschrift: **IABSE congress report = Rapport du congrès AIPC = IVBH  
Kongressbericht**

Band (Jahr): **14 (1992)**

PDF erstellt am: **23.07.2024**

Persistenter Link: <https://doi.org/10.5169/seals-853156>

## **Nutzungsbedingungen**

Die ETH-Bibliothek ist Anbieterin der digitalisierten Zeitschriften. Sie besitzt keine Urheberrechte an den Inhalten der Zeitschriften. Die Rechte liegen in der Regel bei den Herausgebern.

Die auf der Plattform e-periodica veröffentlichten Dokumente stehen für nicht-kommerzielle Zwecke in Lehre und Forschung sowie für die private Nutzung frei zur Verfügung. Einzelne Dateien oder Ausdrucke aus diesem Angebot können zusammen mit diesen Nutzungsbedingungen und den korrekten Herkunftsbezeichnungen weitergegeben werden.

Das Veröffentlichen von Bildern in Print- und Online-Publikationen ist nur mit vorheriger Genehmigung der Rechteinhaber erlaubt. Die systematische Speicherung von Teilen des elektronischen Angebots auf anderen Servern bedarf ebenfalls des schriftlichen Einverständnisses der Rechteinhaber.

## **Haftungsausschluss**

Alle Angaben erfolgen ohne Gewähr für Vollständigkeit oder Richtigkeit. Es wird keine Haftung übernommen für Schäden durch die Verwendung von Informationen aus diesem Online-Angebot oder durch das Fehlen von Informationen. Dies gilt auch für Inhalte Dritter, die über dieses Angebot zugänglich sind.

## Floating Islands "Marinarium"

Iles flottantes "Marinarium"

Schwimmende Inseln "Marinarium"

### Richard DZIEWOLSKI

Dr. Eng. Arch.  
CCERET — ENGINEERING  
Boulogne Billancourt, France



Richard Dziejowski born in 1935, obtained his civil engineering degree at the Polytechnical Institute of Warsaw (1958), his Doctor of Engineering from the Faculty of Science of the University of Paris (1963) and his Architect's degree DPLG in Paris (1970). In 1968 he opened his own Consulting Engineering firm called the CCERT-ENGINEERING and in 1970, his own Architectural firm Richard Dziejowski.

### SUMMARY

This article presents the plans of two offshore "Marinarium" resort complexes which are covered by the author's patents and models. From 20 to 65 meters deep, the platforms are fixed, and from 50 to 2000 meters deep, they are floating.

### RÉSUMÉ

L'article présente les projets de deux complexes de loisir offshore "MARINARIUM" qui ont fait l'objet de dépôt de brevets et de modèles par l'auteur: plateforme fixe pour 20 à 65 mètres de profondeur d'eau et plateforme flottante pour 50 à 2000 mètres de profondeur d'eau.

### ZUSAMMENFASSUNG

Der Artikel stellt die Projekt der beiden Offshore-Vergnügungsparkkomplexe "Marinarium" vor, die zusammen mit den Modellen des Autors patentamtlich geschützt wurden: eine feste Plattform für 20 bis 65 m Wassertiefe und eine schwimmende Plattform für 50 bis 2000 m Wassertiefe.



## 1. INTRODUCTION

The technical progress made over these last two decades in the field of offshore engineering is expected to have a considerable influence on housing modes and on the leisure time activities of future civilisations.

Man came out of the sea and will return to the sea...

By the year 2000, we shall perhaps see floating islands springing from the sea, in varied shapes like so many lotuses at the edge of the waves...

Pretty speech, but in France the principle is running into major difficulty: the shorelands protection law which prohibits construction off the coasts.

These regulations are a major obstacle to the development of offshore construction. However, industrialists are hoping to be able to get around these rules one day by clearly proving that a floating island is considerably less polluting for marine fauna and flora than the "unrelieved concreting" of the coastlands.

A vast debate.

At present time is getting short; the needs are becoming acute:

\* **Tourism:** increasing numbers of tourists and saturation of the seaside resort facilities during the summer.

\* **Costs:** land near the shore is more and more scarce and more and more expensive.

\* **Employment:** increasing numbers of unemployed in certain seaside towns due to a major crisis in offshore construction and in shipbuilding. Closure of many Mediterranean shipyards.

The Riviera, one of the most beautiful regions in the world, is practically saturated in the summer by millions of visitors from France and abroad.

A predictable increase in the number of foreign tourists in France in the coming years, larger household vacation and leisure activity budgets and more free time demand major efforts to adapt existing infrastructures to new market needs.

The magnitude of real estate taxes, traffic problems, difficulties in treating wastes and lack of drinking water make the construction of sea side resort complexes more and more difficult.

It has become necessary to look for new solutions.

## 2. OFFSHORE TECHNOLOGY AT THE SERVICE OF HOUSING, LEISURE AND ENTERTAINEMENT

Figures 1 to 8 represent a number of completed projects, to which our design firm has contributed; they demonstrate the technical possibilities of offshore construction.

Certain of these platforms contain residential neighborhoods and technical facilities providing them with full self-sufficiency.

The touristic interest of these projects can be considerably improved by appropriate architectural research, along with research into the choice of forms which fit the marine environment better than certain purely industrial structures.

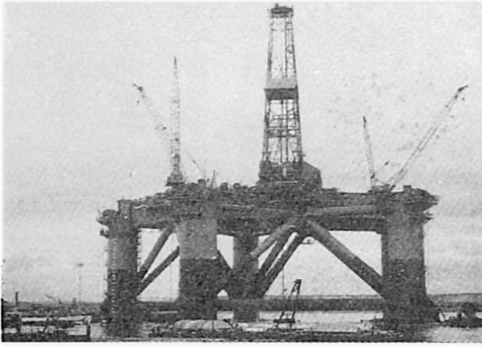

**Fig. 1** Semi-submersible floating platform "PENTAGONE".

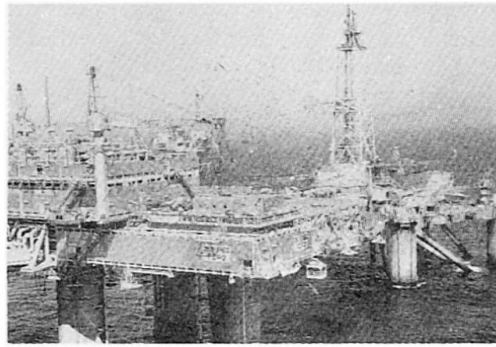

**Fig. 2** Fixed gravity platform TCP2, Frigg North sea.



**Fig. 3** Platform TCP2, during construction

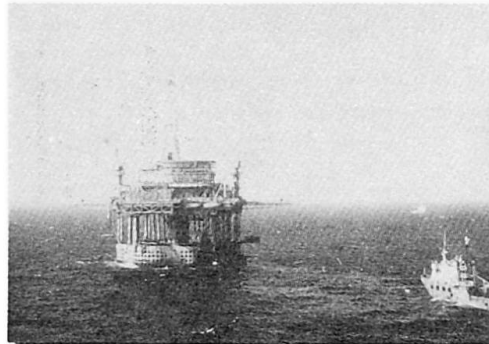

**Fig. 4** Fixed gravity platform Doris, Frigg.



**Fig. 5** Platform TCP2 under construction in Norwegian Shipyard



**Fig. 6** Self-raising platform, "TRIGONE"

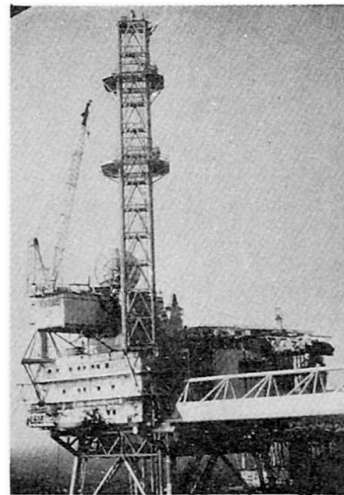

**Fig. 7** Jacket Q.P Frigg (living quarters)



Offshore construction for tourist purposes must not only be easy to install, but must also be easy to service and therefore to dismount. Furthermore, this includes technical installations to make it fully self-sufficient while avoiding all risk of pollution for the environment.

The photos representing open sea offshore platforms demonstrate the colossal size of these works, designed to withstand the forces of hundred year swells, 28 meters high, winds of more than 200 km/h, and these platforms can be constructed at water depths greater than 150 meters.

The technical fallout from these works in the design and construction of buildings can be multiple.

### 3. "MARINARIUM" LEISURE AND ENTERTAINMENT COMPLEXES, EXAMPLES OF THE USE OF OFFSHORE TECHNOLOGY

The studies and research which we have been conducting for more than ten years in the field of leisure and entertainment equipment have led to developing two original tourist products which eliminate the disadvantages mentioned earlier. They are characterized by:

- Choice of an original architecture, fitting well into maritime sites, based on offshore technologies and constituting veritable monuments, an event, a tourist site, an entirely integrated concept.
- Into this monument, installing a leisure and entertainment complex which is exceptional by the diversity and quality of the activities, i.e. housing units, food services, sports, health therapy, seminars, conferences, training courses, exhibitions, retail shops, shows, concerts, games, etc... maintaining tourist activities throughout the year.
- Location of this complex off the coasts in natural settings, entailing no detrimental phenomena.

The first complex, with 5000 beds and 300,000 m<sup>2</sup> (about 3,000,000 square feet), called "MARINARIUM 01" is a gravity type platform for water depths from 30 to 60 m (Fig. 9, 10 and 11).

The second complex with 2000 beds and 175,000 m<sup>2</sup> (about 1,750,000 square feet), called "MARINARIUM 02", is a floating platform, cable anchored for water depths from 60 to 2000 m (Fig. 17,18 and 19).

The clientele for these complexes is:

- visitors (guided visits)
- non resident club members (users of the facilities with or without meals)
- residents (short and long stays plus inclusive charge for activities)

These two projects will be built and equipped entirely in a shipyard, then towed and installed on the site by the use of oil platform techniques (gravity platform or floating platform, anchored by cables).

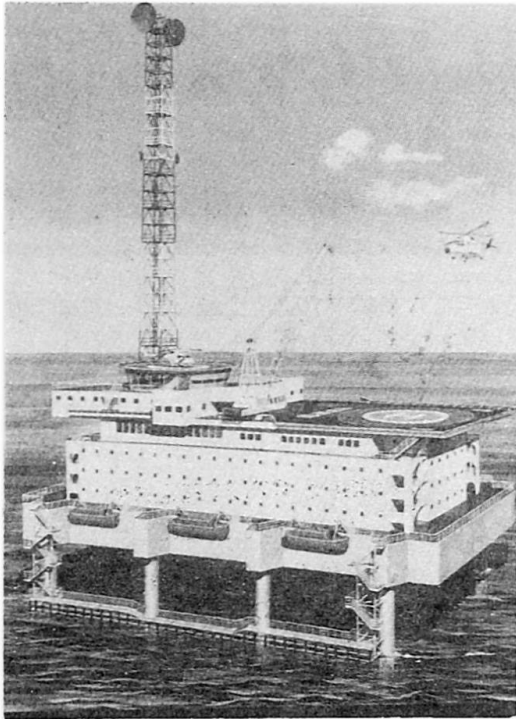

Fig. 8 Barge accomodation, Abu Dhabi Zakum

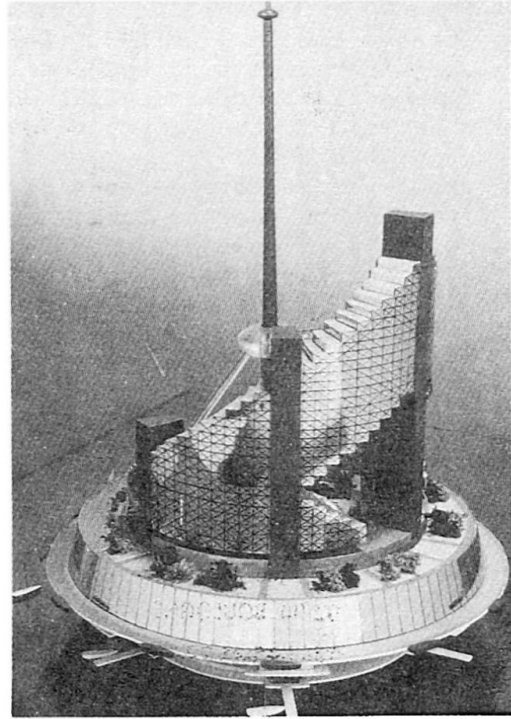
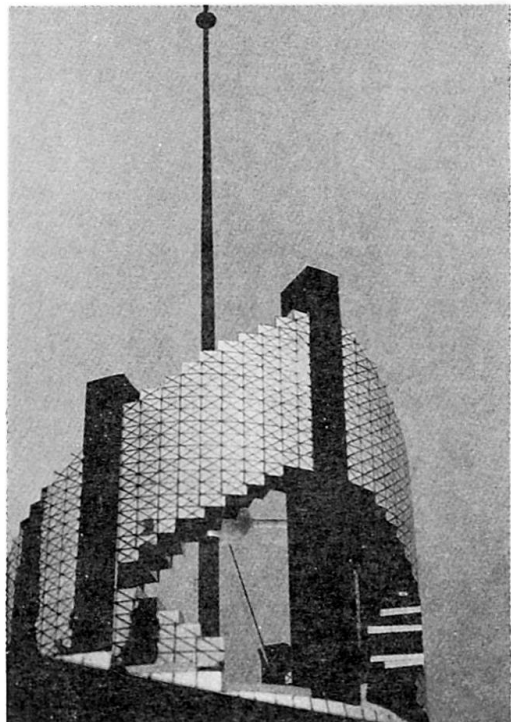
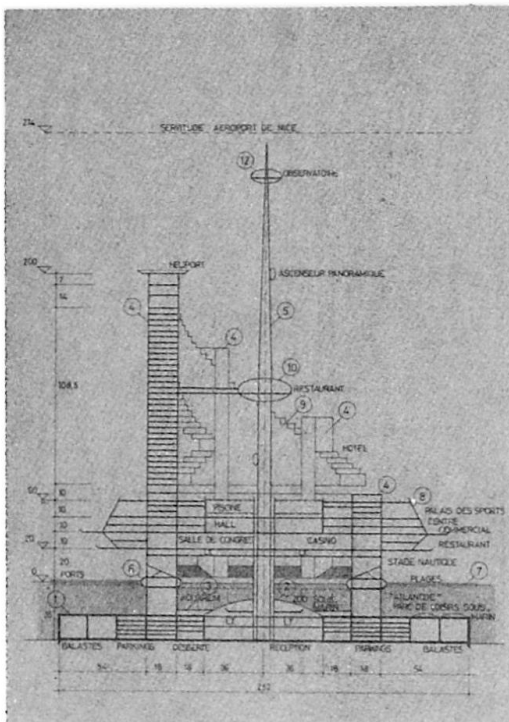

Fig. 9 And 10 photos of the scale module of the MARINARIUM 01 leisure and resort platform.

Fig. 11 Cross-section of the plan for MARINARIUM 01 - Location in Juan Gulf on the Riviera.





In the equipment rooms of these platforms, various facilities are located to guarantee complete self-sufficiency:

- sea water filtering and desalination installation,
- sewage treatment installation,
- household waste treatment installation,
- generator sets,
- fresh water storage tanks or reservoirs,
- hydrocarbon storage tanks.

A set of environmental specifications will be prepared in collaboration with the best specialists to avoid all risk of pollution.

The installation and dismantling of the "MARINARIUM 01" and "MARINARIUM 02" platforms will be easy, with no adverse effects on the environment (ballasting or deballasting of floats or of submersible gravity anchors).

These complexes, constituted as small self-sufficient towns, provide the inhabitants with an exceptional living environment with no detrimental phenomena.

#### 4. DESCRIPTION OF THE "MARINARIUM" CONCEPT AND THE PLANS

##### 4.1. The "MARINARIUM 01" plan

The general architecture and technical concept has already been described in our paper given at the thirteenth conference at Helsinki.

Figure 11 represents the proposed location of the complex in Juan Gulf on the French Riviera.

The plan includes a floating dike protecting the port against swell and an "anti-black tide" system.

The diagrams of the following figures describe the installation phase (fig. 12) and the way the helicoidal volume is built, utilizing prefabricated modules (fig. 13 to 16): orthotropic structure, weight of the module: approximately 26 tons, that is 180 kg/m<sup>2</sup>.

This procedure can be applied in the construction of highrise buildings, thus enabling the creation of varied volumes.

##### 4.2. The "MARINARIUM 02" plan

This plan concerns a floating "offshore" leisure and resort complex, which can be located near the coasts and connected to them with the aid of a floating bridge-tunnel (fig. 18 and 19), or it can be an independent island (fig. 17) containing a marina, sheltered by floating dikes, connected to the platform.

The surface area of the "MARINARIUM 02" platform is 175,000 m<sup>2</sup> (1,750,000 square feet) including 41,000 m<sup>2</sup> (410,000 square feet) of accessible terraces and decks, including:

- Lodgings, divided into 5\*\*\*\*\* hotels, hotel apartments and residential apartments.
- Offices, entirely equipped with built-in logistic services.
- Retail shops and restaurants.
- Areas for sports and leisure time activities (beaches, marina, swimming pools, tennis, golf, squash, water games, ping-pong, billiards, etc...),
- Health therapy (sea-water therapy, gymnastics, massages, sauna, beauty salons,...).
- "Culture-science-entertainment" areas (conference room, meeting rooms, exhibitions, concerts, shows, festivals, motion pictures, etc...).
- A casino.
- A marina.



3 PHASES DE CONSTRUCTION

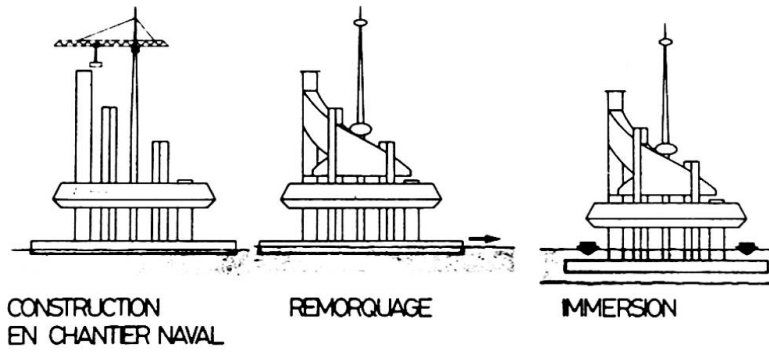

Fig. 12 Construction phases.

SCHEMA DE LA STRUCTURE

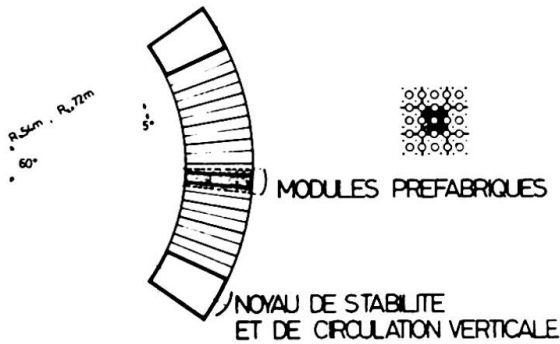

Fig. 13

COUPE TRANSVERSALE

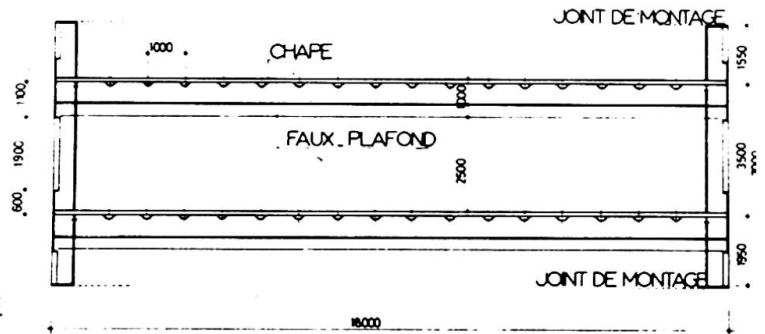

Fig. 14

VUE EN PLAN

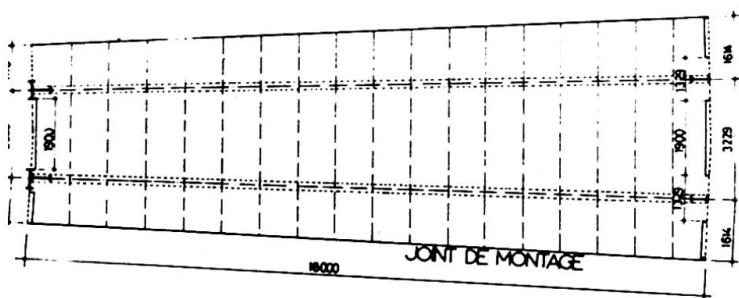

Fig. 15

MODULE PREFABRIQUE

FAÇADE EXTERIEURE R=72m.

FAÇADE INTERIEURE R=54m.

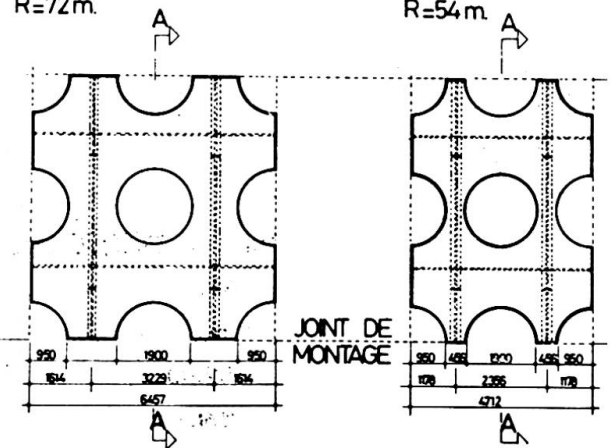

Fig. 16

Prefabrication details of the helicoidal volume by modules in Orthotropic structures.





- An under water oceanographic museum and amusement park.
- Night clubs, dance halls, discoteques.
- Parking for 800 automobiles and 4 buses.
- A heliport.

The originality of the concept is locating a hotel around a tropical garden - circular sports arena, 108 meters in diameter, covered by an air conditioned cupola-glass casing, for the practice of various disciplines throughout the year.

A special mechanism will make it possible to open and close the cupola in summer.

The exceptional quality of the lodgings and of the sports and amusement equipment will attract a large international clientele, always on the look-out for the latest developments, to participate in festivals, conferences, exhibitions, seminars, concerts, shows, private or professional visits, tennis and golf lessons, etc... in an extraordinary setting.

#### Technical characteristics of "MARINARIUM 02"

Maximum diameter: 245 meters (320 meters with floating dikes and the marina).

Height: 48 meters

Draft: 10 meters

Displacement: 190,000 tons.

Water depth: 50 to 2000 meters.

Type of anchoring: cables under tension (patented method).

Usable surface within the structure: 105,000 m<sup>2</sup> (1,050,000 square feet) (not counting parking areas and equipment rooms)

Overall surface: 175,000 m<sup>2</sup> (1,750,000 square feet) (including parking and equipment rooms).

Weight of the metal structure: 23,000 T to 42,000 T depending on the depth.

Storage capacity of reservoirs and ballasts: 50,000 m<sup>3</sup>.

Technical equipment and reserves: self-sufficiency for 30 days.

Protection of the port and beaches against the effect of swell by floating dikes, connected to the platform.

#### 5. ANCHORING DEVICE

The type of anchoring proposed for "MARINARIA 02" will be the same as that developed by the author in 1972 as part of a T.L.P. study (CDP 2000), designed for oil drilling in deep waters.

(French patents no. 2408511 and 2408512 fig. 20 and 21)

The platform anchoring depends of the type of use and the weather conditions (wind, current, swell).

The planned anchoring system provides absolute safety with relation to the stability of the platform under all the operating phases (towing, lowering the gravity anchors into the water, drilling in storms, replacing cables, etc...).

It consists of:

- vertical cables,
- oblique cables in catenary.

The cables will galvanized anchoring cables, standardized AP1 of 3". The cables are multistrand, pulley mounted (the number of strands depends on

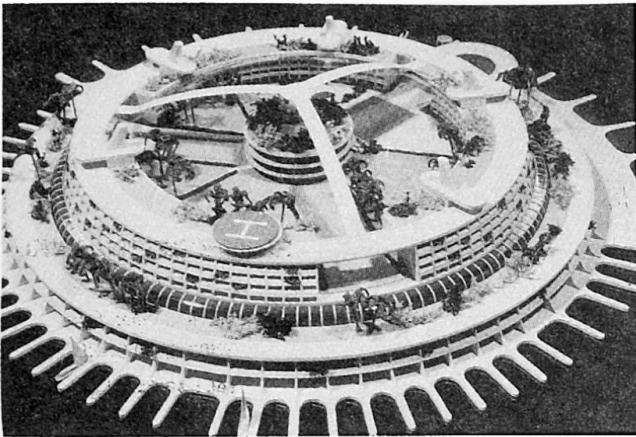

**Fig. 17** Photo of the scale model of the MARINARIUM 02 floating leisure and resort complex.

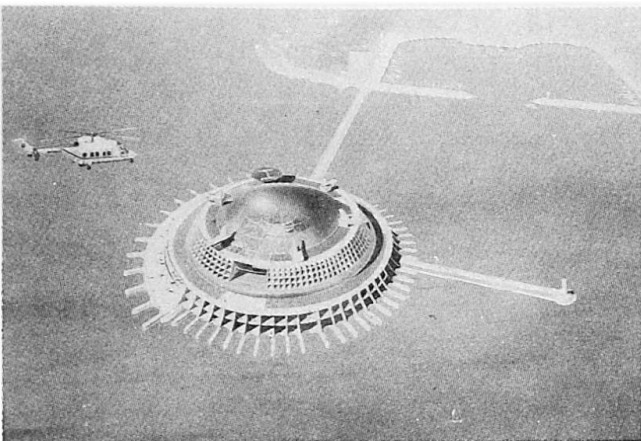

**Fig. 18** Layout plan of MARINARIUM 02 in the port of Monaco.

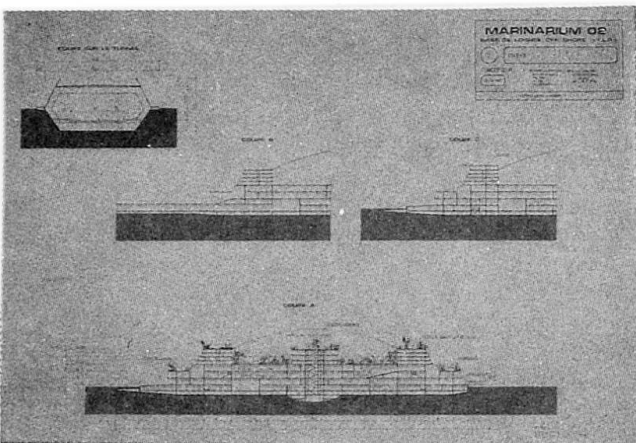

**Fig. 19** Cross-section



the weather conditions, the depth, the live loads and the specific heave cycle which should not be long than 5 seconds). At the upper part, each vertical cable bundle is connected to the winch, and at the lower part, to the submersible gravity anchors.

The three anchoring winches per pier enable:

- lowering and raising the gravity anchors,
- adjusting the cable tension and length.

A special system has been designed to change the cables.

The oblique cables are also pulley mounted and connected on one side to the winch and on the other side to the submerged gravity anchor, or to concreted tubes.

The anchoring system chosen makes it possible to considerably reduce the side to side movement of the platform; this movement does not exceed 10% of the depth under the effect of wind, current and swell during storms.

The oblique cables reduce the stresses in the vertical cables and diminish the platform's yaw and roll movements.

The anchoring system depends on the intended use of the platform (with or without floating tunnel connecting the platform to the shore), on the weather conditions and on the depth.

### Three solutions can be proposed

- Sloping cables in catenary and tensioned vertical cables (in case of the need of limiting the side to side movement and diminishing the heave - linking by tunnel to the shore).

- Sloping cables in catenary: in case the heave, pitch and yaw movements are not detrimental to the correct operation of the equipment (offshore location, depths not exceeding 500 m).

- Vertical cables: in case the side to side movement may be greater than 10% of the depth and for water depths greater than 500 meters.

The anchoring can be adapted to various depths from 50 to 2000 meters.

## 6. GRAVITY ANCHORS

The gravity anchors have three functions:

- floats during the towing phase (draft 12 to 14 meters)
- counterweights for anchoring the vertical cables
- storage reservoirs.

The platform can contain either several independent gravity anchors (fig. 22), or a single one (fig. 23).

The gravity anchors are connected to the platform by hoses and contain ballasting compartments.

The operations for installing the platform on the site are simple and rapid (fig. 24):

- towing the gravity anchors and the fully equipped platform to the site
- submerging the gravity anchors and the oblique cables which are connected to the buoy
- positioning the platform with the gravity anchors, adjusting the tensions on the oblique pulley mounted cables, connected to the buoy and to the winches,
- ballasting the gravity anchors,
- submerging the gravity anchors and descending them using winches (3 winches per pier)
- the complete ballasting of the gravity anchors and the adjustment of the tensions in the vertical and oblique cables with the aid of winches.

PL. 2/2 2408511

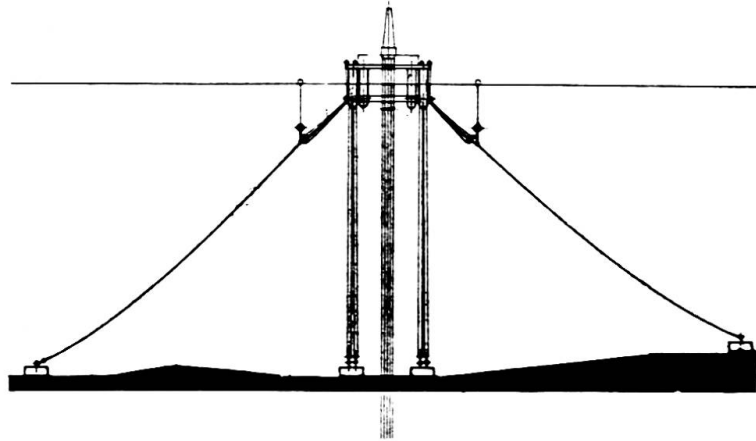
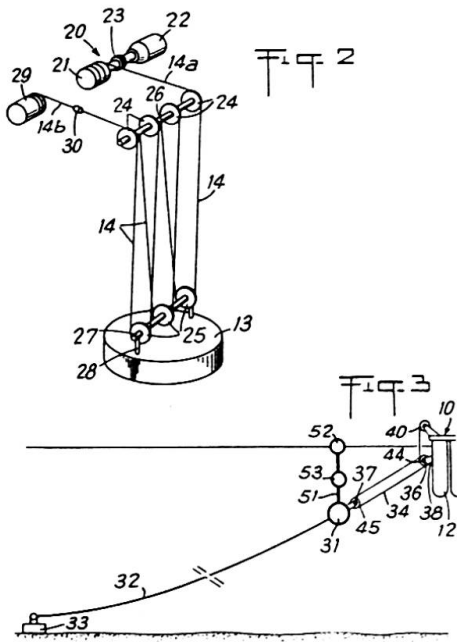

Fig. 21 Anchoring system, consisting of vertical and oblique cables.

Fig. 20 Anchoring diagram, using pulley mounted cables.

Fig. 22 Independant submersible gravity anchors.

Fig. 23 Single gravity anchor, storage tank.

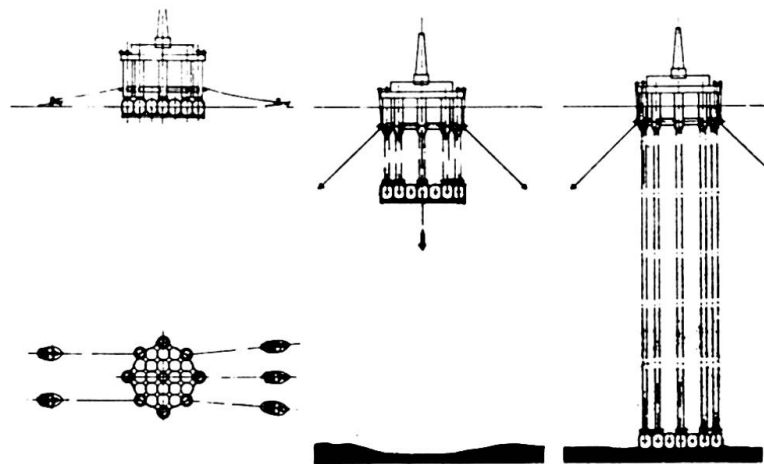
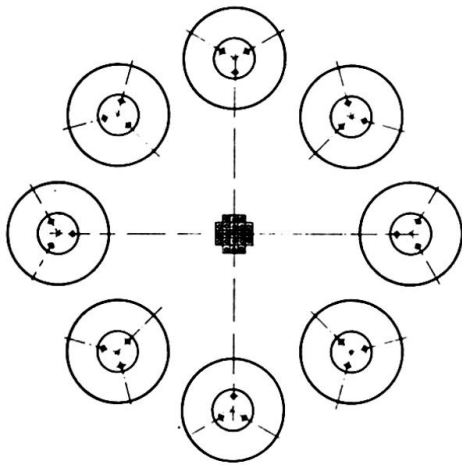
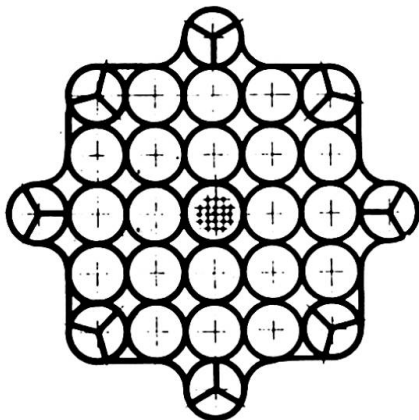

Fig. 24 Diagram of platform installation on the site.





7. EXAMPLE OF A CALCULATION OF ANCHORING FOR A DEPTH OF 500M

PROGRAMME CATMAN  
SCHEMA D'ANCRAGE OBLIQUE

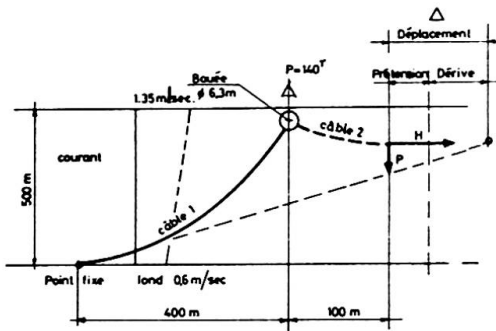

Cable 1 - Longueur 680 m : poids 175 Kg/m  
Cable 2 - Longueur 110 m : poids 130 Kg/m  
E = 1 900 000 Kg/cm<sup>2</sup>

Extreme phase HYPOTHESES :  
wind : speed 62.5 m/sec, current :  
speed 1.35 m/sec, swell 17.4 m/12 sec

The calculations were performed, statically and dynamically, to make it possible to determine the movements of the platform and the stresses in the cables for various time durations, under the effect of swell, current and wind, Figures 24,25 and 26 summarize these results.

Fig. 25 Calculation and design model of the oblique cable.

Fig. 26 Diagram of the variation of the tension in the oblique cable.

Fig. 27 Diagram of the horizontal components in the vertical and oblique cables.

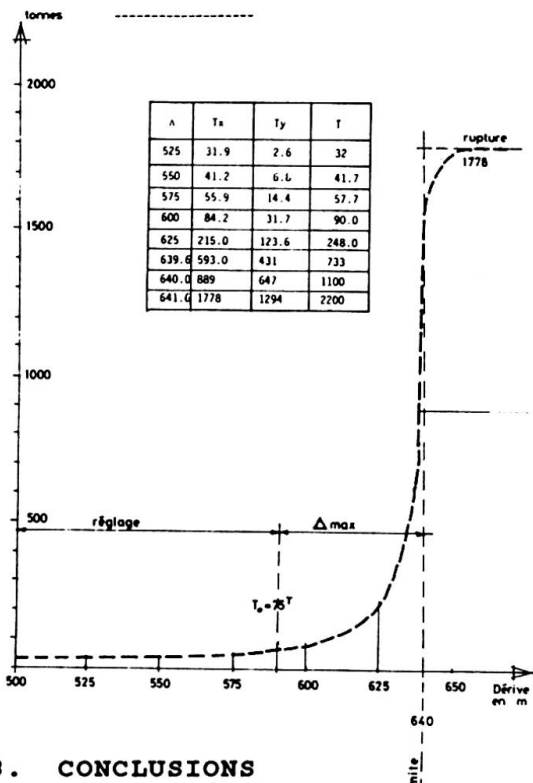

Variation de la composante horizontale dans les câbles en fonction de la dérive de la plate-forme.

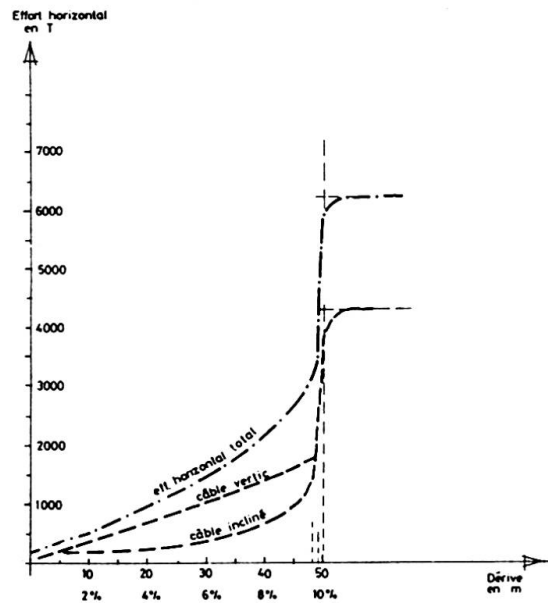

8. CONCLUSIONS

History demonstrates, that major architectural works contribute to enhancing the touristic value of towns and regions, sometimes even nations. The impact of these works on the public makes it possible to launch new architecture styles. The time has come for launching an architecture for the year 2000 : THE ARCHITECTURE OF THE SEA which will become our newest continent. By participating actively in the promotion of exemplary and spectacular projects, public authorities, investors and industrialists will be better able to channel the advertising impact of these projects and profit better from the considerable fallout, (not forgetting the shore law which, in the immediate future is braking the developpement of these concepts...)