

Zeitschrift: IABSE congress report = Rapport du congrès AIPC = IVBH
Kongressbericht

Band: 14 (1992)

Rubrik: Special session 3: Renewable energy structures

Nutzungsbedingungen

Die ETH-Bibliothek ist die Anbieterin der digitalisierten Zeitschriften. Sie besitzt keine Urheberrechte an den Zeitschriften und ist nicht verantwortlich für deren Inhalte. Die Rechte liegen in der Regel bei den Herausgebern beziehungsweise den externen Rechteinhabern. [Siehe Rechtliche Hinweise.](#)

Conditions d'utilisation

L'ETH Library est le fournisseur des revues numérisées. Elle ne détient aucun droit d'auteur sur les revues et n'est pas responsable de leur contenu. En règle générale, les droits sont détenus par les éditeurs ou les détenteurs de droits externes. [Voir Informations légales.](#)

Terms of use

The ETH Library is the provider of the digitised journals. It does not own any copyrights to the journals and is not responsible for their content. The rights usually lie with the publishers or the external rights holders. [See Legal notice.](#)

Download PDF: 07.10.2024

ETH-Bibliothek Zürich, E-Periodica, <https://www.e-periodica.ch>

Leere Seite
Blank page
Page vide

Ocean Energy, Challenge for Structural Engineers

Energie des océans, défi pour les ingénieurs

Energie der Ozeane, eine Herausforderung für Ingenieure

Charles J VOS

Prof.
Delft Univ. of Technology
Delft, The Netherlands



Charles J Vos was trained in civil engineering at the universities of Delft (The Netherlands) and Leeds (United Kingdom). Since 1963 he is active in the design of heavy civil engineering structures, bridges, quay walls and concrete off-shore structures. Since 1982 he also teaches construction technology of concrete structures at Delft University of Technology.

SUMMARY

Ocean energy systems do encounter a new wave of interest because of their environmental advantages. They are interesting for civil engineers because of the multitude of physical actions encountered, like tides, temperature differences, waves and current. As sizes for commercial units are necessarily large, structural challenges are there to realize such options. The paper explains this with examples.

RÉSUMÉ

La production d'énergie à partir des océans attire à nouveau l'attention par son avantage considérable pour l'environnement. Les ingénieurs sont attirés par la complexité des actions diverses comme les courants de marée, les différences de température, les mouvements ondulatoires. Les dimensions d'un système sur une base commerciale sont tellement larges et compliquées que l'utilisation de l'énergie des océans est un défi permanent pour les ingénieurs. L'article est illustré par des exemples.

ZUSAMMENFASSUNG

Energiesysteme der Ozeane gewinnen aufgrund ihrer ökologischen Vorteile an Bedeutung. Für Bauingenieure sind sie hinsichtlich ihrer Vielzahl an physikalischen Wirkungen, wie Tide, Temperaturdifferenzen, Wellen und Strömung, von Interesse. Zudem verlangt eine wirtschaftliche Nutzung derart grosse Baueinheiten, dass ihre Realisierung auch konstruktiv eine Herausforderung darstellt. Der Artikel erläutert dies anhand von Beispielen.



1. OCEAN ENERGY SYSTEMS; HISTORY AND IMPORTANCE

Ocean Energy Systems are referred to as those ways of generating energy, using the potential energy being stored in the oceans. This energy has the characteristic that it is constantly renewed by the sun and its atmospheric effects. Ocean Energy can, therefore, be recovered for commercial use by retrieving it from temperature differences over the depths, or by using waves, swell, tide and tidal currents for energy generation.

Within most systems, three stages of development can be distinguished.

It is first the period that a certain system or physical principle was discovered and developed for demonstration or just publication in interested circles. Most of the present day developments are of older origin, but have new shapes because of new materials, equipment and actual requirements.

A second period of investigations and test, simultaneously now for all systems, started in the late seventies. The increasing prices on the worldmarket for hydrocarbons and instantaneous scarcities of supply, activated the raising of funds in many countries for research and development in ocean energy systems. The schedules raised in the USA, the UK and Japan, were followed by many countries, including countries like India and Indonesia. Most of these activities, however, decreased in volume and attention when the oil price dropped again in the beginning of the 80's. Funds for R&D were reduced and demonstration plants were stopped and cancelled, except for a few.

The present interest for Ocean Energy Systems is born by their potential environment friendly characteristics. This became important after the world became conscious of real long term threats from thermal energy plants in the late 80's. This effect was increased by the uncertain future of safe nuclear energy after the Tsjernobyl disaster in 1986. New schemes for renewable energy were started around the world. A clear example of that is the UK scheme within the so called "Non fossil fuel act", committing the government to install a certain amount of non fossil fuel power generation before the year 2000 and challenging free enterprise in the UK to propose ideas and schemes for actual realization and exploitation of such sources.

The approach within this third wave of interest for Ocean Energy Systems has not only different aims because it emphasizes environmental aspects. Because of the environmental approach, functional requirements regarding economy have changed into considering the increase of the effectiveness of conventional systems by using ocean energy systems complementary. This means that consideration of Ocean Energy Systems does not necessarily have to rule out all other systems at a certain location. They only have to contribute there, where they are effective in conjunction with other systems. For instance, an OTEC (Ocean Thermal Energy Conversion) Plant does not have to generate the energy for a complete island society, but may just be effective to provide cold water into the condensator of an air conditioning plant from a hotel and offices of that society.

The near future will offer many opportunities to explore such cases.

2. CHARACTERISTICS OF OCEAN ENERGY SYSTEMS

Ocean Energy Systems distinguish themselves from conventional thermal plants by the use of low temperature differences, low pressure heads and low velocities. This is generally true for OTEC (Ocean Thermal Energy Conversion), tidal power plants, wave generation units and PAC (Pump Accumulator Conversion).

As a consequence of these relatively low driving forces, the total flow has to be substantially larger. This makes Ocean Energy Systems quite attractive for civil engineers as the percentage of civil engineering works in a specific plant is far higher than for conventional units. This fact leads to a few other conclusions being encountered in several recent projects being under consideration.



- Ocean Energy Systems usually gain in efficiency by enlarging the scale. This can for instance be achieved by increasing flow and pressure. In case of a tidal power plant this means a careful selection of the site regarding the magnitude of the tide and the area of the reservoir. In case of a pump accumulation plant, it concerns the total height and the content and consequently the diameter of the reservoir.
- Ocean Energy Systems are usually complementary to existing energy systems. They further have side effects for the infrastructure. Such is for instance the case for a tidal power plant, offering a new fixed crossing across a basin as well. The consequence of this is, that such works require very careful strategy and planning with complex procedures with many more people involved.
- Ocean Energy Systems are unique projects, as they are custom made for specific geographical circumstances, such as bottom conditions, waterdepth, wave and current climate and other hydrological characteristics. This means that they require more time for planning and design than conventional plants.
- Because of their scale, they have usually a spectacular influence on the environment. This is not necessarily a negative one, but it requires anyhow a careful approach. In practice realization is more difficult.
- Because of the larger content of civil engineering structures in Ocean Energy System, the approach towards the mechanical and electrical components should be quite different, in order to achieve more effective results. Close joint development in between civil and mechanical engineers as in the time of the great Victorian engineers is required. Apart from that it can be stated that a large potential to improve such systems is present in mechanical components. These are objects like cheap heat exchangers from new and less costly materials and low pressure head turbines.

Last but not least it should be noticed, that the knowledge and experience required for the coastal and offshore aspects of Ocean Energy projects is in its presence limited to only a few countries in the world, where ideal conditions for such plants are in waters belonging to other countries. This makes Ocean Energy Systems to an ideal field of international cooperation in between civil and structural engineers.

3. SYSTEMS AND POTENTIAL OF OCEAN ENERGY

3.1 OTEC

The most imaginative and possible largest volume of ocean energy is thermal. The oceans act as an enormous heat buffer for a large portion of solar radiation that falls on the earth. About one quarter of the total of 1.7×10^{17} Watts of solar energy reaching the earth's atmosphere is absorbed by the seawater. Heating of the upper layers, leads to surface temperatures of 25°C and higher in tropical areas. When this surface water is used in combination with the cold water from the depth, being 4°C or slightly higher, an Ocean Thermal Energy Conversion plant can be made.

Many configurations are possible to achieve this "reversed refrigerator" principle, where a temperature difference generates energy, in stead of energy generating a temperature difference. The most common appearance is the so called closed cycle. In this case, illustrated in Fig.1, cold water is pumped up and used in a condenser to condense a closed cycle of ammonia. The ammonia



liquid is pumped to an evaporator where hot surface water evaporates the liquid into ammonia vapour. Before the ammonia vapour is condensed again, a turbine is placed in the circuit, driving a generator.

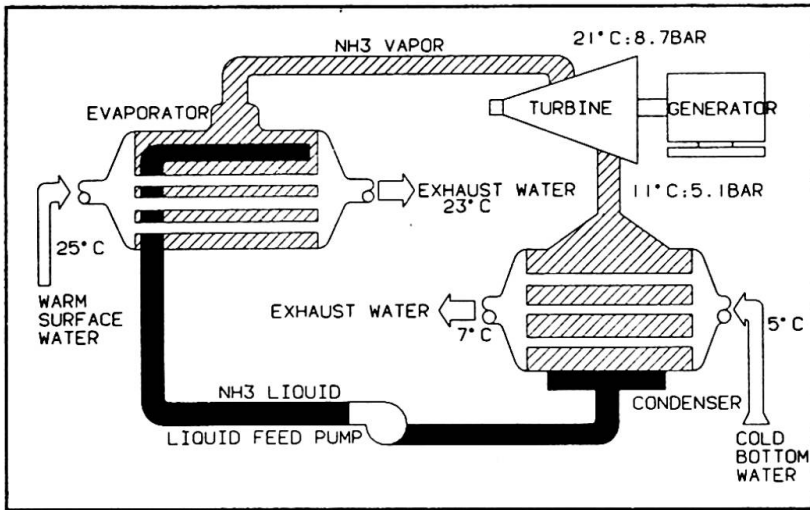

Fig.1 Scheme of closed cycle OTEC plant

The advantage of the OTEC system in comparison with for instance wave and tidal energy generation is that the temperature difference is continuous present. The disadvantage, however, is the large flow required for a commercial system. Estimating the efficiency for an OTEC plant on 1,2% with a temperature difference of 20°C, the production of 1 MW net will require flows through the station at a rate of 5 m³/sec for both warm and cold water. Such a station, running with a flow of 1 m/sec, would already require a diameter of 2.5 m for the cold water pipe

Looking into the near future option for OTEC, it is most likely, that land based plants will be realized on a commercial basis.

This means, that at a possible location, where the surface temperature is sufficiently high, the coast should drop over a relative small distance, say 1-2000 m to depths of over 800 m where water of sufficiently low temperature can be found. Such locations are present at many coasts in areas with sufficiently high seawater temperatures being shown in Fig.2.

Such is the case for instance at the Indonesian island of Bali and on some Caribbean islands, like Curacao.

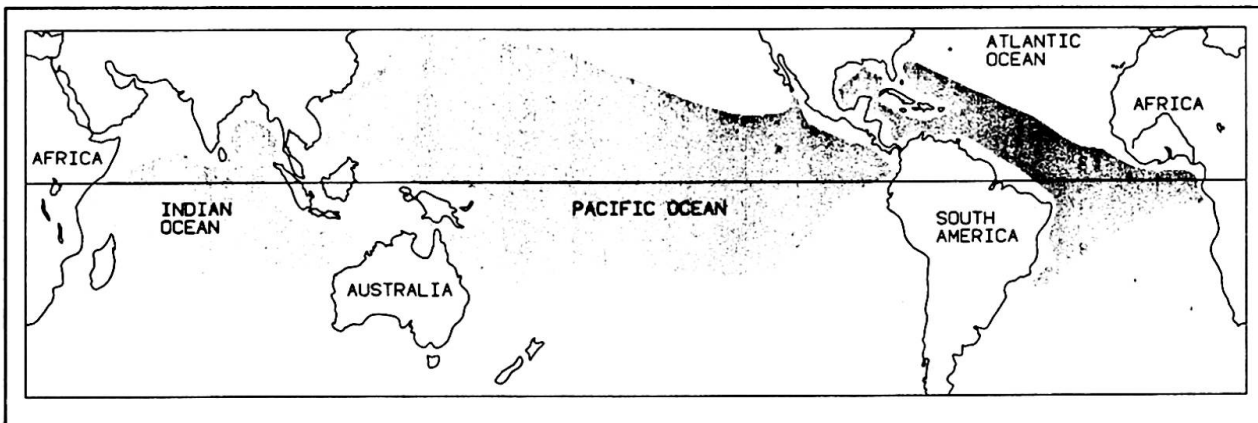

Fig.2 Areas in the world with OTEC potential.

The land based option saves the requirement of an exposed offshore vessel to support the electricity generation equipment as well as an exposed electricity cable through the Ocean towards the shore. These advantages will make a land based option ideal for small commercial applications, such as being proposed for Curaçao, where the costs for the airconditioning of a hotel can be reduced by figures like 70% and a pay back time on the investment of only 3 years. The principle of OTEC dates back to 1881 when the French scientist Jacques d'Arsonval put the idea forward as an application of the Rankine cycle. His pupil Georges Claude built the first generating station round 1930 at Matanzas Bay on Cuba. The station produced 22 kW of power for only two weeks before the cold water pipe was destroyed in a hurricane. Some other experiments were conducted, most failing again on the deployment of the cold waterpipe, until more frequent research and experiments were conducted from the mid seventies onwards.

Test plants were actually planned on many locations, including India, Indonesia and Abidjan, but only a few have actually been built. These are in offshore Hawaii and offshore the Japanese island of Naru. Many new experiments, research and development exercises and planned installations are under way.

3.2 Tidal energy

Although the principle of tidal energy is much more common to civil engineering practice as it compares with usual hydroplants, only two have been built and a few are being planned.

The absence of continuity in electricity generation due to the tide cycles and the required large scale of the principle may be the reasons for the absence of more units.

The French constructed the first tidal power plant in between 1961 and 1966 in the river La Rance in the province of Brittany.

The installed power is 320 MW and 550 GWh of electricity is produced annually. Seven percent of this output is due to so called pump accumulation. This means that during certain periods, when tides are favourable, but electricity consumption is low, energy from continuous operating electricity plants, like today the nuclear units, is used to increase the waterlevel in the reservoir in order to store more energy than the tide only would do, for consumption during hours of peak consumption. The La Rance reservoir has an area of 15 km².

One other tidal powerplant is operating at the Northern coast line of the Soviet Union.

Many other interesting locations on earth, with the required high level of tidal range and reservoir area are being studied. Amongst them are the Canadian Bay of Fundy, the Gulf of Kutch in the Indian state of Gujarat and the British Mersey Barrage in the river Mersey.

The influence a tidal barrier has on the environment around the reservoir is substantial. Currents and water tables change, ship traffic will at least encounter more sluices and the influence on the ecology is present. It is interesting to see, that in case of the Mersey Barrage project in the UK, being inspired by the "Non Fossil Fuel Obligation" integral cost are being evaluated. This takes into account the profit by less exhaust of 1.75 million tons of CO₂, no exhaust of sulfur and nitrogen-oxides, no remaining slags, a better quality of the water and an improved protection against high water.

In certain areas of the world tides are not significant because of their tidal range, but rather because of the current induced in a certain narrow sea strait. This is for instance the case in the area of the Channel islands in between France and the UK, In the Menai Straits and at Chindsudo of the coast of South Korea. Currents of up to 7 m/sec are characteristic for these locations. It is a challenge for mechanical and civil engineers to design reliable devices for the direct conversion of kinetic energy into electricity. Such devices are only of experimental character yet. When developed they could also



serve as energy generators on small scale in fast streaming rivers on land where no possibility exists for the creation of a water head by a dam.

3.3 Wave energy

Wave energy devices have been designed, tested and deployed as an experiment in a wide variety of shapes, mechanisms and capacities.

The reason for this may well be the low level of investment to obtain a demonstration plant, compared to OTEC and tidal devices. Nevertheless there is also much critic on wave energy devices. Some designers state that it is anyhow more efficient to obtain energy directly from the driving force of the waves, the wind, instead of recovering it from the waves. This may be quite feasible offshore. Consequently we see quite some areas in the world where on the beach, or close offshore windmill parks have been put into operation.

Regarding the wave energy projects, small scale test projects have been established, according a variety of physical principles. Devices where floaters are moving in the waves and introduce forces and consequentially forced movements relative to foundations in the seabed are considered as relative expensive, vulnerable to mechanical damage and delicate in maintenance.

Devices that transfer the wave movement into compression and decompression of air, that on its turn moves a turbine above sea level are more attractive regarding costs, possible mechanical damage and maintenance. A most interesting experimental unit has been deployed offshore the Tamil Nadu coast in south east India. Prof Raju from the Indian Institute of Technology in Madras reports on this feature in the Special session R2 on Offshore fixed and floating structures of this conference. A special feature in this project is the anticipation of using these units for breakwaters for new harbours in the area. In this way a substantial part of the costs of these units, i.e. the cost of the caissons and the installation of those, would not charge the investment in energy production. Figure 3 shows a cross section of this installation.

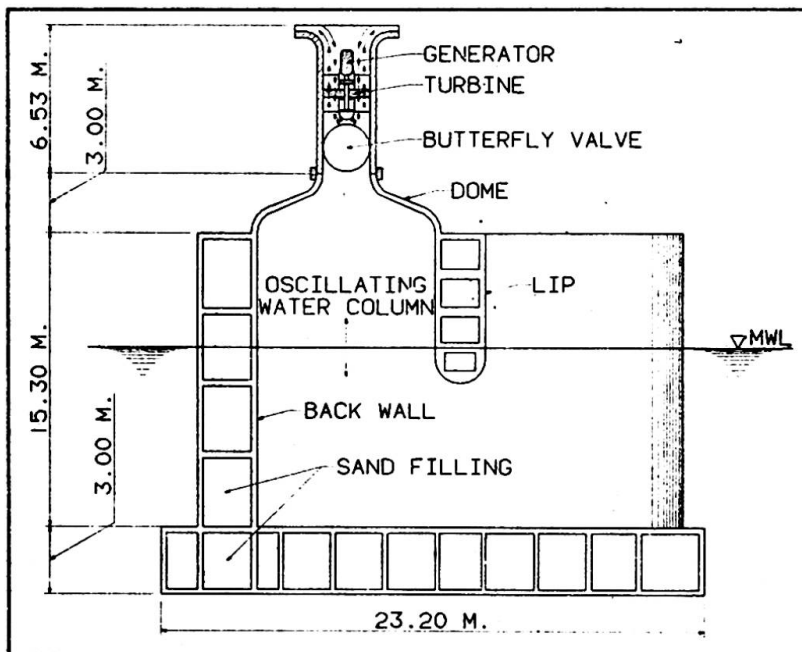

Fig.3 Experimental wave energy generator offshore Tamil Nadu

It may be true, that according these lines of cost sharing other wave energy projects may become feasible.

Wave energy projects have an other disadvantage. Waves are not permanent

present in many locations and vary in time. For this reason the number of locations are limited to those where a permanent ocean swell provides long waves with a high energy content. For such locations other mechanisms of energy generation are possibly feasible.

An artificial atoll is one of those options tested. Chapter 4 of this paper explains on an example.

An other option is tested in Norway. Long ocean waves are guided into a natural or artificial funnel. The wave height does increase by the funnel action. At the end of the funnel a dam is built. The waves, running into the funnel overtop the dam and feed a reservoir with a top level well above the medium sea level. In between the reservoir and the sea a channel with built in low head turbines are provided to generate electricity. This system is tested in Norway and may be deployed in Indonesia shortly.

3.4 Pump Accumulation Conversion

Already under tidal power generation PAC was mentioned. Although PAC is not strictly related to Ocean Energy Systems, it should be mentioned here, as quite some effort is being spent on studies for the development of pump accumulation basins in coastal areas.

The aim of such units, where energy is buffered by the conversion of kinetic energy in the form of electricity, into potential energy, by increasing the water level of a basin, is appreciated in different ways. See figure 4 for the basic principle.

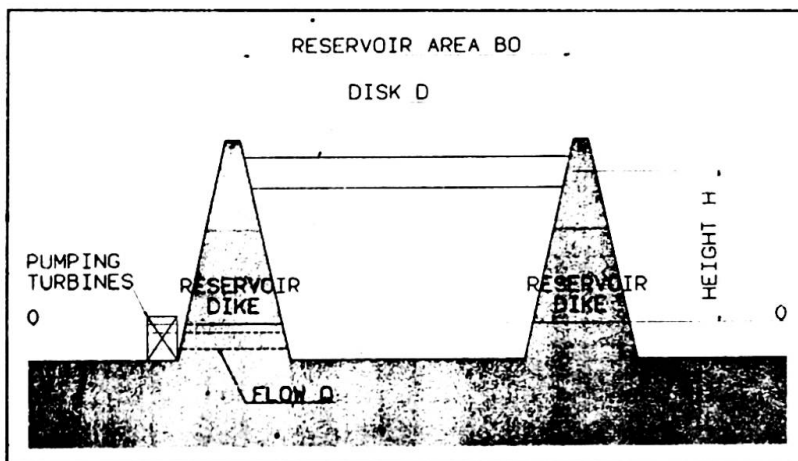

Fig.4 Principle of a PAC plant

In general it is a system to store energy from continuous sources, like nuclear power plants, for use during peak hours in energy consumption. But not just this approach is valid for the justification in the investment of PAC units. As conventional plants, like coal fired thermal units require an increasing investment, because of the necessary provisions for cleaning of exhaust gasses and deposit of slags, it may be more effective to run them on their full capacity and save the not instantaneous required energy in PAC units. Studies in The Netherlands have shown that benefit - cost ratio's are a function of net energy content and guaranteed output. This is demonstrated in an example in figure 5 for a location offshore The Netherlands.

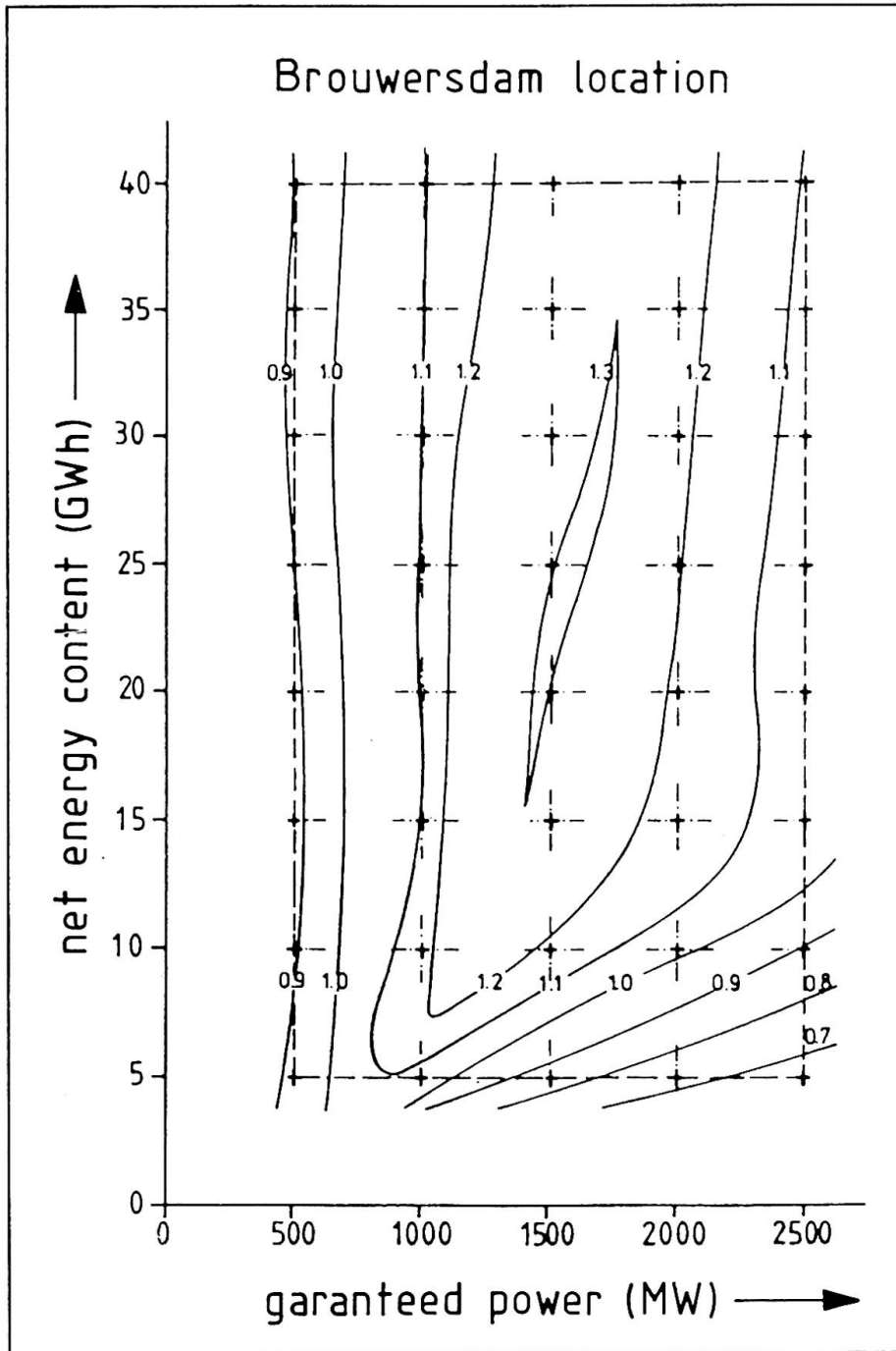

Fig.5 Lines of equal cost benefit ratio for an available pumping capacity of 2700 MW

Pump accumulation conversion systems have been constructed in many places in the world, usually there where natural conditions were favourable and civil engineering works on dams could be reduced to a minimum. Table 1 shows the main characteristics of some of those plants, indicating already, that the height of waterhead has to be considerable.

In case of the recent Dutch investigations mentioned, where no natural geographical gradients can be used and the entire plant has to be constructed offshore, 70 m. high dams with a 2700 MW capacity proved to be most effective.

Location	height (m)	power (MW)
0 Plate Taille - Belgium	47	135
0 Gabriel y Galan - Spain	59	110
0 Torrao - Portugal	52	74
0 Hiwassee - Tennessee, USA	63	76
0 Ludington - Michigan, USA	100	1842
0 Smith Mountain - Virginia, USA	58	108
0 Jocassee - South Carolina, USA	102	200
0 Midono - Japan	72	245
0 Mazegawa - Japan	100	288

Table 1. Examples of pump turbine plants

4. OCEAN ENERGY; CHALLENGES AND PROBLEMS

From the examples given in chapter 3 it is clear that Ocean Energy Systems are quite attractive in many ways. Apart from a promising option for environment friendly and consequentially effective energy, such systems represent a challenge for structural engineers.

Those interested in new shapes, new materials and new ways of construction, have a completely new field with many possibilities. Some examples of creative ideas are presented here.

The cold water pipe for a 400 MW capacity floating OTEC plant has been the subject of several constructability studies. A most interesting new idea, showing new shapes, new materials and new construction methods in just one concept was developed as shown in figure 6. The pipe has to be 30 m. diameter, with a length of 1000 m. to be deployed offshore on location.

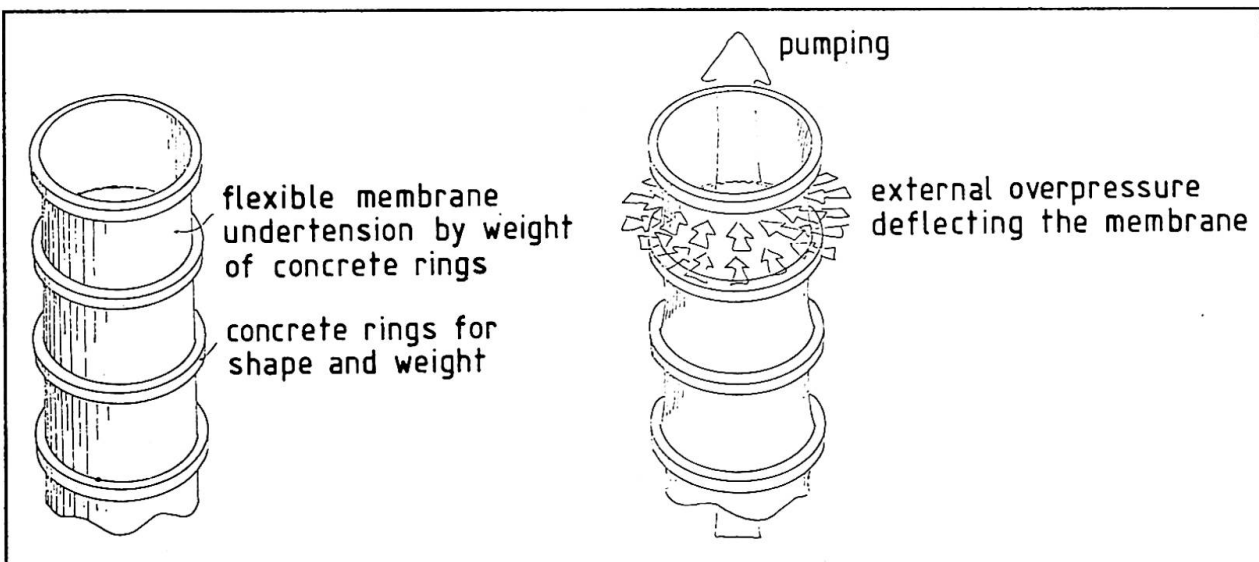

Fig.6 Flexible OTEC cold water pipe

The idea of this design is a composition of high strength fibre being kept in cylindrical shape by the weight and form of concrete stiffening rings. It is clear that such a system can be deployed sequentially, far more easy than a stiff construction, through the well of a floating body.

Another idea mentioned was the artificial dam atoll. Here long waves are used



to generate power by focusing the waves on an atoll type floating construction. Fig.7 shows the principles of a way of constructing such a unit.

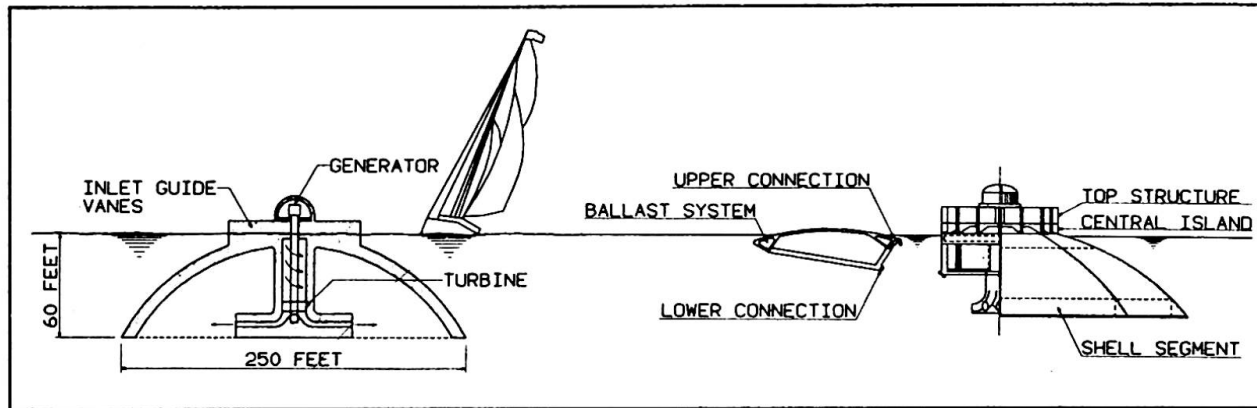

Fig.7 Dam atoll in place and under construction

It may be clear from these two examples that ocean energy systems have a challenge for the imagination of creative engineers. Other systems like the energy storage schemes, require dams on soft soil of magnitudes never encountered in the engineering history. Wave energy systems do invite for linking different functions of marine structures. Tidal energy systems require major civil engineering works that have to be completed in a relatively small time frame to allow for economic feasibility.

For structural engineers focused on analyses and modelling, rather than on creating shapes and systems, ocean energy systems have promising work in hand. What to think of flexible cold water pipes of substantial length and mass, being embedded in a floating structure, subject to waves and current. What to analyze about 80 m. high dams on soft soil for pump accumulation conversion systems. The emphasis of the day, analysis, is served with a wide variety of challenges focused on ocean energy systems.

Both challenging features, design and analyses, require an attention that is embedded in an environment of consciousness about engineering, environment and society. This involves a rather complex way of dealing with the problems.

This means that an engineering approach towards ocean energy systems requires design methodology and a scientific background for solving environmental engineering. Both requirements are presently badly represented in our structural engineering practise.

References

1. DOUGLAS, Carmichael A.; Ocean engineering power systems; MIT Se Grant Program NG 43 72, Cornell Maritime Press, Inc. Camebridge, Maryland 21613, February 1974.
2. POT, B.J.G. VAN DER, a.o.; Ocean Thermal Energy Conversion; Design of a demonstration unit for Bali, Indonesia. Land and Water International, vol. 55, 1985.



2. POT, B.J.G. VAN DER, a.o.; Ocean Thermal Energy Conversion; Design of a demonstration unit for Bali, Indonesia. Land and Water International, vol. 55, 1985.
3. VOS, Ch.J. Concrete for OTEC; pointers from experience and research. Proceedings; Concrete Ships and Floating Structures Convention. Thomas Reed Publication Ltd., Rotterdam, 1955.
4. CARR, G.R.; Studies of a tidal power barrage on the river Mersey. 3rd International Symposium on Wave, Tidal OTEC and Small Scale Hydro Energy: "Water for Energy", Brighton, England, May 1986 by BHRA.
5. BERNSTEIN L.B.; Tidal Electrical Powerplants. Leningrad 1988 (in Russian).
6. HORDEN, W.C., a.o.; Groundwater aspects of a pumped storage scheme; Ninth European Conference on Soil Mechanics and Foundation Engineering; Dublin, September 1987.

Leere Seite
Blank page
Page vide

Solar Thermal Electricity Generation

Production d'électricité par chaleur solaire

Die solar-thermische Elektrizitätserzeugung

Jörg SCHLAICH
Prof. Dr.
Univ. of Stuttgart
Stuttgart, Germany



Jörg Schlaich, Professor and Director of the Institut für Tragwerksentwurf und -konstruktion (Inst. for Structural Design), formerly called Institut für Massivbau (Inst. For Concrete Structures) at the University of Stuttgart and Consulting Engineer with Schlaich Bergemann und Partner, Stuttgart.

SUMMARY

Seven technologies are today considered to be able to share a future renewable energy electricity production. These are, in addition to water power plants, wind generators and photovoltaic cell arrays, four systems which directly utilize the sun's heat: the atmospheric power tower, also called solar chimney, and three systems using solar concentrators. After discussing the technological state of the art of these thermal systems, especially in view of Third World requirements, a more general discussion of the necessity of more research and development in the field of solar energy utilization follows.

RÉSUMÉ

Il existe aujourd'hui sept technologies considérées comme capable d'apporter une amélioration sérieuse à la production d'énergie électrique solaire. Hormis les centrales hydroélectriques, les éoliennes, et les cellules photovoltaïques, il s'agit de quatre systèmes qui exploitent la chaleur des rayonnements solaires: les cheminées d'énergie solaire ainsi que trois procédés à miroirs convergeants. L'avancement technologique de ces systèmes thermiques est décrit ici, pour aboutir d'une façon plus générale sur la nécessité d'un accroissement de l'utilisation de l'énergie solaire, compte tenu, en particulier, de la situation dans le Tiers Monde.

ZUSAMMENFASSUNG

Es gibt heute sieben Technologien, denen die Chance eingeräumt wird, einen ernsthaften Beitrag zur solaren Elektrizitätserzeugung leisten zu können. Dies sind neben den Wasser- und Windkraftanlagen und der Photovoltaik vier Systeme, die die Wärme der Sonnenstrahlung nutzen: die Aufwindkraftwerke und drei Systeme mit konzentrierenden Spiegeln. Der technische Stand dieser thermischen Systeme wird hier beschrieben, um dann noch allgemeiner die Notwendigkeit der verstärkten Sonnenenergienutzung, insbesondere im Hinblick auf die Situation in der Dritten Welt, zu erläutern.



1. STATE OF THE ART OF SOLAR THERMAL ELECTRICITY GENERATION

1.1 Atmospheric power towers or solar chimneys

In the solar chimney three well-known physical principles - the greenhouse effect, the chimney, and the turbine - are combined in a novel way (Fig. 1).

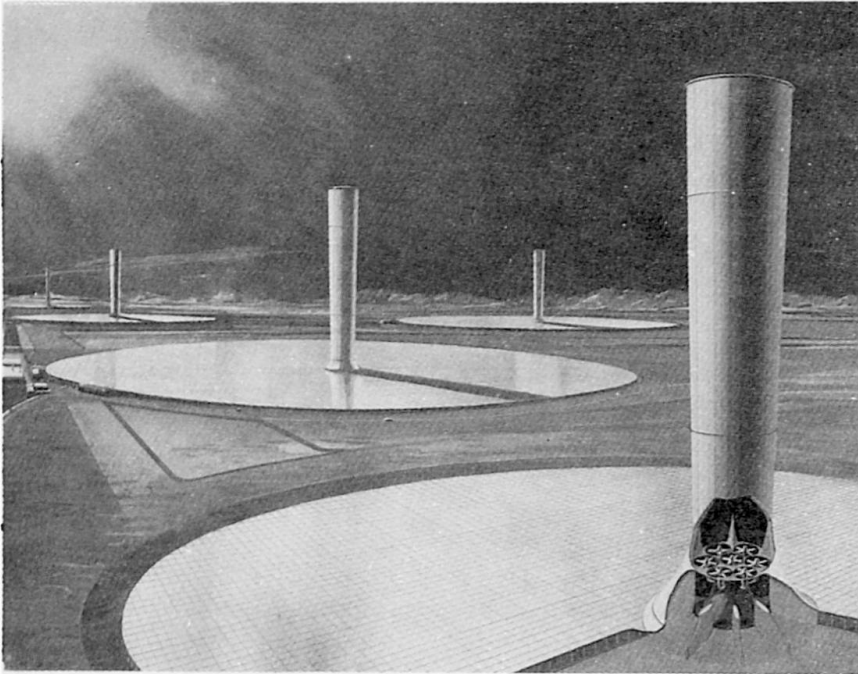

Fig. 1 Drawing of several large solar chimneys in the desert

Incident solar radiation heats the air under a large collector roof. The temperature difference causes a pressure drop over the height of the chimney resulting in an upwind which is converted into mechanical energy by a turbine and then into electricity via a conventional generator. This solar energy system has many technological and physical advantages:

1. It makes use of global radiation, including diffuse radiation when the sky is overcast.
2. The natural storage medium - the ground - guarantees operation at a constant rate until well into the hours of darkness (and throughout the night with large-scale installations).
3. Aside from the turbine and generator, there are no moving parts or parts that require intensive maintenance. No water is required to cool mechanical parts.
4. It features a simple, low-cost design utilizing know-how and materials that are also available in Third World countries (glass, concrete, steel). A high proportion of the costs is accounted for by work that is simple. This would benefit the local labour market while at the same time helping to keep overall costs down.

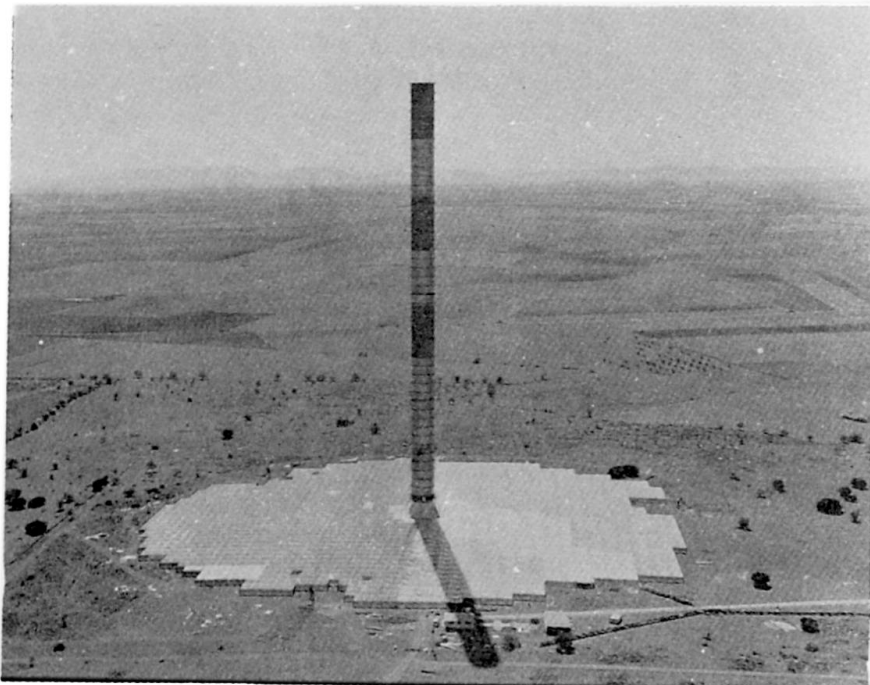

Fig. 2 Aerial photograph of the experimental facility at Manzanares, Spain (height of chimney 200 m; chimney radius 5 m; collector 120/120 m; rotor diameter 10 m; nominal speed 100 rpm)

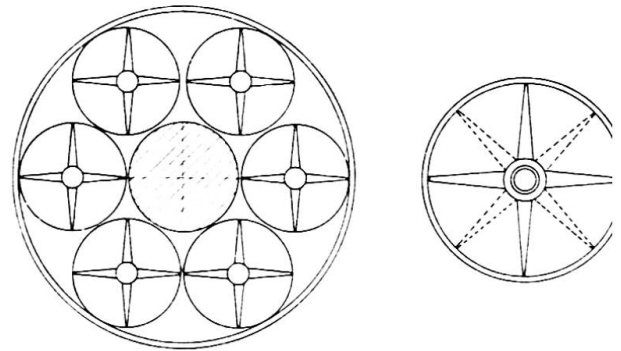
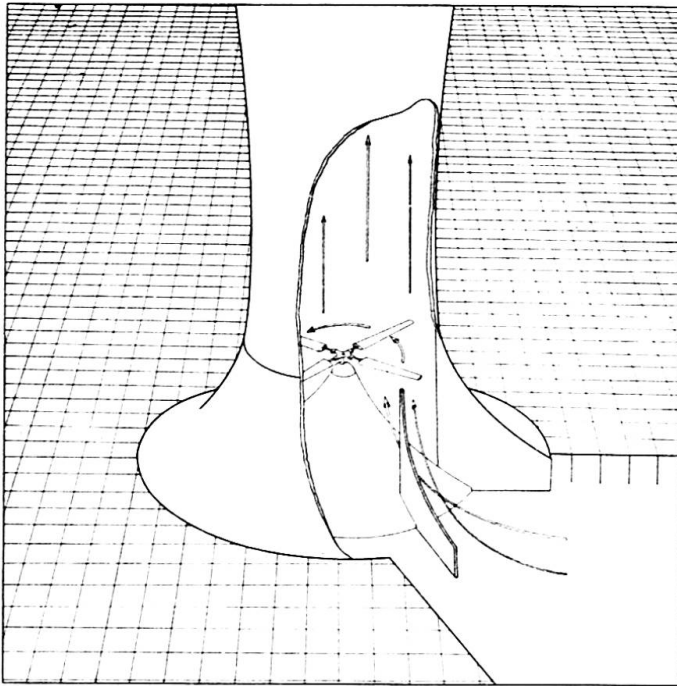

Fig. 3 While smaller units can operate with a single wind turbine, larger power plants would work better with several turbines. During operation, automatically controlled setting gears adjust the blades to their optimal face-impact angle.

With assistance from the German Federal Ministry for Research and Technology, an experimental facility was developed and built in Manzanares, Spain (Fig. 2), where these advantages were documented by a high degree of availability of the plant and low operating and maintenance costs.

Fig. 4 shows the hours of daily service for a full operating year. To permit a comparison, the measured hours of sunshine with over 150 W/m^2 irradiation and the theoretically possible maximum number of hours of sunshine (from sunrise to sundown) are also shown. The analysis revealed that, for example, in 1987 the plant was in operation for a total of 3197 hours, which corresponds to a mean daily operating time of 8.8 hours. As soon as the air velocity in the chimney exceeds 2.5 m/sec , the plant starts up automatically and is automatically connected to the public grid.

These results show that the components are highly dependable and that the plant as a whole is capable of highly reliable operation. The thermodynamic inertia is a characteristic feature of the system, even abrupt fluctuations in energy supply are effectively cushioned. The plant operated continuously even on cloudy days, albeit at reduced output.

Using a thermodynamic simulation program, the theoretical performance of the plant was calculated and the results compared with the measurements obtained, showing that there is good agreement. Overall, it may be said that the optical and thermodynamical processes in a solar chimney are well understood and that models have attained a degree of maturity that accurately reproduces plant behaviour under given meteorological conditions.

Extrapolation of these results to larger plants produces the results summarized in Fig. 5. It shows the energy costs as a function of the size of the plant, expressed by the 24 hr-average power output. The height of the chimney (first figure) and the approximate diameter of the collector roof are given along the curves. Further parameters are the climate of location, where Almeria, Spain, with approx. 2100 kW hr/yr and Barstow, California, with approx. 2600 kW hr/yr are compared, because of these two places all meteorological data are available. With the same plant specifications, for example, a chimney height of

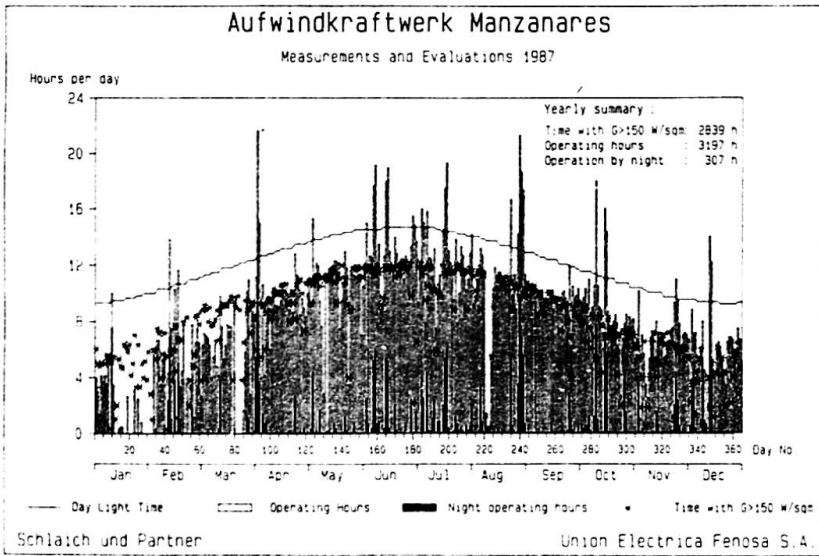

Fig. 4 Plant operating hours for 1987 of the solar chimney in Manzanares, Spain

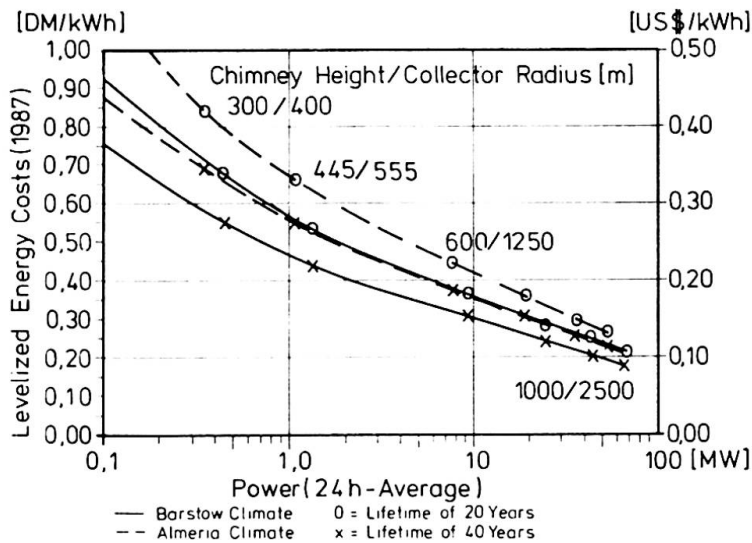

Fig. 5 Solar chimneys's electricity generating costs in relation to mean installed power

1.2 Distributed collector systems (DCS) with trough concentrators

The individual collectors are parabolic troughs, each 100 metres long and 6 metres wide, which are made from hundreds of curved mirror segments. These troughs are suspended in such a way that they track the sun, however around one axis only. The solar radiation bundles on a glass/metal tube placed along the focal line of the trough. This tube transports a heat transfer medium, at pre-

445 m and collector radius of 555 m, it would generate approximately 7.1 kW hr/yr under Almeria conditions, and 11.6 kW hr/yr, that is approximately 38 % more, in a climate such as that in Barstow, California. The calculations were based on a chimney life of 20 years; purely theoretically, therefore, the roof and machinery could be replaced in the twenty-first year. The specific electricity generating costs were calculated by the real present value method (with a real discount rate of 4% and a depreciation period of 20 or 40 years).

The economy of the power plant is dictated by the investment necessary to construct the plant and operating costs; these comprise personnel costs, maintenance and repair costs, and the cost of the necessary fuel. The calculations show that this power station technology, based on a renewable form of energy, satisfies every precondition for continuing development: technically feasible potential combined with power generating costs that, conservatively estimated, will be below \$ 0.10/kW hr.

sent a synthetic oil but in future possibly just water steam. This medium is collected and transferred to a conventional steam power plant consisting of heat exchangers, turbine generator, and a cooling tower.

These collectors have meanwhile reached, following from continuous improvements, a concentration factor of 82. Starting 1984 up to now six plants of 30 MW output each and one with 80 MW have been successfully built in California. In case of scarce of solar radiation gas firing may be added. This permits to avoid the costly thermal storage and guarantees continuous electricity supply, a requirement utilities certainly appreciate and pay for correspondingly.

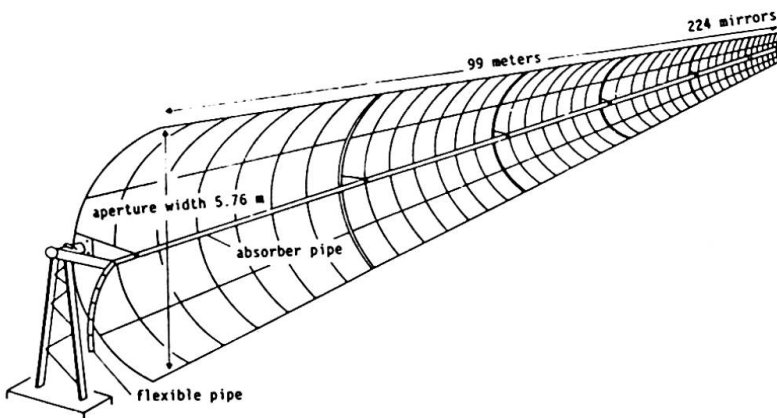

Fig. 6 Sketch of the LS-3-Collectors as built by Luz International Ltd. and Flachglas-Solartechnik GmbH

The 80 MW SEGS-plant (SEGS stands for Solar Electricity Generating System) was built in 1989 at Harper Lake in the Mojave desert where the sun shines 350 days a year. Its collectors amount to 464,000 m² and the heat transferring thermo oil is heated up to 393° C. The yearly energy production is 249,000 MW hr. The investment costs are about 2500.-- \$/kW and the energy production costs are given to be 0.08 \$/kW hr.

Thanks to a relatively simple technology and a skillful marketing the DCS trough collector plants are rather successful and have demonstrated that a large-scale solar energy utilization must not mean an utopia and that economy can be reached through mass production. In regions with a high direct solar radiation these plants have a promising future.

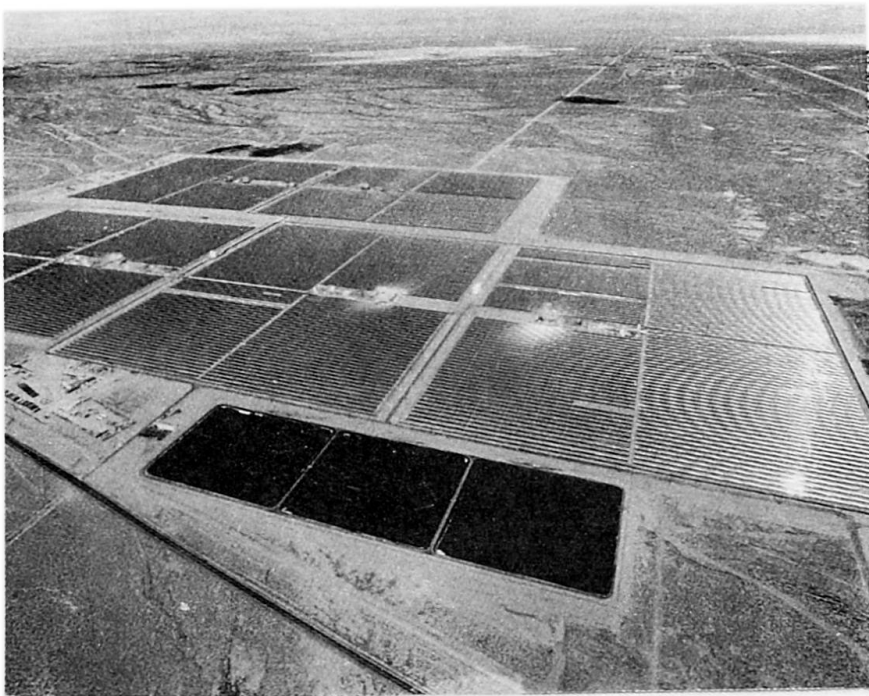

Fig. 7 The DCS plant at Kramer junction, USA (5 x 30 MW)



1.3 Central receiver systems (CRS), solar tower plants

The central receiver is placed on a tower, between 50 and 150 metres above ground. On ground around this tower the field of heliostats is arranged, heliostats in this case being the name for the concentrators or mirrors. The solar radiation is reflected by these heliostats to the receiver heating up a heat transfer medium there. Beyond that, as with the DCS, there is conventional thermal power plant technology: The medium is brought by pipes to a power plant at the base of the tower and drives there a turbine coupled with a generator.

The heat transfer medium may be air, water steam, liquid sodium or melted salt, and correspondingly the process temperatures vary from 550° to 1000° C. Each heliostat consists of several individual mirrors which are all together mounted on a structure able to track the sun around two axes. The tracking is computer controlled to guarantee a precise focusation. Up to now six such plants were built in the United States, in Southern Europe and Japan, the largest being the 10 MW plant at Barstow, California (Fig. 8) using steam as heat transfer medium.

Further development is to be concentrated on system integration and cost reduction of the individual components. The receiver plus heat transfer and short-time storage make up 1/4, the heliostats 1/3 of the total plant costs. It is expected that the efficiency can be considerably improved and the whole system simplified by applying high-temperature air receivers.

Concerning the heliostats, the accuracy and the robustness of the tracking device need improvements and the costs must be reduced. The metal membrane concentrators, as shown in section 1.4 are very well adaptable to heliostats, too, and would easily fulfill these requirements.

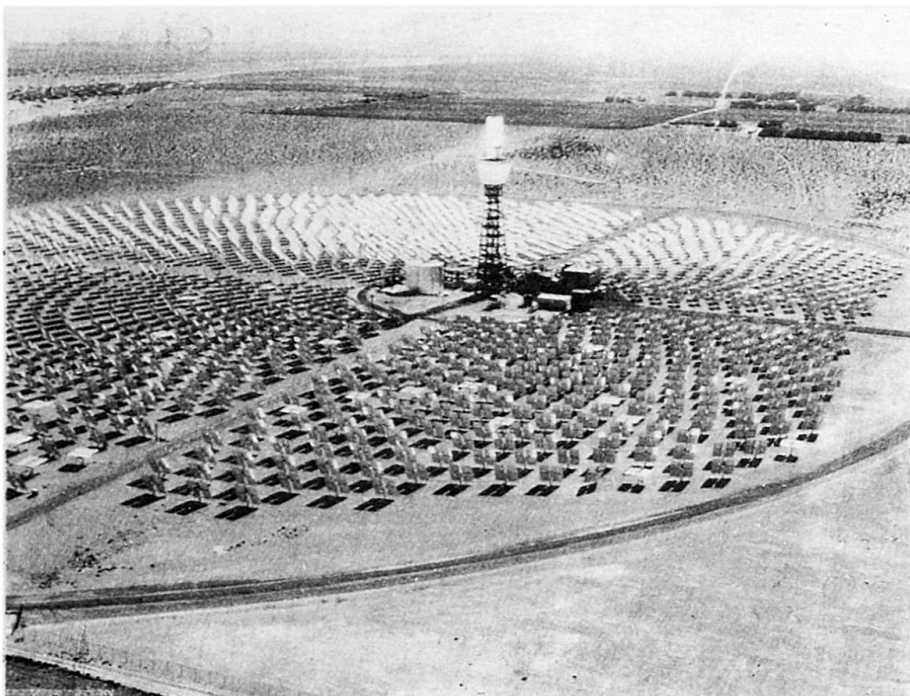

Fig. 8 The CRS plant Solar One at Barstow, California (10 MW)

1.4 Dish (metal membrane)/Stirling decentral electricity plants

As a means of generating electricity from solar energy, high-temperature energy conversion with concentrating systems has a very promising future.

A large hollow reflector is suspended in such a way that it can track the sun. The reflector has an energy converter, which converts the concentrated solar heat into electricity, suspended at its focal point.

The new and special feature of the power plant described here is the construction method, which makes a very large and precise concentrator possible. The concentrator is a hollow membrane of thin sheet steel to which mirror glass is bonded. The membrane is plastically deformed to the desired parabolic shape by air pressure. When the concentrator is in operation the shape of the membrane is kept constant by a partial vacuum in the interior of the concentrator, i.e. between the reflector membrane, the rear membrane and the reflector ring (Fig. 12).

The energy conversion system (ECS) consists of a Stirling engine with a receiver located at the focal point of the reflector; the reflected solar rays heat the working gas (hydrogen) of the engine. This is a generator coupled directly to the engine.

Since each unit is capable of fully independent operation, as many concentrators as desired can be operated in conjunction, according to requirements. They can be operated both in grid connection mode or "stand-alone" mode. Storage devices (batteries, pumped storage etc.) may be provided or a hybrid conversion in combination with gas.

Power plants with reflector membranes are capable of an overall efficiency (defined as the ratio of the output usable electricity to the solar irradiation over the reflector surface) of up to 27 %. This has never been achieved with other types of solar plants. As the membrane construction method used for the reflector is relatively inexpensive they also make economic electricity generation a real possibility. The output of the energy converter depends on the accuracy of the beam path. The reflector membrane satisfies this requirement, though only a simple technology is needed for its fabrication. With carefully planned technology transfer such power plants could therefore also be fabricated in the low-income countries of the Third World.

In 1985, after constructing a test facility in Germany, two concentrators with 17 m diameter were installed in Saudi Arabia (co-sponsored by the King Abdul Aziz City for Science and Technology in Riyadh), (Fig. 9). Their power output is 50 kWe each. After the "usual" initial problems, especially with the Stirling engines, both are now continuously operating according to expectations.

With the experience such gained, a further step of development was started in 1987 with the goal to develop a smaller size and extremely robust plant for installation at remote farms or other remote places and for operation by its unskilled owner. With a 7.5 m diameter the power output is 9 kWe.

This concentrator is polar mounted with one axis parallel to the earth's center of rotation. Thus, tracking of the sun may occur at an almost constant speed of 15 degrees/hr which can be achieved without electronic aid but only by means of a clock. Along the second axis the necessary adjustment is prescribed by the ecliptic of the earth; due to its very small daily changes it can be operated discontinuously and manually.

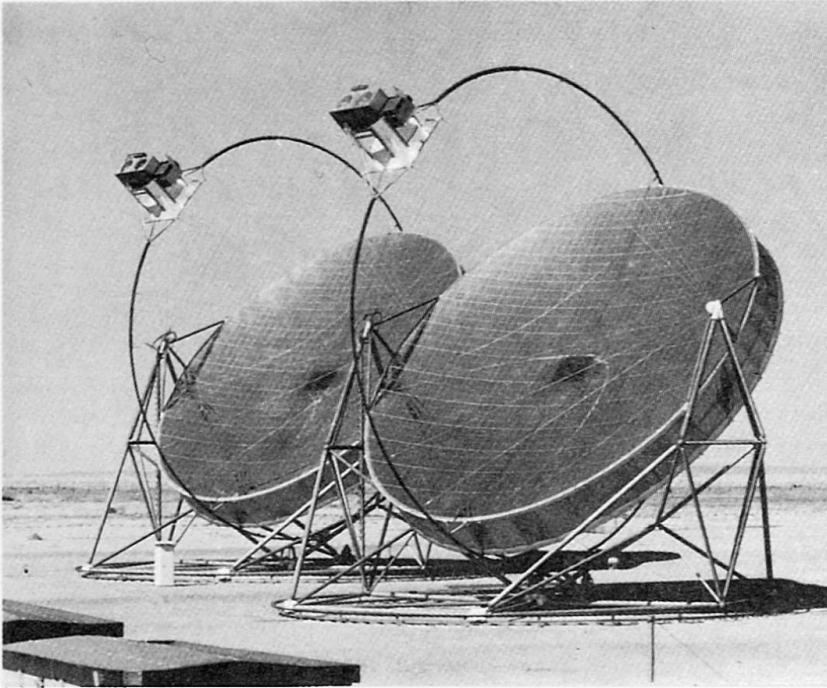

Fig. 9 Two 50 kWe concentrators in Riyadh

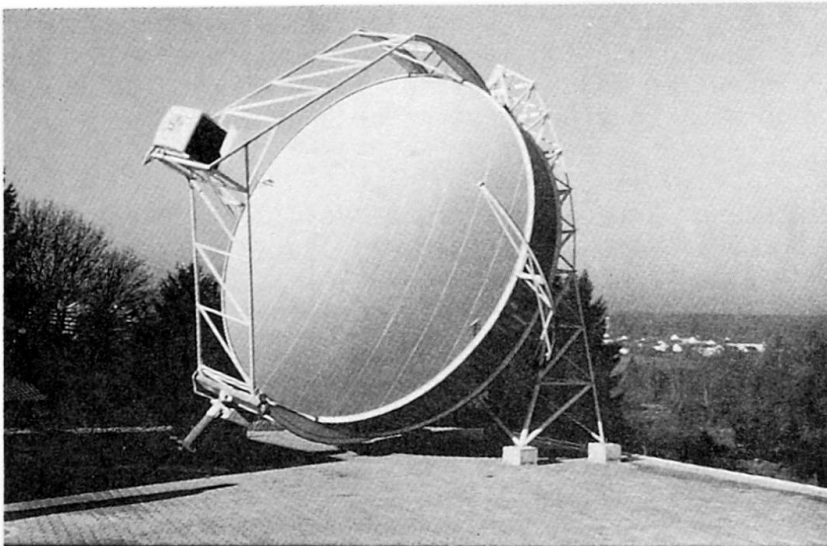

Fig. 10 9 kWe concentrator in Stuttgart

A test facility of that sort is now operating in Stuttgart. The quality of its concentrator is extremely good since a concentration factor of at least 10,000 was measured (Fig. 10). Thus the main aim of future development must be to build Stirling engines in series. It is also intended to reach a 24 hours operation of such plants by combining it with a biogas installation. Finally it should be mentioned that such metal membrane concentrators are also capable to make extremely precise and economical heliostats for the so-called solar towers (sect. 1.3).

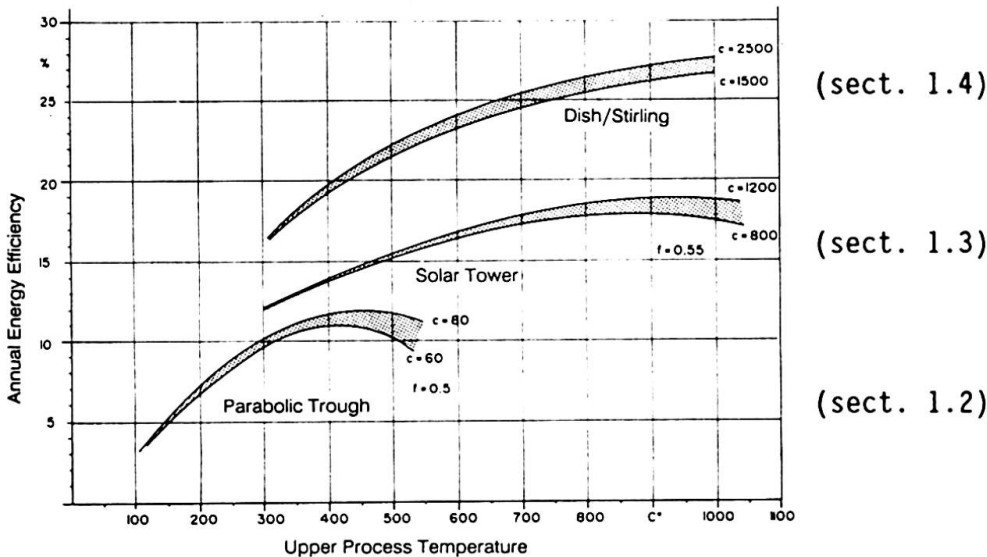
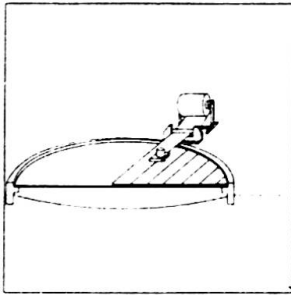
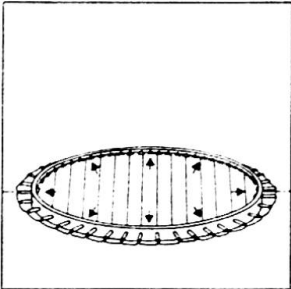

Fig. 11 Overall efficiency of concentrating systems



The membranes are made of individual sheet-metal strips welded together in the same plane with a welding device specially developed for thin sheet metal, which insures a gastight seam.



They are fixed to a ring and stretched radially until flat.

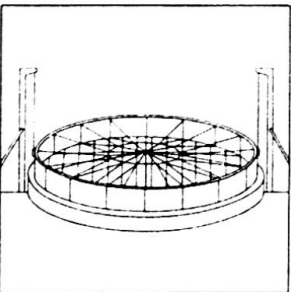

After fixing the rear membrane to the ring the concentrator is turned over.

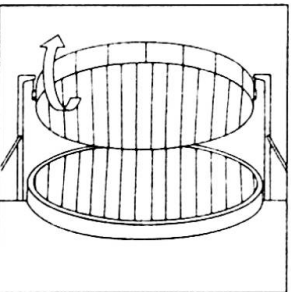

The front membrane is then deformed to a paraboloid by applying air pressure between the membrane and the ground and subsequently fixed to the ring.

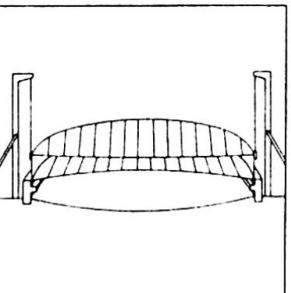

Now the air can be extracted from the concentrator housing thus created; with a partial vacuum between them the membrane surfaces will also withstand high wind loads.

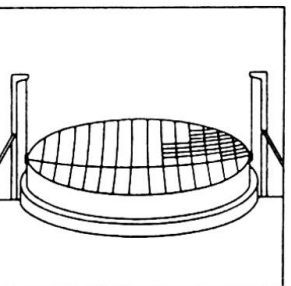

Finally, thin glass mirrors are bonded onto the front membrane.

Fig. 12 Fabrication of the concentrator housing



1.5 Summary and cost comparison

Especially the solar chimney (sect. 1.1) and the trough-DCS-systems (sect. 1.2) are feasible for large-scale solar electricity production, whereas the CRS-tower plants need further verification first. Since the solar chimney's investment respectively construction costs depend on labour predominantly, it becomes superior to any other system in places where labour is cheap.

For the decentral application the dish/Stirling-system should be further developed because they have a chance to serve the same purpose in sunny places as the wind converters in windy regions, where the latter are already today economical.

The graph in Fig. 13 compares all seven technologies at suitable locations with respect to their electricity production costs. Without hesitating it can be said that already today solar electricity can be produced for less than \$ 0.1/kW hr. This is economical if one considers that this price does not depend on fuel and comprises all environmental costs.

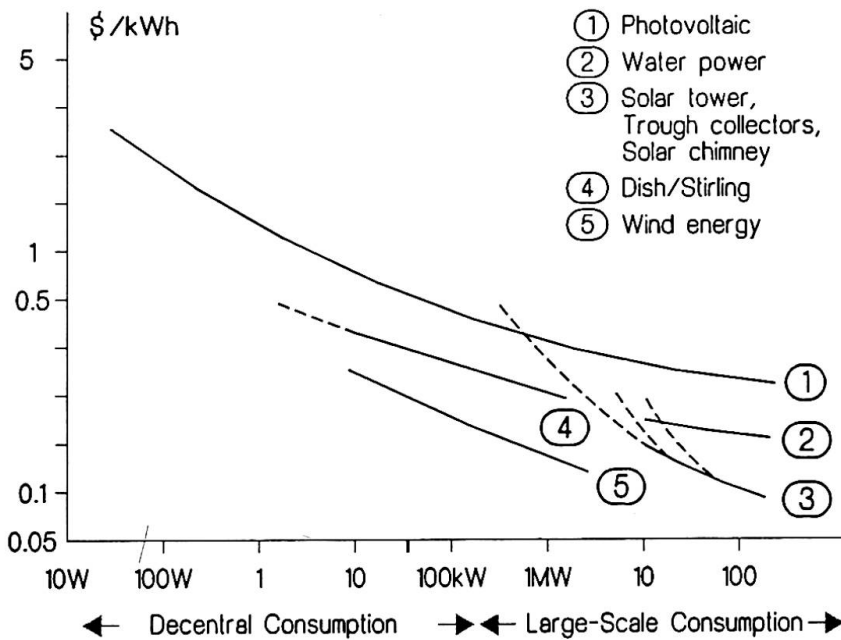

Fig. 13 Electricity production costs of the relevant renewable energy technologies



2. WHY AND WHERE SOLAR ENERGY UTILIZATION?

We are facing the greatest materials problem in the history of mankind, that of keeping this earth habitable and viable. The threats are

- a population explosion accompanied by poverty and undignified living conditions in large parts of the world
- the reckless exploitation and imminent exhaustion of our natural resources
- as a consequence of the above, the destruction of our natural environment.

Do we have to fear that our political leaders will not foresee this global threat and further that they will not have a clear concept of the consequences? Should not only those deserve our trust and our votes who commit themselves to the people and their interest; who purposefully and consistently pursue the "north-south dialog" and who work to develop a concept for a new global responsibility?

It would be presumptuous to try to present such a concept here. The social, cultural, economic and political implications in the creation of a new global responsibility are far too complex and intricate. A prudent agenda would have to include manifold solutions tailored specifically to each society or segments of society, from measures to combat illiteracy and promote the emancipation of women, to moving away from the traditional forms of national sovereignty and obsolete nation-state thinking.

However, beyond any doubt, the emphatic development of renewable energy sources would be a tangible and promising beginning, creating jobs here and relieving the drain on natural resources and harm to the environment. All we need is to react sharply and move promptly before it is too late!

Obviously the threat to our planet grows progressively with the number of people it houses. Slowing down population growth can help reduce degradation of the earth's environment and relieve some of the plight of the people. Of course, predictions about the future development of the world's population differ greatly. However, all agree that the population increase in the developing world will be significantly reduced in the next century as a result of factors similar to those we have experienced in industrialised societies, and will finally come to a standstill once a population of some 10 to 12 billion has been reached. Wishful thinking? In fact, a high birth rate is directly correlated to a low standard of living and the latter, respectively the productivity of a country, is directly proportional to the energy consumption (Fig. 14).

By no means should we encourage the Third World countries into a development that is as energy greedy as ours or rationalise such development solely by the relationship between energy consumption, living standard, and number of children. Yet, it would be self-deception to promote an end to the population explosion in the foreseeable future without also planning to raise those people's standard of living and, at the same time, providing the required increase in output of energy. If it is already difficult to predict the future world's population increase, it is even more difficult to predict the future energy demand and its regional distribution.

Table 1 represents a speculation of the author and permits the reader to put in his own figures. The left side registers the present situation: 26% of the world's population consume 76% of the energy! The per capita consumption in the developing countries is only a fraction of what is wasted in the rich countries. On the right side of the table it is first assumed that the world's population of today approx. 5 billion (in fact already 5.5) will double (as last time) within 35 years and amount to 10 billion with a regional distribution,



i.e. more in the D- and less in the I-countries. It is further assumed that the D-countries will receive a certain increase in energy per capita, enough to increase their standard of living "sufficiently" and that the I-countries are able and willing to compensate that increase completely by savings such that the average per capita consumption remains the same as today, i.e. 2.0 kW per capita, an extremely optimistic assumption! So the duplication of the population from 5 to 10 billion results in a duplication of the consumption from 10 to 20 Terawattyears/year only! But even then - and that is the problem! - the developing countries increase their consumption from 2.41 TW (today) to 13.1 TW (in 35 years), i.e. almost by a factor of 6! Then the D-countries, though their per capita consumption is still much less than that of the I-countries, will provide 84% of the world's population and require 66% of the total energy production.

How to satisfy this giant future energy demand at least necessary to break out of this vicious circle of population explosion, poverty, and environmental destruction? It got to be an energy source that is inexhaustible, environmentally sound, available everywhere, and that everyone can afford. Since neither fossil fuel nor nuclear energy can presently fulfil these needs on a global basis, only the direct use of the sun in the earth's desert areas offers a realistic source for the expected energy demand. This is why it is a paramount obligation also to structural engineers to participate in the development of solar energy power plants. It is beyond that up to each citizen of this world to propagate the idea of an increased solar energy utilization and to urge his political representatives to give financial priority for R+D in this field.

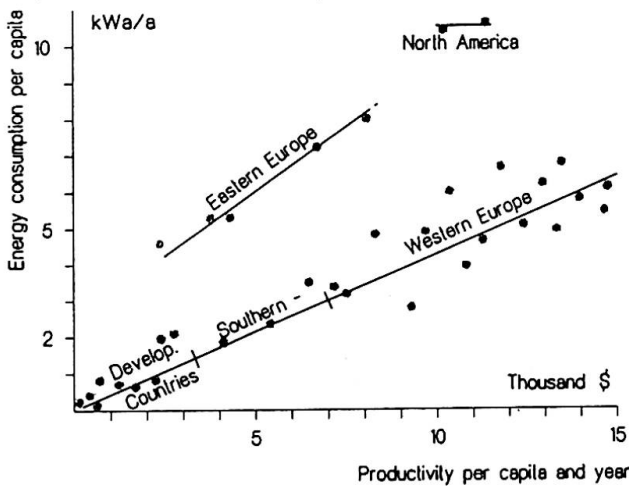

Fig. 14 Energy consumption per capita as a function of regional productivity

		Today				After about 35 years							
		Population		Consumption		Population			Consumption				
		Mill.	Σ/‰	kW/cap.	TW	Σ/‰	Mill.	Factor	Σ/‰	kW/cap.	Factor	TW	Σ/‰
Ind. countries (I)	North America	260	1310/26	11.20	2.91	7.59/76	313	1.20	1643/16	8.18	0.73	2.56	6.9/34
	Other western ind. countries	620		4.20	2.60		750	1.20		3.07		2.30	
	Soviet Union, Eastern Europe	430		4.80	2.08		580	1.35		3.50		2.03	
Developing countries (D)	Latin America	400	3690/74	1.60	0.64	2.41/24	1130	2.80	8360/84	2.00	1.25	2.26	13.1/66
	Middle East, North Africa	190		1.20	0.23		460	2.40		2.00	1.67	0.92	
	China, Asian soc. countries	1000		0.64	0.64		1600	1.60		2.00	3.13	3.20	
	South Asia, Africa	2100		0.43	0.90		5170	2.46		1.30	3.02	6.72	
		5 Bil		φ 2.0	10 TW		10 Bil			φ 2.0		20 TW	

Table 1 Scenario of the regional increase of energy consumption

Bending Frequencies of HAWECs Towers

Résonance à la flexion des mâts de rotors éoliens

Biegeeigenfrequenzen von Windrotor-Masten

N. GOPALAKRISHNAN

Scientist
Struct. Eng. Res. Centre
Madras, India

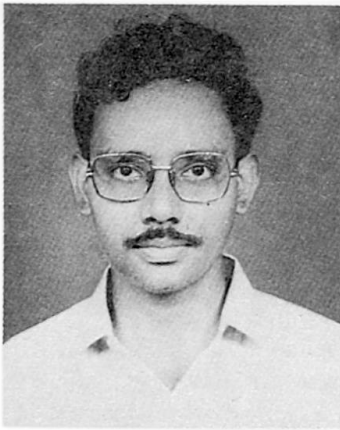

N. Gopalakrishnan received his M.Tech. in Structural Engineering from Indian Institute of Technology, Madras, in 1986. After a short stint at Tata Consulting Engineers, Bangalore, he is now working as a Scientist in Structural Engineering Research Centre, Madras.

R. RADHAKRISHNAN

Prof.
Indian Inst. of Technol.
Madras, India

Mr. R. Radhakrishnan, Professor and Head of the Dep. of Struct. Eng. at the Indian Inst. of Technology, Madras. He has guided a large number of research students and published a number of research papers. He is well-known in the areas of Structural Dynamics and Stability of Structures.

S.G. VOMBATKERE

Dr.
Indian Inst. of Technol.
Madras, India

Dr. S.G. Vombatkere, received his Ph.D in Structural Engineering from Indian Inst. of Technology, Madras, in 1987. He is a Colonel in the Indian Army. He is a Guinness world record holder for constructing the world's highest altitude bridge.

SUMMARY

A Horizontal Axis Wind Energy Conversion System is a fixed frequency operating machine. It should be designed in such a way that at least the first two natural frequencies are tuned with respect to the operating frequency. The parameters affecting the bending frequency are chosen to cover the entire range of the guyed and free-standing towers. Rayleigh's energy function for the first mode is also given in the paper.

RÉSUMÉ

Les rotors éoliens à axe horizontal, servant à la transformation d'énergie éolienne en énergie électrique, fonctionnent à vitesse constante. Il faut les concevoir de telle sorte que les deux premières fréquences naturelles de résonance de la structure porteuse soient différentes de la fréquence de résonance. Les paramètres influant sur la résonance à flexion sont choisis pour couvrir complètement la plage allant des mâts haubanés jusqu'à ceux entièrement libres, en adoptant les quotients de Rayleigh pour la première forme propre.

ZUSAMMENFASSUNG

Windrotoren mit Horizontalachse zur Stromerzeugung werden bei konstanter Drehzahl betrieben. Sie sollten so entworfen werden, dass zumindest die zwei untersten Eigenfrequenzen des Tragwerks nicht in der Nähe der Drehzahl liegen. Die für die Biegeeigenfrequenz massgebenden Parameter werden für den Bereich von abgespannten bis zu freistehenden Masten untersucht, unter Verwendung des Rayleigh-Quotienten für die erste Eigenform.



1. INTRODUCTION

The spiralling increase in the price of coal and petroleum, their depletable nature, and the pollution hazards caused thereby, make nations look for alternative sources for energy. High initial cost/KWH, high maintenance cost, and the waste disposal problems make nuclear and thermal power plants less economical in rural areas, where power consumption is relatively smaller. Wind power will provide the best solution in these circumstances with the least maintenance problem.

2. WIND ENERGY CONVERSION SYSTEM (WECS)

The principal components of a Horizontal Axis Wind Energy Conversion System (HAWECS) are the rotor, the blades and the alternator housed inside the nacelle, capable of freely yawing about a vertical axis. Nacelle is mounted on the top of the tower. The rotor imbalance and the momentary passage of the blades through the wind shadow region cause a dynamic excitation of the tower with forcing frequencies equal to $1 \times \text{RPM}$ and $N \times \text{RPM}$, respectively ($N = \text{Number of blades}$). Hence, it becomes imperative to detune the natural frequencies of a tower away from both the forcing frequencies.

A tower can either be guyed or free standing. Some of the famous guyed wind mill towers in the world are the Kuriant (15 KW) and the Jydsk VindKraft (15 KW) Wind mills in Denmark, the Sokol (15.2 KW) Wind generator in USSR and the Brummer, Bowe and Hullman (all 10 KW) wind generators in Germany. Growian I and II (3 and 5 MW) in Germany, The Volund (0.25 MW) in Denmark and the Andreau-Enfield (0.1 MW) aerogenerator in Algeria are examples of high power guyed wind power systems [1]. Guying renders a tower economical as the tower can be of smaller section. But it induces non-linearity due to the sag of the cables and also due to the reduced axial stiffness of the tower. However, in cases where the guy tension (T) is considerably more than the self weight (W) of the cable, the stiffness can be linearised by the Davenport's approximation [2].

$$k = K \left[1 + \frac{W^2 S^3 K}{12 T^3} \right] \quad \dots (1)$$

T = Average Guy Tension, W = weight/unit length of cable, S = Chord length, K = Stiffness assuming the cable as a truss member, k = Effective stiffness

The commonly used tower/guy configurations are shown in Fig.1. Fig.1(a) and Fig.1(b) are the plan views of typical guy configurations and Fig.1(c), Fig.1(d), and Fig.1(e) are the typical tower configurations used. It can be easily proved that for guy systems in Fig.1(a) and Fig.1(b), the stiffness can be given by

$$k_{11} = k_{22} = x k, \quad [x = 1.5 \text{ FOR FIG.1(a) AND } 2.0 \text{ FOR FIG.1(b)}] \quad \dots (2)$$

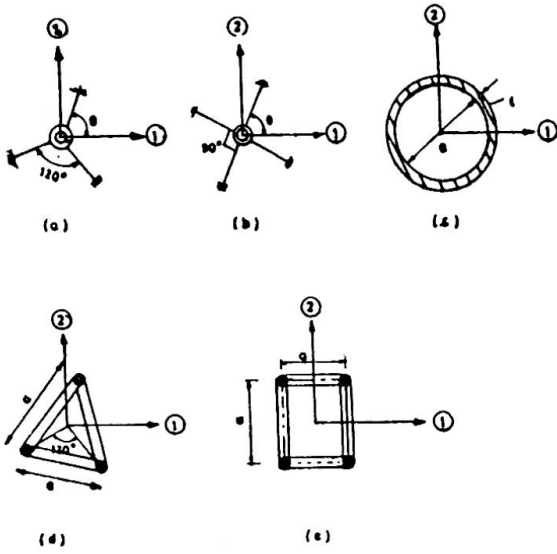

FIG-1 TYPICAL GUY/TOWER CONFIGURATIONS

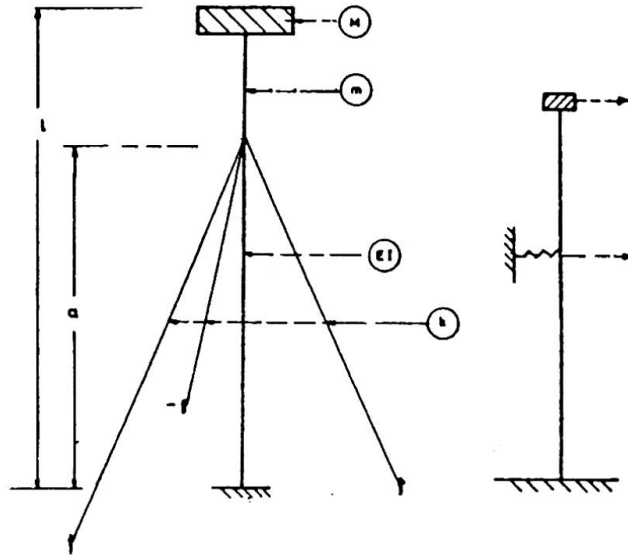

FIG-2 PARAMETERS TAKEN IN THE ANALYSIS

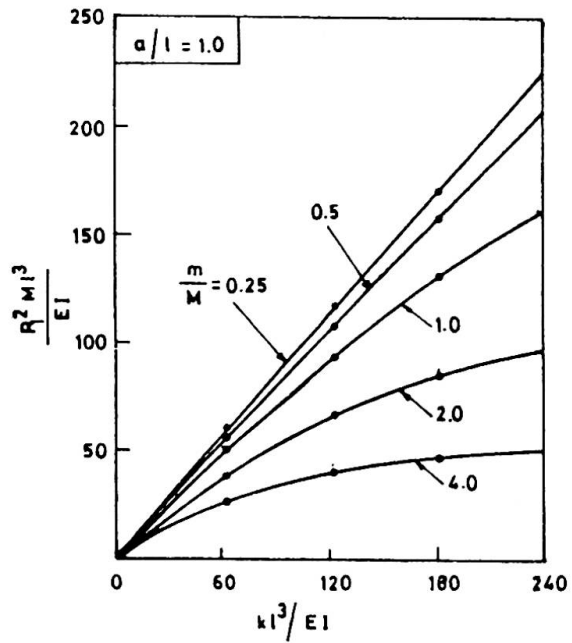
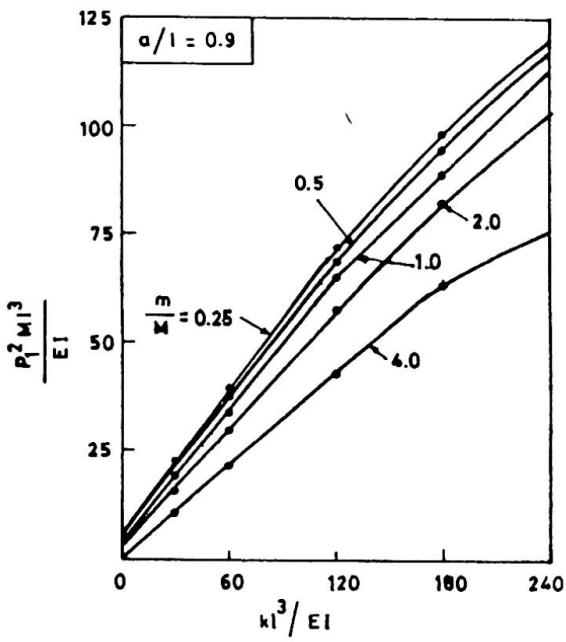

FIG-3 VARIATION OF FIRST BENDING FREQUENCY



where k_s = stiffness of a single guy cable in plan, and
 $k_{12} = 0$

Similarly, it can be shown that for the tower sections shown, the moment of inertia is a constant value in all directions.

3. BENDING FREQUENCIES OF HAWECS TOWERS

The parameters which affect the bending frequency (p) of a guyed tower with top mass can be non-dimensionalised and grouped as follows (Fig.2).

$$p^2 M l^3 / EI = f(a/l, k l^3 / EI, m / M) \quad \dots (3)$$

m = self weight of the prismatic tower, M = top mass of nacelle, EI = Young's modulus x moment of inertia of the tower, k = Stiffness of the guys, a = level of guy attachment point, l = height of the tower, and p = frequency in rad/sec.

A parametric study has been done on Eqn.(3) to find the variation of the frequency parameters $p^2 M l^3 / EI$ against the variation on guy level parameter,

$$a/l = C_1 = 0.5, 0.6, 0.7, 0.8, 0.9 \text{ and } 1.0$$

guy stiffness parameter

$$k l^3 / EI = C_2 = 0, 30, 60, 120 \text{ and } 240 \text{ and mass parameter}$$

$$m / M = C_3 = 4, 2, 1, 0.5 \text{ and } 0.25$$

A linear eigen value solution program has been used for this purpose to generate the frequencies. The value of $p_1^2 M l^3 / EI$ have been plotted for $a/l = 0.9$ and 1.0 (Fig.3) (p_1 = first bending frequency). The second bending frequency parameter taken is $p_2^2 m l^3 / EI$ as there is less variation for this parameter when compared to $p_2^2 M l^3 / EI$. The first mode is a cantilever mode with the mode shape value, largest at the top point. Hence, top mass becomes a sensitive parameter. The second bending mode shape, however, has the largest value near the mid height, thus causing the distributed mass of the tower to be a sensitive parameter. Fig.4 shows the variation in the second bending frequency parameter.

4. RAYLEIGH'S ENERGY FUNCTIONS

There are two Rayleigh's energy functions considered for the evaluation of the first bending frequency of the HAWECS tower [3].

1. The deflection profile of a cantilever with rigidity EI and propped with a spring of stiffness k at the point of guy attachment and having a load at the tip. This worked very effectively for the range of $a/l = 0.5$ to 0.9 . Maximum deviation is found at $a/l = 0.9$, giving an error of 4% in the frequency.

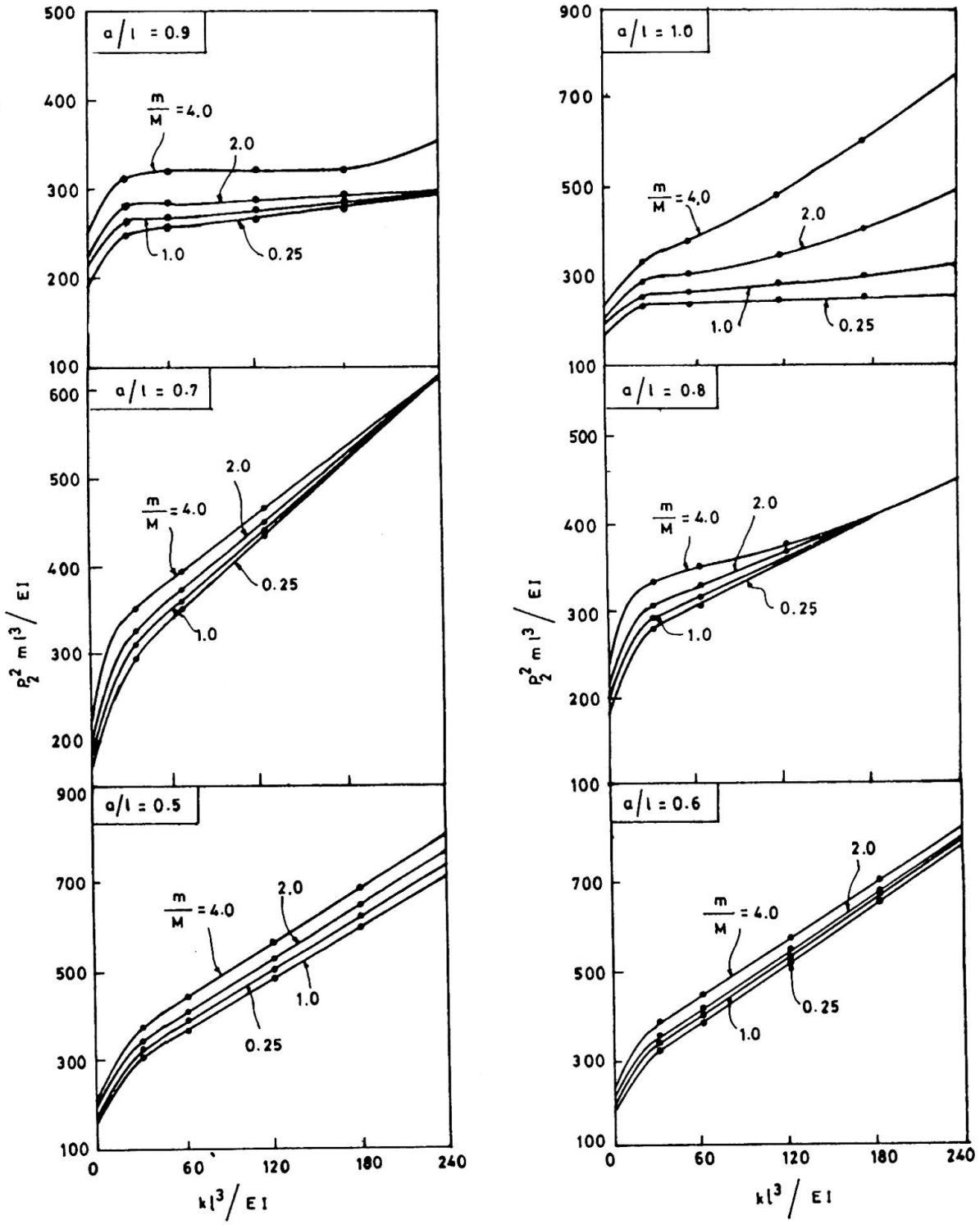

FIG-4 VARIATION OF SECOND BENDING FREQUENCY



Defining $\alpha = x/l$ x AXIS FROM FOUNDATION LEVEL

$$y = \alpha^3 (C_0 - 1) + \alpha^2 (3 - 3C_0 C_1); \quad a > x > 0$$

$$y = -\alpha^3 + 3\alpha^2 - 3C_0 C_1^2 \alpha + C_0 C_1^3; \quad l > x > a \quad \dots (4)$$

$$C_0 = C_2 (3C_1^2 - C_1^3) / (6 + 2C_2 C_1^3)$$

2. For $a/l = 1.0$, the deflection profile considered is for a cantilever of stiffness EI , propped with a spring of stiffness k at the free end and loaded with a mass proportional to M at the free end and m along the length. The resulting deflection is as follows.

$$y = 4\alpha^2 (3 - \alpha) C_0 + C_3 (\alpha^4 - 4\alpha^3 + 6\alpha^2)$$

$$C_0 = -C_2 (3C_3 + 8) / 8(3 + C_2) + 1 \quad \dots (5)$$

The frequency is got by equating the energy terms due to strain energy and kinetic energy.

$$E_1 = \int_0^l \frac{EI}{2} (y''')^2 dx + \frac{k}{2} y^2(a) \quad \dots (6)$$

$$E_2 = p^2/2 \left[\int_0^l \frac{m}{1} y^2 dx + M y(l)^2 \right]$$

$E_1 =$ Strain energy and $E_2 =$ kinetic energy

5. CONCLUSIONS

The three dimensional dynamic modelling can be replaced by a simplified model using the assumptions stated in the paper. By using Fig.3, Fig.4 and the Rayleigh functions given, it is possible to design a HAWECS tower and detune its frequencies away from the forcing frequencies. The effect of rotational inertia of the nacelle on the frequencies can be neglected.

ACKNOWLEDGEMENT

The authors gratefully acknowledge the Director, Structural Engineering Research Centre, Madras, for permitting them to publish this paper.

REFERENCES

1. GOURIERES D.Le., Wind Power Plants, Theory and Design, Pergamon Press, 1982
2. DAVENPORT, A.G., Dynamic Behaviour of Massive Guy Cables, Journal of Structural Engineering Division, ASCE, June 1965
3. GOPALAKRISHNAN, N., Free Vibration Behaviour of Guyed Towers, M.Tech. Thesis, Indian Institute of Technology, Madras, June 1986