

Zeitschrift: IABSE congress report = Rapport du congrès AIPC = IVBH
Kongressbericht

Band: 14 (1992)

Rubrik: Seminar 2: Bridge design and construction

Nutzungsbedingungen

Die ETH-Bibliothek ist die Anbieterin der digitalisierten Zeitschriften. Sie besitzt keine Urheberrechte an den Zeitschriften und ist nicht verantwortlich für deren Inhalte. Die Rechte liegen in der Regel bei den Herausgebern beziehungsweise den externen Rechteinhabern. [Siehe Rechtliche Hinweise.](#)

Conditions d'utilisation

L'ETH Library est le fournisseur des revues numérisées. Elle ne détient aucun droit d'auteur sur les revues et n'est pas responsable de leur contenu. En règle générale, les droits sont détenus par les éditeurs ou les détenteurs de droits externes. [Voir Informations légales.](#)

Terms of use

The ETH Library is the provider of the digitised journals. It does not own any copyrights to the journals and is not responsible for their content. The rights usually lie with the publishers or the external rights holders. [See Legal notice.](#)

Download PDF: 08.02.2025

ETH-Bibliothek Zürich, E-Periodica, <https://www.e-periodica.ch>



Seminar 2

Bridge Design and Construction

Projet et construction de ponts

Brückenentwurf und -konstruktion

Organizer: Y. Fujino,
Japan

Leere Seite
Blank page
Page vide

Fabrication Survey of Steel Components facilitates Quick Bridge Erection

Contrôles de fabrication pour le Pont Hooghly à Calcutta

Werkstattkontrolle der zweiten Hooghly Brücke in Kalkutta

Rudolf BERGERMANN

Consult. Eng.
Schlaich Bergermann und Partner
Stuttgart, Germany



Ulrich DILLMANN

Consult. Eng.
Schlaich Bergermann und Partner
Stuttgart, Germany

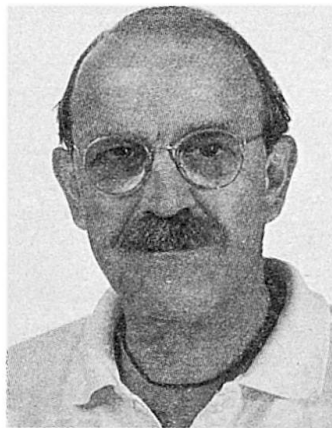

SUMMARY

Details of the fabrication survey, allowable tolerances, measurements, trial assembly and their favourable effect on the speed and accuracy of erection are described for the second Hooghly Bridge in Calcutta.

RÉSUMÉ

Des aspects particuliers du contrôle de la fabrication tels que les tolérances admissibles, l'ampleur des mesures de contrôle, l'assemblage d'essai, ainsi que leurs répercussions favorables sur la vitesse et la précision du montage sont traités dans cet article.

ZUSAMMENFASSUNG

Einzelheiten der Fertigungsüberwachung, wie zulässige Toleranzen, Umfang der Messungen, und Probezusammenbau werden in ihrer günstigen Auswirkung auf die Geschwindigkeit und Genauigkeit der Montage beschrieben.



1. INTRODUCTION

One of the world's largest cable stayed bridges is going to be completed within one year. The main components of superstructure like towers, deck grid and cables are prefabricated steel elements requiring a thorough survey at the fabrication stage

- to control imperfection, a significant load case for slender structures,
- to ensure fast erection progress without adjustment or rectification at site,
- to install cables geometrically controlled instead of using cable tensioning force as the main guidance.

2. GEOMETRY SURVEY DURING FABRICATION

1.1. Pylons

For the box sections of towers a fabrication survey procedure had to be established to control eccentricities of pylon axis either in longitudinal or in transversal direction of the bridge.

Space restrictions and progress of erection did not permit a full shop floor layout for the towers as it had been done for previous bridges. Transport and lifting facilities limited the length of a single box to a maximum of 6 m. Therefore one pylon leg comprises 19 sections up to the level of top portal.

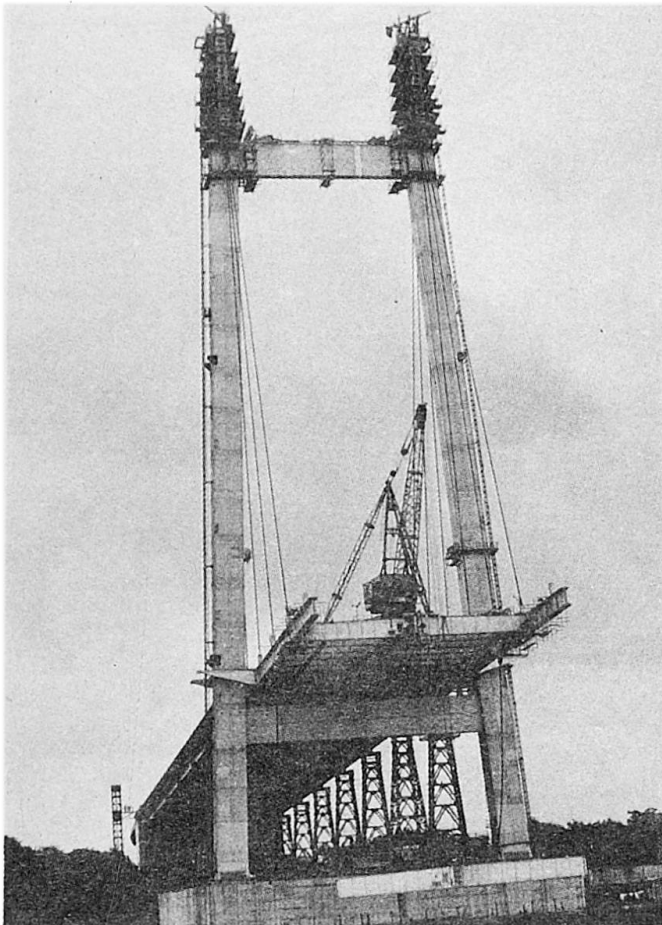

Fig. 1
H-shaped, 122 m high pylon at
Calcutta side

Deviations from nominal pylon leg axis are caused mainly through skewed cutting of box section ends. On this account utmost care was taken during individual box machining. Before cutting of the second face was taken up, the box was aligned in reference to the face which was cut first. For this a dial gauge was mounted on the extended spindle of milling cutter to check perfect setting.

If cuts of an individual box are not perpendicular but planparallel (see A in Fig. 2), the amount of deviation from nominal axis is negligible, whereas non-planparallel cuts may lead to unacceptable eccentricities (see B in Fig. 2).

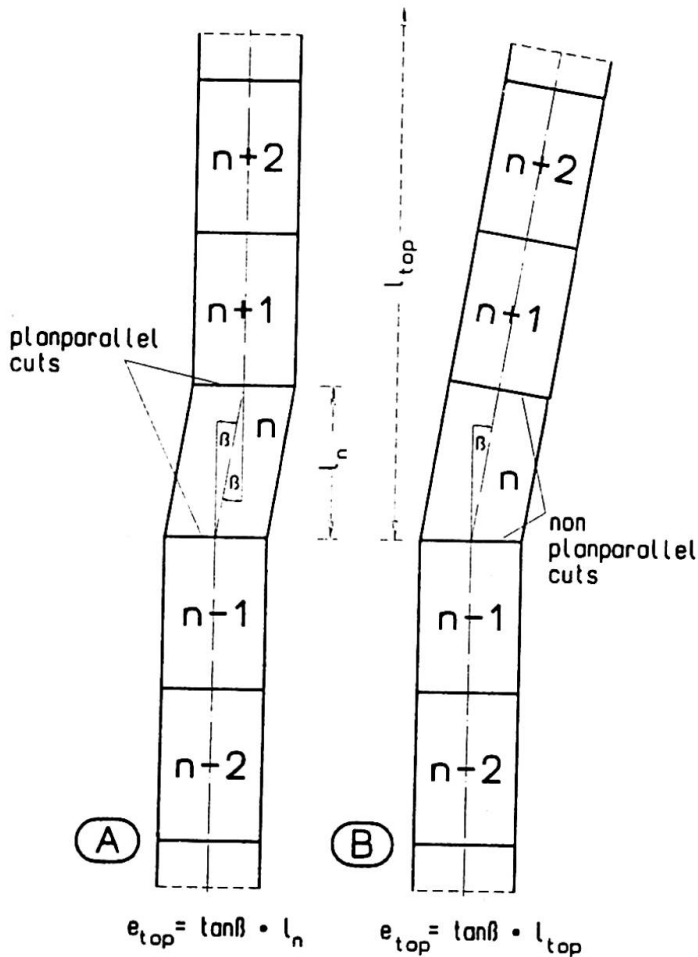

Fig. 2
Axis deviation due to skew cutting of individual section. For illustration (A) the skewed but planparallel cuts cause only a negligible shift of the axis.

An additional, but undetected deviation from the axis occurs due to a built-in error in survey procedure. Considering a 1 mm error per control assembly survey and assuming that the error accumulates in same direction for further assemblies, the deviation from nominal axis at the top amounts to 32.5 mm taking entirely 10 nos. of assemblies and the reference length is 20 m per assembly (see Fig. 3).

The undetected deviation at the tower top will increase with less reference length per assembly and more numbers of surveys. For that reason it could not be agreed to control assemblies with 3 or even 2 sections only.

Shop floor survey for pylon legs has been executed with 4 sections per assembly horizontally laid out starting with base elements. By removing 2 rear sections and adding 2 sections at the front next assembly configuration was found. In Fig. 4 survey procedure for pylon legs is shown in principle for two subsequent assemblies. With a theodolite two perpendicular optical planes have been established. The intersecting line of these two optical planes represents nominal pylon leg axis. The offsets from the optical planes towards the wallplates of box sections were measured by scale in x-and y-direction. As a result, deviations from the axis were recorded.

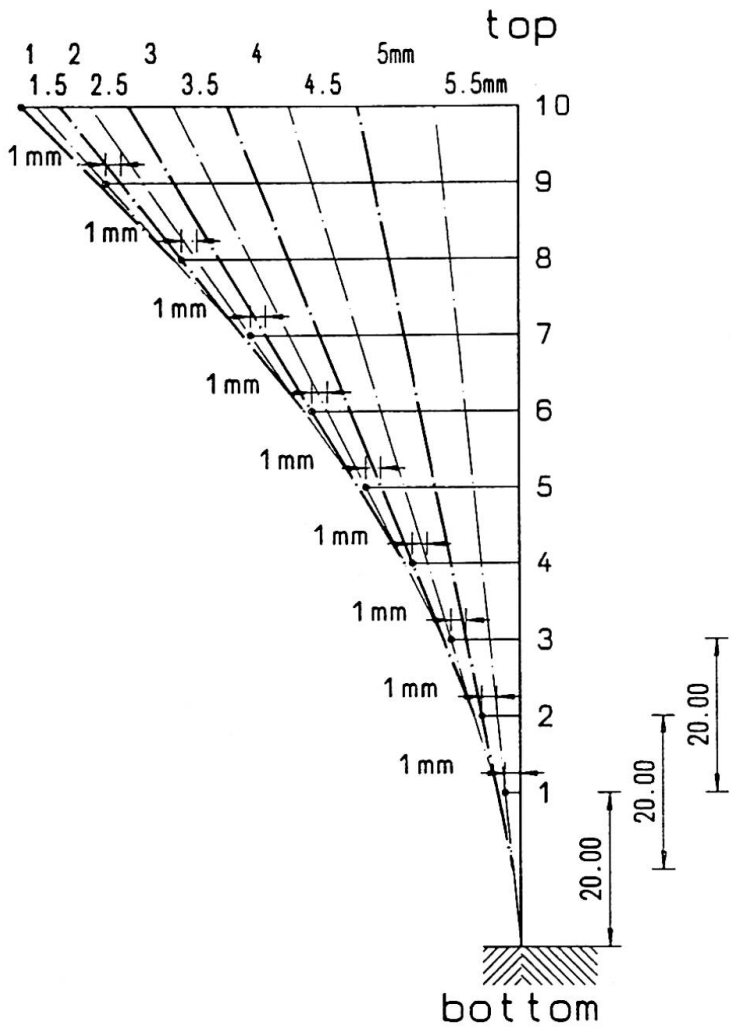

Fig. 3
 Undetected deviation from nominal axis due to accumulative built-in error in control assembly survey, 10 nos. of assemblies with reference length of 20 m for each assembly lead to an eccentricity of 32.5 mm at top if built-in error is 1 mm per assembly.

Only in two cases recutting of box sections was required to keep eccentricities within acceptable limits. For all four pylon legs difference between nominal to actual axis was found to be within 25 mm for longitudinal as well as for transversal direction of the bridge. The actual length of box sections was controlled by tape measurement and differential height of two adjacent tower legs was within a couple of millimetres.

2.2. Deck grid

Since stiffness perpendicular to the web is low for longitudinal girders (I-sections), the alignment in direction of predominant stiffness only was checked at shops. Two girders with 12.3 m length each were assembled and offsets checked taking reference at the top flanges. The range of deviation from nominal to actual axis for individual longitudinal girders was limited to ± 6 mm to keep constraints during erection of cross girders low. In case survey revealed a tendency of violating the deviation criteria subsequent girders were cut in order to reduce misalignment.

2.3. Cables

Actual fabricated length of cables is guided by the cutting length of wires. Each wire is cut on a wire cutting bench controlling major differences in length. After fabricating the cables the actual lengths between the cable sockets are measured under preload by calibrated steel tape.

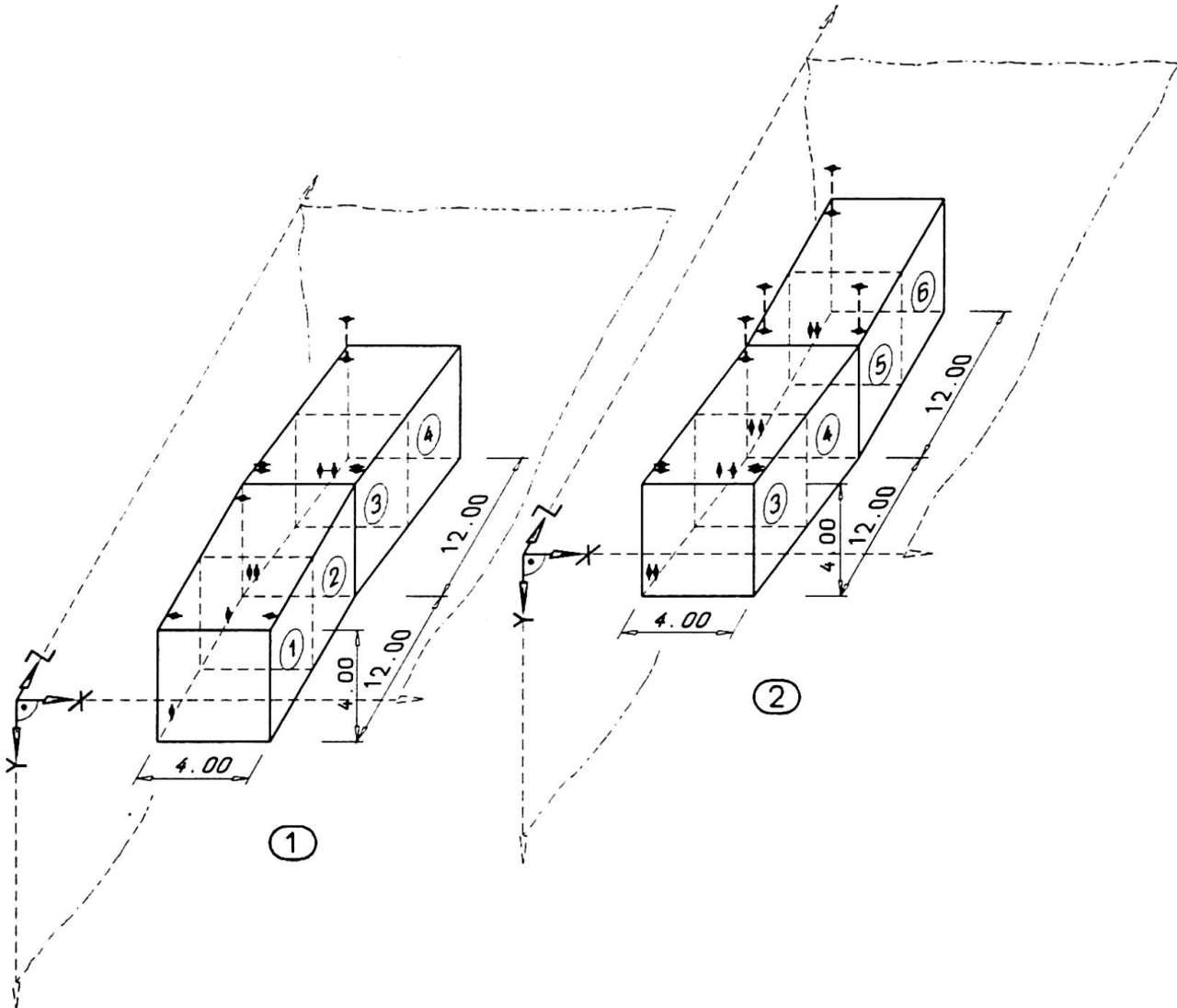

Fig. 4

Sequence of control assembly for pylon leg, offsets at boxes 3 + 4 in assembly (1) are identical to offsets at same boxes in assembly (2) achieved by analytical transformation.

3. EFFECT ON ERECTION

After completion of pylons and advanced deck grid and cable erection, it has been confirmed, that the erection of Second Hooghly Bridge really has been facilitated by the accurate fabrication:

- the geometrical accuracy of the pylons is very satisfactory, eccentricities at top of free standing towers are within 40 mm and thus very much below values taken for design. As per design data criteria for maximum eccentricity due to unstraightness of tower legs is

1/750 of length, i.e. 140 mm in longitudinal direction of bridge at top portal level. It may be mentioned that setting of individual pylon legs at site was done with 4 elements corresponding to first control assembly at shops. By using identical shop survey points at site and relying on sufficient reference length of 4 sections an accurate profile for pylons was achieved.

- no adjustment or rectification at joints was necessary at site leading to fast, uninterrupted erection. Portal girders could be closed without major problems and quality of butt contacts is indicating proper matching of longitudinal girders.
- erection surveys for the deck grid and for the towers are showing conformity with the erection stage analysis.

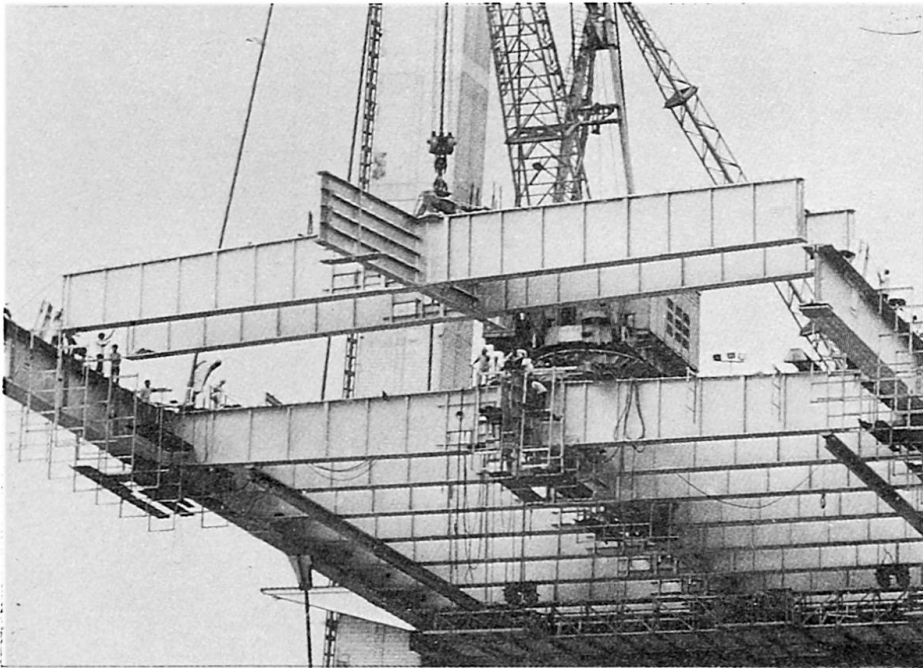

Fig. 5
Preassembly of middle girder and 4 cross girders being lifted. Both main girders are already in final position.

knowing actual fabrication geometry of steel components and actual location of concrete piers the deviations with reference to nominal bridge design geometry were evaluated and adjusted by height of shim packs positioned at pylon head anchors. Hence, erection of the Second Hooghly Bridge is principally guided by geometry meaning more comfort for site. Cable tensioning force is recorded only as a second order check.

REFERENCES

- [1] R. BERGERMANN and P.C. BHASIN:
Design and Construction of Superstructure of Second Hooghly Bridge in Calcutta.
IABSE/IVBH Prereport Seminar Bangalore, 3. - 5. Oct. 1988.

Aesthetic Design of a Cable-Stayed Bridge

Conception esthétique d'un pont à haubans

Ästhetischer Entwurf einer Schrägseilbrücke

Shin'ichi FUJIMORI

Chief
East Japan Railway Co.
Aomori Japan



Takeshi TSUYOSHI

Civil Engineer
East Japan Railway Co.
Aomori, Japan



Toshihiro SAITO

Assist. Chief
East Japan Railway Co.
Sendai, Japan



Noboru SHIMIZU

Civil Engineer,
East Japan Railway Co.
Sendai, Japan

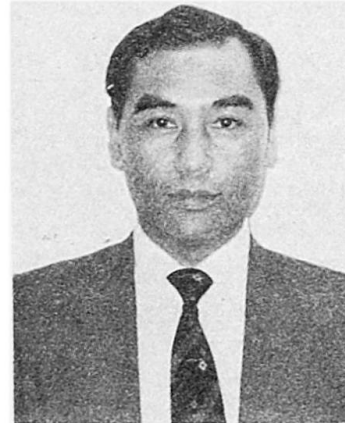

SUMMARY

The Aomori Bay Bridge is a 1.2 km long coastal road bridge. At the portion over the railway station and the bay, a 500 m long three-span continuous prestressed concrete cable-stayed bridge was planned and is now under construction. This paper deals with the aesthetic aspects of the cable-stayed bridge, such as the type of structure, color selection, and designs of parapets and other appurtenances which were considered at the design stage.

RÉSUMÉ

Le pont routier d'Aomori-Bay, qui franchit le port d'Aomori sur le littoral, a une longueur de 1.2 km. Le tronçon actuellement en construction, qui enjambe la gare et la mer, a été projeté comme un pont à haubans à trois travées continues en béton précontraint, d'une longueur totale de 500 m. La présente communication examine les aspects esthétiques dont il a été tenu compte au cours de l'étude de ce pont haubané, entre autres le type de structure, le choix des couleurs et la conception des accessoires comme le garde-corps.

ZUSAMMENFASSUNG

Die Aomori-Bay-Brücke ist eine Hafenstrassenbrücke mit einer Länge von 1,2 km. Für die Strecke über einen Bahnhof und die Bucht ist eine Drei-Feld-Schrägseilbrücke aus Spannbeton mit einer Länge von 500 m vorgesehen, die gerade im Bau ist. Im Text werden die ästhetischen, landschaftsbezogenen Aspekte bei den Überlegungen zum Entwurf der Schrägseilbrücke dargelegt, wobei u.a. Art der Konstruktion, Bestimmung der Farbe sowie Gestaltung des Zubehörs (wie z.B. Geländer) behandelt werden.



1. INTRODUCTION

Since its opening, Aomori Port has continued to expand in the east-west direction, encompassing a railway station. For the purpose of integrating port facilities and streamlining physical distribution, a harbor road spanning the railway station and the bay whose opening is scheduled for the summer of 1992 was planned (Fig. 1). Currently under construction as the main structure of the bridge portion (1,229m) of the harbor road, which has been named "Aomori Bay Bridge," is a 498m long, 25m wide prestressed concrete cable-stayed bridge with a central span of 240m, which is one of the largest bridges of its kind in Japan (Fig. 2).

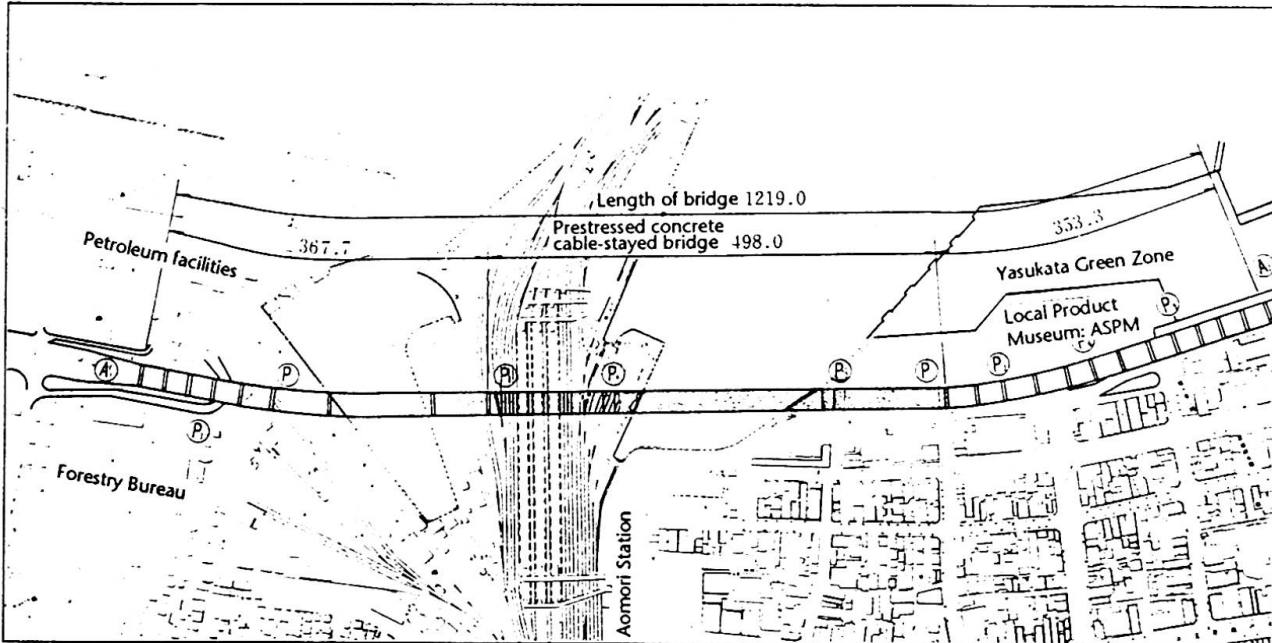

Fig. 1 Plan View of the Bridge Site

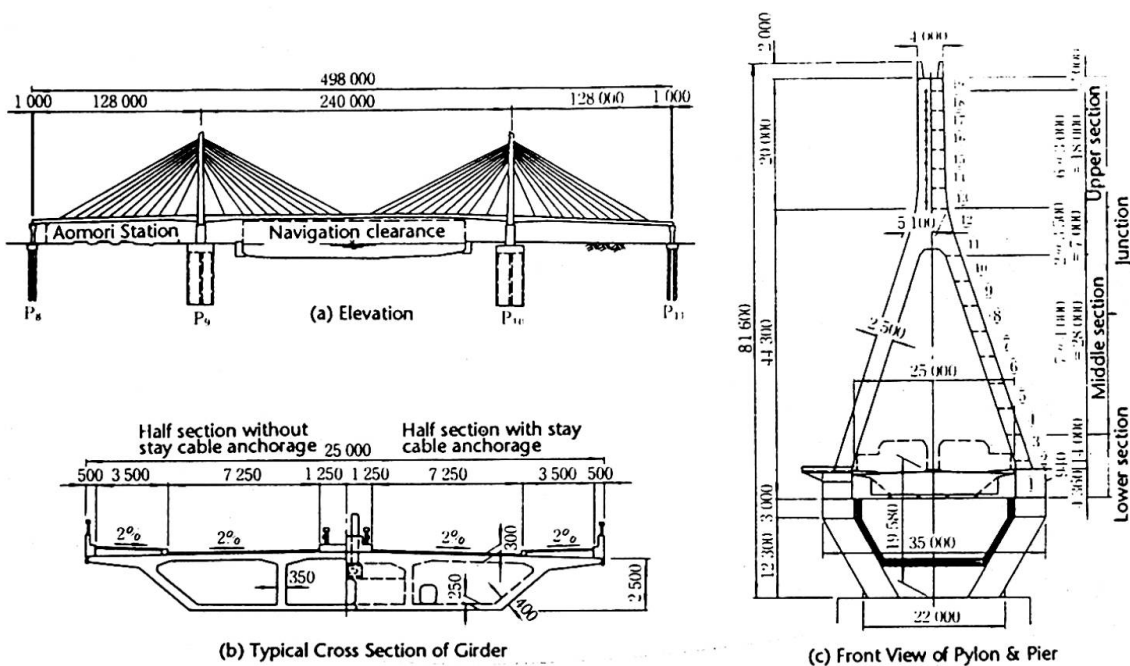

Fig. 2 General View of the Cable-Stayed Bridge



Under "Port Renaissance 21 Project," a port renewal project aimed, looking into the 21st century, at repositioning Aomori Port Area as an area which supports the prefectural capital of Aomori, establishing harmony among the functions of physical distribution, production and life supporting, and creating a richer and more humane harbor space.

In designing the above prestressed concrete cable-stayed bridge, therefore, various aesthetic elements were taken into consideration, positioning it as the monument of this waterfront project, so that the bridge as a structure goes well with and blends into the environment.

This paper outlines the aesthetic design of this cable-stayed bridge.

2. TYPE OF STRUCTURE

Since the bridge was to span the station and the bay, it was understood that the cantilever erection method was possible. With this condition in mind, various types of structures including structural materials were evaluated, and as a result the prestressed concrete cable-stayed bridge was adopted. A prestressed concrete cable-stayed bridge allows a variety of combinations of stay cable arrangement and tower configuration and thus a high degree of structural freedom. For the bridge under this project, a single-plane suspension system where points of suspension are located on the medial strip has been adopted, so that the tensioning of stay cables can be carried out in the box-girders and pedestrians and drivers crossing the bridge can enjoy landscapes. As for the configuration of pylons, inverted Y-shaped pylons which would match "ASPM," a pyramid-shaped local product museum adjacent to this bridge, were adopted, and high-strength concrete with a design strength of 60MPa was employed for a slender structure.

3. STUDY ON COLORING

In order to establish harmony with the environment and make the structure of the bridge as symbolic as possible, coloring for the bridge was studied, too. For this purpose, freely colorable FRP tubes (glass fiber reinforced plastic tubes) were used for cable tubes, and painting materials were selected after their durability was confirmed through a series of tests. After the color selection policy was established, background colors of the environment were investigated, and desirable colors were decided through color simulation.

3.1 Color Selection Policy

In anticipation of future port renewal projects, a lasting color scheme was to be selected. Color selection was made taking account of the following requirements:

- 1) The colors of the bridge should go well with those of the environment.
- 2) The colors of the bridge should be suitable for the structural characteristics of the prestressed concrete cable-stayed bridge.
- 3) Coloring suitable for a monument should be studied.
- 4) In consideration of a night-time lighting up plan, colors should be planned for a better lighting effect.
- 5) Since the huge bridge will cut the skyline substantially, dark colors should be avoided.
- 6) The bridge should be designed based on the understanding that it is a coastal bridge.



3.2 Results of Color Study Using Color Simulation

3.2.1 Stay cables

Stay cables have a characteristic structural beauty of cable-stayed bridges, and their large plane-like spaces have good color effects. Color simulation was performed for four sets of desirable colors, namely, (a) gold, (b) white, (c) gradation of reddish colors, and (d) gradation of blue-greenish colors. As a result, (a) gold, which can express heaviness and richness, is highly symbolic, changes its hues under natural sunlight, and has freshness and uniqueness, was adopted.

3.2.2 Pylons, piers and main girders

In deciding the colors of these elements, the stage effect to make the impressive gold of the stay cables look neat and symbolic was considered. Bright neutral colors were used as base colors, which were to be accented with small areas of the same or similar hues as stay cables or contrasting hues, so that a vivid impression was created.

4. STUDY ON LIGHTING

4.1 Planning Policy

In consideration of the color scheme mentioned above, lighting of the bridge was to be planned so that it harmonized with the lighting around the bridge and of the completed ASPM. The following requirements were considered:

- 1) The night view of the Aomori Bay Bridge should be made attractive by means of an effective lighting scheme.
- 2) Structural characteristics of the cable-stayed bridge should be emphasized, and the stage effects of individual elements of the bridge should be enhanced synergistically.
- 3) A silhouette of the bridge against the sky at night which is different from one under the sunlight should be created.
- 4) The lighting scheme should reflect the characteristics of the seasons.
- 5) An orderly night view of the bridge and ASPM should be created.

4.2 Findings from of the Study

- 1) When viewed at a close range, lighting up of the whole structure awakens a sense of oppression, making us feels as if the structure were going to hang over us.
- 2) Lighting of the overall pylons and stay cables will have an adverse affect on drivers crossing the bridge.
- 3) Lighting of the upper part of the pylons and stay cables will influence the environment only slightly and will be very effective.

From above, it was decided that the upper part of the pylons and the stay cables were to be lit up. In view of the white-green-blue coloring of ASPM, these three colors plus orange, which was to add warmth to the night view in winter, were adopted. Based on the results of a lighting test during construction, it was decided that the stay cables were to be lit up in four colors alternately, and the pylons in white only.

5. CONSIDERATON OF HARMONY WITH ADJACENT STRUCTURES

This cable-stayed bridge, which was to pass in front of ASPM, was expected to obstruct its view. Therefore, it was decided that a gate tower would be built

in front of ASPM and the gate tower would be designed so that harmony among the bridge, ASPM and the gate tower would be established (Fig. 3).

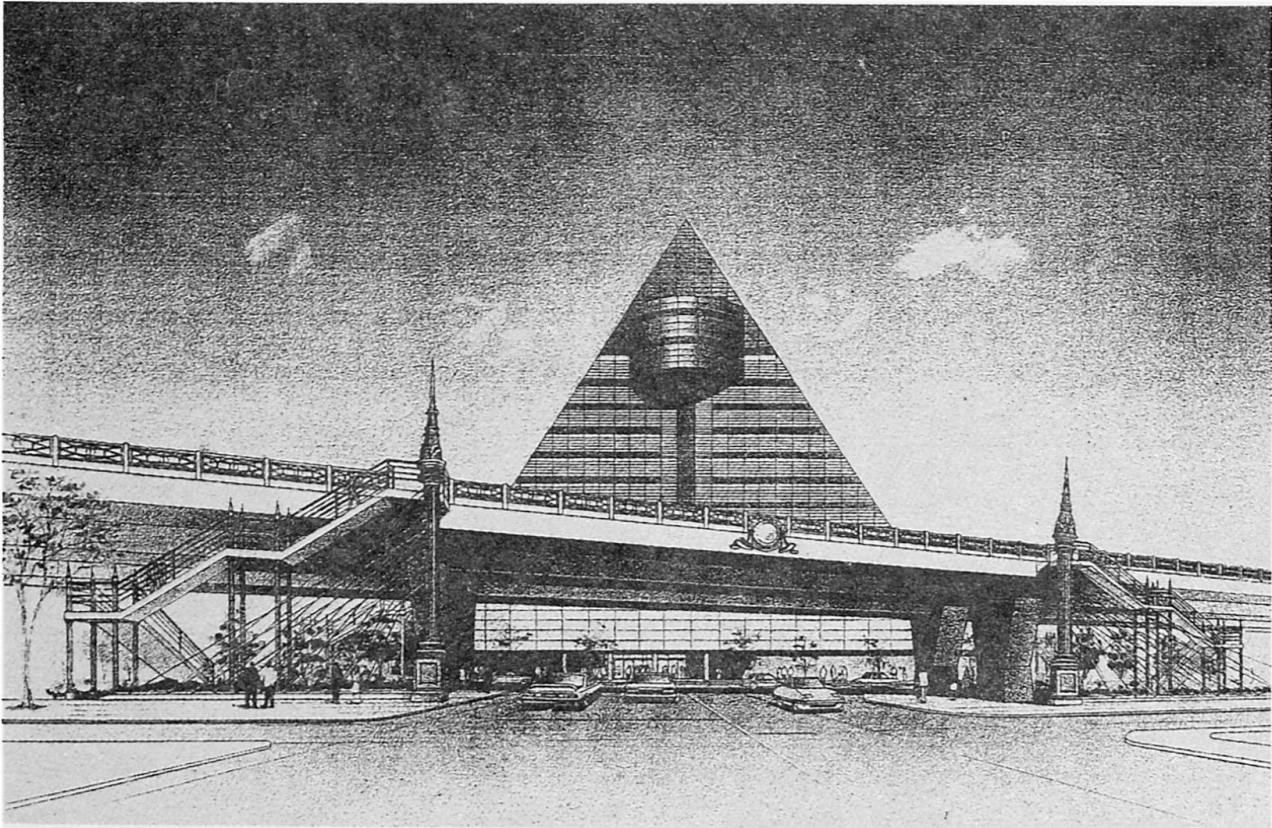

Fig. 3 Architectural View of the Gate Tower in front of ASPM

5.1 Policy of the Study

- 1) To visualize an image of Aomori making progress into the future and of stars which is the motif of the official symbol of the city of Aomori
- 2) To mirror and symbolize the history and tradition of Aomori Port
- 3) To create a design that matches the landscapes of a modern core city in the future, which is the goal of Aomori

5.2 Results of the Study

- 1) The unfavorable image of a bridge passing in front of ASPM was to be improved by creating the atmosphere of a gateway to ASPM and designing a story-telling expression.
- 2) Supports of classical designs in harmony with ASPM and the bridge were to be used so as to conjure up an image of marking the time of visitors to this place and ships entering and leaving Aomori Port like a wall clock marking each day with the light and shadow of the sun.
- 3) Being lit up at night, the gate tower was to be surrounded by a warm light, making us feel as if it were a lighthouse for people walking up and down the streets. In addition, expressions of ASPM were to be decorated colorfully so that ASPM in conjunction with the cable-stayed bridge would attract people's attention.
- 4) The monument at the center of the gate was to symbolize the history, tradition and culture of time.



6. AESTHETIC DESIGN OF PARAPETS AND OTHER BELONGINGS

Belongings, such as parapets, were also designed, taking account of harmony with the environment, so that pedestrians can enjoy peace of mind. Fig. 4 shows the designs thus worked out.

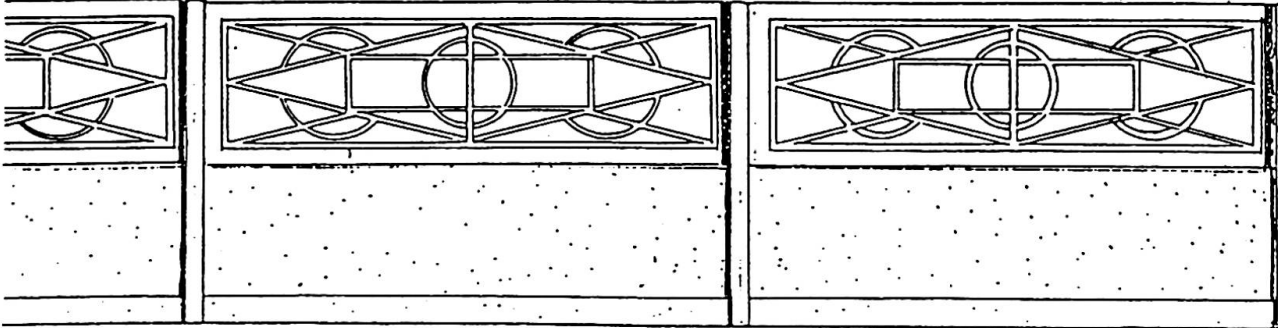

Fig. 4 Design of Parapets

7. CONCLUSION

The Aomori Bay Bridge, whose opening is scheduled for the summer of 1992, is now at the final stage of construction and is beginning to unveil itself. It is believed that various aesthetic considerations, as well as the unique structure of a cable-stayed bridge, will dramatize the existence of the bridge (Fig. 5).



Fig. 5 Photomontage of completed Aomori Bay Bridge

The New Oporto Railway Bridge

Le nouveau pont de chemin de fer à Porto

Die neue Eisenbahnbrücke in Porto

Jorge N. BASTOS
Prof. Aux.
Univ. Técn. de Lisboa
Lisboa, Portugal



Jorge N. Bastos, born 1957, received his civil engineering degree from the Faculdade Engenharia, Universidade do Porto. He attended the University of Texas at Austin where he received his M.Sc. (1983) and Ph.D. (1987) degrees.

SUMMARY

The 114-year old Maria Pia iron bridge designed by Gustave Eiffel became inadequate for meeting increasing railway traffic needs in the Douro river crossing. The 1991 new Oporto double-track structural concrete bridge designed by the Portuguese engineer Prof. Edgar Cardoso meets the most stringent requirements of structural safety, aesthetics and efficiency.

RÉSUMÉ

Par suite de la croissance du trafic ferroviaire sur le fleuve Douro au cours des dernières décennies, le vieux pont de chemin de fer Maria-Pia, projeté par Gustave Eiffel, s'avère insuffisant. Conçu par l'ingénieur portugais Edgar Cardoso, le nouveau pont en béton précontraint à double voie, construit en 1991, répond aux exigences actuelles fort rigoureuses en matière de sécurité, d'esthétique et de capacité.

ZUSAMMENFASSUNG

Die 114-jahre alte, von Gustave Eiffel entworfene Maria-Pia-Eisenbahnbrücke ist durch den wachsenden Eisenbahnverkehr über den Douro unzulänglich geworden. Die 1991 neu erbaute, doppelspurige Spannbetonbrücke, von dem portugiesischen Ingenieur Edgar Cardoso entworfen, vereint die strengsten Anforderungen in bezug auf Sicherheit, Ästhetik und Leistungsfähigkeit.



1. INTRODUCTION

In the North of Portugal, between the cities of Oporto (north bank) and Gaia (south bank), flows the river Douro whose crossing represents a great challenge to structural bridge engineers.

In 1991, with the addition of a fourth railway-type bridge to the already existing railway and highway bridges, a major improvement in the north-south communications network has been reached. This new railway bridge represents one of Prof. Edgar Cardoso finest designs in his 55-year long successful career as a bridge engineer.

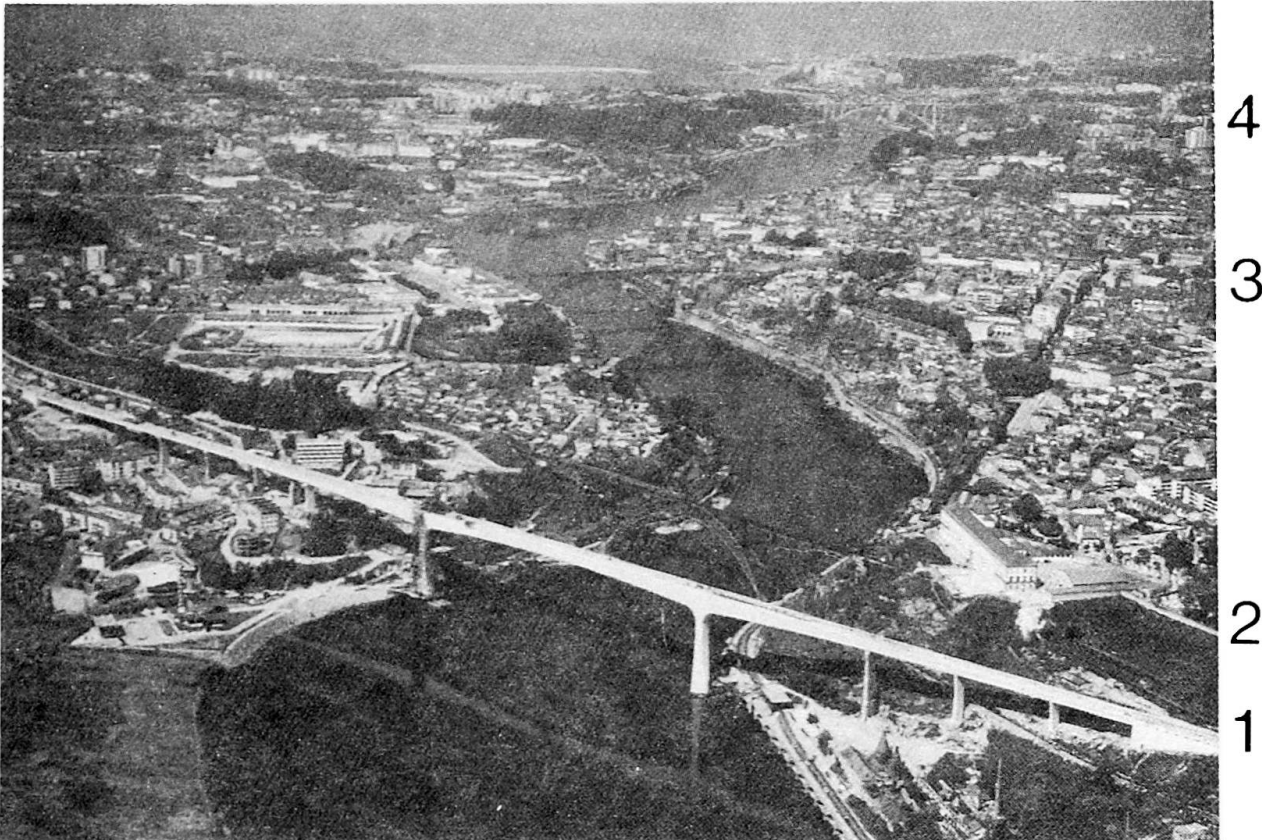

- Legend: 1 - New Oporto Railway Bridge (1991), Prof. E. Cardoso;
 2 - Maria Pia Railway Bridge (1877), Gustave Eiffel;
 3 - Luiz I Roadway Bridge (1886), Theophyle Seyrig;
 4 - Arrábida Highway Bridge (1963), Prof. E. Cardoso.

Fig. 1 - Aerial View of the Oporto-Gaia Bridges.

The other three bridges are: (a) the 1877 railway iron arch bridge designed by Gustave Eiffel; (b) the 1886 roadway twin-deck iron arch bridge conceived by Theophile Seyrig; and, (c) the 1963 reinforced concrete arch highway bridge designed by Prof. Eng. Edgar Cardoso.

Among the four bridges of Fig.1, only the first and the second one which are of the same railway type are studied. The limitations and solutions the two bridge masterbuilders faced more than 100 years apart in the design and construction of these two major civil engineering public works will be shown with particular emphasis on the New Oporto Railway Bridge.

2. THE 1877 GUSTAVE EIFFEL MARIA PIA BRIDGE

In 1875, the Royal Portuguese Railroad Company organized a major European bridge

design competition for the Douro river railway crossing between the cities of Gaia and Oporto. The winner was the 43-year old French engineer Gustave Eiffel. The solution presented to the committee consisted of a single steel arch hinged at the abutments and with the maximum span of 160.00 m and the total height of 62.40 m, Fig. 2, [1, 2].

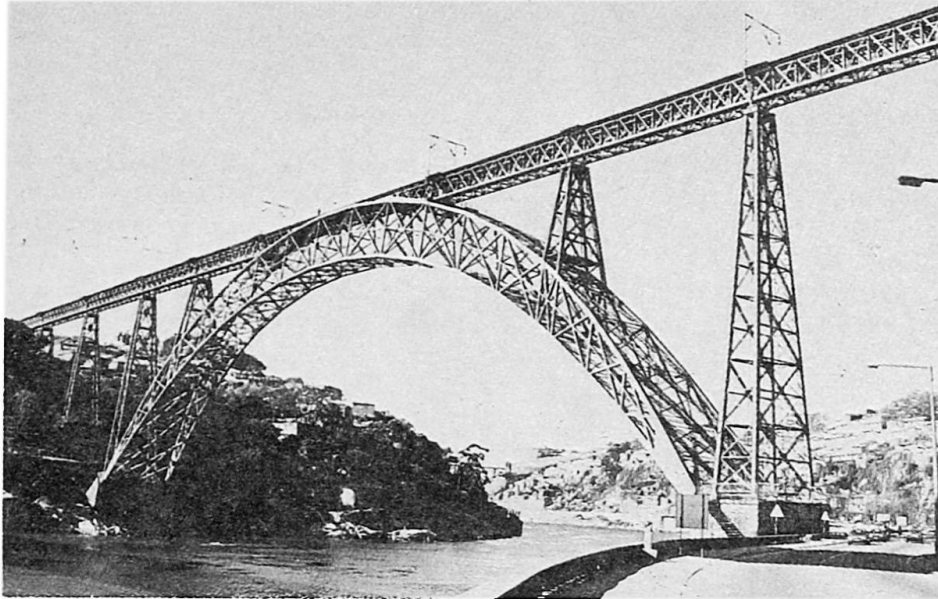

Fig. 2 - Gustave Eiffel 1877 Maria Pia Bridge.

The bridge has a total length of 352.75 m, the straight trellis girder is supported by piers whose height varies according to the ground. The girder deck is divided in three parts : (1) the Gaia flanking deck, 169.87 m long, supported by the masonry abutment, the two ground based iron piers, the two piers fixed to the arch extrados, and the arch; (2) the 51.88 m long central deck integral with the arch; and, (3) the 132.50 m long Oporto flanking deck with support conditions similar to Gaia side.

The estimated 965,000 French francs price was 46% less than that of the second-placed competitor, the well-known Fives-Lille Co. - 1,410,000 francs. The difficulties arising from this construction project were enormous: (1) the water depth in the V-shaped granite valley could reach easily 20.0 m; (2) the frequency and extent of flooding during the winter season; (3) the high gravel soil depth covering the bedrock; and, (4) the very rapid swirling currents. The logical design was a single iron arch, hinged at the masonry abutment supports. During the construction phase, each arch portion rising from the river banks was moored with temporary steel cables until both parts met and the arch was closed.

In this project, G. Eiffel noticed that two major design problems would arise: (1) the trellis girder wasn't continuous along its total length, which made it unsatisfactory for train emergency stops on the bridge; and, (2) there was the danger of train derailment and the bridge had no accident stop barriers. In G. Eiffel improved design of the 1881 Gabarit viaduct, the railway trellis girder was made continuous from one abutment to the other, and the rail track was placed 1.66 m below the upper flange girders plate to encase the train during a major derailment situation.

The Maria Pia bridge project made Gustave Eiffel, at the age of 46, the leading bridge engineer in Europe and gave his relatively young construction company widespread reputation.

The 1902 progressive renovation of the Oporto-Lisbon one-track into a twin-track line created major traffic constraints on the use of the Maria Pia bridge.



The other two major limitations were the maximum speed of 20 km/h and the load, a 160 kN concentrated load per axle and a 38 kN/m uniformly distributed load. Therefore, a new railway bridge became a must in the North-South railway link and, in the early 1980's, the Portuguese Government agreed to a new bridge construction project along with major improvements in the Great Oporto Metropolitan Transit Network.

3. THE NEW OPORTO RAILWAY BRIDGE

3.1 The New Requirements

The 1.03 km long bridge is part of a 4.0 km completely new railway line linking the Gaia-Devesas to Oporto-Campanhã central railway stations. The Douro river crossing is done at a 66.50 m height which is slightly above (4.0 m) the Maria Pia track, Fig. 3.

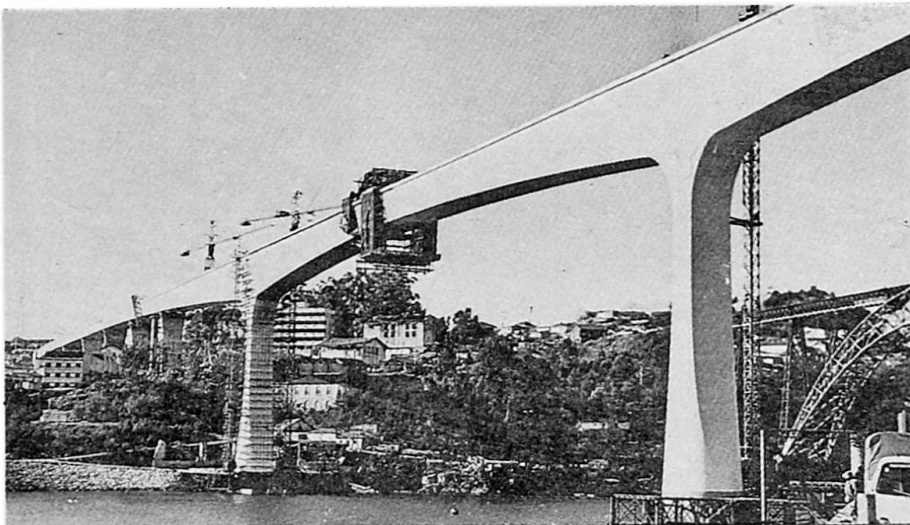

Fig. 3 - The New Bridge near its Completion in 1990.

At a total cost of Esc. 26,000. million (US \$ 175. million), the new 4-km long rail track and the other public works which include the bridge have to meet modern requirements: (1) a high daily traffic volume of 400 trains/day; (2) a high speed twin-lane circulation of 120 km/h; and, (3) the substantially heavier loads of 250 kN concentrated load per axle and 80 kN/m uniformly distributed load. Other important aspects that needed to be considered were: (1) structural safety; (2) aesthetics; (3) economics; and, (4) the scientific knowledge acquisition process during the bridge design and construction phases.

3.2 The Bridge

The bridge's general layout consists of a single structural concrete 1029 m long twin-cell box girder monolithic with the two 50 m tall main piers, Figs. 3 and 4.

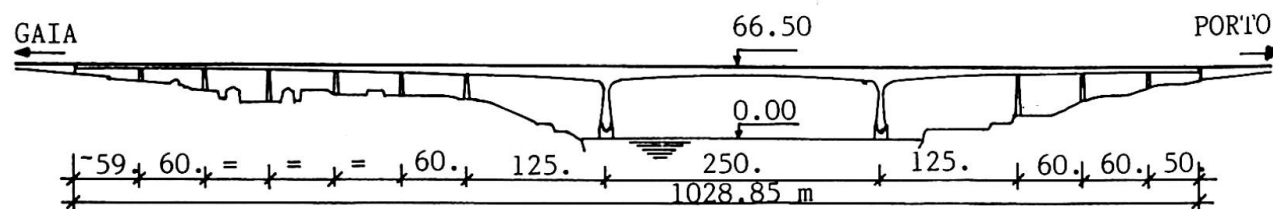

Fig. 4 - Bridge Side Elevation.

The grandiose π - shape portal with a continuous girder over the supporting piers has a 250 m. long main span and 125 m. long side spans. On the left bank (Gaia) approaching side, the girder has one 58.85 m and five 60.00 m long spans

and on the right bank (Oporto) side has only two 60.00 m and one 50.00 m long spans. In plan, the Gaia approach is partly made with a very large radius curve and the remaining portion is made straight until the Oporto bank abutment.

3.2.1 Bridge Foundations

The two main pier foundations were located in the water near the river banks at a variable depth of -10 to -20 m. Difficult ground conditions were similar to those found by G. Eiffel 114-years ago. Prof. Eng. Edgar Cardoso solution required the use of 14. m o.d. steel cofferdams with a contact edge shaped accordingly to the foundation profile. After cleaning the deep (gravel, mud) soil layer, the cracked granite rock mass was pinned with 180 micro-piles made out of five 50-mm diameter high-strength steel rebars ($f_{Sy} = 500$ MPa). These 10 - 20 m long piles served as connectors between the base of the cast in-situ concrete main pier and the sound bedrock. Pozzolanic material was added to the concrete mass for better salt resistance in the submerged main pier section.

3.2.2 Main Piers

The highly aesthetic and functional main piers resulted from the intersection of two families of hyperboloids with the base cylinder, Fig. 3. The 12. m o.d. hollow cylinder has nearly constant 1.0 m thick walls and the cross section smoothly changes into a "strangled" hollow 6.70 * 5.00 m square at 45.0m height. Topping the pier, the initial hollow box girder was cast wide enough (20.0 m) to install two 40 ton. mobile gantries needed to build the main girder.

3.2.3 Main Girder

The twin cell box girder was built by the cantilever construction method which was the best solution for this restraints [3] : (1) a wide span structure in a deep valley (costly centring and falsework); (2) sudden flow rivers; (3) automobile traffic and boat navigation limitations; (4) reduction in formwork costs; and, (5) mechanization of repetitive tasks and improvement in workmanship.

Each one of the 17-pairs of cast in-situ segments, built simultaneously from each side of the main piers, had different geometric dimensions which had to be accommodated by the gantries' suspended formwork. The segment height varied from 12.0 m near the main pier down to 7.0 m at midspan, whereas the length increased from 5.0 to 7.5 m. The first segments weighted 600.0 tons decreasing to approximately 300.0 tons near the midspan. Each newly casted segment was longitudinally prestressed with three pairs of 5,000 kN high-strength prestressing steel cables against the previous built segment. Along the river bank, temporary steel frame shoring was used underneath the girder arm to control exceptional overloads and to perform some deflection adjustments, Fig. 5 - a, b.

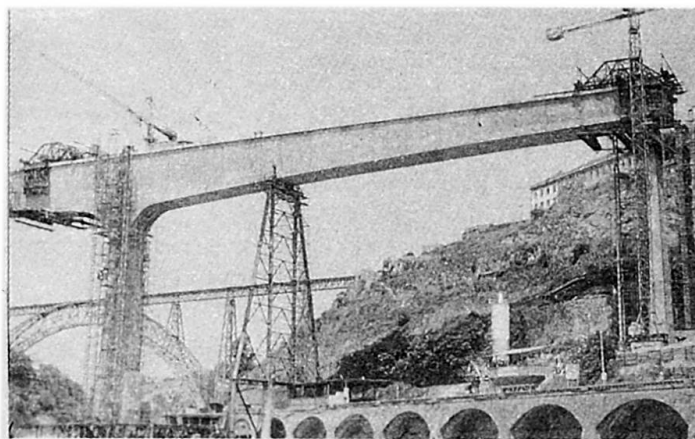
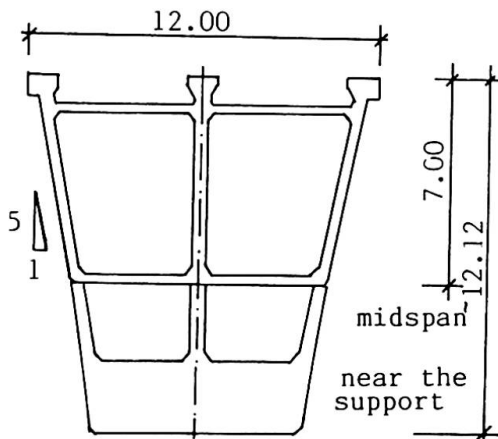

a. Girder Cross Section.

b. Temporary Steel Frame Shoring.

Fig. 5 - Main Girder Characteristics and Shoring Details.



The central span closing segment was 6.0 m long and before the final cast was done the two end sections were pushed apart with hydraulic jacks with a 4,000 kN autocontrainte (prestress) force.

The girder 12.0 m wide cross section has the deck slab 1.25 m below the flanges top fiber, Fig. 5 - a, to: (a) protect on a derailment; and, (b) increase cross section moment of inertia. The rail balastless tracks are continuously attached along the 1029 m girder length.

3.3 Other Improved Technical Solutions

A full-scale model test including three pairs of 5,000 kN longitudinal prestress cables per web, showed that box girder web cracking would arise if special construction measures weren't adopted, such as: (1) vertical web prestressing with unbonded tendons; and, (2) longitudinal structural steel tubing as prestress ducts. These tubes were considered as passive reinforcement in the strength calculations. For deflection control, Prof. Edgar Cardoso used external cables prestressed inside the 500. m main box girder hollow section so that the train live load could be compensated.

4. CONCLUSION

Spanning in time more than 110 years, the construction of the two Oporto railway bridges represent first achievements in the art of bridge engineering. The Maria Pia (1877) iron arch bridge built by the French engineer Gustave Eiffel was one of the greatest contributions to the people's welfare by the Industrial Revolution iron masterbuilders. Excluding the suspension bridges, the Maria Pia bridge 160.0 m span made it one of the largest by that time, along with the Britannia bridge (140.0 m), the Kuilenbourg bridge (150.0 m), and the Saint Louis bridge over the Mississippi (158.5 m), [2].

The 1991 New Oporto Railway Bridge with the gracious π - shape multi-span portal frame designed by the foremost Portuguese bridge engineer, Prof. Edgar Cardoso, represents his culminating effort and knowledge in the field of structural concrete. For a box girder railway bridge, the 250.0 m central span, makes it one the largest spans existent in the world. The difficult site conditions, space limitations required technical solutions that were not common in current bridge design and construction.

Both bridges - one in iron and the other in structural concrete - are excellent civil engineering contributions to human progress as they bring together people separated by a tempestuous river.

REFERENCES

1. BILLINGTON D., The Tower and the Bridge, Basic Books, New York, 1983.
2. LOYRETTE H., - Gustave Eiffel, Rizzoli Intern. Publications, New York, 1985.
3. MATHIVAT J. - The Cantilever Construction of Prestressed Concrete Bridges, John Wiley and Sons, New York, 1983.

ACKNOWLEDGEMENTS

The author would like to express his sincere thanks to Prof. Eng. Edgar Cardoso for his most important comments made during the inumerous construction site visits. The assistance of the Technical University of Lisbon is also gratefully acknowledged.

Innovative Construction and Design of Three Marine Bridges

Conception et construction innovatrices de trois ponts maritimes

Innovative Errichtung dreier Seebrücken

N. RAGHAVAN

Princ. Consult.
STUP Ltd.,
Bombay, India

V.K. KANITKAR

Princ. Consult.
STUP Ltd.,
Bombay, India

P.V. TANTRY

Princ. Consult.
STUP Ltd.,
Bombay, India

N. Raghavan, born 1949, obtained his Masters degree in Technology from the Indian Institute of Technology, Bombay. With STUP Consultants Ltd., he has participated in the design of Nuclear Containments, Bridges, Cooling Towers and Industrial Structures.

V.K. Kanitkar, born 1935, graduated in Civil Engineering from Poona University. At STUP Consultants Ltd., he has participated in the design and execution of water supply and drainage schemes, reservoirs and treatment plants.

P.V. Tantry, born 1932, graduated in Civil Engineering from Poona University. With STUP Consultants Ltd., involved in the design of Naval Jetties, Docks, Pile Foundations, Airline Hangars, Silos, Bridges and Multiflue Chimneys.

SUMMARY

This paper describes the innovative techniques developed for three marine bridge projects to suit the site constraints and infrastructure available. Launching of superstructure girders using tidal variations, use of concrete-steel cofferdam assembly in marine conditions and use of precast segmental construction with centralised casting yard are covered.

RÉSUMÉ

L'article décrit les techniques innovatrices mises au point pour trois projets de pont maritime, devant satisfaire aux exigences de la situation des lieux et de l'infrastructure existante. Il s'agit du lancement des poutres de tablier par utilisation de la variation d'amplitude des marées, l'exécution de batardeau en béton armé en milieu marin et, enfin, la préfabrication de voussoirs centralisée sur un unique chantier de bétonnage.

ZUSAMMENFASSUNG

Der Aufsatz beschreibt die Bauverfahren, die für drei Seebrücken entsprechend der Lage der Baustelle und der verfügbaren Infrastruktur entwickelt wurden. Sie umfassen das Einschwimmen des Brückenüberbaus unter Ausnutzung des Tidenhubs, den Bau eines Kofferdamms aus Beton und Stahl unter maritimen Bedingungen und die Verwendung der Segmentbauweise von einem zentral gelegenen Fertigteilwerk aus.



1. INTRODUCTION

Bridges form a very interesting class of structures and often involve difficult working conditions. For large bridge projects, the choice of the right type of construction technique is very important. Construction techniques have to be evolved suitably fully keeping in mind the site constraints, the infrastructure facilities available and the design requirements. For major bridges an integrated approach coupling design and construction schemes is vital. Again, marine crossings pose more severe challenges and require greater construction skills. Under Indian conditions where sophisticated construction machinery are not generally available and labour is inexpensive and relatively less trained in mechanised construction, innovative approaches have to be evolved to formulate simple and foolproof solutions which also have to be cost efficient in view of the competitive 'Design & Construct' tendering process of awarding bridge projects. In this paper Appropriate Technology in construction and design techniques adopted for three marine bridges is presented.

2. SUPERSTRUCTURE FOR VASAI CREEK RAILWAY BRIDGES

2.1 Description

The two railway bridges across Vasai Creek having 39 and 11 spans respectively are spread over 3 km length, separated by an island. The bridges have two independent decks, each carrying one broad gauge track. Each 48.5 m simply-supported span deck has a single-cell prestressed concrete box girder of 3.3 m uniform depth. Each girder weighed 500 t as cast and 750 t during launching including kerbs and ballast loading. To achieve good quality control all the 78 girders were precast on the shore and launched into position.

2.2 Launching Technique

The creek has a tidal variation of 4.5 m range and this was taken advantage of to evolve an inexpensive and innovative scheme of launching the heavy girders using tidal variations, probably for the first time in India. After precasting, prestressing, grouting and carrying out various finishing activities such as kerbs, waterproofing, wearing coat and partial ballast in the casting yard itself the girder is moved on to a launching jetty. A launching pontoon with a spreader truss on top is brought below the girder at low tide. With rising tide the pontoon rises up and lifts the girder off the jetty. It is then towed to the bridge site using tugs and positioned in location at high tide. As the tide goes down the girder is progressively

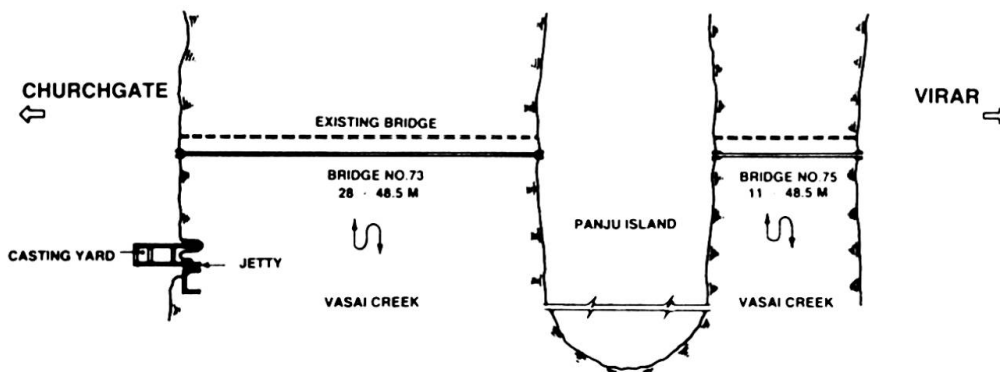

Fig.1 Layout of Bridges and Casting yard

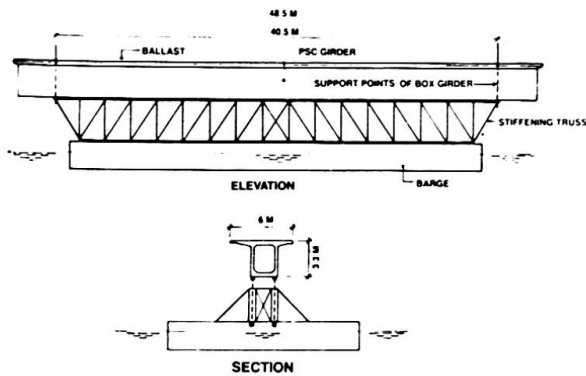

Fig.2 Detail of Launching Pontoon

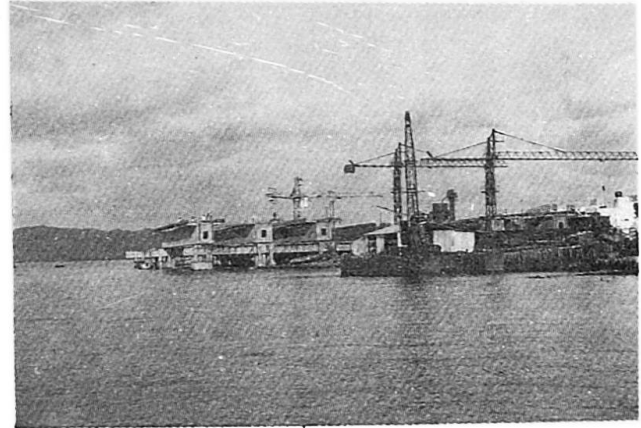

Fig.3 Casting yard with girders

lowered on to its final position. By the judicious use of a number of anchors and winches mounted on the pontoon pulling against the anchors, the positional accuracy could be controlled to within two centimeters. The height of the spreader truss on the launching pontoon was designed to correlate to the relative levels of tides and the final placed elevation of the girders, The level of the launching jetty was also designed accordingly. The longitudinal gradients in one of the bridges was also taken into account. Dredging was carried out at a few locations near shore to ensure sufficient draught for the pontoon. By proper management of the casting and launching cycles a peak speed of seven girders per month was achieved.

2.3 Casting Yard

For the casting yard free land was not available and land had to be reclaimed from the creek. The casting and stacking beds had to be located on piles and considering the limited availability of land and the high costs of reclamation and piling, an optimal layout of casting and stacking beds was evolved and the sequence of casting, finishing and launching accordingly planned. In view of the time constraints two launching jetties were used with a total of four casting beds and seven stacking beds where finishing operations were carried out.

2.4 Design Optimisation

In order to minimise the cost and to reduce the weight of the girder the concrete thicknesses were optimised all along the length of the girder with

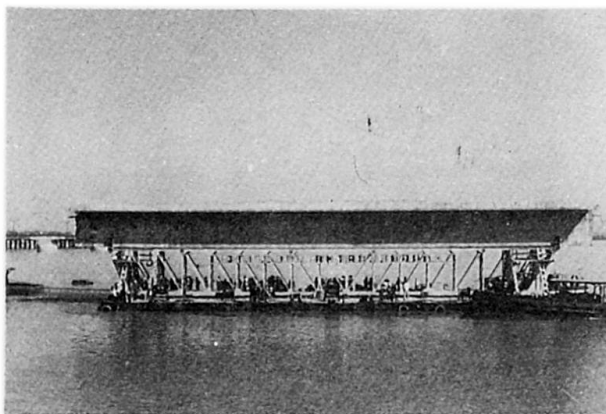

Fig.4 Girder being towed to location

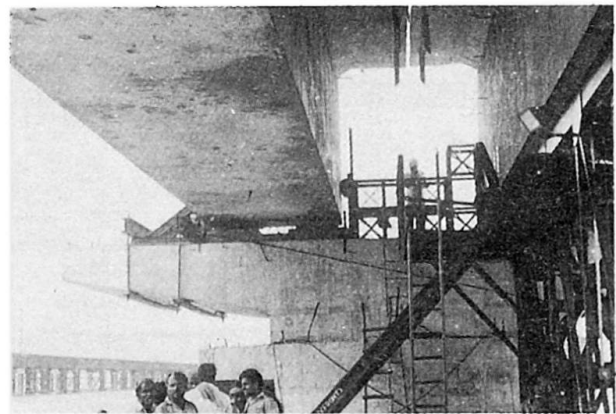

Fig.5 Girder about to be placed



thicknesses of deck and soffit slabs and webs varying along the length. This variation did not pose much problem for construction since precasting was done at one location using a properly designed shuttering scheme. At locations of minimum thicknesses of webs all the prestressing cables were located in the soffit slab, thus eliminating obstructions to concreting.

2.5 Conclusion

A high level of quality was achieved with the adoption of precasting to complete all the operations at shore itself under close supervision and a good speed of construction was achieved with the method of launching adopted.

3. SECOND THANE CREEK ROAD BRIDGE

3.1 Description

When completed this 1.835 km long bridge will form an important link between Bombay and New Bombay. The bridge comprises two independent decks with independent foundations each carrying three lanes of traffic and a footpath. The length of the bridge is made up of six continuous units of typical length of 321 m, with the typical span being 107 m. Each deck has a single cell prestressed concrete box girder of depth varying from 3.5 m to 7 m. Two foundations are with wells/caissons and the others are open foundations, all being socketed into rock.

3.2 Cofferdam Scheme

For the construction of the open foundations in the Creek in order to facilitate working and to cast all RCC under dry conditions, cofferdams were provided. Depending on the depth of water and the depth of bed material above rock, two schemes were evolved. The scheme adopted in the central reaches of the Creek involved an assembly of a lower precast concrete cofferdam and an upper cellular segmental steel shell, with the assembly being handled by a floating gantry. The circular thin-shell concrete cofferdam is precast near shore on a pontoon and brought below the floating gantry. The gantry picks up the cofferdam and the pontoon is withdrawn. While the gantry is holding the concrete shell, the steel shell is added in rings with four segments in a ring, to the required height. Then the assembly is lowered down, the inside bed

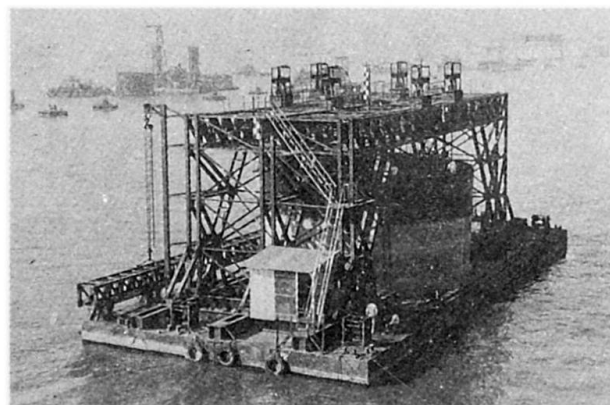
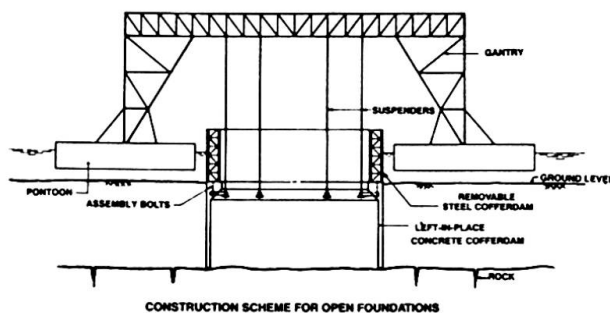

Fig.6 Detail of floating gantry with cofferdam assembly

Fig.7 Cofferdam being lowered

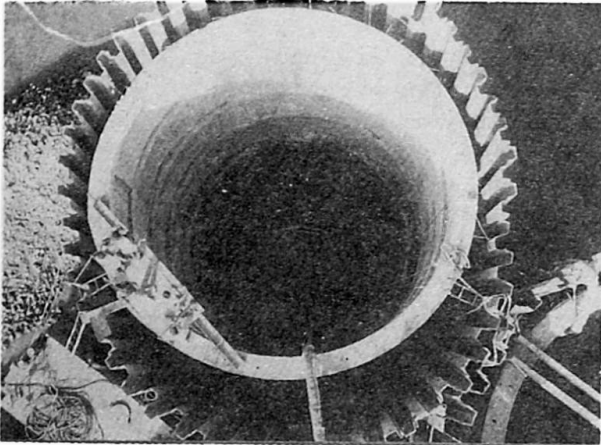

Fig.8 Cofferdam inside sheetpile

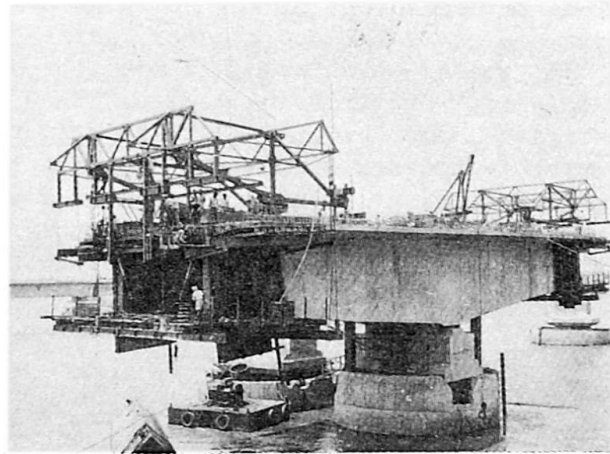

Fig.9 Superstructure cross section

material excavated and the concrete cofferdam seated in rock. The gap between the cofferdam and rock is sealed with an in-situ concrete ring to enable dewatering of the enclosure. After rock cutting the foundation is inspected in dry and the concrete elements of the foundation are built up. Once the foundation comes up above water level, the upper steel shell is dismantled and taken away for reuse and the concrete shell left in place. In the reaches near the shore a sacrificial thin shell concrete cofferdam is cast on sand filling formed inside a steel sheet-pile enclosure and sunk like a conventional well/caisson upto rock. Thereafter the balance operations are as for the other method.

3.3 Design features

The design was evolved to suit this method of construction. The foundation consisted of a PCC plug at the bottom inside a cavity in rock, topped by an RCC pedestal and then a tapered RCC pier.

3.4 Superstructure

The superstructure construction is with cast in-situ balanced cantilever method of construction. To achieve continuity, the key segment between two cantilever tips is cast in-situ. To facilitate the casting of the deep webs prestressing cables were completely eliminated from the webs and located fully in either deck slab or soffit slab.

4. SUPERSTRUCTURES FOR THREE RAILWAY BRIDGES NEAR AROOR-KUMBALAM

As part of the new broad gauge railway network near Cochin three bridges spread over 3 km length had to be built over marine backwaters. The superstructure consisted of 30.5 m long simply-supported spans. The three bridges had 29, 5 and 4 spans respectively. Lack of space at the construction site for storing materials or for a precasting yard posed a problem for the adoption of any conventional method of construction. It was then decided to adopt precast segmental construction. The span was precast in seven segments by the long-line match-casting method in a casting yard located seven km from the site. The segments were brought to site on a pontoon pulled by a tug. For assembling the segments two independent rectangular assembly trusses moved over the pier caps. Underslung cross trusses located between the two main trusses supported the segments.



The segments were picked up by an overhead crab moving over the main trusses, placed on the cross trusses, painted with an epoxy formulation on the match cast faces which also had a number of shear keys and pressed together using temporary prestressing cables. Then permanent cables were threaded through, stressed and grouted. Thereafter the cross trusses were removed and the assembly trusses were moved forward to the next span with the forward end resting on a trestle located on a pontoon and the rear end supported by a trolley moving over the previously erected span. The maximum weight of a segment was 35 t and a span could be completed in one week's time.

5. CONCLUSION

The foregoing examples demonstrate that Indian technology can tackle major bridge projects by evolving simple but effective construction solutions to suit the site constraints and infrastructure available.

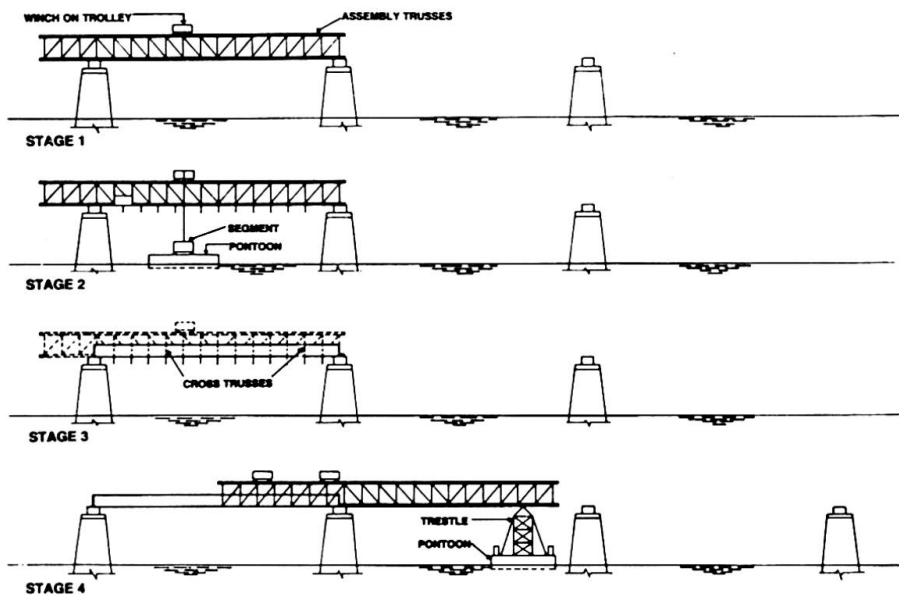

Fig.10 Sequence of assembly of superstructure

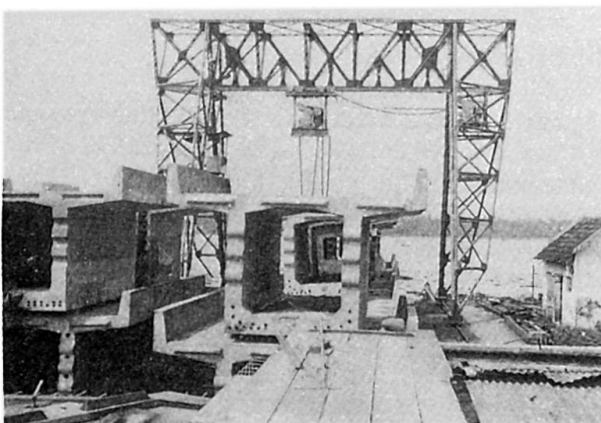

Fig.11 Casting Yard



Fig.12 Assembly Truss

Prestressed Concrete Slab Deck of the Fadalto Bridge

Tablier à dalle précontrainte du viaduc de Fadalto

Die vorgespannte Plattenbrücke des Fadalto-Viadukts

Guido FURLANETTO

Civil Engineer
Italstrade
Milan, Italy

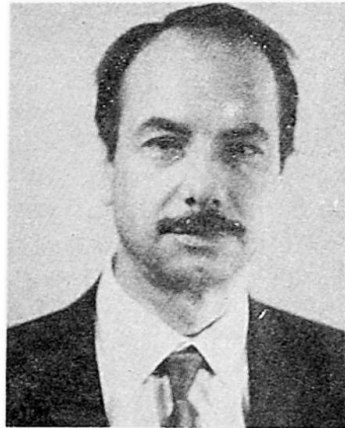

Guido Furlanetto, born 1942, graduated in civil engineering at the University of Padua. He is general manager of Italstrade design office.

Mario BRUNI

Civil Engineer
Italstrade
Milan, Italy

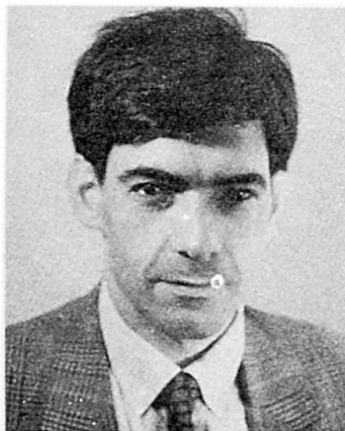

Mario Bruni, born 1958, graduated in civil engineering at the University of Rome. He is structural engineer of Italstrade design office.

SUMMARY

The Fadalto Viaduct superstructure consists of a series of thin slabs, 55 m long, in prestressed concrete. The thickness, at centre line of span, is reduced to 1.10 m. The project work is mainly concerned with the reduction of environmental impact. Its main structural and technical features are highlighted.

RÉSUMÉ

Le tablier du viaduc de Fadalto est constitué par une série de dalles minces en béton précontraint, d'une portée de 55 m. Leur épaisseur est limitée à 1,10 m au milieu de la travée du pont. L'article fournit les raisons du choix de ce projet et notamment de son intégration dans l'environnement. Il met aussi en évidence les caractéristiques principales de l'ouvrage, du point de vue structural et technique.

ZUSAMMENFASSUNG

Der Überbau der Talbrücke Fadalto besteht aus einer Reihe dünner Spannbetonplatten von 55 m Spannweite. Die Bauhöhe ist nur 1,10 m in der Mitte des Brückenfelds. Man beschreibt die Auswahl des Entwurfs und besonders die Einpassung des Bauwerks, in die Umgebung. Die wichtigsten konstruktiven und technologischen Besonderheiten des Bauwerks werden hervorgehoben.



1. GENERAL FEATURES

The viaduct is 3,550 m long and runs half-way up the hill. This presentation is concerned with the structural solution adopted for 6/7 of the whole length (the remaining part was carried out by means of a cantilever structure with spans of 115 m).

From the point of view of the construction technologies adopted, the greatest interest is given by the basic solution of the deck made of 55 m long continuous spans. The choice of this structure was the result of considerations both technical-economical and environmental. In fact the surrounding area is highly attractive. First of all foundation work had to be reduced as much as possible in order to avoid serious damages to the landscape. This is the reason for the choice of a single foundation for the couple of adjoining piers corresponding to the two carriageways. The result is a rectangular foundation having a reduced longitudinal size, which stands, crosswise, at two different ground levels (following the natural slope). Excavation is held up by a cap of jet grouting.

The choice of span was also the result of a series of factors: the height of piers between 15 and 65 m, the necessity to reduce the number of foundations whose heavy costs due to the morphology of ground were a burden to the whole work, the difficulty of entrance to work site with heavy machines and finally the speed of construction.

Nevertheless, technical solutions had to respect criteria of resistance and easy maintenance of the work. The Client (AUTOSTRADE S.p.A.), on a proposal of ITALSTRADE Design office, chose the type of superstructure made in pre-stressed concrete slabs, cast on site, continuous on four spans and connected with the piers, built by means of a mobile truss system running beneath the beams.

The interesting feature of the structure is provided by its architectural slenderness and transparency as well as by the spans of the bridge (55 m). Actually the working out of such an agile and light structure was essential for a correct environmental fitting.

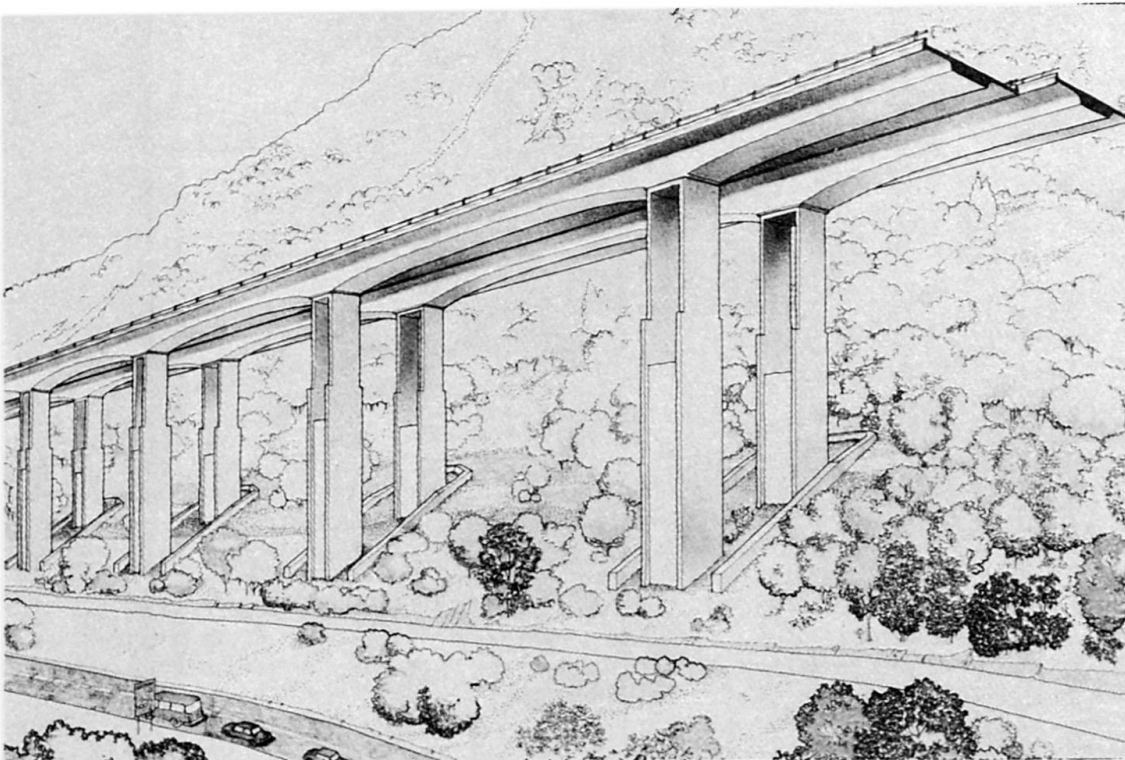

Fig. 1 Perspective view

Studies had to be carried out in order to find out the principal conditions the project had to meet according to the above mentioned factors.

The construction system was meant to be completely free from the ground level in order to proceed easily in the slope section where in fact the ground is very rough.

In such environment, difficulties and cost of excavations drove to the decision to reduce them, as much as possible, bringing structural spans to maximum expectation with the adopted construction system.

The nature of foundation ground made of miscellaneous materials from the "Fadalto ancient landslide", whose chaotic texture confirms a discontinuous geomechanical setting and consequent problems of anisotropy for bearing capacity and differential settlements between piers. Such risk expanded more and more with the horizontal thrust due to the topographic acclivity of the area with a peak of 40° in the slope angle. The deck structure had, therefore, to be flexible enough to absorb any possible subsiding with no consequences.

The construction system adopted had to guarantee an adequate speed in order to complete the 6 km viaduct (slab deck only) as provided for by the contract.

The number of expansion joints and bearing devices of the structure had to be considerably reduced in order to contain inspection and replacement costs and any inconvenience for users. At the same time the structure had to guarantee high duration .

These considerations contributed to the definition of the construction system and structure typology as described in the following paragraphs.

2. SLAB DECK

2.1 General Considerations and Design

The deck structure is made up of a reinforced concrete slab of variable section, longitudinally pre-stressed (Fig. 2). Piers are formed by two reinforced concrete baffles, right angled with the viaduct direction; they run free up to a height of 15.5 m from the bottom deck and downwards are connected by two walls so as to form a box-shaped section. The deck is fixed to the baffles: neither relative displacements nor relative rotations are allowed. The longitudinal movements due to the thermal variations, creep and shrinkage of concrete, are absorbed by expansion joints located every 4 spans in a section 16 m from pier centre line where the structural continuity is interrupted. In such a way, the structural configuration is given by several frames formed by four decks and their piers which are completely integrated between them. By the Gerber type expansion joints the transmission of vertical loads is allowed through four bearing sliding devices. The comb joint is contained in the pavement thickness. By the expansion joint a space is obtained in the centre of the lower cantilever slab in order to allow entrance to the two bearing devices located inside for periodical inspection.

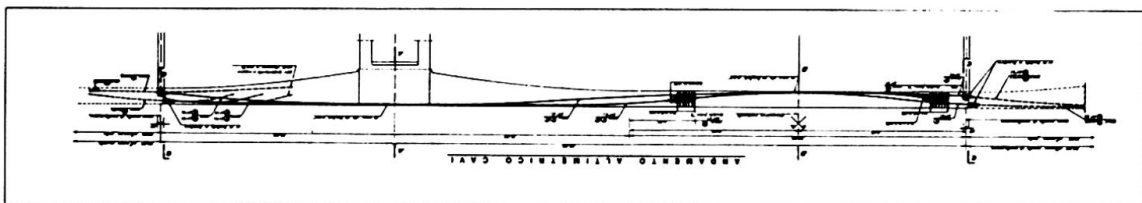

Fig. 2 Tendons profile

Furthermore room is provided to input a couple of jacks to enable the bearing devices to be uplifted if replacement is necessary. Thanks to the flexibility of the deck central section such work can be easily done without overcoming the acceptable strains.

The geometrical balance of baffles make the upper section of piers flexible



enough in relation to horizontal shifting and yet it reacts to deflections due to vertical loads. Piers are therefore able to absorb, with a slight increase in stress, longitudinal shiftings due to changes in the length of deck stemming from temperature, creep and shrinkage. At the same time the two baffles give a considerable flexural reaction under the action of vertical loads. They operate like a tight and stressed connecting rod located at a distance of 4.8 m between centres. It has been, thus, possible to get rid of all bearing devices overhead of piers and place one expansion joint only every 220 m.

The deck cross-section (Fig. 3) consists of a trapezium-shaped central part, 5.8 m maximum width and thickness ranging from 2.5 m at bearing to 1.1 in the span central area, as well as by side cantilever slabs of variable thickness.

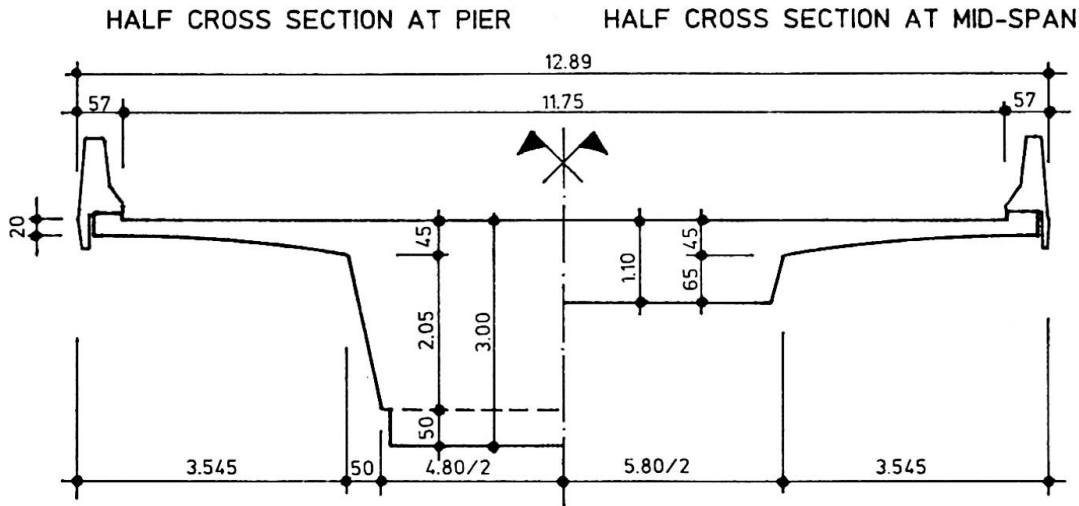

Fig. 3

The large structural thickness is a further guarantee of durability of the work. Thanks to the cooperating piers and to the favourable stiffness ratio between the sections at the supports and at midspan, 55 m span is reached, which is quite noticeable for this bridge type and this construction system, especially considering the low height of the midspan cross section. It is therefore solved the clashing necessity to guarantee a reduced deflection under live loads (3 cm) and to stand settling of foundation in order of 10 cm without overcoming acceptable strains of materials.

As to the rules in force the bridge is located in an area which has been classified as a 2nd range seismic zone (with 9 degrees of seismicity).

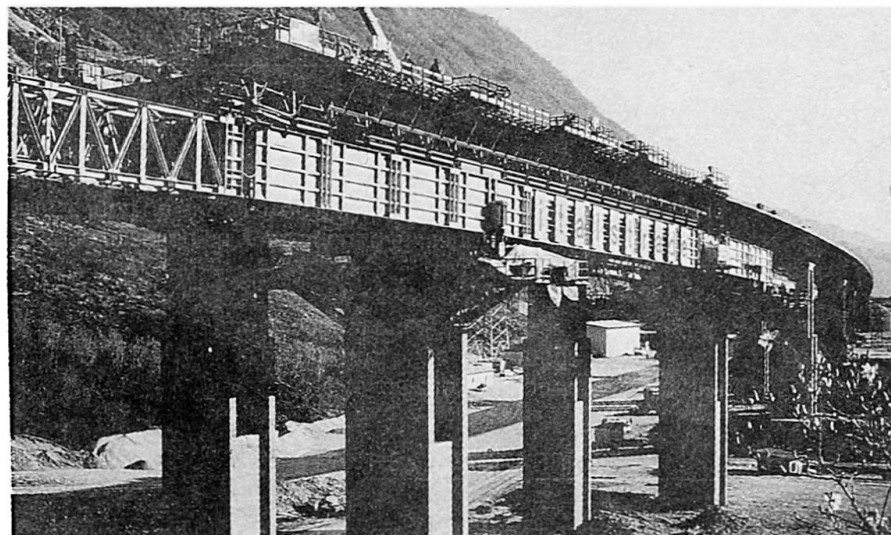

Fig. 4

Dynamic analysis carried out have proved that the flexibility of the end section of piers makes the main period of the structure higher than 1.3 seconds for lower piers and therefore outside the most dangerous seismic frequency range. The deck unit and the piers enable the structure to withstand seismic stresses assuring adequate safety resources without the need of special devices for seismic isolation.

2.2 Construction Technique

Casting is carried out on site by means of a mobile steel truss running beneath the beams, completely independent from the ground level, as it is equipped with self-launching panels (Fig. 4).

The whole reinforcement steel cage and sheaths for pre-stressing tendons are assembled off-site and then moved into position within the truss by a motorized steel transport device. The same device is equipped with a double-conveyor belt casting system which enables pouring of the whole span (approx. 530 sq.m.) in 6-7 hours time (Fig. 5).

This equipment was carried out by the Building Contractor just for this project. Actually, thanks to the length of the bridge, has been considered the opportunity to get a better span than the ones carried out with already available systems, bearing in mind, at the same time, the possibility to pay off opening and erection costs. In this connection it is to be remembered that the whole weight of the equipment (self-launching steel truss and motorized steel transport device) is approximately 14 MN.

The mobile steel truss is equipped with a speed-up steam curing plant which allows one span to be built every 4 days. Manpower incidence stands on levels that can compete with the most sophisticated execution systems.

The slab deck is used along the western carriageway up to pier 42. The remaining section consists of different structure and construction techniques. A special system of steel truss movement has thus been worked out for the change of carriageway which includes the lift on the deck with proper equipment, the transport with special multiple axle trolleys up to the abutment and the new placement on the first span of the east carriageway.

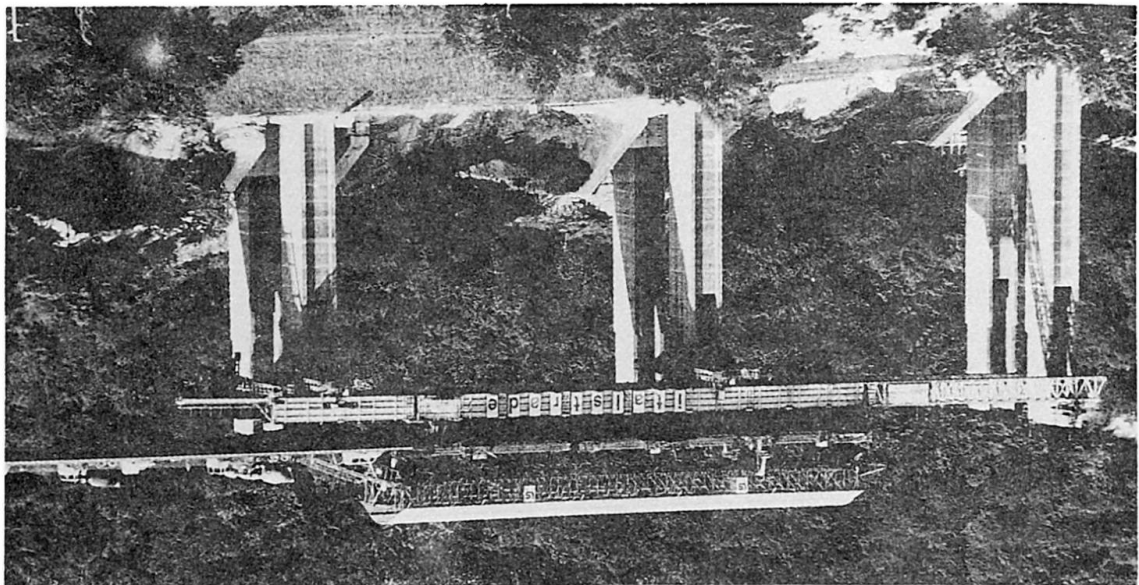

Fig. 5

2.3. Innovative Pre-Stressing Techniques

Longitudinal pre-stressing of the deck is executed with tendons composed of 27 0.6" strands and with a maximum starting tensioning of 5040 kN. The number of tendons has therefore been reduced as much as possible.

One of the most important innovations introduced with this structure is the coupling of cables at the construction joints between one span and the next one.



Instead of the usual coupling of anchorages, continuity of spans is obtained by overlapping pre-stressing tendons. The cables of each span enter the previously cast concrete structure taking a "U-turn". In such a way it was possible to distribute pre-stressing on more than one section avoiding the using of coupling anchorages and risks of sliding of anchorages wedges that would have very negative effects on duration of the structure (Fig. 6).

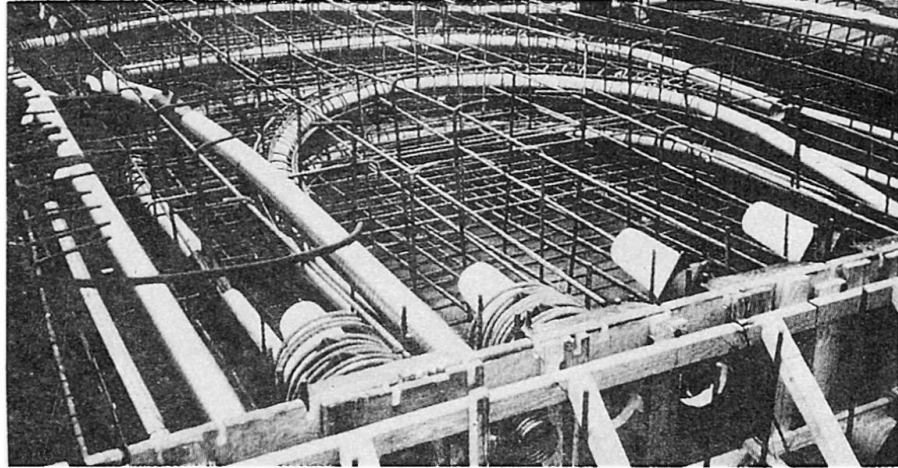

Fig. 6

Thorough studies were made on this matter to establish the minimum radius of curvature of anchor loops in relation to their diameter and the type of duct. In order to guarantee an even distribution of pre-stressing pressure and before the real stretching, every single tendon is lightly tensioned. Operations of inserting and stretching of cables placed in the first spans are controlled by endoscopes which allow to check the relation between theoretical forecast and real attitude.

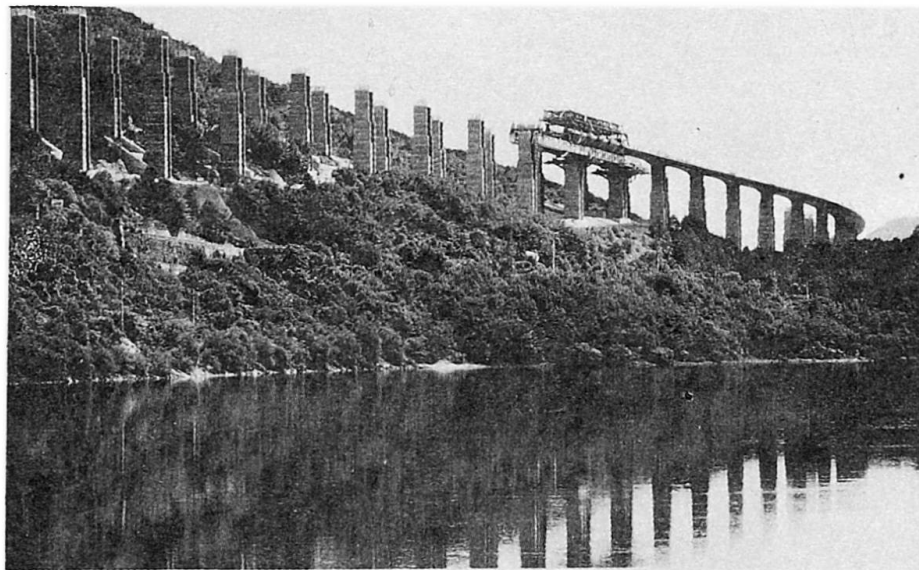

Fig. 7

3. CONCLUSION

The designing engineers' concern for geographical and morphological aspects of the area has enabled the realization of this civil work necessary to solve viability problems. Even though considerably long, it towers above the surrounding environment with the lightness of its geometric proportions (Fig. 7). For instance the outstretched and clear line of the viaduct, at the bottom of the valley, seems to underline, on purpose, the lake borders and the Millifret Mountain lower slopes.

This is a further confirmation that nowadays skillful builders must not give up experiment on big civil works nevertheless successfully defending the surrounding countryside.

Thermostressed State in Segmental Concrete Structures

Contraintes thermiques des voussoirs en béton armé

Wärmespannungen in segmentweisen Betonkonstruktionen

Michail GRANOVSKY

Civil Engineer
All-Union Res. Inst. of
Transp. Constr.
Moscow, USSR

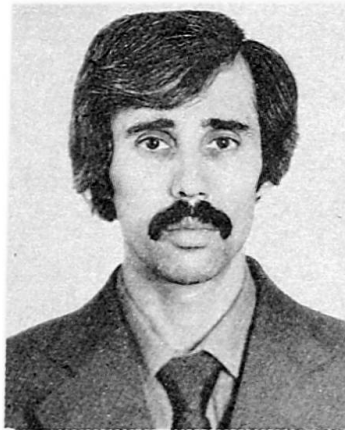

M. Granovsky, born 1960, graduated from Moscow Railway Engineers Institute, got his Cand. Sc. degree at the Res. Inst. of Transp. Constr. where he was involved in the problems of prediction and analysis of temperature regimes in transportation structures' base and body.

SUMMARY

The paper deals with the problems related to the development of a procedure for the analysis of temperature fields, stresses and deformations in segmental concrete structures in the course of their fabrication. Application of the procedure is demonstrated by the example of analysis of three-dimensional deformations of segments fabricated by the match casting method for bridge superstructures.

RÉSUMÉ

L'article décrit succinctement la méthode de calcul des champs de températures, de contraintes et de déformations dans les voussoirs en béton armé pendant leur mise en oeuvre. La présente communication fournit un exemple d'application de cette méthode, dans le calcul des déformations tridimensionnelles de voussoirs en béton armé, fabriqués selon le procédé de bétonnage bout-à-bout, et destinés à la construction de travées de pont.

ZUSAMMENFASSUNG

Der Aufsatz behandelt die Entwicklung von Berechnungsverfahren für Temperaturfelder, Wärmespannungen und -verformungen, die während der Fertigung in Segmenten abschnittsweise zu montierenden Betontragwerken entstehen. Der Einsatz des Verfahrens wird am Beispiel dreidimensionaler Temperaturverformungen von Brückensegmenten gezeigt, die gegeneinander gegossen werden.



1. METHOD OF ANALYSIS

Lengthy segmental concrete structures are being widely used nowadays for construction industry as a whole and for bridge building in particular. They are, first of all, bridge superstructures and piers field erected from separate segments with usage of reinforcing steel and glued joints. The abovesaid segments are precast constructions which fabrication is carried out by match casting method using purpose-designed forms. According to this method, which is rather popular in the USSR, end face of the earlier built segment is used instead formwork for concreting and hardening of the next segment, which would provide ideal coincidence of segments end faces when erecting a structure. In this case in the course of fabrication fresh concrete, in which intensive heat release due to cement hydration takes place, comes into contact with the "old" concrete of the previously fabricated structure. Similar situation occurs when erecting superstructure by cantilever method and constructing high bridges piers and pylons in a slipform, etc.

As a result of intensive processes of heat release and heat exchange, complicated spatial temperature fields, continuously varying with time, are being formed in the structures under fabrication, which induce growth of temperature stresses and strains. In some cases they may be of critical value and lead to cracks occurrence, structure's axis deviation from the design position and other negative post-effects. This is why prediction of such temperature fields and thermostressed state is considered to be challenging engineering problem, especially when designing extraordinary structures.

It should be noted that the problem under consideration, i.e. investigation of thermostressed state of various structures, has been a subject of extensive research and its results are available in the literature. But for our case, the problem seems to be specific, presenting significant difficulties for its solution and requiring development of purpose-designed procedure.

First of all should be considered the effect of cement exothermicity, which conditions largely temperature field to be formed. The intensity of cement heat release is known to have rather sophisticated dependence both on concrete temperature at a given moment and on all the previous "temperature history" beginning from concrete mix placing. This factor necessitates solution of two problems: that of heat conductivity and heat release one, being described by interdependent differential equations.

The structures to be constructed have often rather complex cross-sectional profile (box segments, slab-ribbed structures, etc.). On the other hand, the length of a segment to be cast has sizes, comparable with those of cross-section. All this requires the problem solution in three-dimensional formulation, otherwise it is of no avail.

And the last. It is evident that every time when concreting the next segment increment of design area takes place. When fabricating segments by match casting method the process seems to be more complex, as first takes place increment of design area when concreting a new segment in contact with the previous one, and then its decrease when separating segments. Temperature fields in a "new" segment and earlier built section of the structure have



strong reciprocal effect. The latter should be taken into consideration in the design scheme and analysis procedure.

This complicated problem may be more effectively solved by means of temperature fields and stresses simulation on the basis of advanced numerical methods and use of computing devices.

As a result of investigations conducted, special procedure and programs package related have been developed, which make possible calculation of three-dimensional non-stationary temperature field and spatial stress-strain state, induced by change of the field by the structure volume. The procedure is based on plotting of discrete design diagram and use of relevant numerical methods. Digitization is carried out by division of the design area into finite elements in the form of rectangular prisms. Calculation is performed in two stages. First the problem of non-stationary heat conductivity with internal heat sources is solved to determine temperature fields for the time of our interest. Afterwards thermoelasticity is determined and stresses and deformations (displacements), occurred under changed temperature field are calculated, assuming structure elastic behaviour.

Programs package features combination of two various numerical methods - finite difference method, being used for solution of heat conductivity problem and finite element method, being used for that of thermal conductivity. In our opinion it makes it possible to realize the both methods advantages and to obtain optimal complex, combining high effectiveness, simplicity and applicability. Finite element's simple form selected allows preservation of the same discrete scheme when changing thermal analysis for thermoelastic one. The difference is in unknown parameters: in the first case they are temperatures in the elements centres, while in the second one - their nodes displacements.

Significant advantage of the complex over the other ones is involvement of the procedure of cement heat release consideration. Advancements in the field of investigations of hardening concrete heat release phenomenon have been used for this complex development. The studies conducted showed that intensity of elementary volume heat release was proportional to maximum heat release by cement weight unit, to cement consumption per 1 m^3 of concrete mix, to portion of the cement, unreacted by the given time and to coefficient, depending on the given point temperature. In its turn, the quantity of unreacted cement depends, in a rather complicated way, on "temperature history" of elementary volume, beginning from the moment of concrete mix placement. So, when solving heat conductivity problem, for every time step is first determined heat release in every element, then change of its heat content due to released heat and heat exchange with the adjacent elements and, finally, change of temperature; afterwards the process is repeated by cycles.

The procedure allows consideration of nonuniform heat release by the structure volume, change of its time intensity and interdependence with temperature field.

The program developed makes it possible to change design area geometry by increasing or decreasing its dimensions, which allows development of mathematical model, featuring adequately technological process, consideration of temperature fields reciprocal effect in structure various sections, being cast at different time.



The programs package developed, not being universal, is meanwhile rather useful and effective means for calculation of temperature fields, stresses and strains in reinforced concrete structures, constructed by concreting by lifts, match casting or some other methods, when change of design area geometry should be considered for calculation. The program requires minimum of initial data, allows partial computerization of their preparation process, has high internal performance and quantitative capabilities. It has easy information input and exchange with external memory. Its programming language is FORTRAN.

2. ANALYSIS OF THERMAL DEFORMATIONS OF REINFORCED CONCRETE BOX SEGMENTS FOR HIGHWAY BRIDGES SUPERSTRUCTURES

On the basis of the procedure developed and program package there has been conducted a series of calculations to determine thermal regime and thermostressed state of reinforced concrete box segments, being constructed by match casting method, for highway bridges superstructures. The purpose of the calculations was to define the effect of thermal treatment various regimes on the mode and size of deformations, developing after segments cooling. Segments had 3,4 m depth, 12,5 m width of upper plate and 2 m length along the axis.

The problem is that coincidence of adjacent end faces of neighbouring segments, which should be provided by the technology used, i.e. due to matching of every next segment to be cast on the end face of the previously cast one, is frequently disturbed in practice. To a considerable extent it is related to thermal deformations growth. The matter is that in the course of hardening on a mould there are being formed temperature fields, which are significantly nonuniform by volume, as a result of thermal treatment as well as concrete self-heating due to cement exothermicity. Segment being at various stages of hardening, those fields are different. Complicated spatial stress-strain state is being developed in segments after their separation and temperatures gradual equalization. The abovementioned state induces, in particular, deformation of end faces, leading to disturbance of segments coincidence. When erecting a superstructure this results in segments turn relatively to each other, structure's axis deviation from the design position and differential size of a gap between adjacent faces. All the said effects negatively on the quality of glued joints used, aggravating their physical and mechanical properties.

To improve the quality of segments production optimal technological regimes should be selected, which would provide minimum thermal deformations or would compensate their growth by structural means. To this end, should be studied the nature of various thermal regimes effect on segments deformation, developing after cooling.

We set the problem basing on the assumption that after thermal treatment, i.e. by the moment of segments separation, their adjoining faces coincide completely. To find out mutual arrangement of segments during structure assemblage, first of all we have to obtain spatial pattern of deformed end faces. This pattern would be dependent on the thermostressed state, developing in every segment under change of temperature field - from that for separation moment to some constant by volume (equal to am-



bient air temperature). It should be noted that the absolute value of that constant is of no importance, as change of temperature by the whole volume of a free body by the same value results in the only uniform change of its linear dimensions, but doesn't change its stress-strain state. Besides, accounting for the assumption accepted, the problem of initial stresses by the separation moment, being rather complicated, may not be considered as a solved one. The object of our interest should be alteration of thermostressed state within two specified periods of time, leading to occurrence of deformations under consideration. The problem was formulated for elastic behaviour, without consideration of reinforcement. Concrete was considered as homogeneous isotropic medium with constant mechanical and thermophysical characteristics.

As per the procedure developed, analysis of temperature fields, being generated in segments by the moment of their separation, was conducted in several phases with alteration of design scheme when changing one phase for the other according to technological cycle stages. The said allowed consideration of mutual effect of segment-matrix and segment-match temperature fields. Various thermal treatment regimes were considered for the analysis. Temperature of heating, conditions of thermal exchange on the surface, etc. varied. (In all the cases heating formwork was on the segment's exterior surface, except the upper slab).

As a result of calculations data have been obtained on temperature distribution by the volume of each of two segments by the moment of their separation. Data on the magnitudes of thermoelastic displacements of points, being on the segments end faces, have been obtained as well. The latter characterize the nature and extent of end faces deformation after complete cooling of segments up to ambient air temperature, providing that temperature field at the separation moment is taken as initial state. Just those values show the possible degree of non-coincidence of adjacent segments end faces, resulting from temperature deformations, induced in the course of cooling. Here, the final objective of the calculations was determination of surface points displacement, but not stresses field, which is typical of the most problems.

Analysis of the results obtained showed that temperature fields in segments after thermal treatment completion have complicated non-uniform and pronounced three-dimensional mode, conditioned, to a considerable extent, by segments reciprocal effect. Here, temperature fields of the segment-matrix and segment-match differ significantly, which is obvious in Fig.1 and 2. As the structure and boundary conditions are symmetrical relatively to vertical plane, passing through segment's axis, then all the fields of temperatures and displacements appear to become symmetrical as well. That's why the fields, given below, are plotted for the half of a segment cross-section.

The results of thermoelastic analysis evidence that after segments cooling their end faces are being deformed and have complicated curved shape. Here, adjacent end faces of the neighbouring segments deform differently, which results in their non-coincidence. It should be noted that though analysis data describe completely three-dimensional mode of segments deformation, they don't give answer to the question about the position of



segments and gap size between them, when trying to assemble those segments with deformed end faces, joining them by means of cantilever method. To answer the above question complicated geometrical problem on tangency of two curved faces should be solved. We managed to obtain rather simple solution of the problem on the basis of graphoanalytical methods used. But its description cannot be presented because of the paper content limitation. Use of this procedure made it possible to determine for all the variants considered the angle of segments turn relatively to one another, which is the result of non-coincidence of end faces during segment assemblage, and to define deviation of superstructure's axis from the design position. Besides, fields have been plotted, featuring distribution of gap size (glued joint thickness) on the latter surface, one of which is given in Fig.3. Attention should be paid to the fact that there are given not absolute values of joint thickness, but values for this thickness excess over some minimum one, which would be in "tangential points, marked by circles.

As a result of investigations conducted all the necessary conclusions have been drawn and measures have been proposed to improve the technology for superstructure segments fabrication by match casting method.

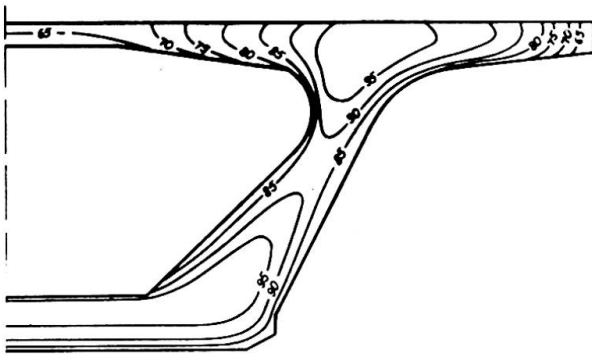

Fig.1 Temperature field in the middle section of a segment-matrix (isolines values are given in °C)

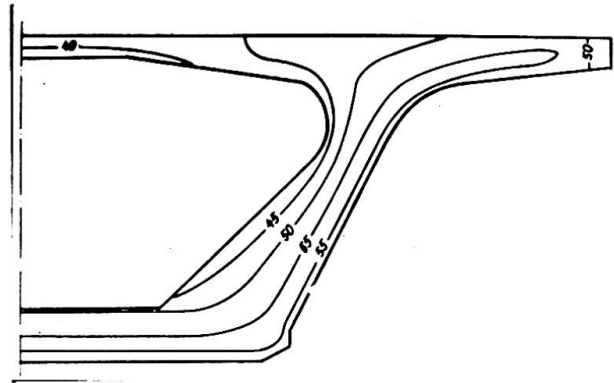

Fig.2 Temperature field in the middle section of a segment-match (isolines values are given in °C)

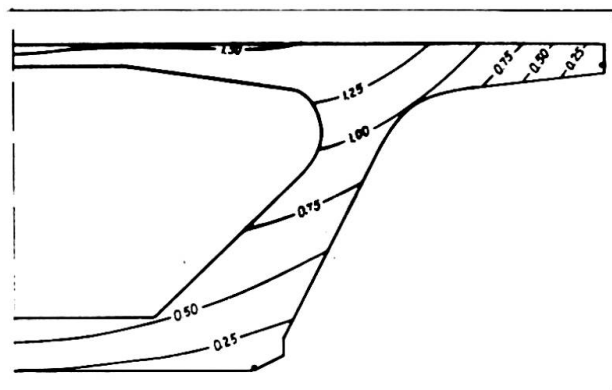

Fig.3 Distribution of glued joint thickness along its surface (isolines values are given in mm)