

**Zeitschrift:** IABSE congress report = Rapport du congrès AIPC = IVBH  
Kongressbericht

**Band:** 2 (1936)

**Artikel:** The arches of the Traneberg bridge in Stockholm

**Autor:** Kasarnowsky, S.

**DOI:** <https://doi.org/10.5169/seals-3199>

### **Nutzungsbedingungen**

Die ETH-Bibliothek ist die Anbieterin der digitalisierten Zeitschriften. Sie besitzt keine Urheberrechte an den Zeitschriften und ist nicht verantwortlich für deren Inhalte. Die Rechte liegen in der Regel bei den Herausgebern beziehungsweise den externen Rechteinhabern. [Siehe Rechtliche Hinweise.](#)

### **Conditions d'utilisation**

L'ETH Library est le fournisseur des revues numérisées. Elle ne détient aucun droit d'auteur sur les revues et n'est pas responsable de leur contenu. En règle générale, les droits sont détenus par les éditeurs ou les détenteurs de droits externes. [Voir Informations légales.](#)

### **Terms of use**

The ETH Library is the provider of the digitised journals. It does not own any copyrights to the journals and is not responsible for their content. The rights usually lie with the publishers or the external rights holders. [See Legal notice.](#)

**Download PDF:** 06.10.2024

**ETH-Bibliothek Zürich, E-Periodica, <https://www.e-periodica.ch>**

## IVb 4

### The Arches of the Traneberg Bridge in Stockholm.

### Die Gewölbe der Tranebergsbrücke in Stockholm.

### Les voûtes du pont de Traneberg à Stockholm.

S. Kasarnowsky,

Ingenieur, Erster Konstrukteur der Brückenbauabteilung der Hafenverwaltung, Stockholm.

The arch bridge over the Tranebergssund in Stockholm built during 1932 to 1934 combining railway and road bridge is at present the widest arch bridge in the world having a span of 181 m (fig. 1).

Dr. ing. *Dischinger* introduced as criterion for arch bridges the radius of curvature of a parabola  $\frac{l^2}{8f}$  passing through springing and crown, which he termed "the degree of boldness" of an arch.

It would be better to define this "degree of boldness" by introducing the actual radius of curvature at the crown as this value multiplied with the specific weight of the bridge material is almost identical with the normal stress in the crown due to dead weight. This radius of curvature at the crown of the Tranebergs bridge with a rise of 26,2 m measures 183 m and surpasses by about 7 m the corresponding radius of the new Mosel bridge at Koblenz and by about 50 m the radius at the crown of the Plougastel bridge at Brest.

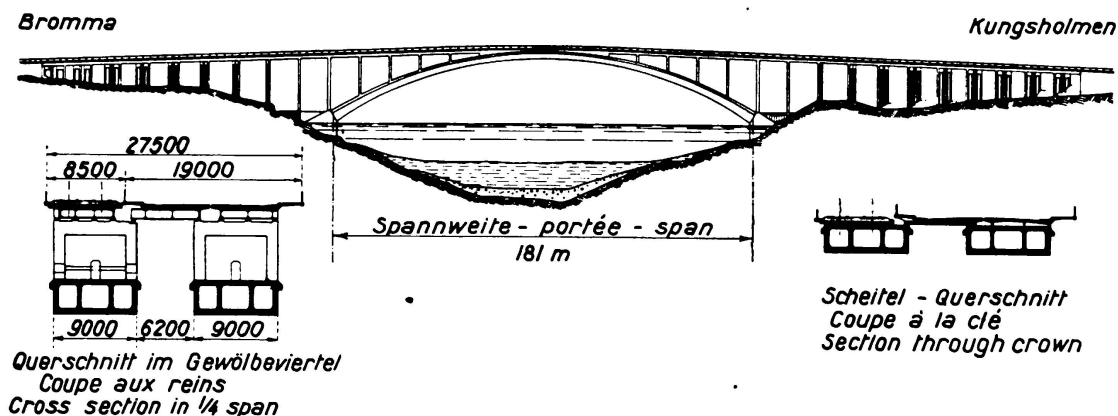

Fig. 1.

#### Bridge decking.

This bridge possesses two distinct tracks independent from each other. One decking is for road traffic only with a width of 19 m of which 12 m are for the road proper. The two side walks measure 2,5 m and 2 m respectively. Apart

from this there are two bicycle tracks each of 1,25 m. The other decking with a width of 8,5 m is used entirely by a double track suburban railway. The tracks being 3,5 m apart.

The design of the road decking was guided by the importance of not introducing too much weight on to the arches. The decking is composed of 10 welded longitudinal girders supporting a reinforced concrete slab 22 cm thick. The span of these girders measures 13 m and is the same as for the approach spans.

#### Conditions of loading.

*Live load:* for footpaths and bicycle tracks 0,4 t/m<sup>2</sup>, causeway 4 loading strips according to fig. 2a.

Suburban railway two trains according to fig. 2b.

The combination of these surcharges is identical to a loading factor of 7,5 t/m for one arch rib.

*Wind pressure:* 0,125 t/m<sup>2</sup>; *Temperature*  $\pm 16^{\circ}$  C.

*Shrinkage:* corresponding to  $-10^{\circ}$  C.

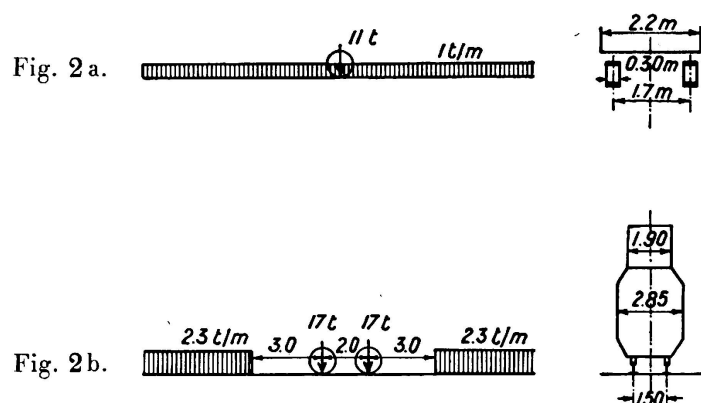

#### Permissible stresses and materials.

A permissible stress of 100 kg/cm<sup>2</sup> was allowed for normal loading composed of dead weight, live load,  $\pm 8^{\circ}$  C temperature and shrinkage. The maximum permissible stress of 120 kg/cm<sup>2</sup> was allowed for exceptional loading, being in addition to the normal loading, the influences due to  $\pm 8^{\circ}$  C temperature and wind pressure. The properties of concrete used for arch and arch foundations are shown in the following table:

Portland Cement kg/m <sup>3</sup>	Water Cement Ratio	Aggregates: Cement: Sand: fine shingle (7 to 30 mm): coarse shingle (30 to 60 mm)	Mean values of strength of test cubes kg/cm <sup>2</sup>			
			7 days	28 days	90 days	1 year
400	0,54	1 : 2,20 : 1,11 : 1,12	274	464	497	478
365	0,54	1 : 2,54 : 1,24 : 1,24	258	451	488	485

The thickness  $h_0$  of the crown was ruled by the following points:

- 1) *Safety against buckling in the plane of the arch.*

On account of the comparatively high compressive stresses (of 70 kg/cm<sup>2</sup> for dead weight only) it was found necessary to arrange for a stiff arch giving the

necessary safety against buckling in the plane of the arch. The lower limit of slenderness for a concrete post where buckling is likely to occur is known to be about 55. The free buckling length for an encastré arch of this type is about  $\frac{1}{3}$  of the span  $l$  and the radius of gyration about 0,37 of the thickness  $h_0$  at the crown, hence, the ratio of slenderness for the arch

$$\frac{0,33 l}{0,37 h_0} = 0,91 \frac{l}{h_0},$$

giving a least required thickness at the crown of

$$0,91 \frac{l}{h_0} = 55 \text{ or } h_0 = \frac{l}{60} \quad (1)$$

## 2) Additional stresses due to bending of the arch.

It is known that arches of wide spans in particular produce, due to deflection of the arch, additional stresses, which reduce the factor of safety considerably if the arches are slender<sup>1</sup>.

If  $X$  stands for horizontal thrust due to dead weight and live load and if  $\Delta$  indicates the deflection of the arch produced by live load, the additional bending moment due to deformation is approximately

$$c \times \Delta \cdot X \quad (2)$$

The coefficient  $c$  has the value 0,7 for the crown and  $\sim 1,0$  for the springing. (The deflection in  $\frac{1}{4}$  of the span is decisive for the springing.)

The calculation of actual deflection can be based on the deflection of the undeformed system if multiplied with a factor  $\Gamma$  derived from the following formula

$$\Gamma = \frac{\sigma_k}{\sigma_k - \sigma_n} \quad (3)$$

In this formula  $\sigma_k$  represents the buckling stress according to Euler out of equation No 1 and  $\sigma_n$  is the stress due to dead weight and live load. With *Young's* modulus of  $E = 210\,000 \text{ kg/cm}^2$  we receive for the Tranebergs bridge the values  $\sigma_k = 960 \text{ kg/cm}^2$  and  $\sigma_n = 76 \text{ kg/cm}^2$ , hence:

$$\Gamma = \frac{690}{690 - 76} = 1,12.$$

The most important deflections for arches of the type of the Tranebergs bridge can be calculated by using the following expressions:

$$\text{Crown} \quad \Delta = 0,000093 \left( \frac{p l^4}{J_0 E} \right) \Gamma \quad (4)$$

$$\frac{1}{4}\text{-span} \quad \Delta = 0,000122 \left( \frac{p l^4}{J_0 E} \right) \Gamma \quad (5)$$

( $p$  = live load per meter,  $J_0$  = moment of inertia of crown).

<sup>1</sup> See Kasarnowsky: Stahlbau 1931, No. 6.



For the Tranebergs bridge the above formulae with a live load of  $p = 7,5$  t/m supply values of deformations which are 2,6 cm for the crown and 3,3 cm for  $1/4$  span (see table). The horizontal thrust due to dead weight and live load for this bridge amounts to  $8588 + 782 = 9370$  t, hence the additional moments according to equation N<sup>o</sup> 2 are as follows:

$$\begin{aligned} \text{Crown } & 0,7 \cdot 2,6 \cdot 9370 \cdot 0,01 = 170 \text{ tm} \\ \text{Springing } & 1,0 \cdot 3,3 \cdot 9370 \cdot 0,01 = 310 \text{ tm} \end{aligned}$$

The additional stresses are not more than  $1,6$  kg/cm<sup>2</sup> or 1,6 % of the permissible stresses. Sufficient stiffness for the arch results from the thickness of the crown if based on formula (1) and the actual permissible stresses.

#### *Arch construction.*

The arch consists of two ribs 15,2 m apart. These ribs are of hollow section with two internal longitudinal partition walls. For a length of 54 m, symmetrical to the crown the thickness of the arch remains constant 3 m, and increases up to 5 m at the springing. The extrados of the arch has a continuous projection

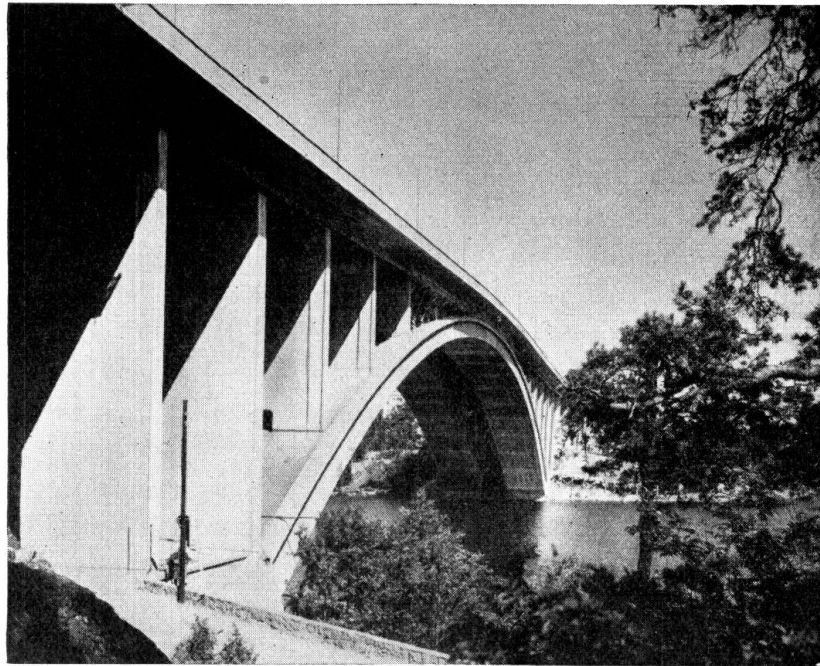

Fig. 4.

to give a more slender appearance to the whole arch (fig. 4). The width of the arch rib is constant, measuring 9 m. The following table contains the most important data of the cross section in crown,  $1/4$  span and springing:

Cross Section	Thickness of arch m	Cross sectional area m <sup>2</sup>	Moment of Inertia m <sup>4</sup>	Modulus of section m <sup>3</sup>
Crown . . . . .	3,00	12,85	15,52	10,30
$1/4$ span . . . . .	3,16	13,18	17,99	11,30
Springing . . . . .	5,00	22,05	69,93	28,00

The distribution of minimum and maximum stresses in the longitudinal direction of the arch is shown in fig. 3. It will be seen from this figure that no tension stresses are produced in the arch even for the most unfavourable conditions. The highest stress is found in a distance of 77 m from the crown amounting to 108,2 kg/cm<sup>2</sup> and is composed as follows

Dead weight . . . . .	64,3 kg/cm <sup>2</sup>
Influence due to lateral excentricity on account of dead weight . . . . .	1,0 „
Live load . . . . .	17,8 „
Influence due to lateral excentricity on account of live load . . . . .	1,1 „
Temperature — 16 <sup>0</sup> C . . . . .	9,9 „
Shrinkage (— 10 <sup>0</sup> C) . . . . .	6,2 „
Wind . . . . .	7,9 „
	Total 108,2 kg/cm <sup>2</sup>

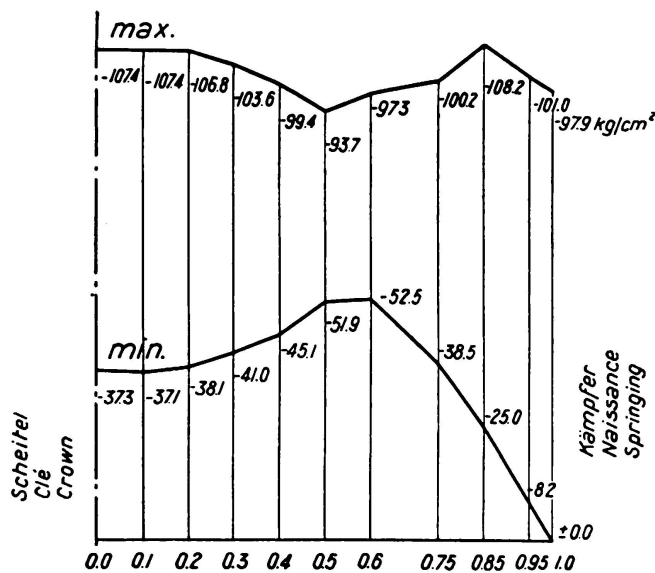

Verteilung der max. und min. Spannungen im Gewölbe.  
(Exceptionneller Belastungsfall)

Répartition des tensions max. et min. dans l'arc.  
(Cas de charge exceptionnel)

Distribution of stress minima and maxima in arch.  
(Exceptional case of loading)

Fig. 3.

The execution of each arch rib was done in two sections (fig. 5) and each section was composed of 10 parts pro half-span, with joints 1,2 m wide. The filling-in of concrete was done simultaneously at two corresponding places to avoid unsymmetrical loading of the arch formwork.

The concrete was prepared in a concrete factory and brought to site in special trucks with rotating drums of 1,25 m<sup>3</sup> capacity. From these trucks the concrete was poured into buckets and hoisted by cables to the site of concreting.

The total volume of concrete required for these arches was 2740 m<sup>3</sup> without foundations. The arches were reinforced with 62 kg of steel per m<sup>3</sup>. From this amount of steel 45 % were used for longitudinal and 55 % for cross reinforcement. The steel was of building steel quality, St. 50, with a lower yield limit of minimum 30 kg/mm<sup>2</sup> and an elongation of minimum 20 % of the standard length of testing specimens.

#### *Arch foundations.*

On both shores sound granite rock was found at the surface forming a natural load carrying bed for the foundations. The design for the foundations was carried out in such a way that the extreme fibre stresses were not more than 30 kg/cm<sup>2</sup>. In each foundation a hollow space was formed for the passing of water pipe lines of 1 m in diameter. The execution of the foundations was done in open dry pits, protected against the influx of water by circular cofferdams built for a maximum depth of water of 8 m.

#### *False-arch work (fig. 5).*

Four plated fixed steel arch ribs were forming the false-arch work for the construction of this bridge. These ribs were placed under the vertical walls of the arches and had a span of 172 m with a rise of 25,25 m. The cross section of this steel forms was constant throughout and consists of a web plate 2400 · 18 mm and four unequal angles 100 · 200 · 18 mm and two flange plates of 800 · 24 mm. The web plates were stiffened with two continuous channel sections NP 26. The material used for the false-arch work is high grade steel St. 52 with a lower yield limit of minimum 36 kg/mm<sup>2</sup> and an elongation of 20 % of the normal standard length of test pieces. Vertical full loading produced a maximum stress of 2210 kg/cm<sup>2</sup> in the false-arch work. (The dimensions of these arches were based on the required safety against buckling in the plane of the arches.)

The steel requirements for the false-arch work were as follows:

Steel St. 52 (plated arches) . . . . .	660 t
Steel St. 44 (bracings) . . . . .	195 t
Cast steel and rollers . . . . .	27 t
Steel St. 37 Tracks for shifting the false arches . . . . .	66 t
Total	948 t.

The erection of the false-arch work was done with the help of a floating gantry. See fig. 6.

#### *Execution.*

After the pouring of concrete was complete, 18 hydraulic jacks each acting with a pressure of 330 tons were inserted at the crown. With these hydraulic presses the arch was lifted at the crown by 17 cm and removed from the false-arch work over a length of 20 m, thus opening the crown by 11 cm at the extrados and 10 cm at the intrados. The horizontal thrust under these conditions was measured and found to be 6000 t which was 575 t more than the horizontal thrust calculated under the assumption that the centre line of

the arch coincides with the pressure line. After this 16 presses were applied at the springing, two for each bearing of the steel arch ribs. With this arrangement the false-arch work was lowered, thus releasing the concrete arch completely. The whole false-arch work was set on rollers and moved sideways 15,2 m into a new position for constructing the second arch rib.

The stresses in the arches were regulated according to the procedure of *Freyssinet* using 22 presses. A negative bending moment of 1590 tm and an excess of horizontal thrust 375 t was introduced at the crown. This enabled finally to keep the gap at the crown uniform 4 cm in width at the intrados and extrados. After filling the gap in the crown with mortar of 750 kg cement per m<sup>3</sup> the presses were removed and concrete was placed into their former positions.

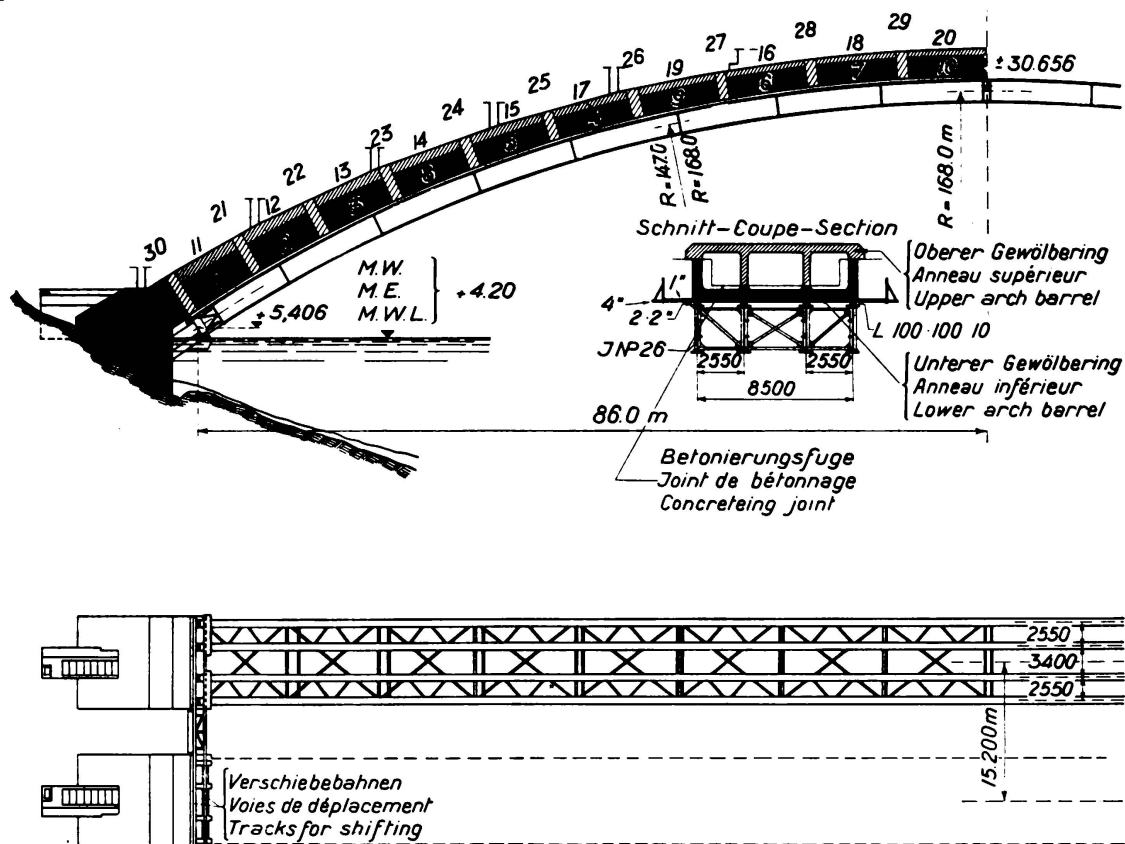

Fig. 5, 6.

### Test loading of the arches.

The static test was carried out with a superload of sand for the causeways and loaded waggons on the railway tracks. The total superload was 8,45 t/m, or 13% more than required by calculation. The sagging at the crown was measured to 28,7 mm of which about 10 mm were permanent deformations, similarly in  $\frac{1}{4}$  span a sagging of 29,7 mm was found with a permanent deformation 7 mm. At the same time stresses were measured at the springing with a *Huggenberger* deformeter giving a maximum stress of 17,7 kg/cm<sup>2</sup>, which coincides with the theoretically calculated stress for this place, using *Young's* modulus of  $E = 300\,000$  kg/cm<sup>2</sup>.

The dynamic testing was carried out with two 33,5 t tram car bogies, one on each track passing with a speed of from 15,9 to 43,8 km/h. The deformations at the crown were measured with a Stoppani oscillograph. The figures 7b c d show the diagrams of deformations in a form similar to influence lines. The maximum deflection (independent from speed) was measured to 1,7 mm which coincides with calculated results based on *Young's* modulus of  $E = 570\,000 \text{ kg/cm}^2$ . Finally horizontal and vertical oscillations of the arches were measured using for this purpose an astatic pendulum constructed by the author. The horizontal oscillations of the arches gave with an own frequency of 4 seconds of the instrument a frequency of 1,3 Hertz. Fig. 7e. The vertical oscillations of the arches were established by four men jumping rhythmically up and down causing this way a frequency of 2,0 Hertz. Fig. 7.

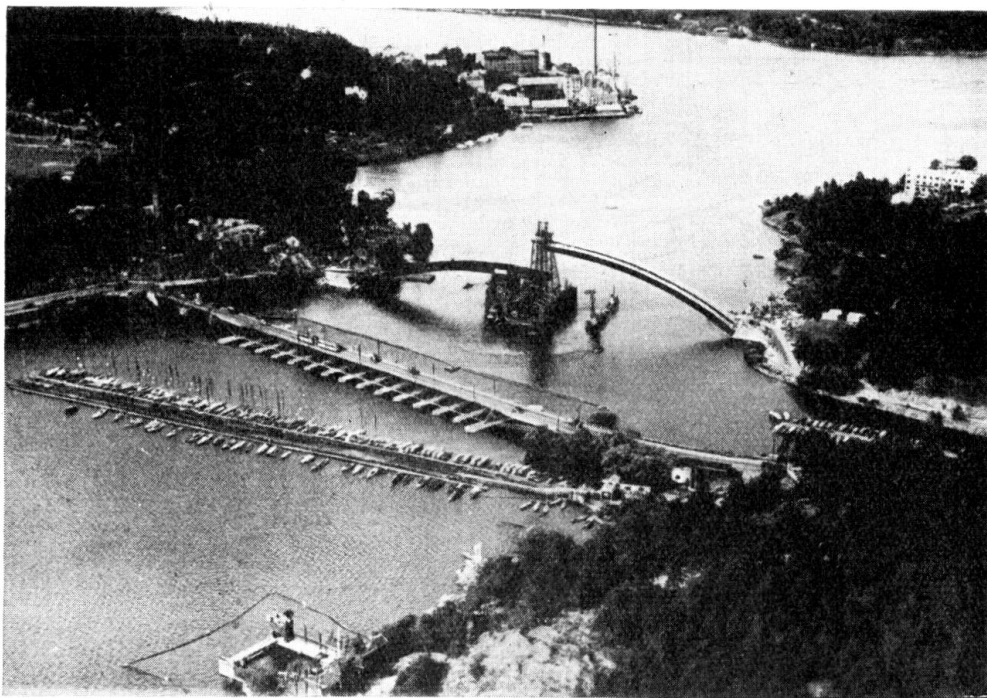

Fig. 7.

#### *Temperature.*

For the purpose of measuring the temperature in the concrete of the arches, thermostats were used at the crown and at the springing. Simultaneously were measured the temperature of the concrete, the temperature of the air in the hollow of the arches, the temperature outside and the vertical movements of the crown. To every centigrade corresponds according to calculation (based on a dilatation coefficient of 0,000010) a movement of the crown of 3,4 mm which figure was found to be correct according to tests.

These observations will still be carried out over a period of years with the purpose to establish finally the exact value of shrinkage of concrete in arches. With the recorded movements of the crown during the years 1934, 1935 it would be possible to calculate the shrinkage, corresponding to a decrease in temperature of  $-5^{\circ} \text{ C}$  for the southern and  $-3^{\circ} \text{ C}$  for the northern arch rib respectively.

The total costs for arch foundations, arches and false-arch work amount to 1.633.00 Kr. distributed as follows:

Foundations 4 nos. 1858 m <sup>3</sup> . . .	Kr. 255 000 or 15,6 %
Arches 2 nos. 5840 m <sup>3</sup> . . .	Kr. 634 000 or 38,9 %
False-arch work and bearing brackets	Kr. 744 000 or 45,5 %
<b>Total</b>	<b>Kr. 1633 000 or 100 %</b>

For the purpose of comparison the costs of a corresponding arch bridge in steel are given herewith:

Foundations . . . . .	Kr. 145 000
Superstructure and wind brazings 2100 tons à 850 Kr .	<u>Kr. 1785 000</u>
<b>Total</b>	<b>Kr. 1930 000.</b>

The costs of the road decking are assumed to be the same in both cases. This comparison shows that the concrete bridge in this case is more economical than a steel bridge for the same purpose.

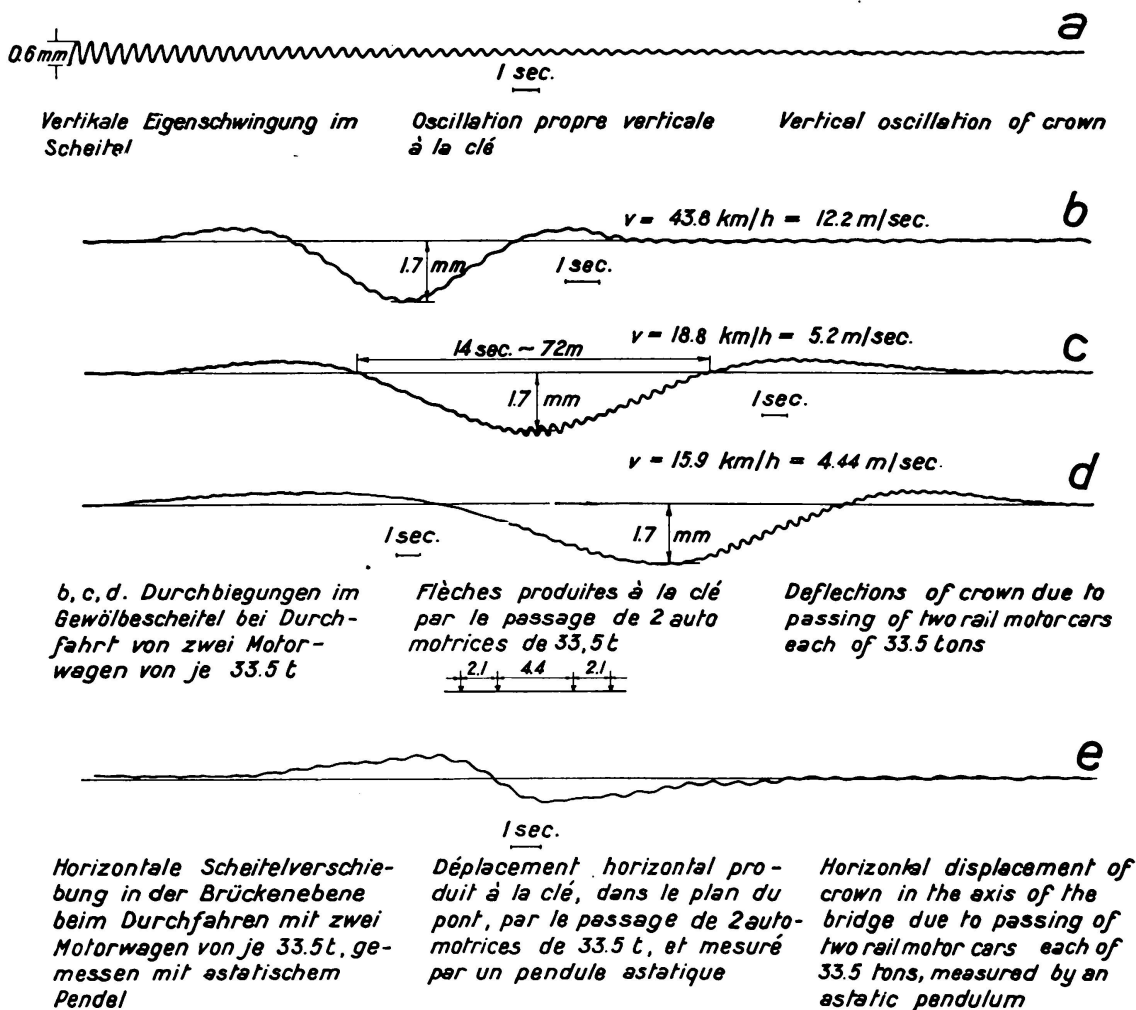

Fig. 8.

## S u m m a r y.

The experience made with the construction of the Tranebergs bridge allows for the following recommendations for designing arch bridges of wide spans.

The arch can be designed with a constant cross section between quarter-span and crown with a thickness of  $\frac{1}{60}$  of the span. The thickness of the arch at the springing can be 1,4 to 1,8 of the thickness in the crown. Free standing arch ribs should have a width of  $\frac{1}{28}$  to  $\frac{1}{30}$  of the span to establish sufficient safety against side buckling.

The unwanted stresses caused by the compression of the axis of the arch due to dead weight as well as a portion of the stresses due to temperature and shrinkage can be eliminated with the procedure established by *Freyssinet*.

While designing false-arch work special care should be taken to give this structure sufficient stiffness, as otherwise the removal and shifting causes great difficulties.

The construction of the false-arch work can be carried out in steel or timber.

Finally it may be mentioned that in case of competition between concrete and steel, the number of arches, which can be carried out with one false-arch work plays a decisive part. The higher the number of such arches the more economical the construction. The execution of one single arch construction can only be economical under particularly favourable circumstances.