

Zeitschrift: IABSE congress report = Rapport du congrès AIPC = IVBH
Kongressbericht

Band: 2 (1936)

Artikel: The effect of braking forces on solid bridges

Autor: Mörsch, E.

DOI: <https://doi.org/10.5169/seals-3200>

Nutzungsbedingungen

Die ETH-Bibliothek ist die Anbieterin der digitalisierten Zeitschriften. Sie besitzt keine Urheberrechte an den Zeitschriften und ist nicht verantwortlich für deren Inhalte. Die Rechte liegen in der Regel bei den Herausgebern beziehungsweise den externen Rechteinhabern. [Siehe Rechtliche Hinweise.](#)

Conditions d'utilisation

L'ETH Library est le fournisseur des revues numérisées. Elle ne détient aucun droit d'auteur sur les revues et n'est pas responsable de leur contenu. En règle générale, les droits sont détenus par les éditeurs ou les détenteurs de droits externes. [Voir Informations légales.](#)

Terms of use

The ETH Library is the provider of the digitised journals. It does not own any copyrights to the journals and is not responsible for their content. The rights usually lie with the publishers or the external rights holders. [See Legal notice.](#)

Download PDF: 06.10.2024

ETH-Bibliothek Zürich, E-Periodica, <https://www.e-periodica.ch>

IV b 5

The effect of Braking Forces on Solid Bridges.

Die Wirkung der Bremskräfte bei den massiven Brücken.

L'influence des forces de freinage dans les ponts massifs.

Dr. Ing., Dr. techn. h. c. E. Mörsch,
Professor an der Technischen Hochschule Stuttgart.

The consideration of braking forces is not only necessary for railway bridges but has been prescribed for motor car roads as well. The traction and initial forces due to acceleration of engines (locomos) act in the same way as braking forces. If the braking forces received no or only insufficient consideration in statical calculation it was for the lack of a proper method. A clear conception of the problem can only exist if the braking forces are *not* treated separately from the load by which they are produced. In the following a procedure will be shown illustrating how the influence lines for core moments can be altered to render them suitable for the inclusion of the additional influences due to braking forces. The alteration to influence lines varies according to the type of superstructure over the arches.

The braking forces are assumed to act, according to regulations, in the plane of the decking or along the top of rails. But, following the laws of dynamics, the braking forces produced at the decking and transmitted into the vehicle must act in the centre of gravity of the vehicle if they are to help in reducing the speed. By transferring this braking force from the point of action into the

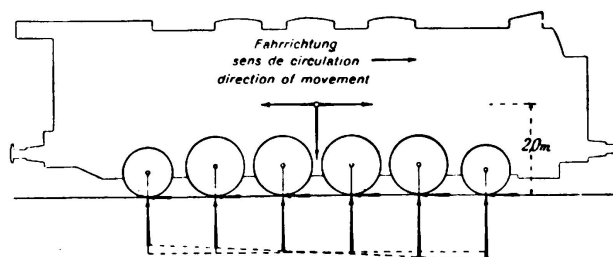

Fig. 1.
The forces acting on
a locomotive with
put-on brakes.

centre of gravity it is necessary for equilibrium to apply this force twice but reverse in sense, thus creating this way an additional couple. In reality the weight of the vehicle develops a tendency to be pushed forward and thus causes for unequal distribution on to the axles. Naturally slightly different moments would result from the influence lines for altered values of the axle loads. The regulations, however, allow this fine point to be neglected by placing the action of braking forces level with the bridge decking.

Strictly speaking, the braking forces would also be dependent on the gradient of the decking. The vertical axle loads on which the usual calculation of structures are based already embody a certain amount of braking forces if standing on an incline, to which they are not in a right angled position. A train, for instance cannot stand on an incline unless with locked brakes. The law of friction says that the angle formed between the resultant due to axle load and friction, and the vertical to the decking, at most be equal to the angle ρ of friction, and as is known, the coefficient of friction is expressed by $\mu = \text{tg } \rho$.

According to Fig. 2 the decking has an inclination φ to the horizontal and if the brakes are put on for a train moving down the braking forces S are developed. These, combined with the axle load P , give the resultant R which forms

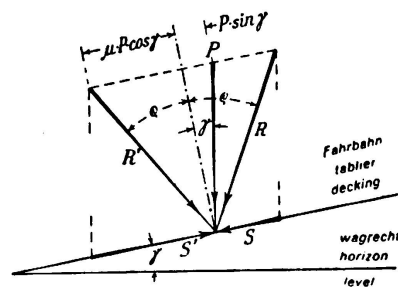

Fig. 2.

an angle ρ with the vertical to the decking. With this extreme position for R the value of the braking force is determined, which will have to be added to the vertical loads P :

$$S = P \cdot \cos \gamma \cdot \text{tg } \rho - P \cdot \sin \gamma.$$

For small values of γ this formula reduces to:

$$S = P (\mu - \sin \gamma).$$

If, however, a train is moving up the incline with its brakes on, the resultant R' has a reversed inclination and the braking force to be added to the vertical load P can be expressed as follows:

$$S' = P \cos \gamma \cdot \text{tg } \rho + P \sin \gamma$$

or correspondingly as above

$$S' = P (\mu + \sin \gamma).$$

The regulations for the German State Railways prescribe for $\mu = \frac{1}{7}$.

The axle loads of a vehicle with its brakes full on act under an oblique angle to the decking, accordingly on to the superstructure of an arch also. Since in general for the longitudinal direction of the bridge no distribution of loads through decking and superstructure is required (also according to DIN 1075 § 6) it *must consequently apply also for axle pressures somewhat inclined due to the braking action*. With this inference we receive the action of braking forces on to the axis of an arch as given in Fig. 3a and b for the two directions of a moving vehicle.

The oblique but parallel forces could be divided into two components at those places where they intersect with the axis of the arch. But with these forces P

shifted into the axis of the arch the use of the influence lines for care points would become intricate, as for such a procedure the distances between the forces would alter. To avoid these difficulties we proceed as follows:

From Fig. 3c it can be seen that it is of no importance for the external equilibrium conditions of a three hinged arch if the two forces P and S act in their original position or are moved parallel to any point of their resultant. This applies also when determining the moments M_x and M_k and M_o of two

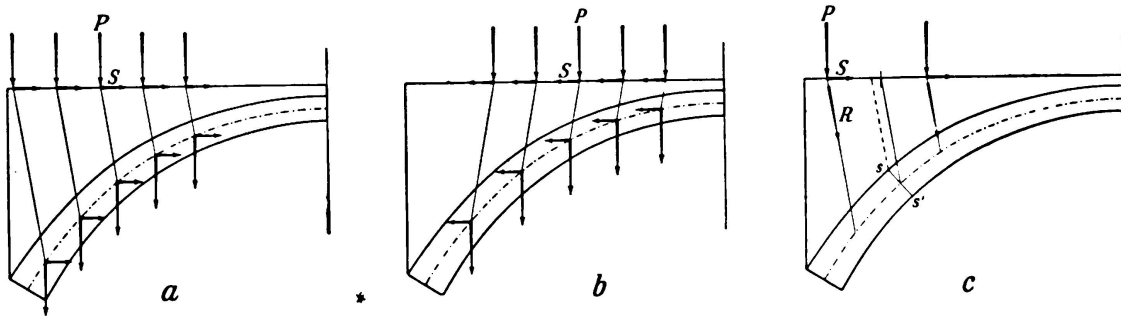

Fig. 3.

Compound action of axle loads and braking forces on arches with solid and open spandril construction with longitudinal partition walls.

hinged and fixed arches. If the loads P are left unchanged in their original position to the decking their action can be determined with the normal types of influence lines and the unaltered axle loads. It will only be necessary to find the alterations to bending moments, reactions etc. caused by the forces S .

It can be assumed as for the calculation with vertical loads only, that the oblique resultants R from P and S act directly on to the axis of the arch. The dividing line for the forces P and S left or right of an arch section $s-s'$ is therefore no longer established by the vertical through the centre of the axis in section $s-s'$, but that point of the decking through which passes a parallel line to the resultants starting from the intersection with the axis of the arch. This limit can be improved by a parallel through the upper edge of section $s-s'$. The position of the point of division changes with the direction of the braking forces.

For a unit force $S = 1$ moving over the decking, its particular action in the form of moments, reactions etc., can be determined and the calculated amount plotted as ordinates from a horizontal base line, for each particular momentary position of the moving force S . By this procedure we only receive an influence line for those braking forces for which the contributory amounts are identical with those of the axle loads P , in the same way as given by the normal influence lines. Since the braking forces always represent a definite portion of the axle loads, their contribution to the influence line ordinate can be added to the vertical axle loads, so that now only the improved or resulting influence lines for the axle loads require to be worked out. The position of the load division points for the resulting influence lines can be greatly changed in respect to the ordinary influence lines, but more accurate results are received than for separate influence lines with the same train loads positions giving the extreme values

with normal influence lines. Very often the difference is not considerable. Despite the above mentioned dislocation of the point of loading division for the loads left and right of the section, we are permitted to use the normal influence line as used for vertical loads to define the improved influence line. For statically determinate systems the abrupt stepping on the influence line only moves with the section for which the influence line is drawn. For statically indeterminate structures in which all influence lines can be interpreted and produced by funicular curves or funicular polygons, it would be necessary to lengthen the normal influence line by a tangent up to the dislocated positions of the loading division through which the new ordinates will be defined. For practical purposes, the influence lines for sections near the crown do not show any change of shape, because the dislocation is only small. This applies also to places where the curves are of small curvature. For the examples treated in the following, alterations to the influence lines were only required as shown in Fig. 17 and 19 for the influence lines M_k for the springing and abutment of fixed arches with curves with strong curvature.

According to the German Regulations braking forces do not require to be increased by an impact coefficient, whilst this is demanded for axle loads. This difference can be considered while working out the improved influence lines. If, for example, an impact coefficient of $\varphi = 1.1$ is chosen, and the braking forces be $\mu = \frac{1}{7}$ of the axle loads, then the ordinates of a normal influence line have to be altered by $\frac{\mu}{\varphi} = \frac{1}{7.7}$ of the corresponding ordinates of the influence line due to braking forces only.

If the decking has a steep angle φ of inclination, then the ordinates of the influence line due to braking forces only require to be multiplied by $\left(\frac{\mu}{\varphi} \mp \sin \gamma\right)$ before being added to the ordinates of the main influence lines, the sign $(-)$ stands for moving down and the sign $(+)$ for moving up on the incline of the decking. The resultant, composed of $\varphi \cdot P$ and the corresponding braking force forms an angle with the vertical to the decking which is sufficiently accurately expressed by the term $1 : \frac{\mu}{\varphi}$.

Since the ordinates of the influence lines complemented by the action of braking forces are composed of the contribution of P and S , forming the oblique resultant R , we receive exactly the same ordinates again by dividing the resulting axle pressures into the components P and S , in a plane parallel to the decking but at a lower level. The resultant influence line established in this way will be found to have shifted horizontally only to such an extent as the points of attack for P and S have moved. The computation of the influence lines leads to the same results.

Up to now we have chiefly been concerned with conditions for railway bridges, which are also to form the basis of the following examples. But for road bridges the DIN 1072 prescribe braking forces of $\frac{1}{20}$ of the weight of a uniformly distributed human crowd over the whole length of the superstructure,

or at least for each track 0.3 of the regulation motor lorry loads. The contribution of both influences to the action of braking forces can be determined with the separate influence lines for braking forces for care moments etc., since the points for loading division change unnoticeably little for the small value of $\mu = 1/20$. The stipulation that the whole length of superstructure has to be taken into account for the braking forces overlooks the fact that for fixed arches the influence lines for M_k due to braking forces have positive and negative areas. It does not involve much work for road bridges either to draw conclusive influence lines and to consider hereby the braking force equal to $1/20$ of the total human crowd and 0.3 of the load of regulation lorries.

The braking forces for simply supported girders.

The braking force $S = 1$ pertaining to a certain axle load creates an additional bending moment $M_x = -\frac{z}{l} \cdot x$ if acting to the right of section x , shown in Fig 4. If $S = 1$ is acting to the left of section x an additional bending moment $M_x = -\frac{z}{l} \cdot x + h$ is produced.

The influence line M_x , drawn hatched, is for braking forces only. The vertical off-set from the upper to the lower horizontal line lies below the border (zero

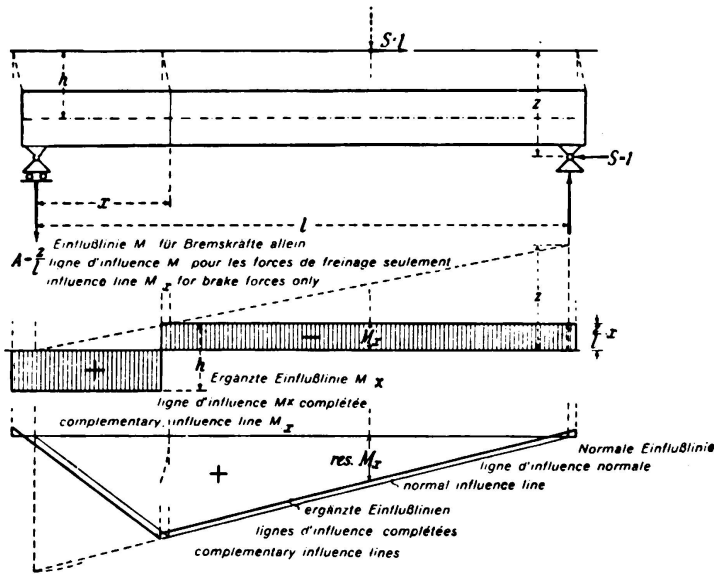

Fig. 4.

Influence line for bending moment M_x due to braking forces for a simply supported beam.

point of the influence line for section x) of the forces with applied brakes left and right of section x , in other words below that point of the decking which is defined by the oblique line under the angle $\frac{\mu}{\varphi}$ to the vertical, starting from the top of section x of the beam.

The final influence line M_x is shown in bold lines and already contains the contributions due to braking forces if the computation is made for axle loads multiplied by the impact coefficient φ .

In addition to the values of M_x there also exists an axial compressive force: $N_x = \mu \sum_0^x P$ for section X. Should this braking force be directed towards the movable bearing A then the opposite sign has to be applied, since the compressive force for section x changes into tension.

The braking force $S = 1$ produces for every position a constant shear force for the whole length of the beam, of $Q_x = -\frac{z}{l}$, thus causing the normal straight-lined influence lines for shear to move up or down for a constant amount of $\frac{\mu}{\varphi} \cdot \frac{z}{l}$, according to the direction of the braking action of the applied forces. The offset in the influence line for shear lies at the same place as that for the influence for moment M_x .

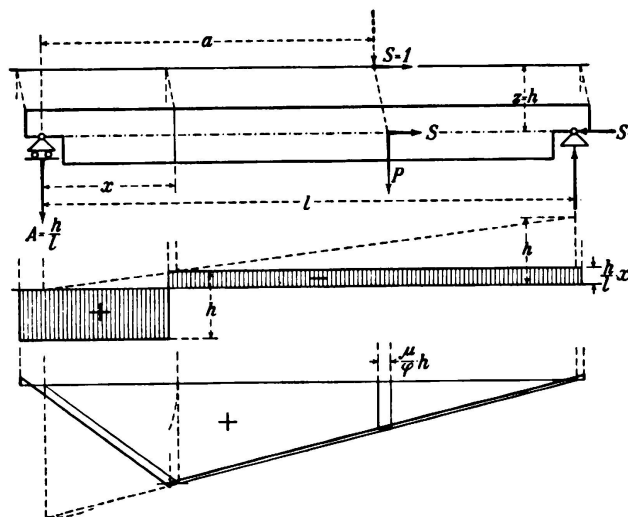

Fig. 5.
Influence line M_x for a simply supported beam with centres of bearings level with the axis of the beam.

If, as shown in Fig. 5, the beam has its bearing centres level with the axis of the beam, then $z = h$, and the steps of the influence lines M_x for braking forces only, have the heights shown in Fig. 5. Alterations to the normal influence line M_x due to the influences of braking forces, cause the two lines to move horizontally for an amount of $\frac{\mu \cdot h}{\varphi}$, so that they cross each other at the same vertical distance below the horizontal axis. The computation for the triangle of the slightly shifted influence line, but not considering the small offset at the point of the triangle, supplies the same values for bending moments as for stationary axle loads, in which case the influence of the braking forces is expressed by an axial force in the beam of $N_x = \pm \mu \sum_0^x P$.

The same shape of the final influence line for M_x including the effects of the braking forces, is obtained if the line of action of the braked axle load, standing at a, is produced to cross the axis of the beam, and at this place the force is divided into the vertical component P and the braking force S. For this position the force S is without influence, therefore it is only the load P, shifted into the

axis of the beam, which for $P = 1$ produces the ordinary, normal influence line M_x . If the ordinate of the moment is plotted directly under the load standing on the decking, we find the influence line for M_x moved to the left by $\frac{\mu}{\varphi} \cdot h$, in which case this influence line includes braking forces also.

The braking forces for continuous beams.

If the beam (Fig. 6) rolls on elastically fixed columns and has one end immovable we can accept the beam as being supported in points along its axis.

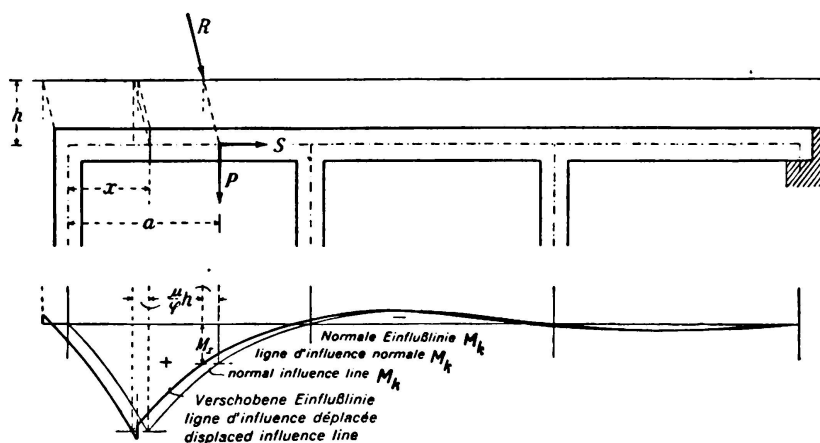

Fig. 6.

Influence line M_x for a continuous beam with centres of bearings level with the axis of the beam.

Based on the conditions laid down for the simply supported beam, it can be easily seen that the final influence line M_x is moved sideways by $\frac{\mu}{\varphi} \cdot h$ compared with the original influence line for M_x , giving the same values of moments as for stationary loads.

As regards *shear forces*, the same considerations apply as made for the resultant R of forces acting in the axis of the beam. We therefore receive an influence line for Q_x moved by $\frac{m}{\varphi} \cdot h$ in the opposite direction to the movement of the train compared with the normal influence line for Q_x . The offset between the upper and lower curve lies under that point of the decking which is cut out by a line drawn under the angle $\frac{\mu}{\varphi}$ from the top of section x . The computation of this influence line will hardly give different values than for stationary load.

If the beam supported on elastically fixed supports has no fixed bearing, then the influence of the braking forces for moments and shear will be quite considerable. The influence of every braking force can be obtained with the influence lines for moments and shear forces, provided the influence lines are based on a force $= 1$ acting in the axis of the beam. The additional influences of braking forces can therefore simply be added to the ultimate values for

moments and shear forces derived from stationary loadings. But the ordinary influence line can be improved by the complementary ordinates for braking forces, in which case we find moved the positions for the zero points of influence lines slightly moved.

For the *freely supported continuous beam*, not supported, however, in points of its axis, the consideration made in connection with Fig. 6 at first holds good, i. e. the force R is shifted into the axis of the beam, for which position the normal influence lines for moments and shear can be employed as for forces P acting there. But for this arrangement the forces S acting along the axis of the beam demand an additional distribution of bending moments and shear forces produced by the action of the couple $S(z - h)$ on to the fixed bearing (Fig. 2) causing a moment in the beam at this place. As explained above the action of this couple can be considered together with the ultimate values for M_x and Q_x received from stationary loads, or the influence lines for M_x and Q_x can be complemented directly for the action of braking forces. The additional contribution can be taken directly from the bending moment and shear force diagrams. The braking forces also cause a longitudinal force in the beam.

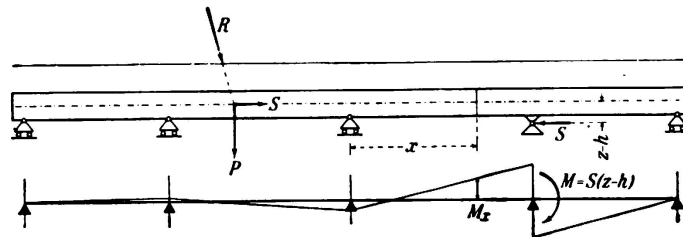

Fig. 7.

Diagram of additional bending moments due to a braking force S placed into the axis of the beam, for a freely supported continuous beam.

The braking forces for simple frames.

For fixed and two-hinged portal frames with horizontal brace and posts of equal height, the oblique force R of the braked axle loads are divided into components P and S at the intersection point with the axis of the brace. Any force $S = 1$ acting in the axis of the brace produces the same reactions and in consequence thereof a constant amount of additional moments for posts and brace. The braking forces out of any loading position can be collected in one force S , acting in axis of the brace, for which the additional stressing can be calculated. The influence lines for core moments can be complemented directly by contributions due to braking forces.

Braking forces acting on three-hinged arches.

The braking forces acting on such arches influence the stresses in the arch itself and in the abutments, in other words the influence lines for core moments, and the shear and normal forces as well are undergoing changes.

For the sake of distinctness the decking is given an exaggerated inclination in following figures.

Influence lines M_k for moments round the core of the arch.

Based on the considerations made for Fig. 3c, we allow in Fig. 8 the forces P and S to act in the decking and determine the moment M_k produced by a moving

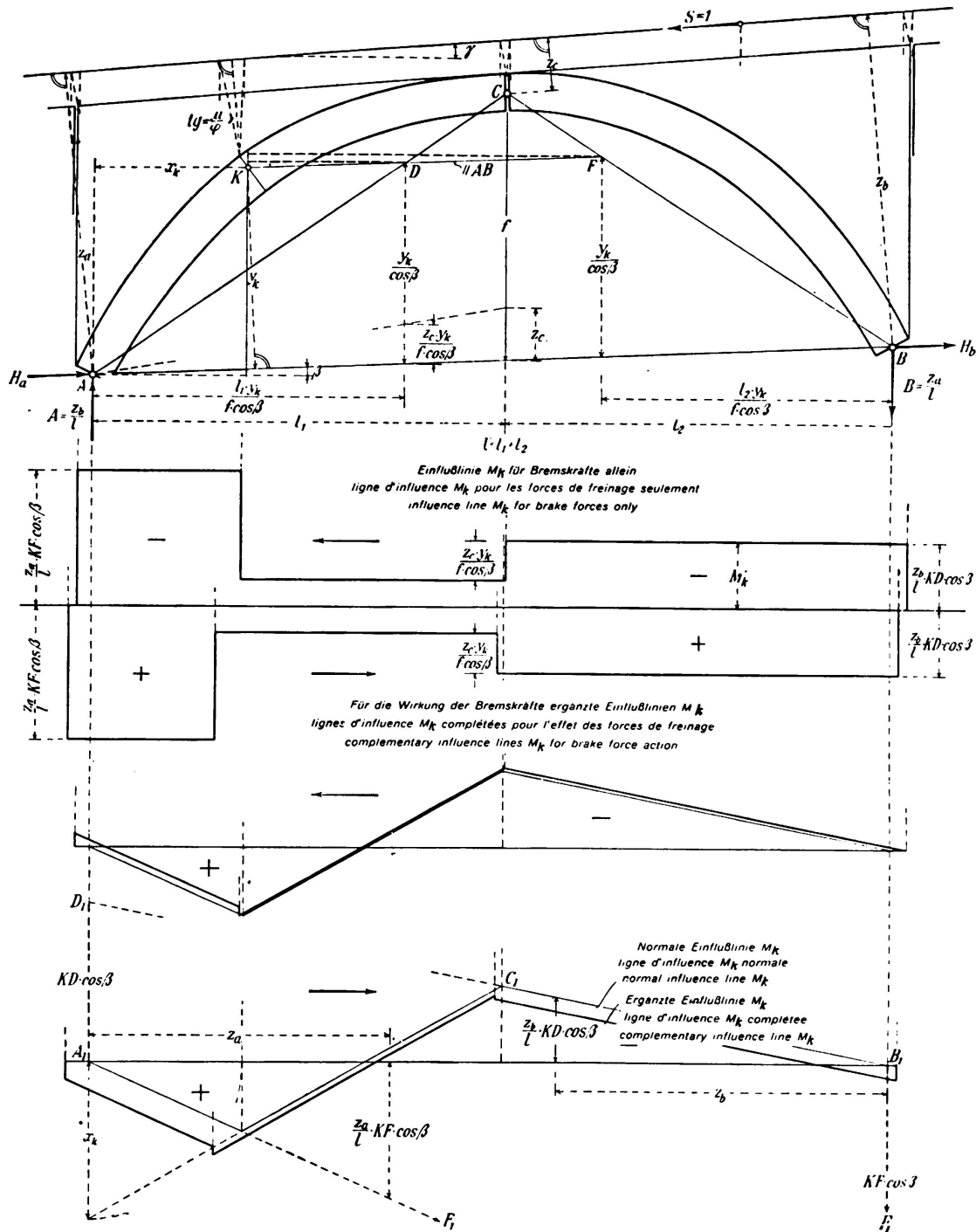

Fig. 8.

Influence lines M_k for braking forces for a three hinged arch with solid or hollow spandril construction with longitudinal partition walls.

load $S = 1$. For a section in the left half of the span we receive for $S = 1$ acting on the right half:

$$M_k = A \cdot x_k - H_a \cdot y_k = \frac{z_b}{l} \cdot x_k - \frac{z_b \cdot l_1 \cdot y_k}{l \cdot f \cdot \cos \beta} = -\frac{z_b}{l} \left(\frac{l_1 \cdot y_k}{f \cdot \cos \beta} - x_k \right)$$

hence $M_k = -\frac{z_b}{l} \cdot KD \cdot \cos \beta$.

$KD \cos \beta$ represents the horizontal distance between point D and the vertical through point K. The line KD is parallel to AB.

But if the force $S = 1$ is situated above the line KC and employing the proper terms for A and H_a the following expression for M_k is found:

$$M_k = \frac{z_b}{l} \cdot x_k - \frac{z_b \cdot l_1 \cdot y_k}{l \cdot f \cdot \cos \beta} + \frac{z_c \cdot y_k}{f \cdot \cos \beta} = -\frac{z_b}{l} \left(\frac{l_1 \cdot y_k}{f \cdot \cos \beta} - x_k \right) + \frac{z_c \cdot y_k}{f \cdot \cos \beta}$$

$$M_k = -\frac{z_b}{l} \cdot KD \cdot \cos \beta + \frac{z_c \cdot y_k}{f \cdot \cos \beta}$$

The term $\frac{z_c \cdot y_k}{f \cdot \cos \beta}$ signifies the offset between K and C in the influence lines for M_k for braking forces only, compared with the corresponding influence lines between B and C.

For $S = 1$ acting over the portion AK of the arch and starting the calculation from the right hand side we find:

$$M_k = -B(1 - x_k) + H_b \cdot y_k = -\frac{z_a}{l} \left(1 - x_k - \frac{l_2 \cdot y_k}{f \cdot \cos \beta} \right) = -\frac{z_a}{l} \cdot KF \cdot \cos \beta$$

wherein $KF \cos \beta$ represents the horizontal distance of point F from the vertical through k.

The total influence line for point K for braking forces only is therefore composed of the three offsets shown in Fig. 8. The sign of this influence line naturally changes if the movement of the rolling loads reverses to the right. In Fig. 8 we have also shown the influence line M_k for normal loads, containing already the contribution of braking action for a rolling load $= 1$. The ordinates of the influence lines for braking forces only for up or down movement respectively were multiplied by $\left(\frac{\mu}{\varphi} \mp \sin \gamma \right)$ and added to the normal influence lines.

The results are shown in bold lines, having offsets exactly at the same places as the influence lines for braking forces only. These offsets lie under such points of the decking as are established by lines drawn through the top of section K and the top of the crown at the separation of road metalling and concrete filling under an angle $1 : \frac{\mu}{\varphi}$ to the vertical to the decking. The position of the offsets changes with the sense of direction of the braking forces.

An unsymmetrical three-hinged arch with open spandril construction is shown in Fig. 9. For a construction of this kind all braking forces for loads acting on the open spandril work are transmitted either to point R or L (of the arch) where the decking construction connects up with the arch. Columns or cross

walls are by far too elastic to transmit directly the action of braking forces to the arches. The section containing the core point K belongs to the left half of the arch, situated below the open spandril portion. The braking force S is again acts in the decking of the bridge. For $S = 1$, acting only on the right half of the span, nothing is changed in respect to A , H_a and M_k and is the same as for Fig. 8. The same applies for the positions of $S = 1$ if situated within the portion KC of the arch, since such forces are only transmitted at L , which is to the right of the section under consideration. The influence line for braking

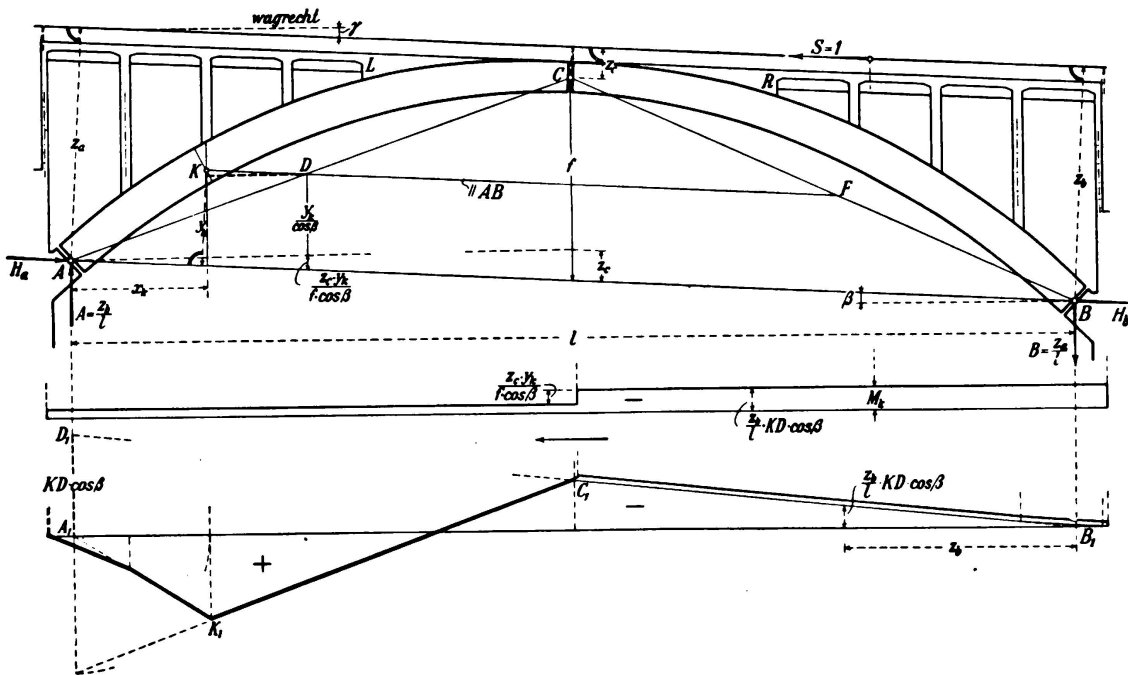

Fig. 9.

Influence lines M_k for braking forces for a three hinged arch with open spandril construction.

forces only is therefore composed of two portions only, see Fig. 9. In this figure, in light and bold lines respectively, normal and composite influence lines for M_k are also shown. If the section of the arch containing point K lies between L and C , then all equations given for M_k apply with reference to Fig. 8, and therefore the stepped influence line M_k for braking forces only has the same shape as for arches with solid spandrels.

It suffices for practical purposes of stress calculation and dimensioning to complement the normal influence lines for M_k for braking action simply by increasing the positive and negative triangles accordingly.

Influence lines M_k for abutments and intermediate piers.

Provided the braking forces have their origin in axle loads placed over the arch, the core moments in the abutment or intermediate piers are determined by the forces passing through the hinges at the springing. These forces are independent of the type of superstructure, therefore the influence lines given by Fig. 10 and 11 are applicable for arches with solid and open spandril construction.

With the denominations of Fig. 10 we receive for $S = 1$ acting to the left on the left half of the arch:

$$B = \frac{z_a}{l} \quad \text{und} \quad H_b = \frac{z_a \cdot l_2}{l \cdot f \cdot \cos \beta}$$

and hence for a section of the right hand abutment:

$$M_k = B \cdot x_k - H_b \cdot y_k = -\frac{z_a}{l} \left(\frac{l_2 \cdot y_k}{f \cdot \cos \beta} - x_k \right) = -\frac{z_a}{l} \cdot KD \cdot \cos \beta$$

The point D is defined by a line through K, parallel to AB and the line BC,

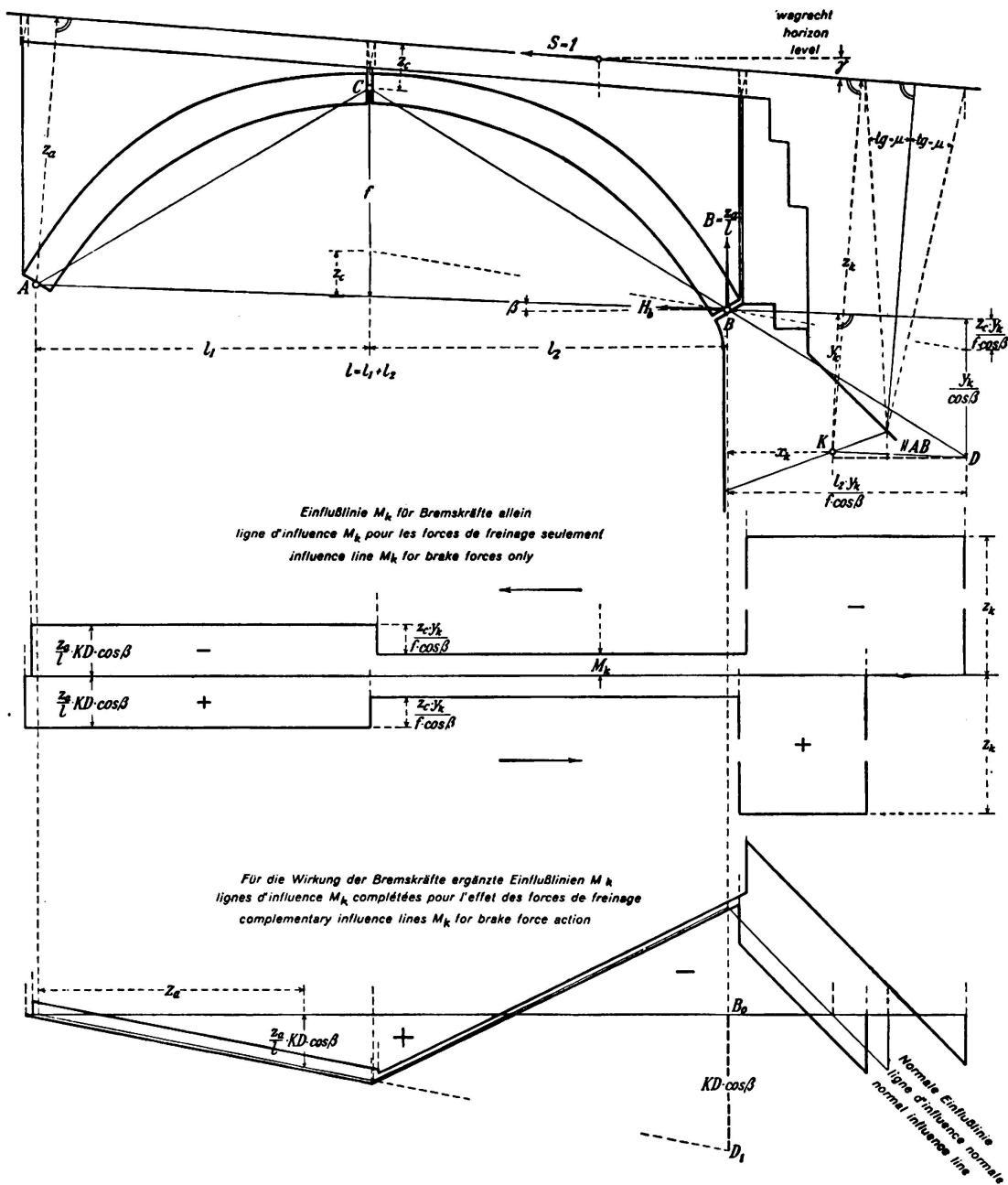

Fig. 10.

Influence lines for braking forces for a section through an abutment.

the term $KD \cos \beta$ marks the horizontal distance of D from the vertical through K.

For $S = 1$ acting on the right half of the arch we receive:

$$B = \frac{z_a}{l} \quad \text{and} \quad H_b = \frac{z_a \cdot l_2}{l \cdot f \cdot \cos \beta} - \frac{z_c}{f \cdot \cos \beta} \quad \text{and hence}$$

$$M_k = - \frac{z_a}{l} \left(\frac{l_2 \cdot y_k}{f \cdot \cos \beta} - x_k \right) + \frac{z_c \cdot y_k}{f \cdot \cos \beta} = - \frac{z_a}{l} \cdot KD \cdot \cos \beta + \frac{z_c \cdot y_k}{f \cdot \cos \beta}$$

If the force $S = 1$ acts directly over the abutment, we receive, with the considerations made for Fig. 30, $M_k = -1 \cdot z_k$. The braking forces exert in fact an unfavourable action on to the abutments, since they cause an increase in earth

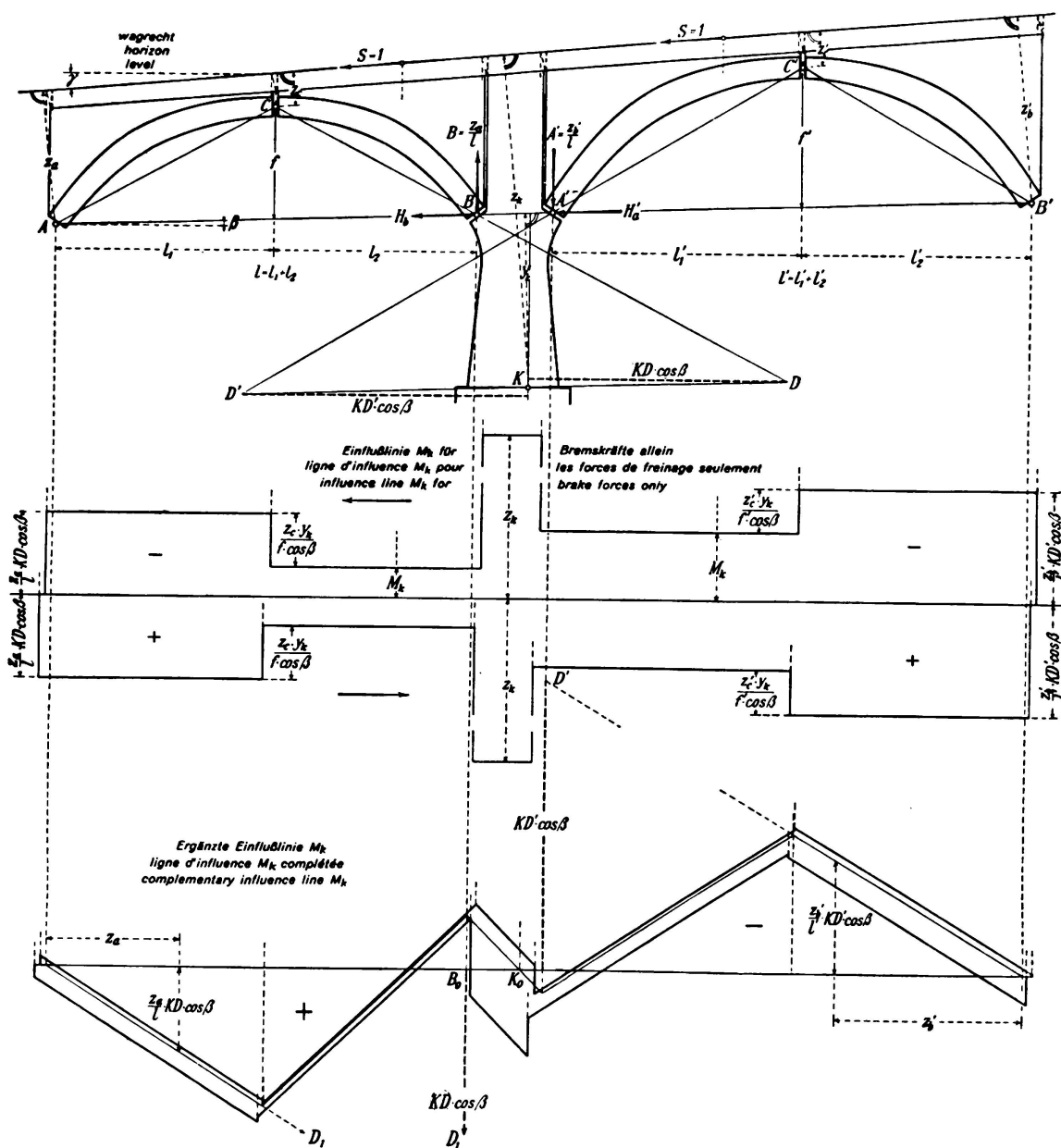

Fig. 11.

Influence line M_k for braking forces for a section through an intermediate pier.

pressure on the retaining wall in front of the dilatation joint. Fig. 10 shows the stepped influence line M_k for braking forces only and the complemented normal influence containing the contribution due to braking forces. These influence lines are for the section passing through K in the abutments. According to DIN 1075 the calculation for abutments and piers shall be made for braking forces not increased by an impact factor, hence in this case $\varphi = 1$. For movement on the down and up-gradient, the ordinates of the influence line composed of straight lines require to be decreased or increased by $(\mu \pm \sin \gamma)$ — times the amount of the ordinates of the stepped influence line for braking forces. The influence lines M_k of Fig. 11 for a section of an intermediate pier are easily derived from Fig. 10 by assuming the intermediate pier to take once the place of the right hand bearing of the left span l and once that of the left hand bearing of the right hand span l' .

Influence lines for normal and shear forces for the hinges of the arch.

The ordinates of this stepped influence line for braking forces only are determined in the easiest way by graphical construction for unsymmetrical arches; for this purpose the force $S = 1$ is placed on the left and right half of the arch and for these positions the reactions at the springing hinges can be determined from the triangle of forces. The reactions will then be divided into two components, one vertical and the other horizontal in respect to the joint of the hinge. The type of spandril construction has no influence on the shape of the influence line.

The polygon of forces (1) in Fig. 12 applies for the case of force S standing over the right half of the arch and the force polygon (2) in case the force S is situated over the left half of the arch. The components N_c and Q_c of the force acting at the hinge of the crown can be determined by the reaction at the springing of the unloaded side of the arch. The normal influence line for forces in the hinges are complemented for braking action (see Fig. 12) by adding $\left(\frac{\mu}{\varphi} \pm \sin \gamma\right)$ — times the value of the ordinates of the stepped influence lines. The joint of the hinges shall, according to DIN 1075 be right angled to the dead-weight pressure line of the arch due to dead weight.

For symmetrical three-hinged arches with horizontal decking it is easy to determine the ordinates of the stepped influence line.

Braking forces on two-hinged arches.

First the influence line for horizontal thrust due to braking forces has to be worked out, this line established, all other influence lines for core points can be derived from it.

Influence line for arch thrust H_a .

The form of an arch deviates very considerably from the pressure line produced by braking forces. It is therefore permissible to neglect the deformations

caused by normal forces N_x , which in this case are composed of tensile and compressive forces, hence we can write for the arch thrust:

$$H_a = \frac{\int \frac{M_0 \cdot y \cdot ds}{J}}{\int \frac{y^2 \cdot ds}{J}}$$

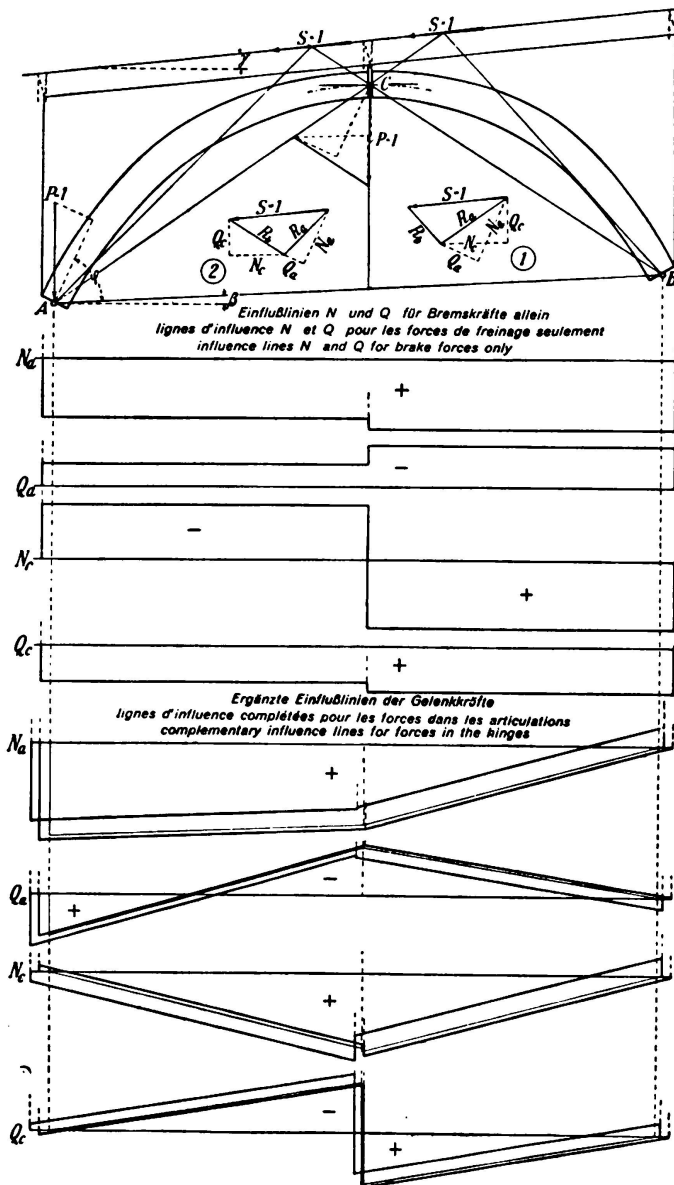

Fig. 12.
Influence lines for normal and shear forces due to braking forces, for the hinged joints of a three-hinged arch.

For the statically determinate basic system we receive with the designation given in Fig. 13 for a braking force $S = 1$ acting in section a:

for sections x between O and a $M_0 = \frac{z_h}{l} \cdot x$

for sections x between a and l $M_0 = \frac{z_h}{l} \cdot x - z$

hence with these terms the following expressions are obtained:

$$\int \frac{M_o \cdot y \cdot ds}{J} = \int_0^a \frac{z_b}{1} \cdot \frac{x \cdot y \cdot ds}{J} + \int_a^l \left(\frac{z_b}{1} \cdot x - z \right) \cdot \frac{y \cdot ds}{J} = \frac{z_b}{1} \int_0^l \frac{y \cdot ds}{J} \cdot x - \int_a^l \frac{y \cdot ds}{J} \cdot z$$

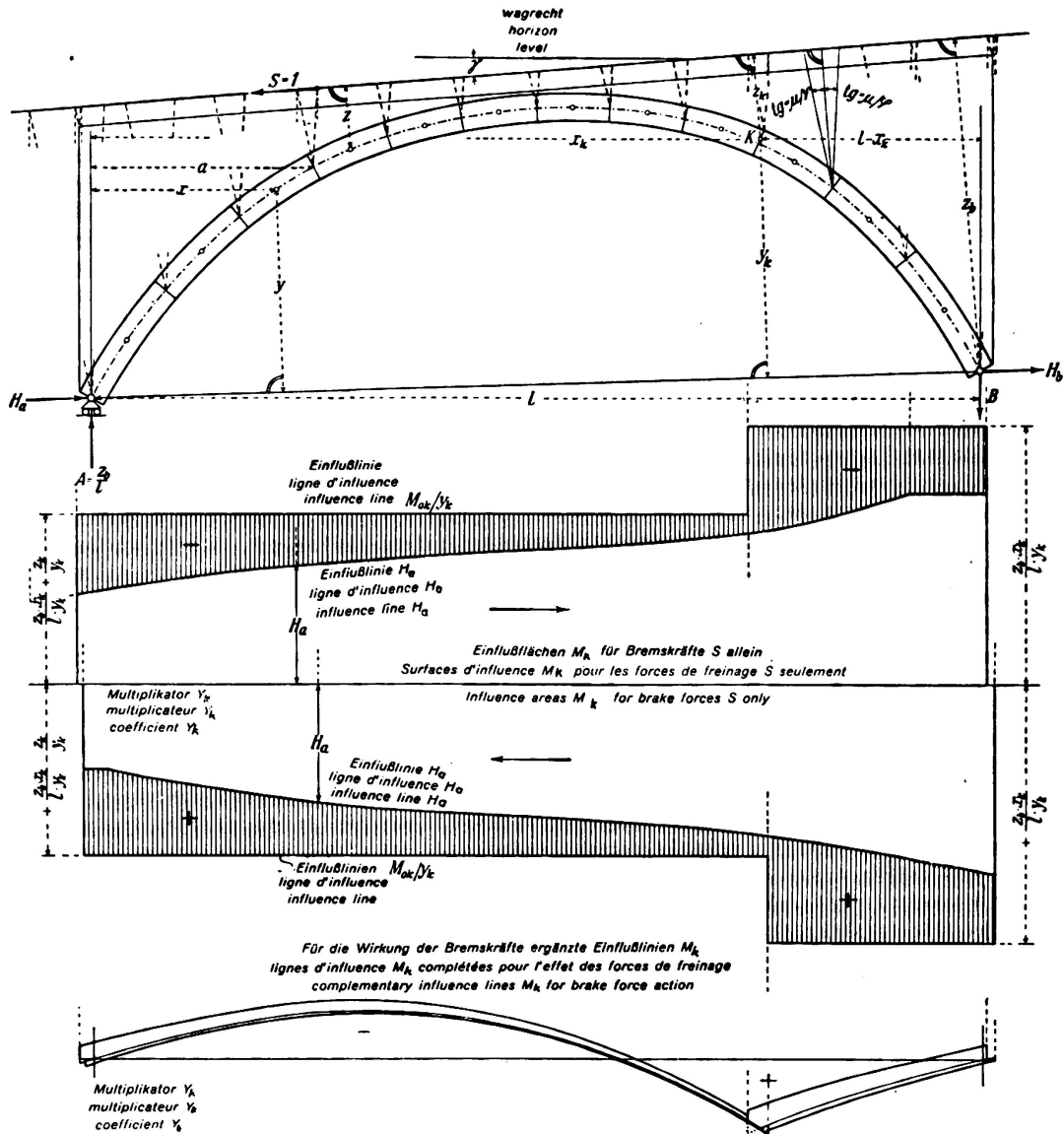

Fig. 13.

Influence lines H_a and M_k for braking forces for a two-hinged arch with solid spandril or spandril construction consisting of longitudinal partition walls.

For finite portions s of the arch, and introducing $w_y = \frac{y \cdot s}{J}$ for the elastic weights, we receive:

$$H_a = \frac{\frac{z_b}{1} \sum_0^l x \cdot w_y - \sum_a^l z \cdot w_y}{\sum y \cdot w_y}$$

The summations of the nominator are quite easy to calculate, particularly the second summation is best done by starting at the right end by pushing the

section a forward to the left step by step, from element to element. The ordinates of the influence line H_a thus received, are plotted from a horizontal line at those particular points where the line from the axis point of the section a under an angle $\frac{\mu}{\varphi}$ to the normal of the decking crosses the horizontal base line.

According to the change in the direction of the braking forces a slight displacement takes place between the ordinates and the influence line.

The influence line for a core moment is given by the following relation

$$M_k = M_{Ok} - H_a \cdot y_k = y_k \left(\frac{M_{Ok}}{y_k} - H_a \right)$$

in the form of the difference between the area of the influence lines H_a and M_{Ok}/y_k .

The computation of the hatched influence line in Fig. 13 has to be done by multiplying the results by y_k . The influence line M_{Ok} for braking forces only is a stepped line, since for forces $S = 1$ to the right of point R we receive

$$M_{Ok} = A \cdot x_k = \frac{z_b}{l} \cdot x_k,$$

and for $S = 1$ left of K the influence line for braking forces is expressed by

$$M_{Ok} = A \cdot x_k - z_k = \frac{z_b}{l} \cdot x_k - z_k$$

In Fig. 13, bottom, the normal influence line $\frac{M_k}{y_k}$ for a section belonging to the right half of the arch is shown in these lines. The bold lines however are a composition of the normal influence line $\frac{M_k}{J_k}$ by adding $\left(\frac{\mu}{\varphi} \pm \sin \gamma \right)$ — times the value of the ordinates of influence lines for braking forces only.

For the normal influence line H_a it is of no practical avail if the points of attack for $P = 1$ coincide with those for $S = 1$, in other words are no longer placed directly vertically above the dividing points. Vertical offsets are formed directly under point K between the two curves. The location of these offsets coincides with the stepping in the influence line M_{Ok} for braking forces.

For symmetrical arches and those unsymmetrical arches in which the line through the hinges at the springing is parallel to the decking, the ordinates of the influence lines H_a are complementary for symmetrically placed elements (dividing points) in respect to l. It therefore suffices to calculate the ordinates only for one half of the bridge.

In connection with Fig. 3c it was found that the resultant out of axle load and braking force can be divided into its components again at any point of its line of action and that these components produce the same compound action on any point of a statically indeterminate system as if the resultant itself were acting. On account of this, in the present case, the oblique axle loads can also be applied in a plane parallel to the decking for instance a parallel plane tangent to the crown, where these forces will be divided into the components P and S.

If the calculation as described is carried out for H_a and M_k due to braking forces S only and finally the composite influence line is formed for core moments, we find that the influence lines thus produced are shifted slightly sideways by the line of action of the braked forces when crossing the two parallel planes. The computation of the influence lines thus produced furnishes the same limit values.

For arches with open spandril construction it is not possible to choose arbitrarily the position of this reference plane, since the braking forces for an open arch superstructure are transmitted through the decking to the points L and R , where they act directly on to the arch, the decking being rigidly anchored to the arch at these points. To receive the correct moments M_o for the statically determinate basic system it is necessary to transfer the braked axle loads to the central plane of the decking and this applies also for the portion in which the decking is resting directly on the arch. In this plane the forces are divided into the components P and S , so that for the force $S = 1$ the axle distances of the loads have not to be changed while computing the final influence line.

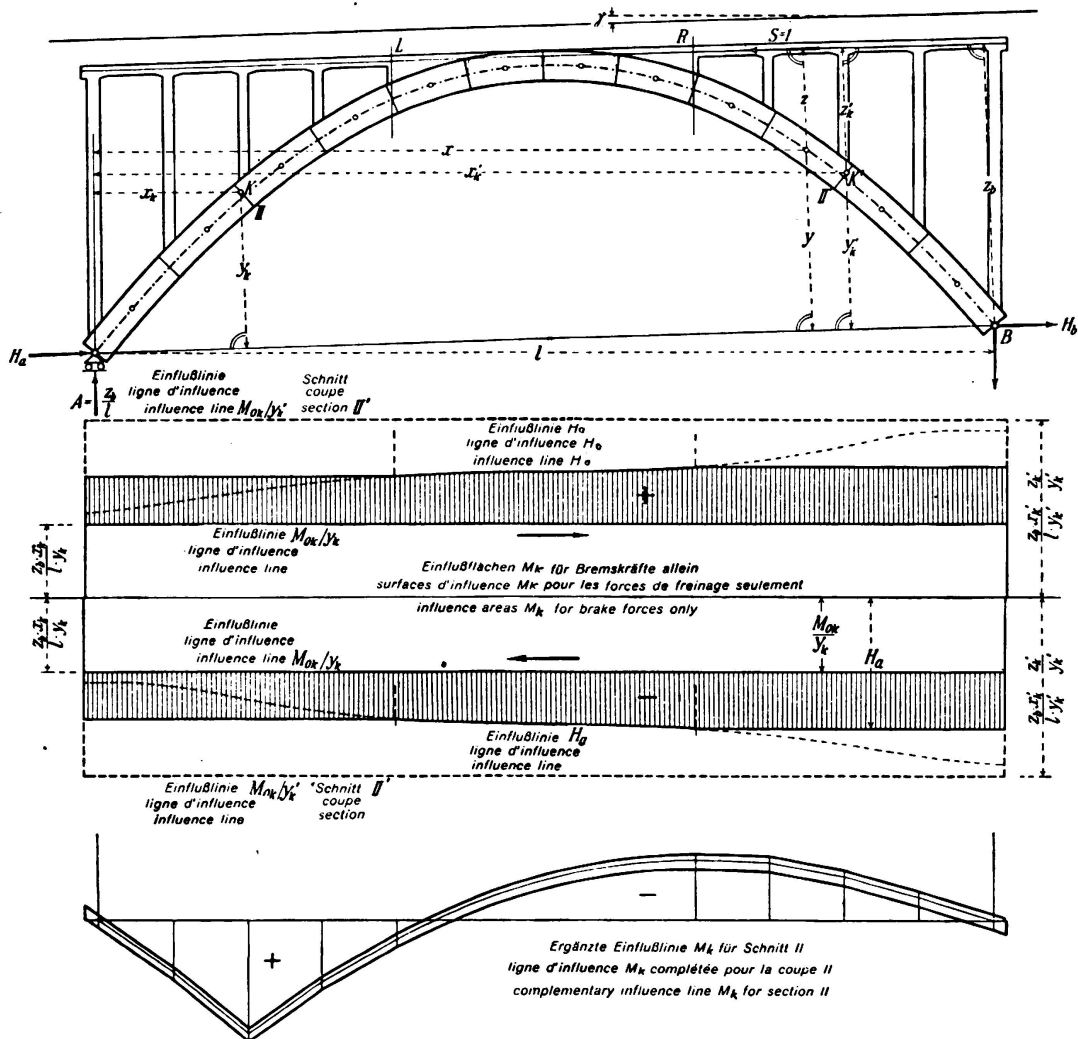

Fig. 14.

Influence lines H_a and M_k for braking forces for a two-hinged arch with open spandril.

This plane has to be maintained for the same reason when working out the influence line M_k for abutments and piers. In Fig. 14 an arch with oblique symmetry with open spandril construction is shown, where the decking is anchored to the arch at L and R. It is quite obvious and easy to realise that the integration of the nominator in the formula for H_a does not change the forces $S = 1$ if acting between L and R, and remains identical for this stretch as for arches with solid spandril construction. For any other position of S acting on the open spandril sections the integrations of the nominator are calculated as if the force S were acting in L or R. This is the reason for the influence line H_a having two horizontal sections from L to A and from R to B respectively.

The influence line M_{Ok} for braking forces only, assumes a similar shape for arch sections situated between L and R as in Fig. 13. But if the section containing the core point R has its position under the open spandril, between A and L, then for any position of the force $S = 1$ the moment $M_{Ok} = A \cdot x_k$. The influence area for these positions is therefore a rectangle with a height of $\frac{z_b}{l} \cdot x_k$. The same applies if the section of the arch is situated between R and B, only in this case the rectangle of the influence line has a height of $\frac{z_b}{l} \cdot x_k - z_k$.

The hatched area in Fig. 14 represents the influence line area M_k for section II for braking forces only, being the difference between two areas represented by

$$M_k = y_k \left(\frac{M_{Ok}}{y_k} - H_a \right)$$

For computation the factor y_k has to be considered.

Influence lines M_k for abutments and intermediate piers.

The force $S = 1$ acting to the left and placed in the middle plane of the decking, produces in the case of open spandril work, in a section for left abutment a core moment at K as expressed by:

$$M_k = A \cdot x_k - H_a \cdot y_k = \frac{z_b}{l} \cdot x_k - H_a \cdot y_k.$$

With this it is easier to calculate the ordinates for the influence line M_k as is done by forming the difference between two influence line areas, since the ordinates of the influence line for the abutment are $M_k = -z_k$; in other words equal to the normal distance from K to the plane passing through the centre of the decking. This plane, as previously mentioned, is also the plane of reference for influence lines for the abutments (Fig. 15).

For a section through the right abutment we receive

$$M'_k = B \cdot x'_k - H_b \cdot y'_k = \frac{z_a}{l} \cdot x'_k - H_b \cdot y'_k.$$

Based on these formulae are shown in Fig. 15 the calculated influence lines M_k and M'_k for braking forces only. The extreme ends left and right of these influence lines lie under those points of the central plane through the decking which are cut out by lines under the angle μ to the normal of the decking

passing through the outer edges of the respective sections of the abutments. The complemented influence lines are shown also.

The influence line M_k for a section through an intermediate pier is based on the information given by Fig. 15. The intermediate piers require only to be considered as taking alternatively the place of the abutments of the adjoining

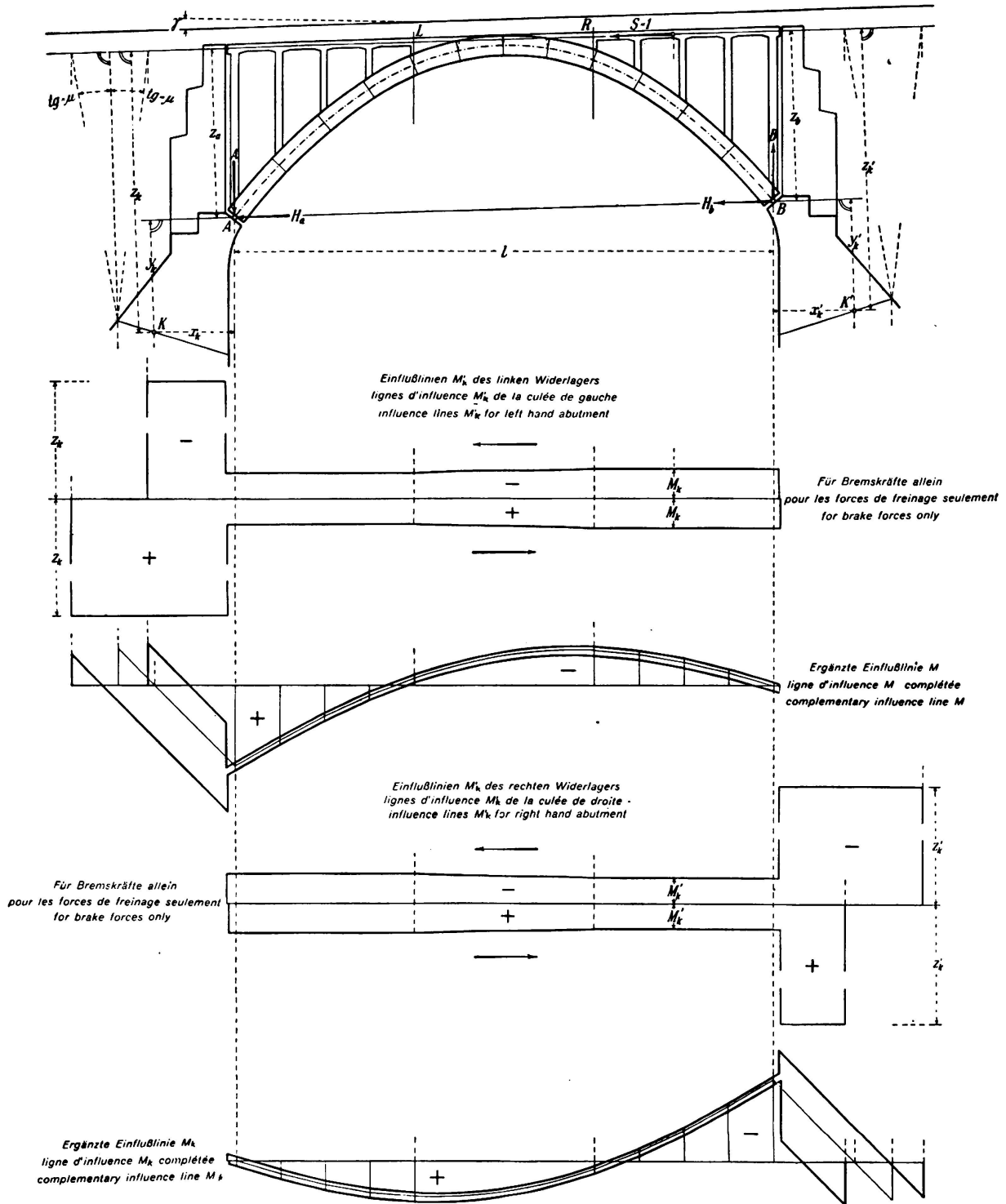

Fig. 15.

Influence lines M_k for braking forces, for sections through the abutments of a two-hinged arch.

spans. The condition is only (as already assumed above for the abutments) that the intermediate pier is comparatively low and of a squat nature, for which elastic deformations can be neglected.

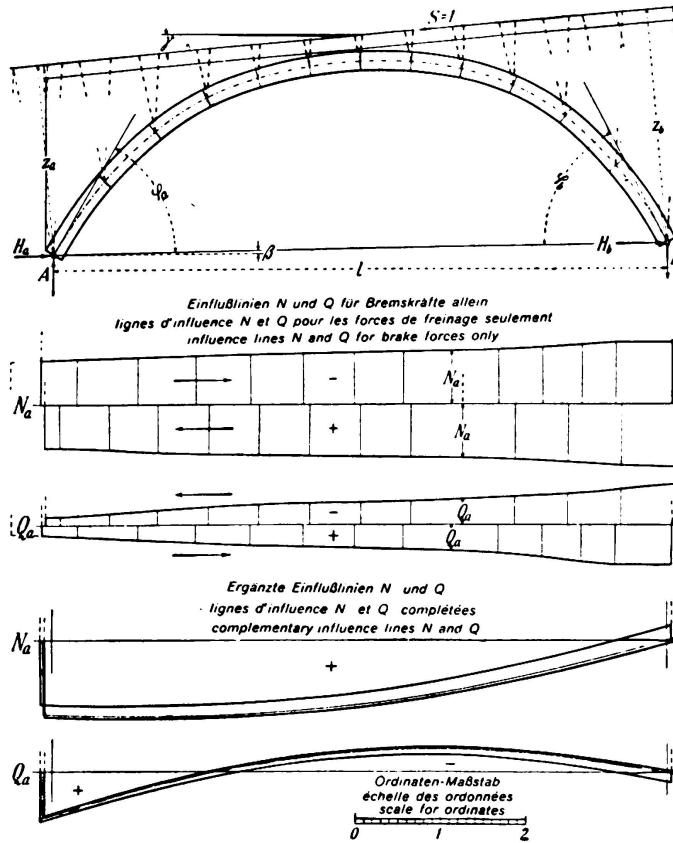

Fig. 16.

Influence lines for the normal and shear forces in the left hand hinged joint of a two-hinged arch, due to braking forces.

Influence lines for normal and shear forces for the hinge at the springing.

For a two-hinged arch as given by Fig. 16, the angles φ_a and φ_b are those which are formed by the reactions at the springing and the line connecting the springings. The plane tangent to the bearings at those places shall stand at right angles to the reactions.

The influence line for the normal force N_a acting on the left hinge due to a braking force $S = 1$ pointing to the left, is based on the following equation

$$N_a = A \cdot \sin(\varphi_a + \beta) + H_a \cdot \cos \varphi_a = \frac{z_b}{l} \cdot \sin(\varphi_a + \beta) + H_a \cdot \cos \varphi_a.$$

For the influence line for shear force the equation applies:

$$Q_a = A \cdot \cos(\varphi_a + \beta) - H_a \cdot \sin \varphi_a = \frac{z_b}{l} \cdot \cos(\varphi_a + \beta) - H_a \cdot \sin \varphi_a.$$

The influence lines in Fig. 16 for N_a and Q_a have been calculated on the basis of these formulae.

The braking forces for fixed arches.

For the same reasons as for the two-hinged arch the influence on deformations due to normal forces N_x can be dispensed with in the formulae for

reactions. The investigation is based on a basic system formed by an arched cantilever arm with the fixed end at the right hand side. To this statically determinate system apply the wellknown formulae (*Mörsch 2nd vol. part 3*)

$$H = \frac{\sum M_0 \cdot w_y}{\sum y \cdot w_y} \quad V = \frac{\sum M_0 \cdot w_x}{\sum x \cdot w_x} \quad M = \frac{-\sum M_0 \cdot w}{\sum w}$$

provided the components of the reactions at the free end of the cantilever have been moved into the elastic centre of the arch. The formulae are valid for any positions and directions of forces acting in the plane of the arch. A braking force acting at a and pointing to the left (Fig. 17) produces in the cantilever arch of the basic system bending moments $M_0 = -z$, in the region from a to B only. To establish the influence lines H , V , M , for braking forces it is only necessary to form for progressive values of a the summations:

$$\sum M_0 \cdot w_y = -\sum_a^{\frac{1}{2}} z \cdot w_y \quad \sum M_0 \cdot w_x = -\sum_a^{\frac{1}{2}} z \cdot w_x \quad -\sum M_0 \cdot w = \sum_a^{\frac{1}{2}} M_0 \cdot w$$

The easiest way to form these sums is by calculation, starting at the right end of the cantilever arm for the force $S = 1$ acting in turn above every section of two adjoining elements of the arch. For all these progressive positions the sum of the static moments of the elastic weights

$$w_y = s \cdot \frac{y}{J}, \quad w_x = s \cdot \frac{x}{J} \quad \text{and} \quad w = \frac{s}{J}$$

are formed to the right of the position of the force in respect to the decking, according to the type of superstructure above the arch proper. For every progressive step of the force S only one term has to be added to the previous sum. The elastic weights w , w_y and w_x and the sums of the denominator are already known from the preceding arch calculation. The ordinates of the influence lines have to be plotted under the abscissae a , i. e. below those points of the decking which are defined by the dividing line starting from the arch axis under the inclination $\frac{\mu}{\varphi}$ to the vertical. According to the sense of direction of the braking

forces not only the sign changes but the influence lines also receive a slight horizontal movement in respect to each other.

The influence lines established by calculation for the components H , V and M of the reaction at the springing, for a symmetrical fixed arch with horizontal decking, are given in Fig. 17. The left ordinate of the influence line H is equal $= 1$ and correspondingly for the influence line for M this ordinate has the value $= y_0 + z_s$. The analytical computation in tabulated form shows that a large number of figures are the same as those for the normal influence lines. The ordinates of the influence line for H are complementary to 1 for sections placed symmetrically.

By means of the ordinates of the influence lines for H , V and M the influence lines for core moments for any section of the arch due to braking forces can be produced by using the formula:

$$M_k = M_{Ok} + M - H \cdot y_k - V \cdot x_k$$

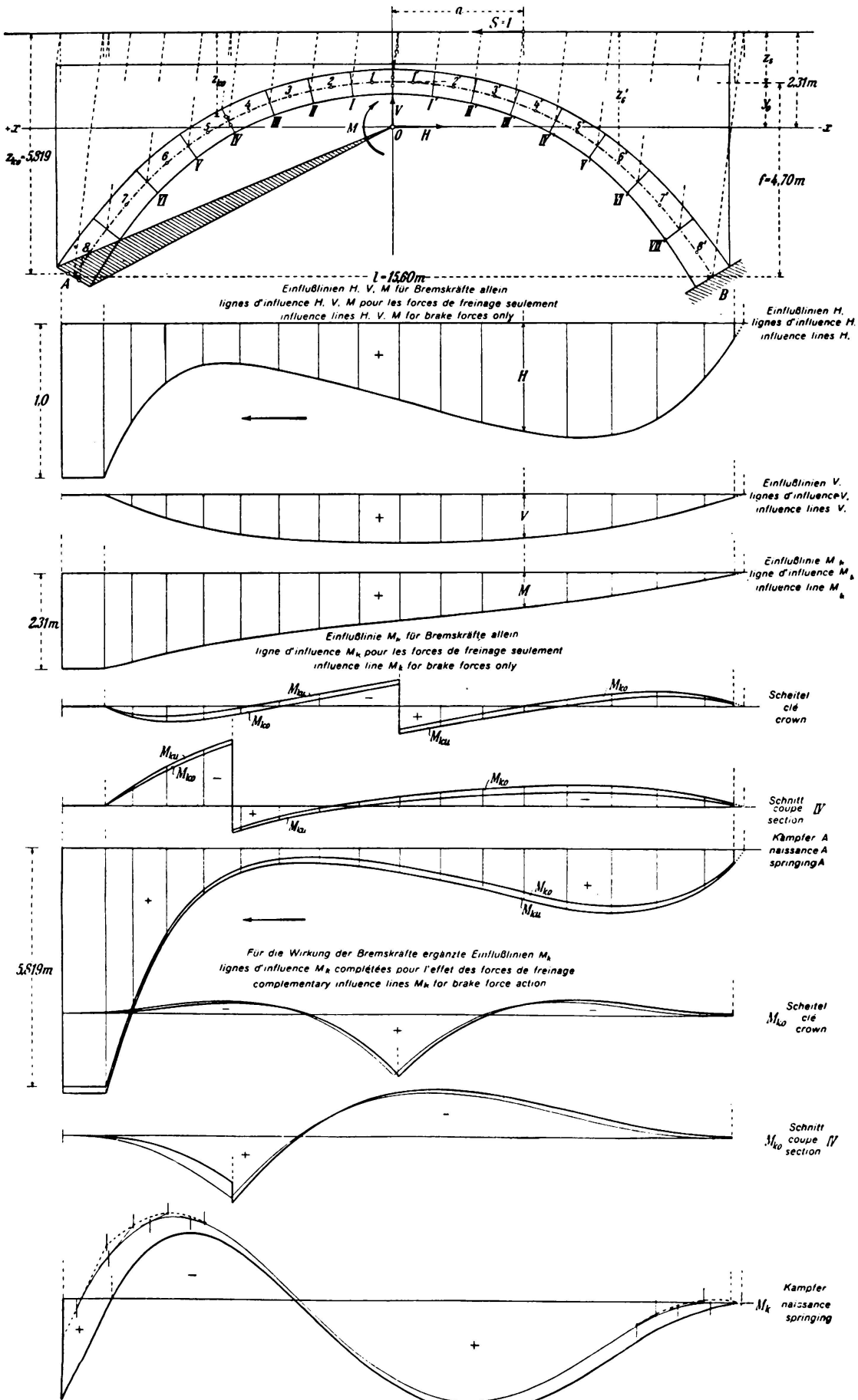

Fig. 17.

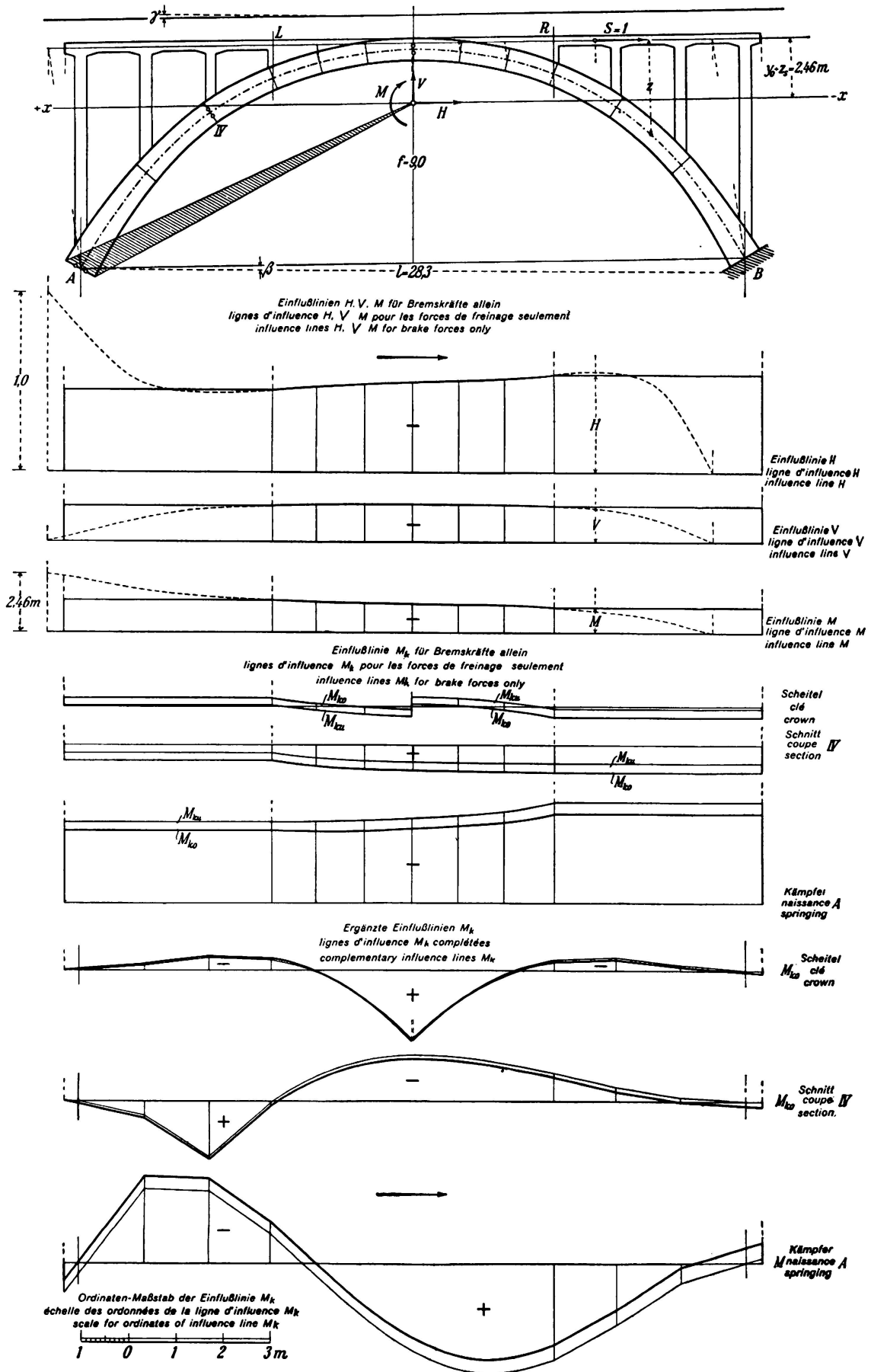

Fig. 18.

To achieve this it is best to start at the right end, applying the force $S = 1$ in turn at every division point, and to tabulate the results in the same way as for normal influence lines: $M_{Ok} = -z_k$ for a force S pointing left if acting left of the arch-section containing the point K , but if acting right of this section then $M_{Ok} = 0$. In this manner the influence lines M_k seen in Fig. 17 for braking forces only, for the crown, springing and section IV were established. Further are shown the final influence lines for these sections containing the effects of braking forces. The scale for the ordinates of influence lines shown in light lines is double the scale of the drawing for the arch. The bold lines are for complemented influence lines containing $\frac{\mu}{\varphi}$ times the values of the ordinates of the influence lines M_k for braking forces only.

It was also necessary to correct the ends of the normal influence line for the springing, for the vertical component of axle load belonging to S comes to stand much outside the respective division line with the arch axis, the tangents to the division points at the curve had therefore to be produced up to the position of the corresponding loads P . The curve shown in dotted line represents the correction to the normal influence line M_k . The corrections at other places to the normal influence line are so minute that it is better to ignore them altogether.

It may also be mentioned that the usual basic system of cantilever arm fixed at the left end also proves very useful in calculating with braking forces.

The equations for the components H , V and M of the arch reaction for braking forces $S = 1$ remain unaltered, even for unsymmetrical arches and arches with oblique symmetry. The x -axis is inclined in such cases, and the ordinates z are represented to be the normal distance of the arch elements from the decking.

The arch shown in Fig. 18 has an open spandril construction as the arch of Fig. 14. The inclined braked axle loads require also in this case to be applied in the middle plane of the decking where they are divided into the components P and S . The forces S are transmitted to the arch only at L and R . On account of this, the ordinates of the influence lines for H , V and M under the open spandrils remain constant, equal to the ordinates of point L and R respectively. The flow of the influence lines between L and R is similar to that of the influence lines for solid spandril construction, only that in this case the reference plane for the forces S lies at a lower level.

The influence lines have been given for braking forces pointing to the right.

The influence lines shown dotted are those which would apply where the spandril construction is solid.

Influence lines M_k for the abutments of fixed arches.

Using the denominations given in Fig. 19 the core moments in a section through the left abutment for braking forces $S = 1$ are expressed by:

$$M_k = M + H \cdot y_k - V_k,$$

wherein the sign of the components has been considered.

For a section through the right hand abutment we receive:

$$M'_k = z'_k - M - H \cdot y'_k - V \cdot x'_k.$$

It was on these two formulae that the ordinates of the influence lines for braking forces for the respective section through the abutments were calculated. The ordinates of the influence lines below the abutments are z_k and z'_k respecti-

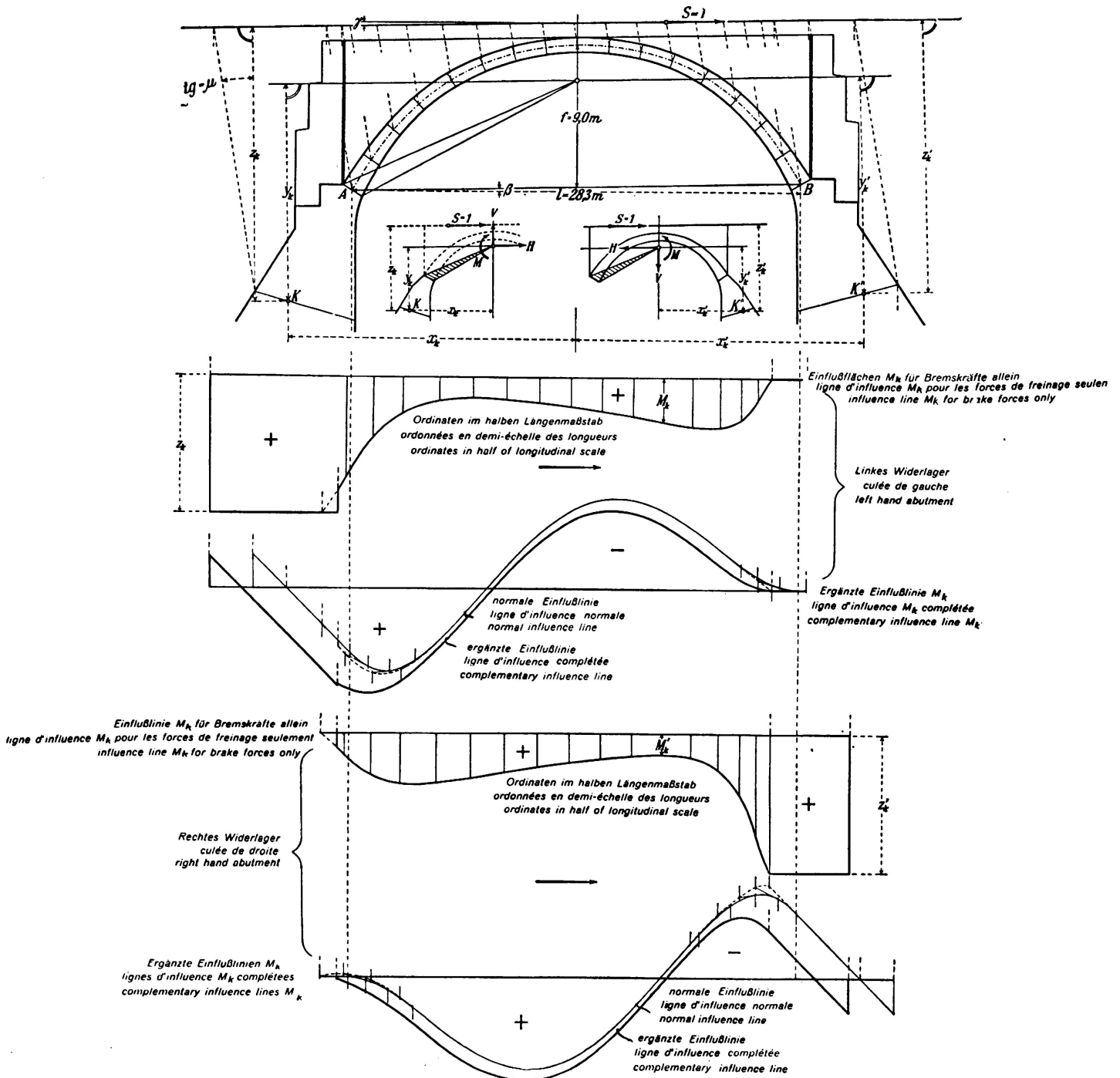

Fig. 19.

Influence lines M_k due to braking forces for sections through the abutments of an fixed arch of oblique symmetry.

vely. By adding μ -times the value of the ordinates for braking forces only to the ordinates of the ordinary influence lines we receive the final influence lines. It is however necessary, as in the case of Fig. 17, to correct the ordinary influence lines for the portions under the abutments on account of the massive construction, previous to adding the values of the ordinates for braking forces only.

In a similar manner the influence lines for sections through an intermediate pier are received by considering the intermediate pier as taking in turn the position of end abutments for each adjoining span. It is only necessary for the pier to be of a stout nature, such that elastic deformations can be neglected.

Summary.

A study is made of the influences of braking forces on various types of beams and arches. The braking force is considered to be a part of the axle load. The effects of braking forces on moments, core-moments, reactions, are given in the form of influence lines; finally these influences are combined with those resulting from the effects of vertical axle loads, thus supplying by computation with the normal (standard) train of loads the ultimate values, including those resulting from the action of braking forces. The shape of the influence line for braking forces only varies with the type of spandril construction over the arch proper; it is different for solid and open spandril work.

Leere Seite
Blank page
Page vide