

Reinforcement of pressure pipes for the Marèges hydro-electric plant

Autor(en): **Mary, M.**

Objektyp: **Article**

Zeitschrift: **IABSE congress report = Rapport du congrès AIPC = IVBH
Kongressbericht**

Band (Jahr): **2 (1936)**

PDF erstellt am: **21.07.2024**

Persistenter Link: <https://doi.org/10.5169/seals-3219>

Nutzungsbedingungen

Die ETH-Bibliothek ist Anbieterin der digitalisierten Zeitschriften. Sie besitzt keine Urheberrechte an den Inhalten der Zeitschriften. Die Rechte liegen in der Regel bei den Herausgebern. Die auf der Plattform e-periodica veröffentlichten Dokumente stehen für nicht-kommerzielle Zwecke in Lehre und Forschung sowie für die private Nutzung frei zur Verfügung. Einzelne Dateien oder Ausdrucke aus diesem Angebot können zusammen mit diesen Nutzungsbedingungen und den korrekten Herkunftsbezeichnungen weitergegeben werden. Das Veröffentlichen von Bildern in Print- und Online-Publikationen ist nur mit vorheriger Genehmigung der Rechteinhaber erlaubt. Die systematische Speicherung von Teilen des elektronischen Angebots auf anderen Servern bedarf ebenfalls des schriftlichen Einverständnisses der Rechteinhaber.

Haftungsausschluss

Alle Angaben erfolgen ohne Gewähr für Vollständigkeit oder Richtigkeit. Es wird keine Haftung übernommen für Schäden durch die Verwendung von Informationen aus diesem Online-Angebot oder durch das Fehlen von Informationen. Dies gilt auch für Inhalte Dritter, die über dieses Angebot zugänglich sind.

VI 6

Reinforcement of Pressure Pipes for the Marèges Hydro-Electric Plant.

Umschnürung der Druckleitungen des Kraftwerkes in Marèges.

Le frettage des conduites forcées de l'usine hydro-électrique de Marèges.

M. Mary,

Ingénieur des Ponts et Chaussées, Paris.

On October 5th, 1935 the Minister of Public Works inaugurated the dam and hydro-electric plant at Marèges which have been built in connection with the electrification of the Paris-Orleans railway, under the charge of the Special Conservancy Service of Haute-Dordogne directed by Mr. Coyne, Ingénieur en Chef des Ponts et Chaussées.

This undertaking has been the subject of many articles in the technical press,¹ and its essential features will here briefly be recapitulated:

An arch dam 90 m high with a crest development of 247 m has been built across the Dordogne, 18 km below Bort-les-Orgues, forming an artificial lake of 230 hectares which contains 47 million m³ of water, whereof 35 million m³ can be utilised. Some 250 m below the dam the hydro-electric station has been built in an opening of the valley due to secondary streams; this contains four vertical sets of 34,000 KW each and two auxiliary sets of 2,300 KW.

The object of this paper is to describe in detail an entirely new method of construction which has been applied to part of the pressure pipe lines.

I. Statement of the problem.

The water is conveyed from the dam to the plant through underground tunnels. Intakes are arranged with their sills 35 m below the normal storage level, and two tunnels of 6.2 m internal diameter and 135 m length, on a slight gradient, lead from these. Each tunnel forks, at its lower end, into two pressure pipe lines, also underground; these are of 4.40 m internal diameter and of lengths varying between 120 and 150 m. These buried pipe lines terminate inside the station where they are connected to the turbines through sections of metal pipe 20 m long. The general arrangement of the plant is shown in Fig. 1 and 2.

The inflow tunnels carry a maximum internal pressure head equal to 45 m of water. They pass through a compacted mass of rock and it has not been considered necessary to reinforce the lining, which has an average total thickness

¹ See in particular *Le Génie Civil* of 7th July, 1934 and 26th October, 1935.

of 0.35 m of solid concrete produced by the cement gun (Fig. 3). The bond between the concrete and the rock, and the filling of fissures, has been made good by injection. From below the foot of the surge chambers the pressure becomes greater on account of the gradient of the tunnels and of the hammer blow due to sudden closure of the turbines: at the lower end it may amount to a head of 102.5 m, of which 72.5 m represents the static head and 30 m the effect of the hammer blow. Here, moreover, the rock is not so good, and

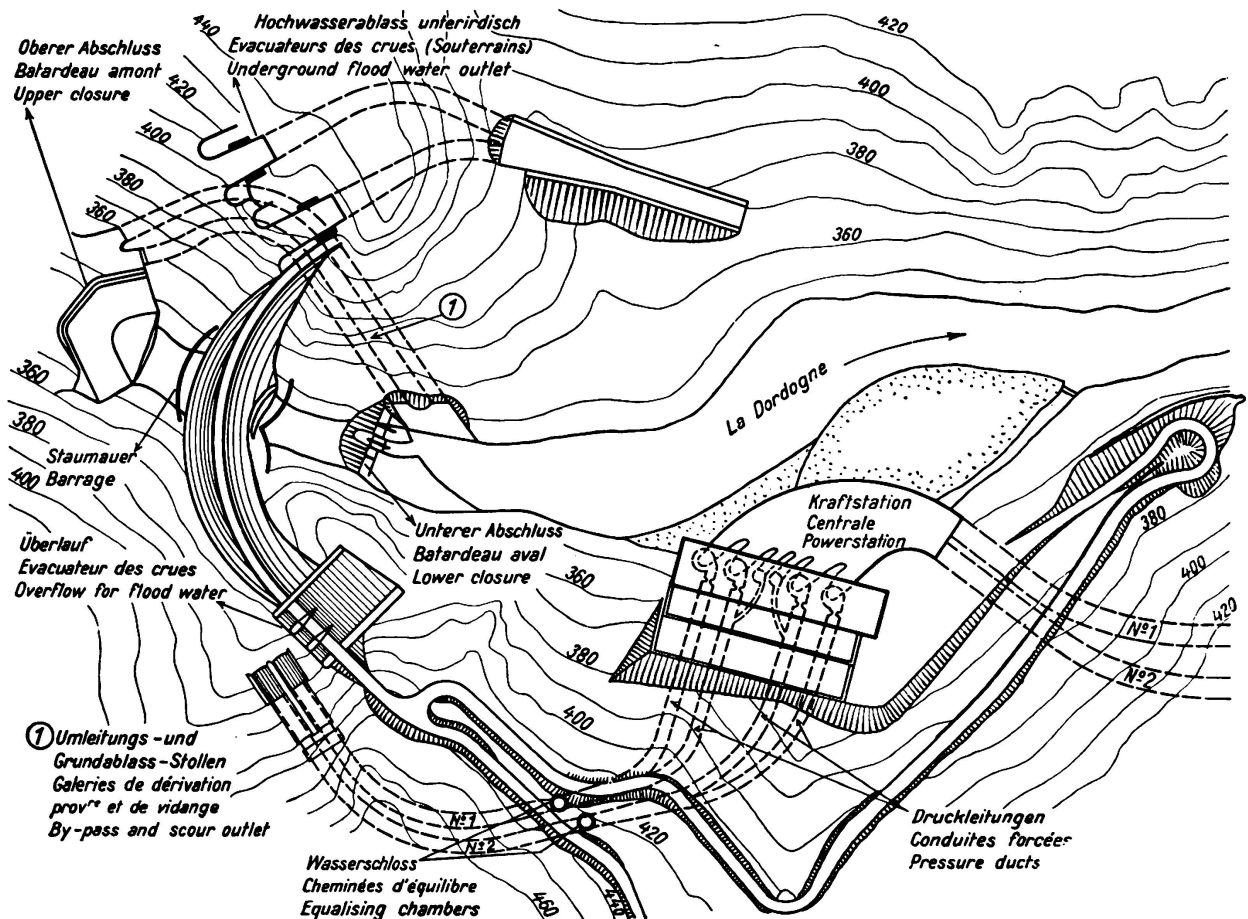

Fig. 1.

Barrage. Situation.

the lining has in consequence been strongly reinforced, consisting of 0.35 m thickness of ordinary block concrete in addition to reinforced gunite (Fig. 4).

As the thickness of rock cover was considered great enough to allow of it being taken into account for the purpose of strength, the cross section of the steel hoops forming the reinforcement of the gunite has been so calculated that if the steel be assumed to take the whole of the internal pressure the stress in it will approximate to the elastic limit. Actually the stress is much lower on account of the increased strength of the structure due to the concrete lining and the rock cover, and while it is difficult to calculate the proportion of this relief it is certain that the stress in the steel could in no circumstances exceed the elastic limit. Here again perfect bonding of the concrete to the rock has been made certain by careful injection. Acoustic detectors, on the system in-

vented by Mr. Coyne, have been installed at several points to allow the stress in the reinforcements to be checked during operation. On January 15th, 1936, this stress was about 2.5 kg/mm² and the pressure was such that if the whole of its effect had to be resisted by the steel alone the stress therein would have amounted to 10 kg/mm².

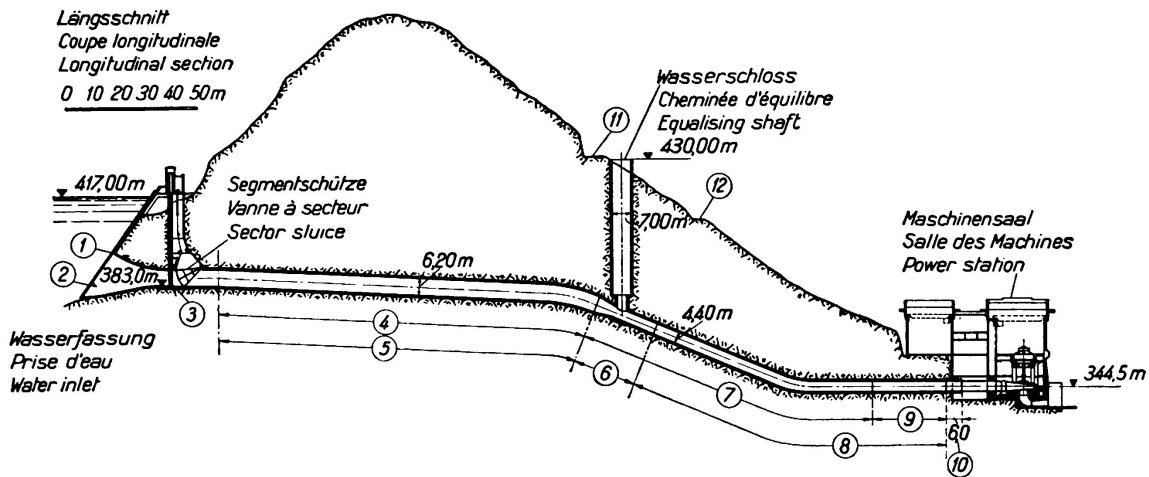

Fig. 2a.

Hydro-Electric plant of Marèges Water inlet and pressure duct N° 1.

- | | | |
|-----------------------------------|--------------------------------|----------------------------------|
| 1) Rake rails for cleaning grate. | 5) Main duct. | 9) Laterally reinforced portion. |
| 2) Grate. | 6) Branching of ducts 1 and 2. | 10) Anchorage of metal duct. |
| 3) Emergency sluice. | 7) Reinforced gunite lining. | 11) Road to barrage. |
| 4) Gunite lining. | 8) Duct N° 1. | 12) Road to power station. |

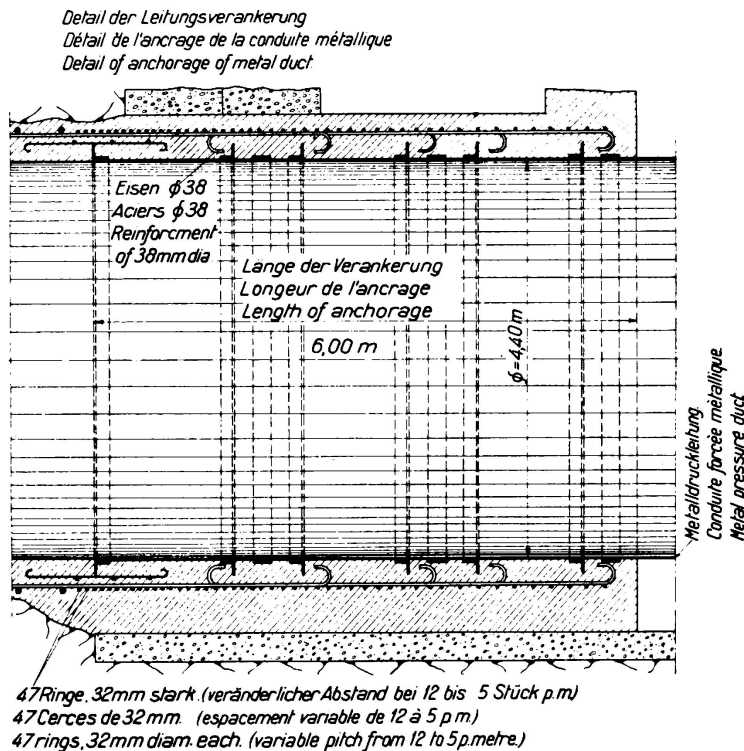

Fig. 2b.

Detail of anchorage of metal duct.

In the last 30 m run of the underground tunnels before discharging into the steel pipes they pass through rock of poor quality and the thickness of cover falls to 10 m. It is in this zone that the water pressure is at its greatest and may reach 102.5 m head including the hammer blow; the form of construction adopted over the remainder of the run did not, therefore, appear to afford a sufficient margin of safety here, and if for safety the resistance of the rock cover is left out of account the problem reduces itself to that of designing the pipe to give strength characteristics similar to those necessary in the open.

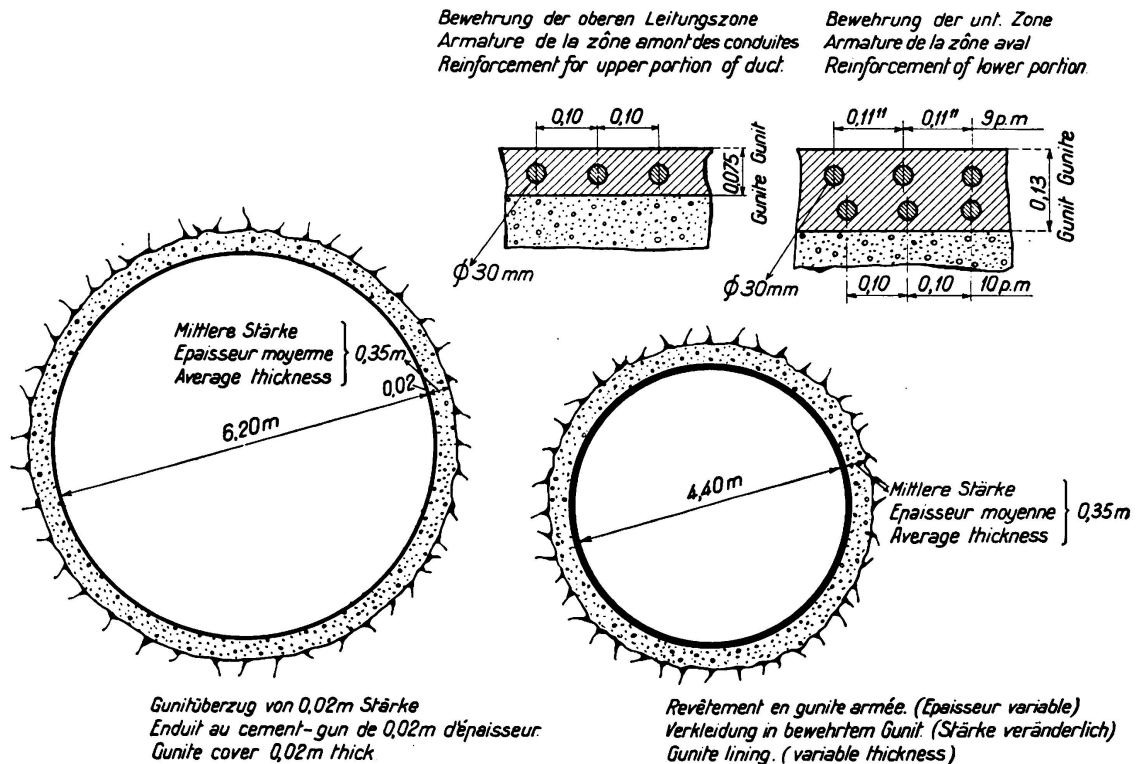

Fig. 3 and 4.

Cross section of water duct.

Cross section of pressure duct and details of reinforcement.

To our knowledge, however, no examples exist of reinforced concrete pipes even remotely approaching the diameter and pressure that occur here. The present state of knowledge on reinforced concrete pipes is such that engineers deem it advisable to observe the following two fundamental rules:

- 1) The reinforcement must be given a cross section large enough to withstand the whole of the pressure, and
- 2) The concrete must be given a thickness such that, taking into account the presence of the reinforcement, its limit of resistance to extension will not be exceeded.

The latter rule is of essential importance because a pipe becomes practically useless if cracked.

To apply both these rules in the present case would have meant providing 200 cm² of steel per metre run of the pipe and making the pipe wall at least

1 m thick. But in a lining of that thickness would the fundamental rules governing the resistance of reinforced concrete to direct tension still hold good? It seems unlikely. Despite the magnitude and cost of the work carried out in that form there could be no certainty that its permanence would not be imperilled by serious cracking or might not necessitate onerous measures of consolidation soon after the plant had been brought into operation.

If the idea of a reinforced concrete pipe were to be abandoned the only solution on accepted lines would be to extend the steel pipe for some 30 m length inside the tunnel, and this might be done in two ways. The first alternative would have been to arrange the pipe freely within a tunnel large enough to allow access to its outside surface — but the amount of excavation involved would have been enormous and it would have been necessary to provide a lining against falls of rock. The second alternative would have been the more usual one of filling the space between the pipe and the rock with concrete, an awkward and costly proceeding. Whichever method had been adopted the cost of the work would have attained large figures.

Economic considerations led to another solution namely the construction of a pipe formed of ordinary concrete hooped with steel cables.

II. Preliminary investigations. Experiments and tests.

One of the greatest of the difficulties needing solution was that of how to form the hooping underground. As soon as the scheme was considered it was realised that the hooping would necessarily have to be made as follows (Fig. 5): when the full section of the tunnel had been excavated the cables would be placed in circular tubes against the rock wall; then the pipe would be formed by concreting up to the rock, burying the tubes in the concrete; after a few days for the latter to harden, the cable would be tensioned and secured, the tube would be filled with cement grout to preserve the metal, and an injection would be made between the concrete and the rock so as to increase the factor of safety by making the rock participate in the strength of the structure.

The main difficulty was to decide how to attach the cables for the purpose of putting them in tension. The first scheme (Fig. 6) was to have a side tunnel giving access to one end of the cable while the other was embedded in the concrete: but with this arrangement the tension in the cable would fall off progressively from the end actuated by the jacks to the other end, by reason of the friction between the cable and the sheath.

Experiments were then made to determine the coefficient of friction between cable and steel plate, and to try to find substances which would reduce the coefficient as much as possible. No such material was found which would reduce the coefficient of friction below 0.10—0.15, and assuming the value was 0.15 the tension at the sealed end of the cable would amount only to the

fraction $\frac{1}{e^2 \pi \cdot 0.15} = 0.385$ or about one-third of the tension imposed by the jacks at the other end. Such unevenness of tension would not have the effect of producing a flexure liable to crack the pipe: the pressure curve would still remain very well centred and would deviate from the mean fibre only by very small amounts: nevertheless it is true to say that very poor use would thus be made

of the cable. To improve the arrangement it would be necessary at least to leave both ends of the cable free so that both could be jacked and the length of the surface under friction reduced to a semi-circumference, and if this were

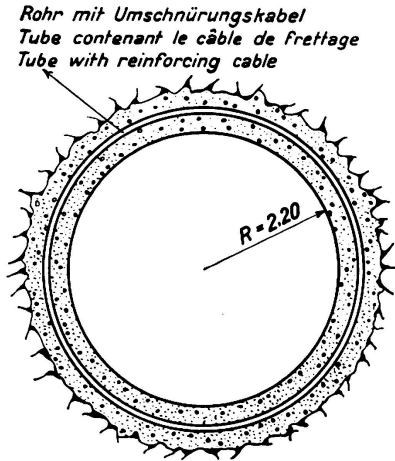

Fig. 5.

Diagrammatical section of duct with lateral reinforcement.

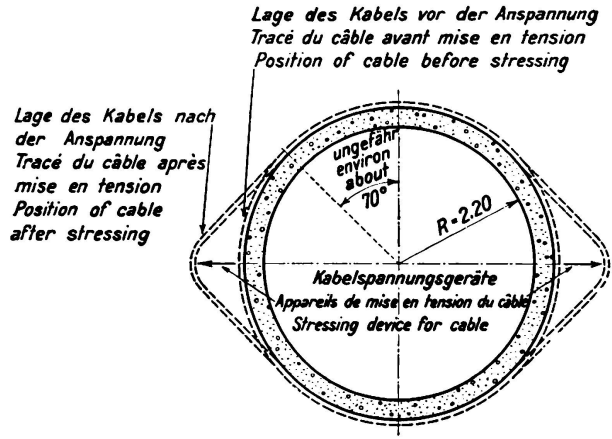

Fig. 7.

Diagram of second proposal for lateral reinforcement.

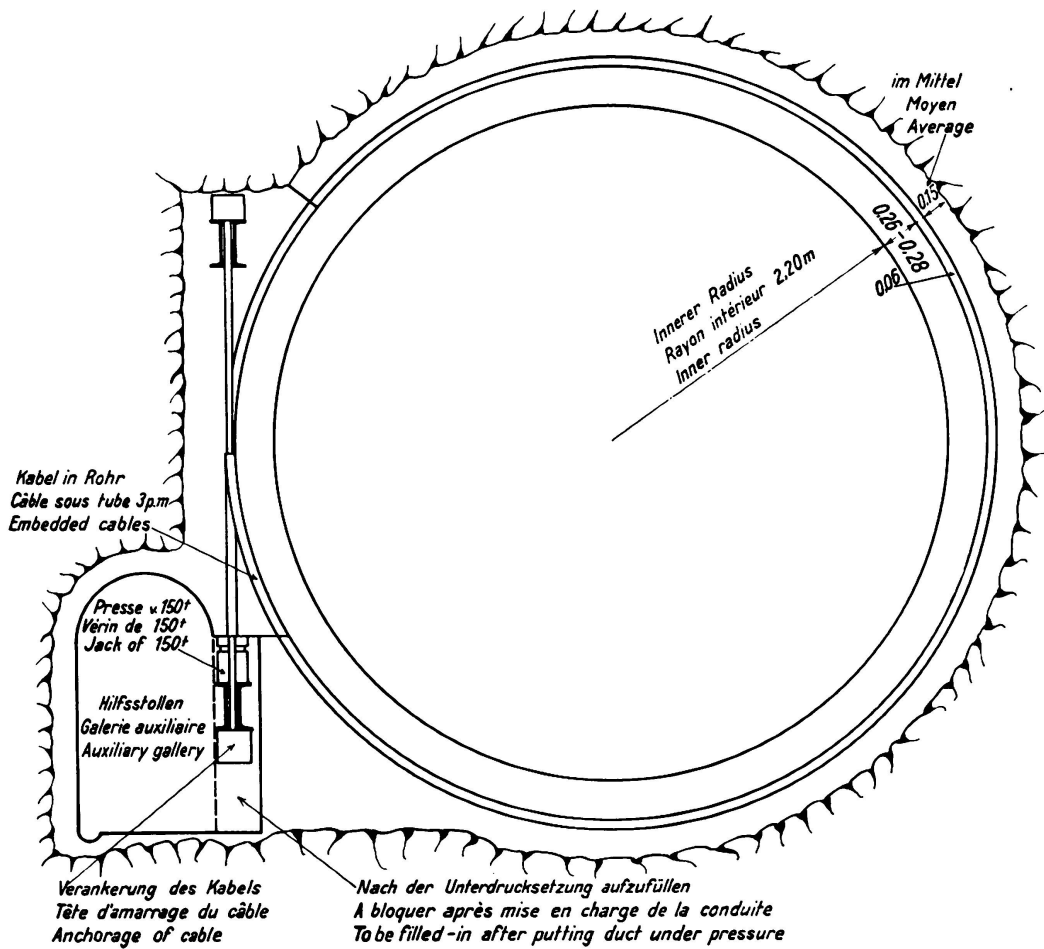

Fig. 6.

Proposed method of reinforcing underground duct by stressed steel cables.

done the ratio between the greatest and least tension in the cable would amount to $\frac{1}{e\pi \cdot 0.15} = 0.62$, corresponding to a loss of 38%.

It should be possible to go further in this direction by making use of graphites to lubricate the cable, but this research was not followed up as it was supplanted an especially interesting suggestion made to us at that juncture by Mr. Guerrier, engineer to the firm of Léon Ballot. This proposal has enabled us to carry out the hooping operation in a very practical way whereby the coefficient of friction becomes a matter of entirely secondary importance.

Mr. Guerrier's idea was to tension the cable by deforming its shape as shown in Fig. 7. This device enables the jacks to be placed inside the pipe itself, so avoiding the need for the auxiliary tunnel. The effect of the friction of the cable on the sheath is reduced to a part of the circumference subtending an angle of about 70° at the centre. The simplest arrangement, *a priori*, would appear to be that of making the two jacks press one against the other (Fig. 8),

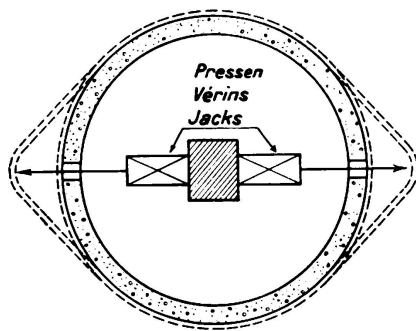

Fig. 8.
Scheme.

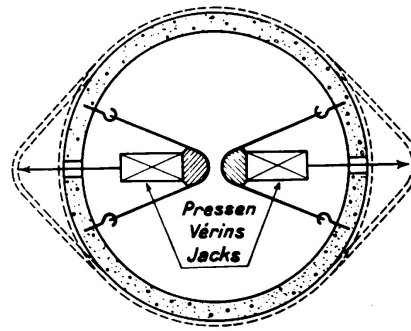

Fig. 9.
Adopted scheme.

but as the cable would be bearing on only a portion of the circumference there would be a tendency to ovalisation and the line of pressure would deviate considerably from the mean fibre. To re-establish a state of elastic equilibrium with the pressure curve close to the mean fibre it might be suggested that tie bars should be added, and the stress in them carefully adjusted at each moment of the operation; this, however, would be a very delicate matter, and it did not appear a practicable solution. It was deemed preferable to adopt the arrangement in which the two jacks are left independent of one another, each bearing upon the pipe itself through the medium of cables sealed in as shown in Fig. 9.

Once this essential point had been decided the hooping scheme took definite shape as indicated in Fig. 10. The protecting tube for the cable is enlaid at each end of the horizontal diameter, in the shape of a flat box which enables the cable to be deformed as requisite for tensioning. At the bottom the two ends of the cable are provided with cast steel anchoring shoes, embedded in the concrete and pressing against one another through the intervening concrete. Where the cable passes through the side boxes it is exposed through openings provided for the purpose, and the jacks operate on the cable through the medium of pieces of cast steel called mushrooms, which are enclosed in the boxes and serve to give the deformed part of the cable a large enough radius

to avoid breaking the strands by bending. The jacks bear against the pipe through anchoring irons enclosing the boxes. All these arrangements will be described in greater detail later.

The proposal as thus conceived had some rather bold features which made it inexpedient to put the scheme into full effect until qualms had been allayed by preliminary experiments.

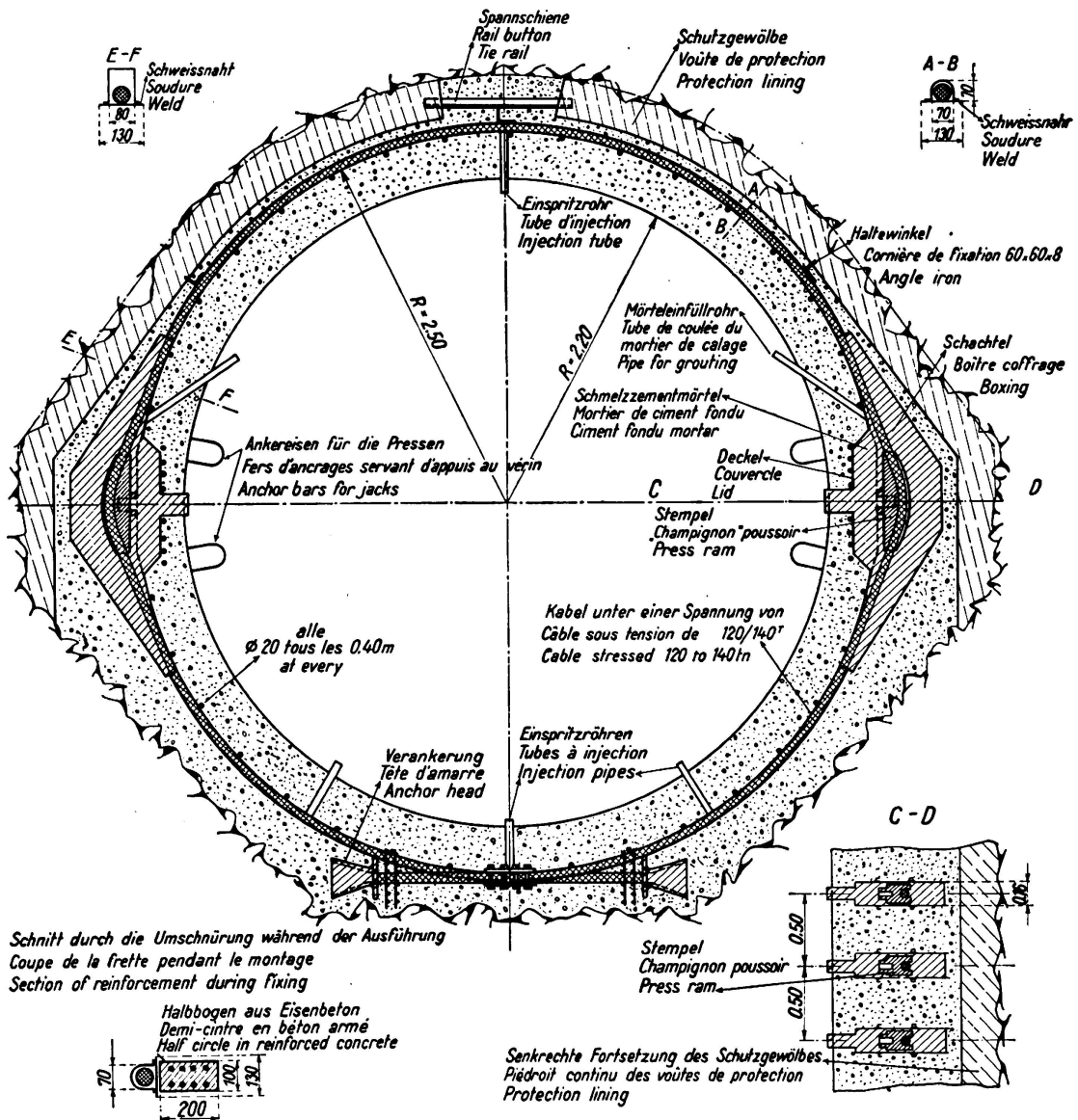

Fig. 10.

Pressure ducts. Laterally reinforced partion. Section showing lateral reinforcement.

In the first place, the amount and bulk of material that had to be gathered around each cable made it necessary to reduce the number of cables per metre run of piping to a minimum. Various considerations contributed to the decision to fix this number at two, each cable then having to receive a tension of at least 110 metric tons. What would be the behaviour of a concrete pipe subjected to localised loads of this magnitude? Nothing but experience could answer this.

Secondly, theory indicated that the curve of pressure would remain very close to the mean fibre in spite of the localisation of forces resulting from the cable being actuated by the jacks at only two points in the circumference: but the fact called for experimental verification.

Finally, experiment alone could determine what would happen to the concrete under the enormous local pressure brought to bear by the cable, and to what extent the cable would be impressed into the concrete.

It was decided, therefore, to carry out a full scale experiment on a vertical cylinder of 4.40 m diameter, 25 cm thick, very lightly reinforced. The essential conclusions reached in this way were the following:

1) Only one crack was observed; this happened when the tension in the cable amounted to 125 metric tons and it took the form of a complete circle on the

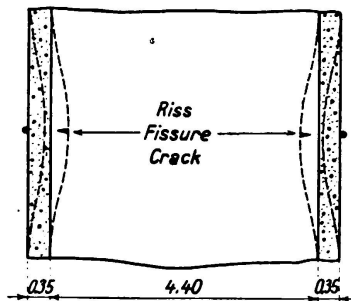

Fig. 11.

Longitudinal deformation of tube
with local lateral binding.

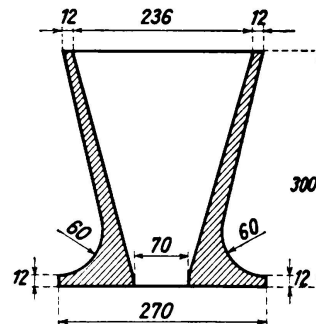

Fig. 12.

Section through anchor shoe.

inside surface of the pipe within the cable. It was caused by longitudinal bending of the walls (Fig. 11), and the inference was drawn that if, under the conditions of the experiment, the tension of the cables is to be carried beyond 125 tonnes, care must be taken not to impose this load in a single cable alone but to do so in several adjacent cables at the same time. It will at once be clear that if a cable has been stressed up to, say, 120 metric tons without cracking, the tensile forces which tend to produce cracking will be greatly lessened as the neighbouring cables are tensioned, so that when the hooping of the whole length of pipe has been completed there will no longer remain any danger of cracking subsequently taking place. It may be added that actually such cracking due to bending is of no importance as regards the quality of the pipe; nevertheless its occurrence has been avoided.

2) The tension in the cable was increased up to 156 metric tons without any other crack appearing. It is noteworthy that there was no longitudinal crack, such as could not fail to have arisen if the curve of pressure had come outside the middle third of the section.

3) The measuring instruments fitted on the surface (the acoustic controls of Mr. Coyne) showed that in a longitudinal direction the stress in the concrete was distributed over a length of about 1 m to each side of the cable, even though the thickness of the wall was only 0.25 m. This result served to allay any possible apprehension regarding the actual scheme, in which the cables were

to be spaced 0.50 m apart in a minimum thickness of wall of 0.40 m, by making it clear that in spite of the hooping being concentrated in a small number of cables under heavy tension the compression in the concrete would be practically uniform.

4) Finally, it could be ascertained that the cable and its sheath left no perceptible impression on the surface of the concrete.

The experiments having been entirely successful it was decided to proceed with the application of the scheme over a length of 28.5 m at the bottom end of each of the pressure conduits, making 114 m in all.

Other experiments were also carried out in order to determine certain details of the design. Among the first of the problems arising was that of finding an economical means of fixing the ends of the cable. One *a priori* possibility was simply to embed the two ends in the concrete of the pipe itself, relying on adhesion to give the necessary anchorage. It would be necessary for this purpose to completely unstand a certain length of each end of the cable, for it is not possible to rely on the adhesion of a cable or a stand, the effect of tension being to reduce the diameter by a perceptible amount. So many interlacing wires would, however, have made concreting difficult, and it was deemed preferable to terminate the cable by means of ferrules such as are used in the construction of suspension bridges. It was found by trial that cast steel ferrules of 30 kg weight (Fig. 12) were amply sufficient to carry a tensile force of over 220 metric tons no case of breakage of a ferrule occurred, nor was there any case of breakdown in the adhesion of the wires. The cable always broke on reaching its normal breaking load; moreover it scarcely ever broke at the opening of the ferrule although one might expect it to be slightly weakened there by the curvature of the wires. It may be added that instead of the filling being made with molten metal as is usual in suspension bridges, this was done with cement mortar and the result is entirely satisfactory. Ferrules were also successfully made entirely of reinforced concrete, but the steel type was finally preferred.

Another important problem was that of securing the cables, when tensioned, by the interposition of packing between the steel "mushroom" and the cover of the flat box so as to allow the jacks to be released. It was impossible to insert a previously fashioned body into this space, and there was no alternative but to pour into it some material that would set and would be able after a short time to withstand a compression of over 100 kg/cm². After some unsuccessful experiments in packing with dry sand the choice finally fell on the use of mortar made with ciment fondu, which gave every satisfaction: the jacks could be removed, without danger, six or seven hours after casting, and the cement having been cast in a completely closed box, bound by some means in all directions, underwent only an infinitesimal amount of settlement at the moment the jacks were removed — less than a millimetre, whereas the extension of the cable itself through tensioning is about 13 cm.

Further tests were made on the cables to determine their elastic elongation and permanent set, particularly for the purpose of calculating what depth should be given to the flat boxes. These tests showed that it was possible to rely on the strain being nearly elastic, with a coefficient of elasticity equal to about half that of the steel.

Finally, mention should be made of the measurements of loss of tension in the cable due to ageing; these showed that such losses could not be considerable, and the only action taken in consequence was to increase the initial tension to 135 tons instead of the 110 tons strictly necessary.

III. Detailed description of the arrangement.

In this chapter it is proposed to review all the details of the scheme, giving briefly the reasons which led to their choice:

1) *Cables.* — As stated in the last paragraph of the preceding chapter, the cables were tensioned to 135 tonnes. This led to the adoption of cables having a breaking strength of 220 metric tons. The working stress, being close to the elastic limit, may appear high by comparison with the stresses that are usual in constructional work. Actually when the cable is tensioned the stress is adjusted to a figure which is accurately known; the experiment on the hooping of a vertical cylinder had shown that the cable did not, at any point, undergo such flexure as might reduce its breaking strength, so that no fear need be entertained

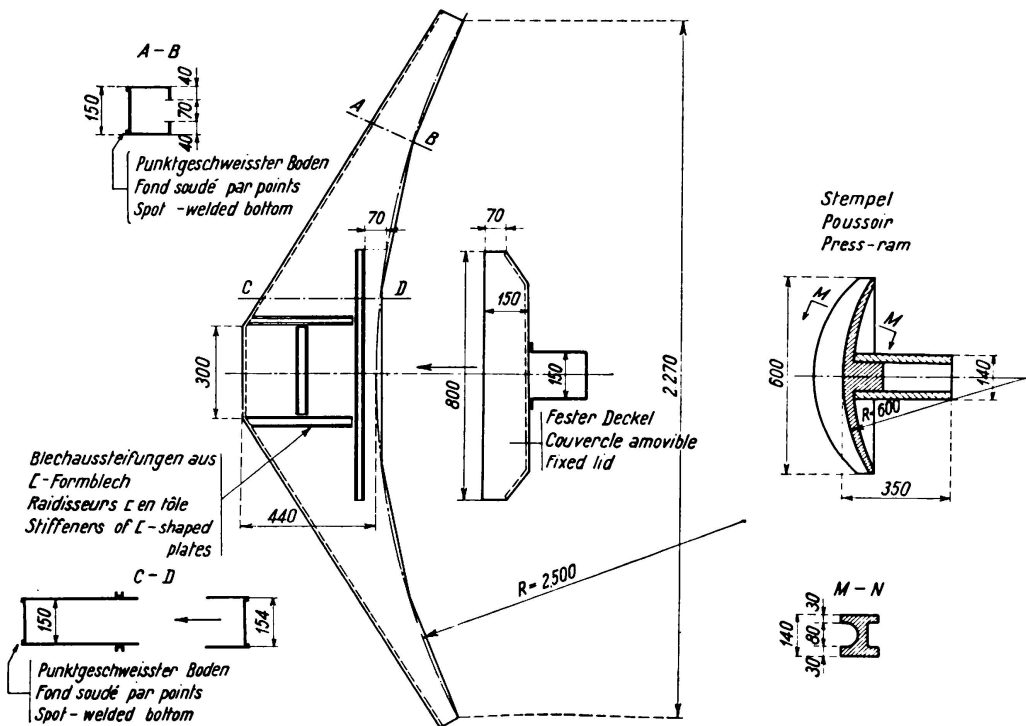

Fig. 13.

Pressure ducts. Steel box for placing and fixing of lateral reinforcement.

of the real stress exceeding that calculated and there is no point in preserving an exaggerated margin of safety in the operation. Moreover, in the moment immediately following the tensioning and packing of the cable there is bound to be a tendency for the tension to diminish. Once the packing has been done, the compressed ring of concrete and the cable act together as one; under the action of the internal water pressure they undergo equal amounts of elongation — but these amounts are very small; the static pressure produces an additional

tension in the cable which may be put at 3 tons, and the hammer blow a further one ton which develops progressively during the period of closure of the valves, about 4 seconds. These extra tensions, which are added to the initial tension of 135 tons, are the only forces in the problem imperfectly known, and in respect of these there is a very high factor of safety. The cables consist of six strands of 19 bare wires of 4.15 mm diameter and 130 kg/mm² breaking strength.

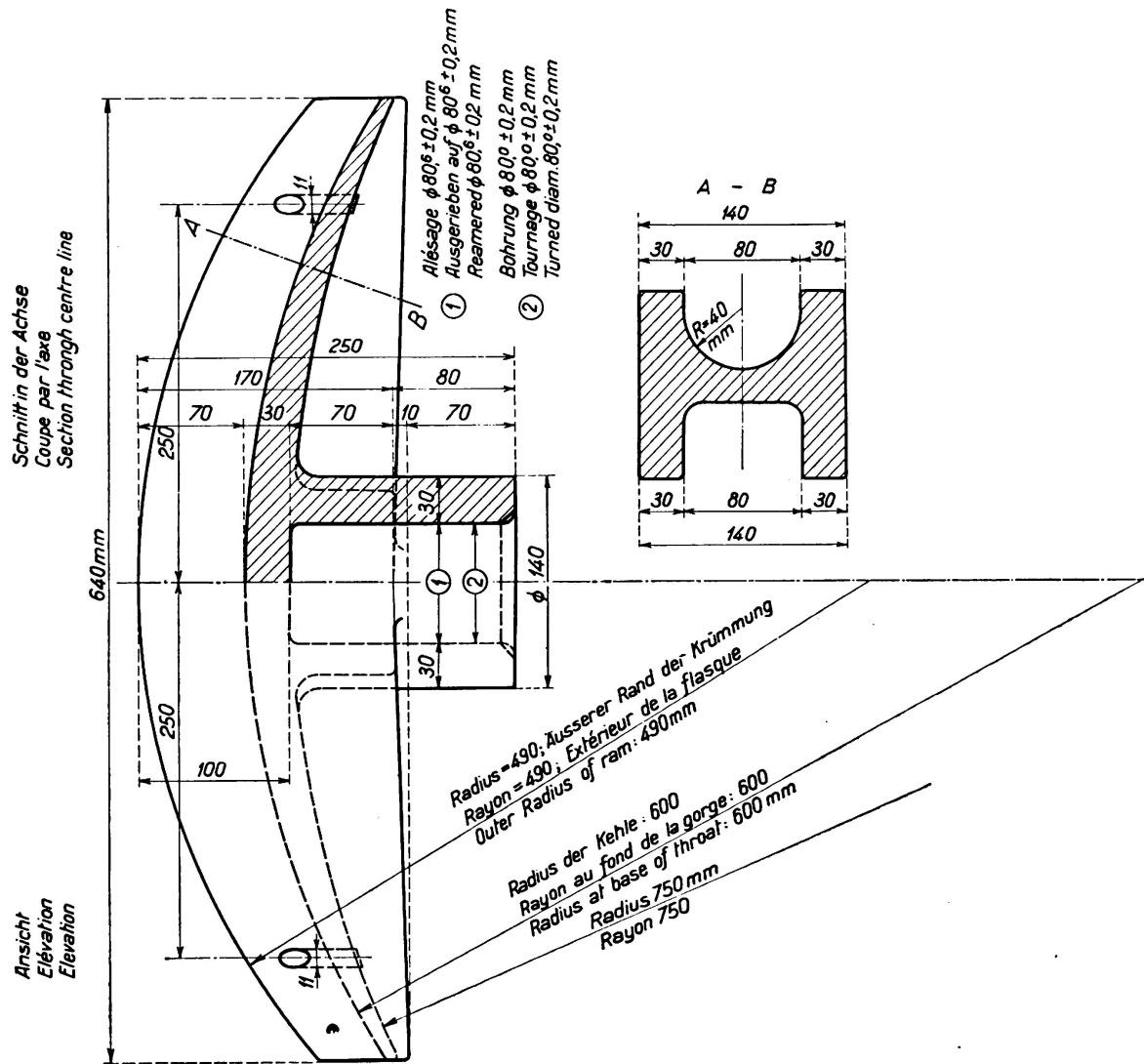

Fig. 14.

Lateral reinforcement of pressure ducts. Presse ram.

2) *Anchoring ferrules.* Fig. 12, already commented upon in chapter II, gives a clear idea of the solution adopted.

3) *Tubes and flat boxes.* The protecting member for the cable includes three lengths of tubing and two flat boxes. For convenience in fabrication (of which details are given later) each length of tube has been formed in two parts: a half tube of Ω -section and a closing plate. The half tube is bent to a radius of 2.50 m. The flat boxes, the object of which is to allow of deforming the cable, are built up as shown in Fig. 13 and consist of the box itself, and the lid,

the latter being furnished with a short tube which forms an orifice for access to the cable after concreting.

4) *Mushrooms*. The cast steel mushroom (Fig. 16) is housed inside the box, and it is through this that the jack acts upon the cable; its object is to impose a suitable radius of curvature on the latter. The mortar poured between the mushroom and the lid of the box forms the packing which allows the jacks to be removed.

5) *Reinforcements*. No circular reinforcement is provided. A few bars of 20 mm diameter spaced at 0.40 m form a very light longitudinal reinforcement, which is in fact considered to be superfluous in view of the fact that the extent of the longitudinal stress for each hoop is known. At the downstream end of

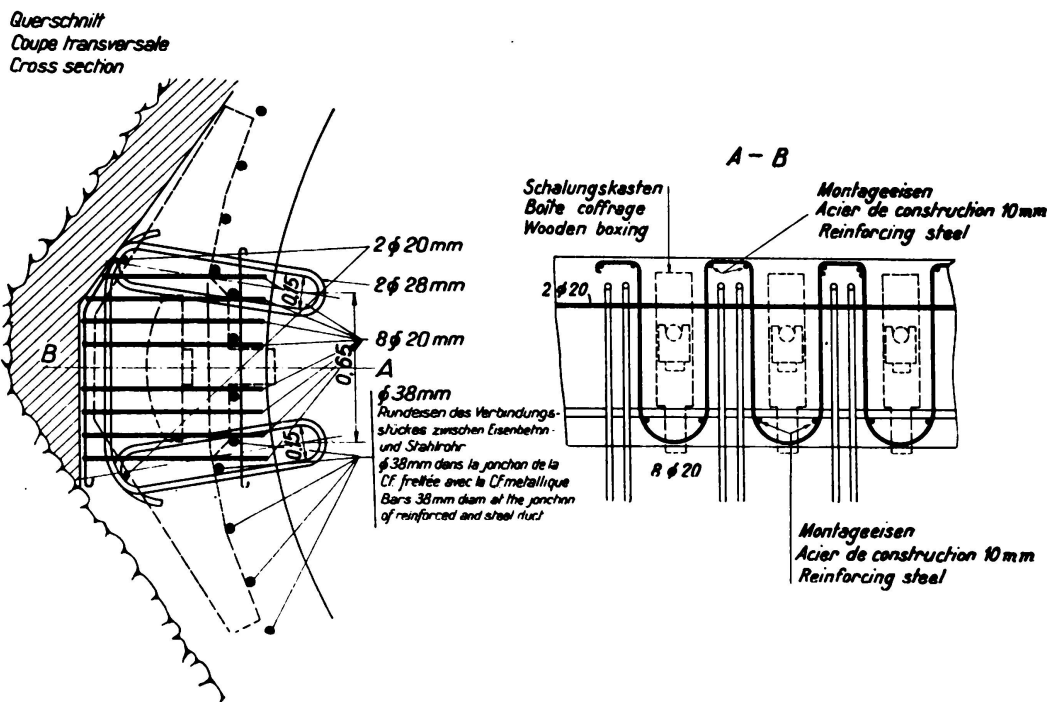

Fig. 15.

Pressure ducts. Laterally reinforced portion.

Reinforcement round for wooden boxing read steel boxing press rams.

the hooped construction the longitudinal reinforcement is considerably strengthened through the presence of the anchorage bars of the steel piping.

The most important of the steel parts are those required on the one hand to anchor the jacks and on the other hand to take up the permanent reaction of the cable, which, to the right of the flat boxes, is exerted on the small thickness of concrete between the lids of the boxes and the intrados of the pressure pipe. Fig. 15 shows the arrangement adopted, including also the longitudinal bars of 38 mm diameter serving as anchorage for the steel piping.

At the centre of each space between consecutive cables are placed two stirrups of 28 mm diameter, made from a single length of bar in two parallel arms, 7 cm apart. These form two loops of 150 mm diameter projecting inside the tunnel, at levels respectively 0.325 m above and below the horizontal axis of the conduit. In this way the jack for tensioning the cable can bear on

four double loops, each of which, under normal stress, is capable of withstanding a tensile load of 30 tons.

The pressure of 100 to 120 tons exerted by the mushroom, after packing, against the strip of concrete enclosing the lid of the box, is distributed

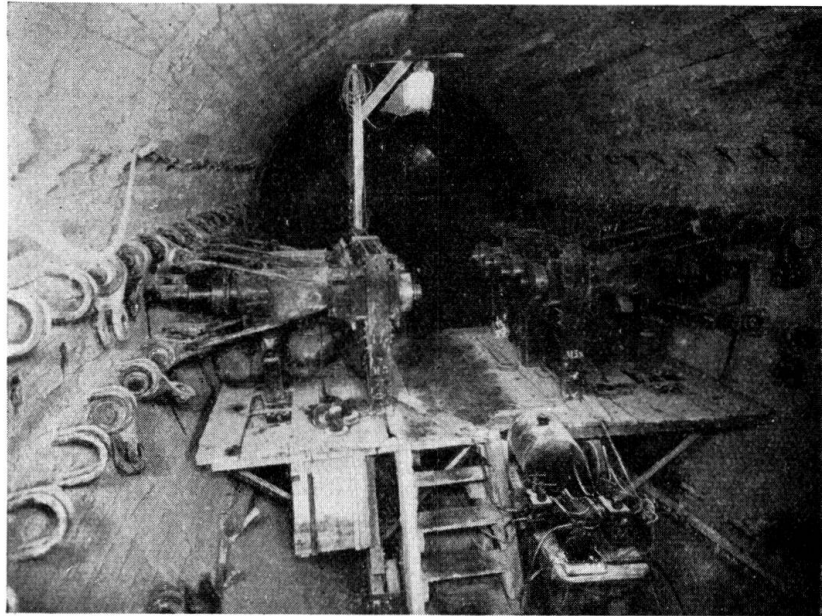

Fig. 16.

Movable stand for presses.

throughout the thickness of the pressure pipe by horizontal bars uniformly curved to a large radius so as to bind the said strip.

Finally, the front of each anchoring ferrule on the end of a cable is pro-

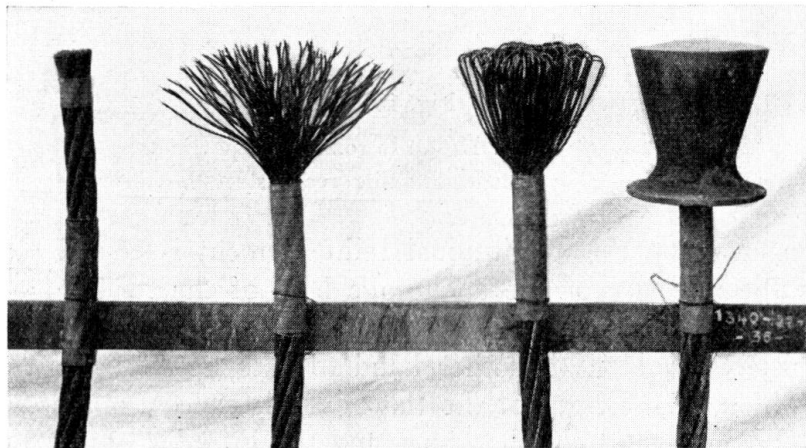

Fig. 17.

Preparation of rope anchors.

vided with a double grillage of 8 mm bars with 6 cm mesh, binding the concrete which is heavily compressed by the ferrule (Fig. 10).

6) *Trolley for jacks.* The jacks are carried on trolleys which run on a temporary track. Two such trolleys were used, one carrying two jacks and the other

four (Fig. 16). Each jack stands on a metal base carried by the trolley but is free to move 10 to 15 mm in all directions relatively to the base. Passing through the base are two spindles of 110 mm diameter, screwed and provided with nuts; these are situated 25 cm on each side of the jack, in the same horizontal plane. On each spindle is a loose pulley over which is passed a cable with a hook at either end, enabling it to be attached with the aid of bars, etc. to the anchoring hooks described in paragraph 5 above.

When not in action the jacks are carried by a screw centering device which enables them to be rapidly aligned with the axes of the orifices giving access

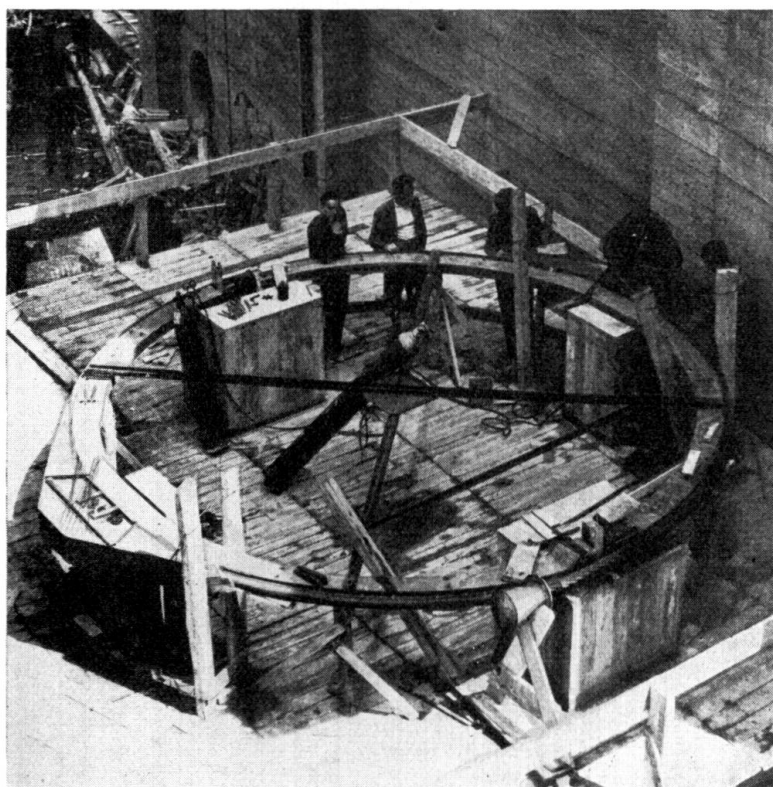

Fig. 18.

Preparation of reinforcing hoop.

to the cables. When in action they are borne on the anchorages, and the play provided in the base ensures that the trolley shall be unaffected by the forces developed.

IV. Construction of the hooping.

1) *Preparation of the hooping cables.* The cables are supplied in lengths of 18.5 m, this being sufficient to form one hoop. They are bound at a distance of 32 cm from each end. An anchoring ferrule is slipped over each end of the cable, and the latter is unstranded into wires hooked at their ends. The tuft so obtained is sealed into the ferrule with mortar made by mixing 50 kg of ciment fondu with 50 kg of sand of 0—5 mm gauge. Fig. 17 shows the stages of this work.

2) *Preparation of the hoops.* Mr. Pfaff, Engineer of Public Works, to whom all the arrangements for the hooping are due, conceived the idea of forming the hoops into rigid shapes before transporting them underground rather than assembling the cables, sheaths and boxes on the spot, which would have

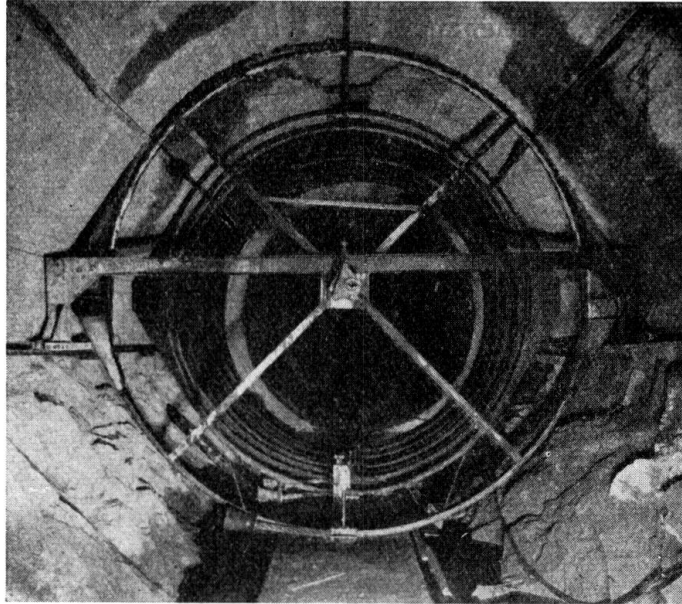

Fig. 19.

Placing reinforcing hoops into position.

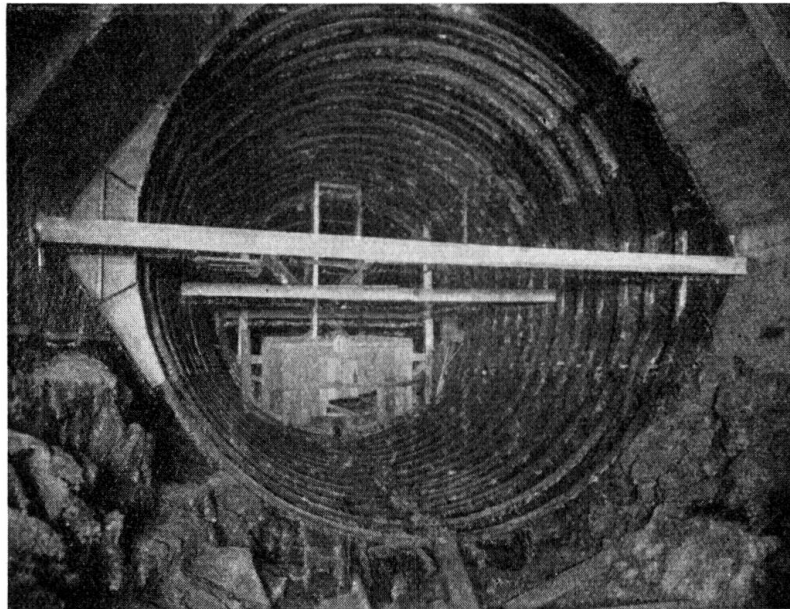

Fig. 20.

Reinforcing hoops after placing into position.

been very awkward to do. For this purpose he built, outside the tunnel, an assembly platform of two moveable half-centreings of reinforced concrete made with ciment fondu, to a radius of 2.5 m, arranged horizontally 1 m above ground level (Fig. 18).

The cable is first fixed around this centring and is temporarily placed on the packings; then the three portions of closing plate for the sheath are inserted between the cable and the centring; next the two ends of the cable are pressed together at their junction with the aid of a clamp; two screw jacks

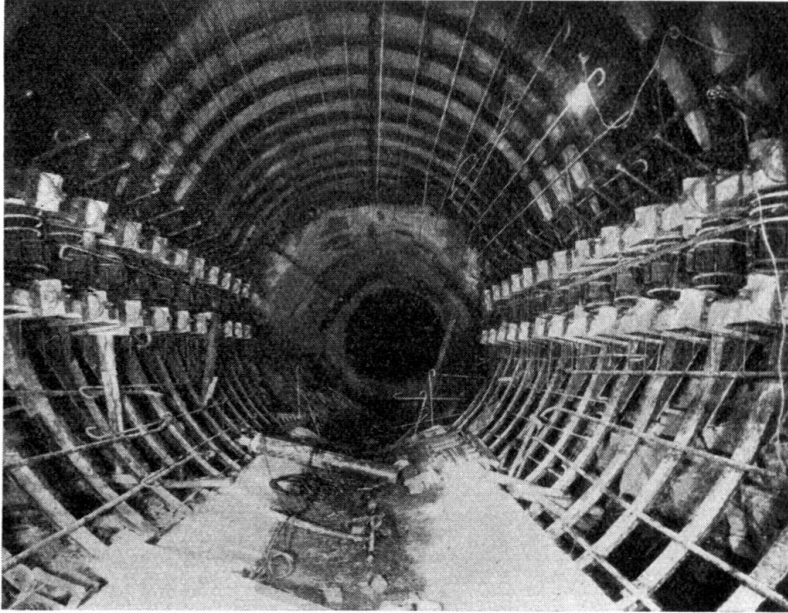

Fig. 21.

Duct before concreting.

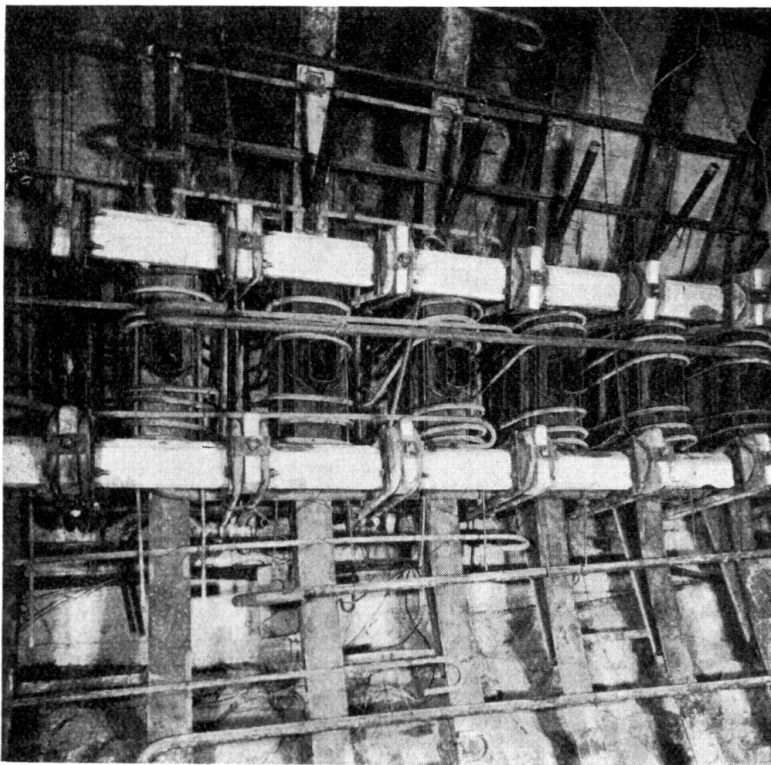

Fig. 22.

Centring boxes and reinforcement before concreting.

between the ends of the half-centreings lightly stretch the cable and give it a diameter of exactly 5.0 m. Finally the Ω -shaped sheaths and the boxes without their lids are placed in position and are spot welded to the closing plate.

At least three hours were required to prepare a hoop, and the error in its diameter is only a few millimetres.

3) *Erection of the hoops.* The rigid whole formed in this way, some 600 kg in weight, has to be transported and erected in the tunnel, the cross section of which is barely larger than that of the hoops. It is lifted by a crane and transported on a trolley which runs on two side tracks (Fig. 19); it is then adjusted into place and attached to rows of angles sealed into the rock so as to avoid later displacements (Fig. 20).

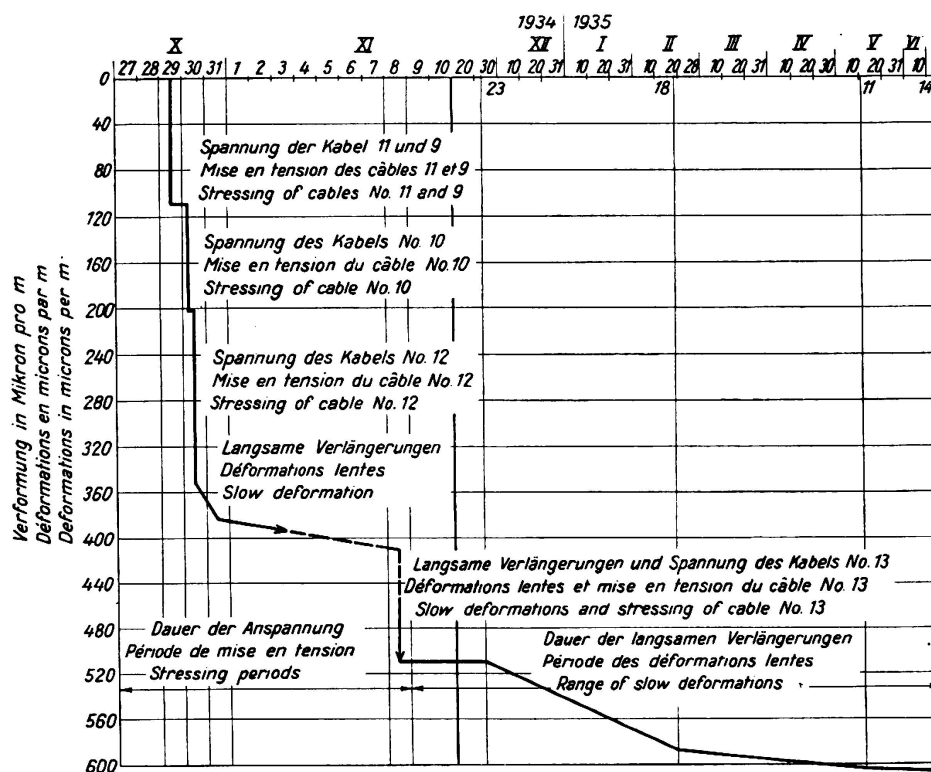

Fig. 23a.

First period.

Stressing of cables 9 to 13 (from 29th October till 8th November 1934) and slow deformations (until 14th June 1935).

4) *Sequence of operations in the construction.* The lower portion of the pipe is concreted first and the mushrooms, covers of boxes and reinforcements are next added in that order. Figs. 21 and 22 show the appearance of the pipe after these operations. The concreting is then carried out. The concrete was made from crushed gravel of 70 mm gauge, except in the reinforced parts where it was necessary to reduce the gauge to 30 mm. The mixture adopted contained 400 kg of "iron Portland" cement per m³.

5) *Tensioning and packing the hoops.* The tensioning of the hoops is undertaken at the end of a fortnight allowed for hardening (Fig. 16). The trolley

carrying the jacks is brought opposite the cable to be tensioned and each jack is aligned with the orifice in the lid of the flat box; a thrust bar is inserted between the mushroom and the ram of the jack, and the jack is packed in position. The side slings are hooked to the anchoring loops and are lightly stretched by means of the nuts on the threaded spindles.

Oil under the appropriate pressure for tensioning the cable is then forced into the jacks by starting up a small electric pump which feeds two opposed pistons simultaneously. At any time the amount of tension in the cable can be found from a table, being expressed as a function of the pressure exerted by the jack, and of the deformation of the cable as measured by the movement of the mushroom transmitting the pressure. When the tension in the cable

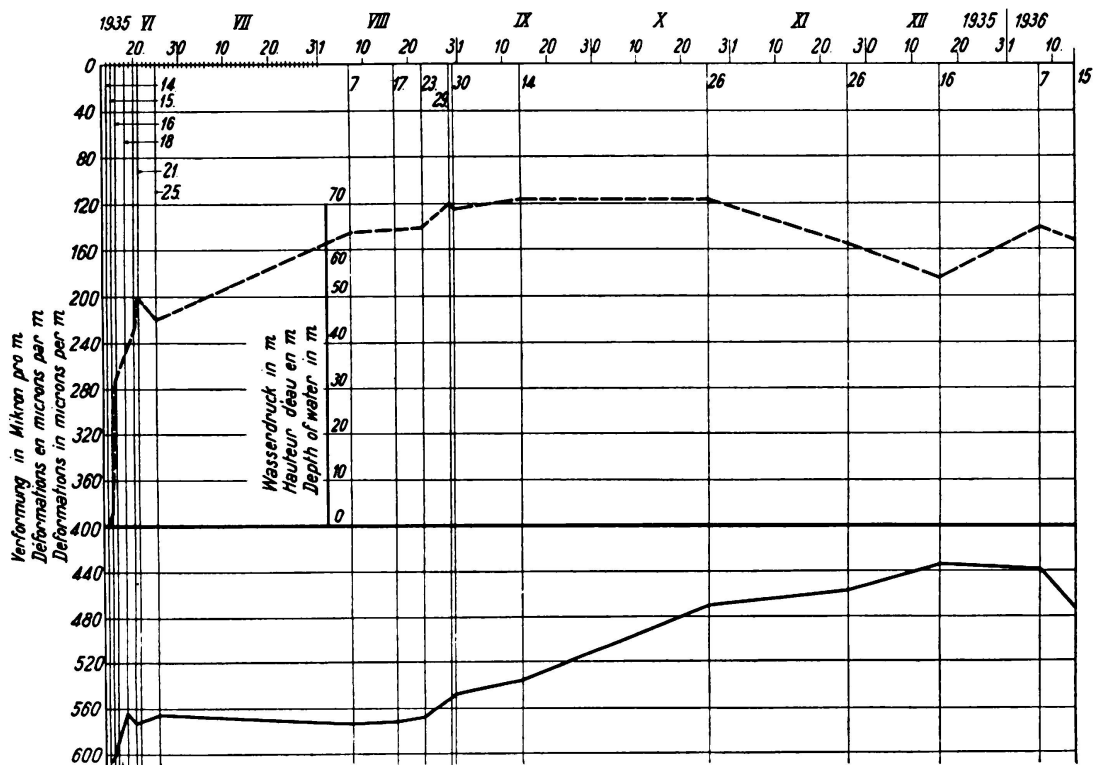

Fig. 23b.

Second period. Duct under water pressure. Deformation diagram of duct N° 1 (measured by acoustic methods).

reaches a value of about 130 tons the jacks are locked by their safety nuts and the flat boxes are filled with mortar containing $\frac{1}{3}$ ciment fondu. After about seven hours the mortar is hard enough to withstand the reaction of the cable, which is of the order of 100 tons. The jacks are then removed with due precaution and passed to the next cable. It may be added that the movement of the mushroom is about 13 cm and the drop back on taking out the packing is only about 1 mm which releases only a negligible proportion of the tension in the cable.

The whole tensioning operation does not take longer than 12 hours, so that

working continuously it is possible to stretch two cables a day with one pair of jacks.

6) *Finishing operations on the pipe.* The tubes are then filled with cement by injection in order to preserve the cable, and injections are also made into the junction between concrete and rock and into the rock cleavages. Finally the anchoring hooks are removed and the inside of the pipe is covered with the cement gun.

V. Control of the hooping work. Control in Service.

A considerable number of the acoustic controls invented by Mr. Coyne have been applied to the thickness of the concrete lining for the purpose of measuring the state of compression therein and of ensuring the maintenance of the proper condition in service.

Fig. 23 gives, as an example, a picture of the state of compression in the concrete between cables Nos. 11 and 12 of pipe No. 1. In this graph three periods may be distinguished:

1) The period during which the cables adjoining the zone in which the acoustic device is fitted were being tensioned (from October 27th to November 8th, 1934): here the curve clearly shows the changes in the compressive stress of the concrete at the times of tensioning the five cables numbered 9—10—11—12—13 which bracket the point in question.

These readings fully confirm what had been established by the preliminary experiment, namely that the zone of influence of any one cable extends over more than one metre on each side, giving the assurance that the pipe is compressed very uniformly despite the considerable spacing of the hoops. The deformation at the end of this period amounts to 500 microns per metre, and if, as the concrete is not very old, the modulus of elasticity be assumed at 150,000 kg/cm² this corresponds to a stress of 75 kg/cm².

2) The period of slow deformations (from November 8th, 1934 to June 14th, 1935): herein the concrete is continuing to deform under the sustained action of the loads applied to it. The plastic strain exceeds 100 microns per m.

3) The period in which the pipe first became filled with water (from June 14th, 1935): under the action of the internal water pressure part of the compression in the concrete is released. Under a hydraulic head of 71 m the decompression amounts to 135 microns per m. If the pipe were free, without the rock adding to the resistance, the decompression would be about 300 microns per m.

In Fig. 23 it is possible to perceive a highly satisfactory parallelism between variations in the compression of the concrete and variations in the water pressure. Such small inconsistencies as are present in the curve may almost certainly be attributed mainly to variations in the temperature of the water, which causes a slight error in reading the acoustic controls.

If, now, a comparison is made of the compressive stresses and amounts of decompression obtained at the different points tested — taking account of the

variations in thickness of the pipe — a satisfactory agreement between the results is seen to be present as indicated in the following table:

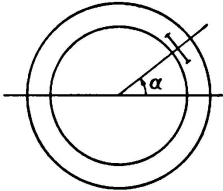
No. of control	Nos. of cables on each side of the control	Position of the control in the section α (1)	Compressive stress after hooping	Residual compressive stress under a head of 71 m of water	Remarks
(1)	(2)	(3)	(4)	(5)	(6)
1	0—1	$\alpha = 60^\circ$	300	170	(1) meaning of α : 
3	7—8	$\alpha = 90^\circ$	580	440	
4	11	$\alpha = 135^\circ$	465	360	
10	11—12	$\alpha = 120^\circ$	530	420	
11	11—12	$\alpha = 60^\circ$	605	470	
13	12—13	$\alpha = 0^\circ$	450	220	
14	14—15	$\alpha = 90^\circ$	270	170	
18	38—39	$\alpha = 90^\circ$	470	345	

Summary.

The system of hooping described in this note is a new application of the general constructional method which consists of subjecting the work to pre-established strains in order to improve the distribution of those stresses which will ultimately come to bear. The clever ways in which this principle has already been applied, notably by Mr. Freyssinet and Mr. Coyne, are well known.

Very special difficulties were encountered in the present instance, owing to the work being carried out underground, and it follows that the method can be much more readily applied, under incomparably simpler conditions, for the hooping of concrete pipes in the open air. We are of opinion that it is a method capable of many applications, especially for pipes of large diameter.

Leere Seite
Blank page
Page vide