

Some recent steel bridges in Sweden

Autor(en): **Nilsson, E.J.**

Objekttyp: **Article**

Zeitschrift: **IABSE congress report = Rapport du congrès AIPC = IVBH
Kongressbericht**

Band (Jahr): **2 (1936)**

PDF erstellt am: **21.07.2024**

Persistenter Link: <https://doi.org/10.5169/seals-3225>

Nutzungsbedingungen

Die ETH-Bibliothek ist Anbieterin der digitalisierten Zeitschriften. Sie besitzt keine Urheberrechte an den Inhalten der Zeitschriften. Die Rechte liegen in der Regel bei den Herausgebern.

Die auf der Plattform e-periodica veröffentlichten Dokumente stehen für nicht-kommerzielle Zwecke in Lehre und Forschung sowie für die private Nutzung frei zur Verfügung. Einzelne Dateien oder Ausdrucke aus diesem Angebot können zusammen mit diesen Nutzungsbedingungen und den korrekten Herkunftsbezeichnungen weitergegeben werden.

Das Veröffentlichen von Bildern in Print- und Online-Publikationen ist nur mit vorheriger Genehmigung der Rechteinhaber erlaubt. Die systematische Speicherung von Teilen des elektronischen Angebots auf anderen Servern bedarf ebenfalls des schriftlichen Einverständnisses der Rechteinhaber.

Haftungsausschluss

Alle Angaben erfolgen ohne Gewähr für Vollständigkeit oder Richtigkeit. Es wird keine Haftung übernommen für Schäden durch die Verwendung von Informationen aus diesem Online-Angebot oder durch das Fehlen von Informationen. Dies gilt auch für Inhalte Dritter, die über dieses Angebot zugänglich sind.

VIIa6

Some Recent Steel Bridges in Sweden.

Neuere Stahlbrückenbauten in Schweden.

Quelques nouveaux ponts métalliques en Suède.

Major E. J. Nilsson,
Hafenverwaltung der Stadt Stockholm.

A number of comparatively large steel bridges, both road and railway, have been erected in Stockholm during the last few years. Although these bridges cannot compare in size with the very big bridges abroad, they are nevertheless noteworthy as regards design, architectural features, local conditions, and method of erection. The present notes briefly describe just a few of the road bridges recently completed or at present building in Stockholm.

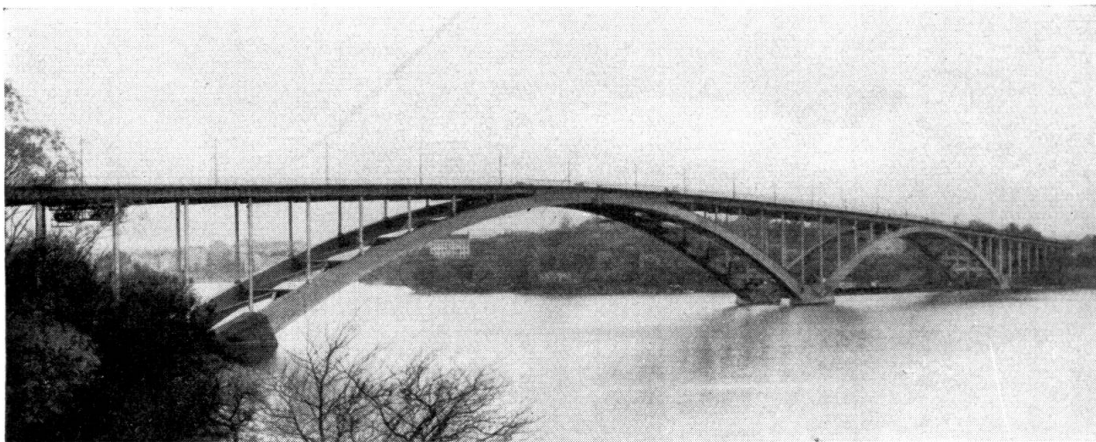

Fig. 1. Western Bridge. General view.

West Bridge:

A Road Bridge over Lake Mälaren, Stockholm.

The West Bridge forms part of the main traffic route between Kungsholm and Söderholm in Stockholm. It comprises two arches spanning the Riddarfjärd, one of which has a span of 168 m and the other 204 m, connecting with viaducts of 12.9 m span as shown in Fig. 1. The overall length of the bridge is 601.5 m, and width $2.5 + 19.0 + 2.5 = 24$ m.

The roadway is 30 m above mean water-level, and is reinforced concrete on longitudinal and transverse girders. It has projecting footways. The headway for navigation in the main opening of the arch is 24 m above mean water-level over a width of 50 m at right angles to the navigation channel, and 26 m over a width of 19 m.

The substructure consists of separate concrete foundations carried down to the rock. The average distance apart of the piers, which are stone-dressed at water-level, is 18 m measured across the bridge. The max. depth of the foundations below water-level is 14 m. The foundations are put in inside cofferdams or caissons, in open pits, and partly under water.

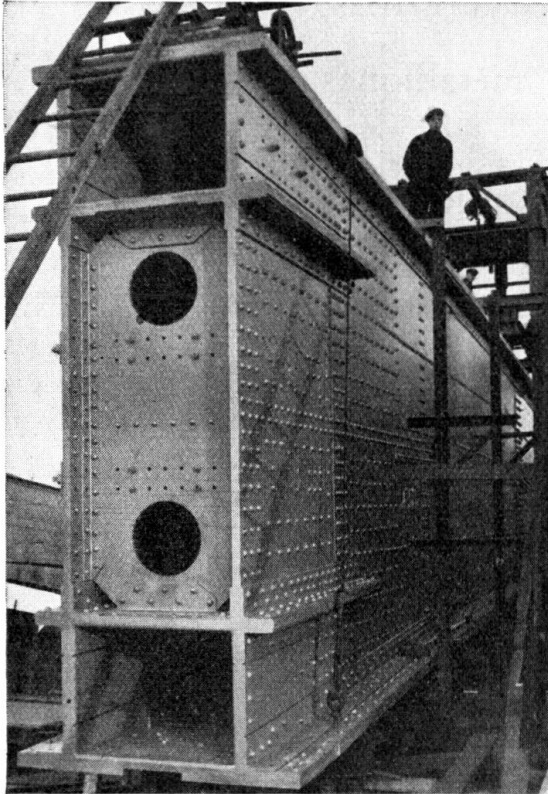

Fig. 2.

Western Bridge. Section of arch at springing.

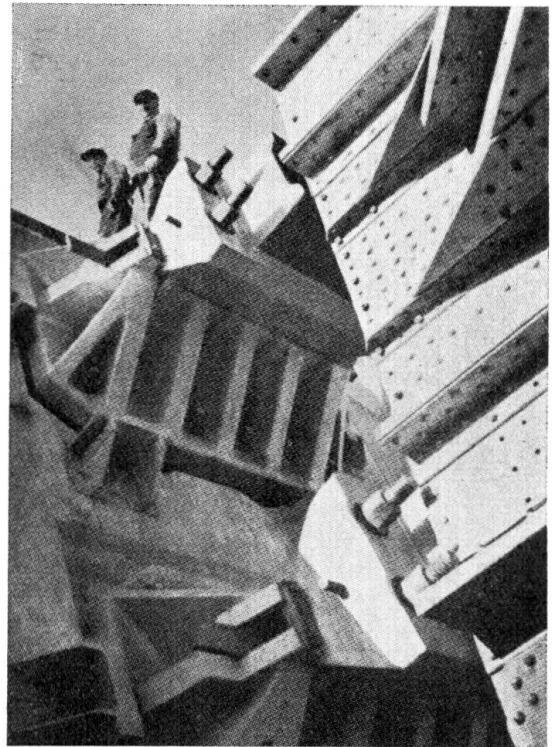

Fig. 3.

Western Bridge. Support of arches at springing

Steel Superstructure.

Each arch consists of two arched box girders anchored to the abutments and unhinged at the apex. The main girders are 18 m between centres. The overall height at the apex and at the abutments is 2.0 and 4.0 m respectively for the smaller arches, and 2.5 and 4.6 m for the larger ones. The cross-section of the arches and the method of supporting them at the abutments are shown in Figs. 2 and 3. The arches are connected by horizontal bracing. The ratio between the rise and span of the arches is 1/8.2. The arches, including the bracing, are rivetted throughout, the former being made of St 52 Structural Steel and the latter of Steel 44.

The roadway deck consists of rivetted transverse girders spaced 12.9 m apart, and 10 welded main girders 2.13 m between centres in each panel. In the middle of each bay, the main girders are connected by means of transverse load-distributing girders. Below the roadway deck is a horizontal bracing of welded \perp -bars rivetted at the points of intersection. The ferro-concrete roadway platform, as also the roadway deck, is supported by tubular,

partially welded columns 600—700 mm diameter. Figs. 4 and 5 show the construction of the roadway and the columns.

The transverse girders are made of St. 52 Steel, and all the other components of the roadway deck, including columns and horizontal bracing below the roadway, of St. 44 Steel.

The contract specified that the transverse girders should also be welded. However, for reasons which had nothing to do with any objections to welding, these girders were rivetted.

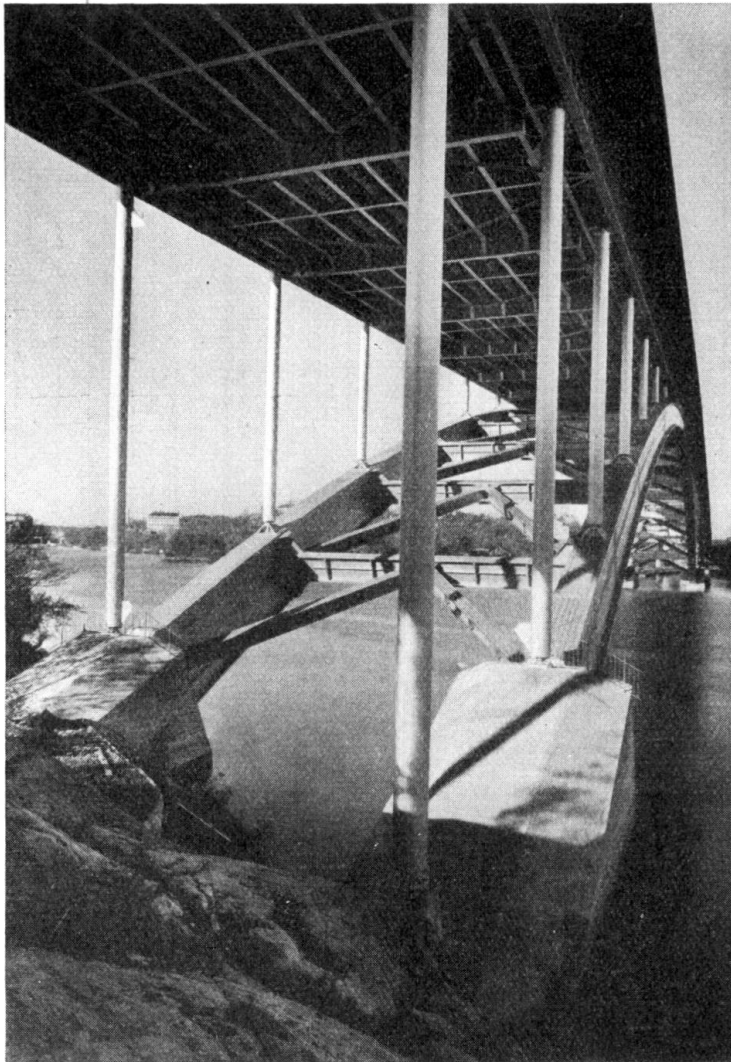

Fig. 4.
Western
Bridge.
Road decking
seen from
below.

Erecting the Steelwork.

The erection of the steelwork was an interesting operation. The sections of the arches, in lengths of roughly 13 m (or the width of a bay) and weighing 65 tons maximum, were transported on craft from the shops at the Ekensberg Yard situated $1\frac{1}{4}$ miles from the site. They were then laid on a fixed staging and rivetted up (Fig. 6). The halves of the arches were then each pushed on to a separate cross-track, towed to the site with the help of a floating dock (Fig. 7), and let down on to temporary piers. When two

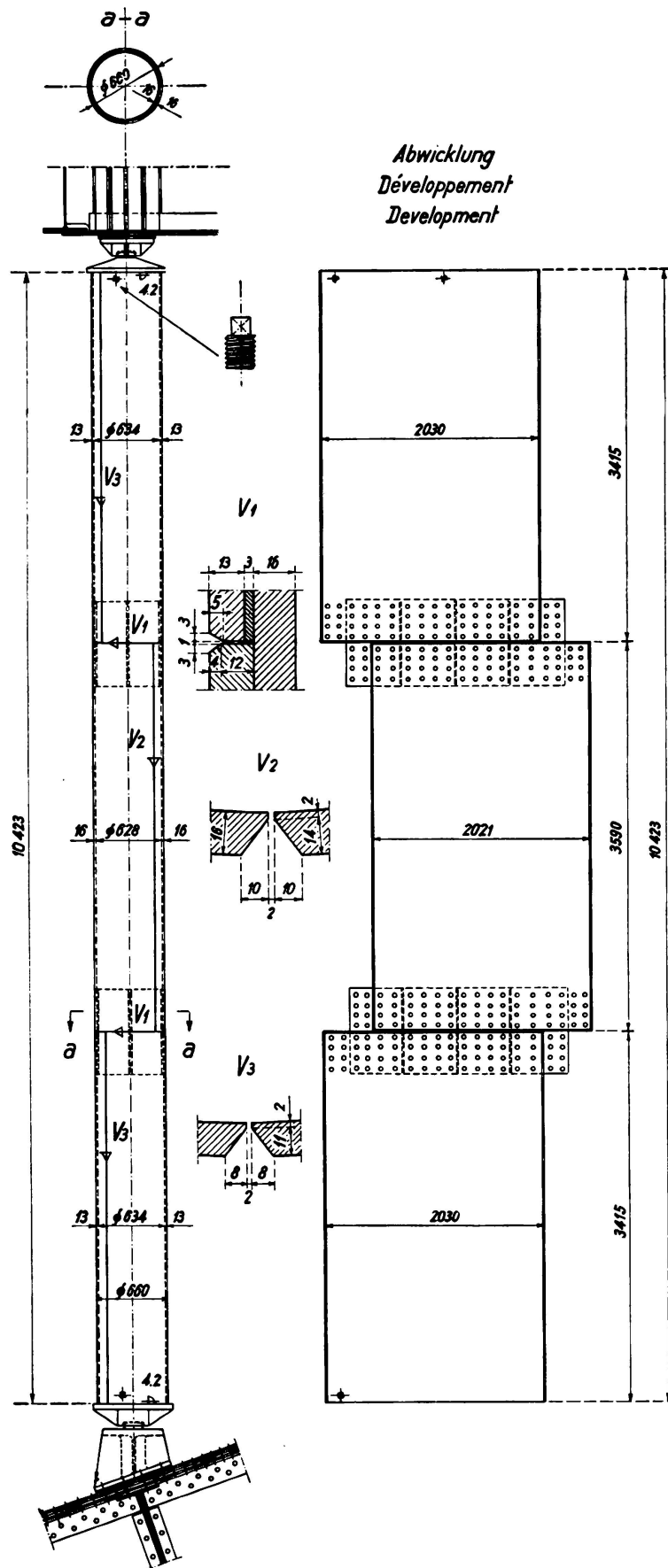

Fig. 5.
Western Bridge. Cylindrical column supporting road construction.

halves of the arch had been braced together, they were lifted in pairs by hydraulic presses mounted on an auxiliary derrick located in the centre of the arch opening, and by Gall chains (Fig. 8), the arches turning about pivots which

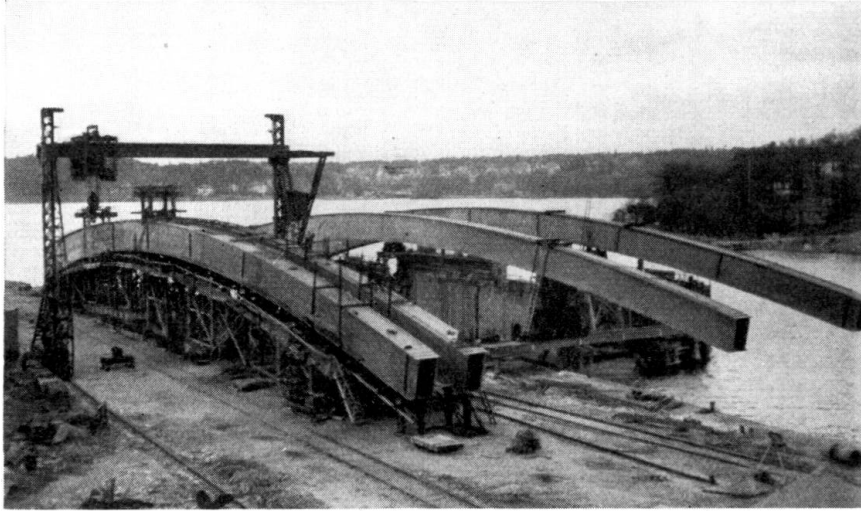

Fig. 6. Western Bridge. Half of arch at Ekensberg Wharf.

were capable of being adjusted in any direction by presses. When they had reached the proper height, the arches were controlled by means of hydraulic presses and temporary cast steel hinges at the apex, so that the optimum restraining moments at the abutments were achieved when all the load and other influences had been allowed for. The tops of the arches were then rivetted together.

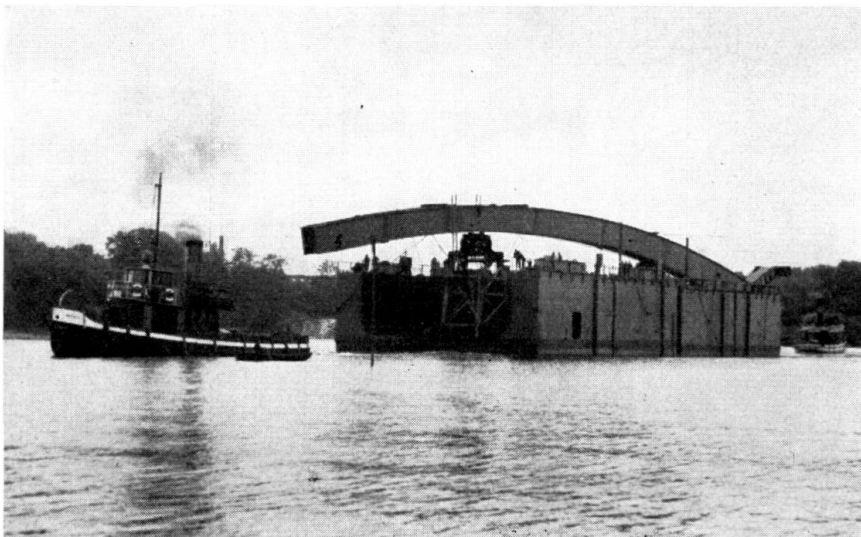

Fig. 7. Western Bridge. Half of arch being transported to site.

The roadway deck, including tubular columns, etc., were built up as shown in Fig. 9, by means of a derrick crane and other auxiliary equipment. It took 2—3 days to assemble a section in this way. The total weight of the steel

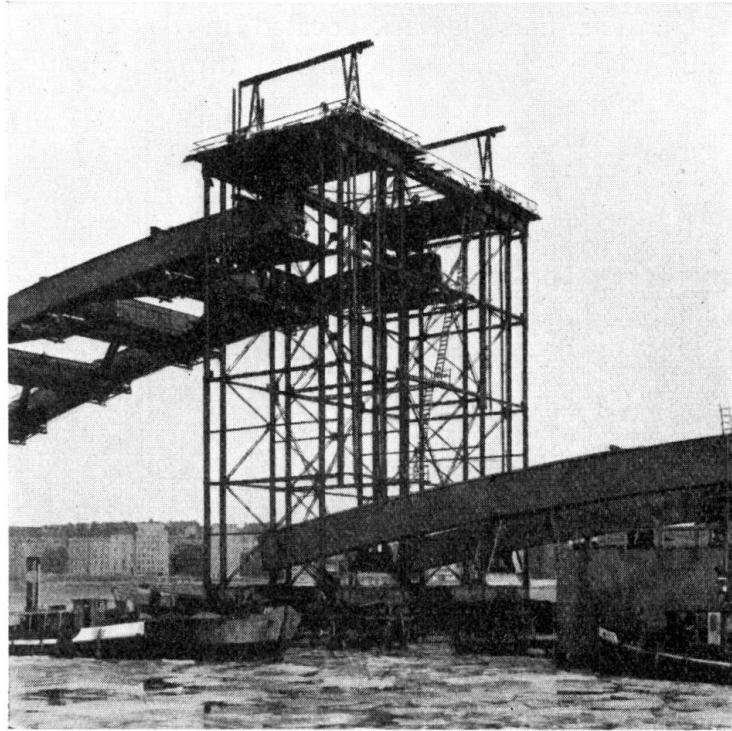

Fig. 8.
Western Bridge.
Auxiliary tower
for raising
arches.

portion of the structure is about 7000 tons, approximately 2000 tons of which are welded. The West Bridge, and the Pårsund Bridge following it, were opened for traffic in 1935. Including the substructure and roadway platform, the bridge cost roughly 6,175,000 Kroner to build.

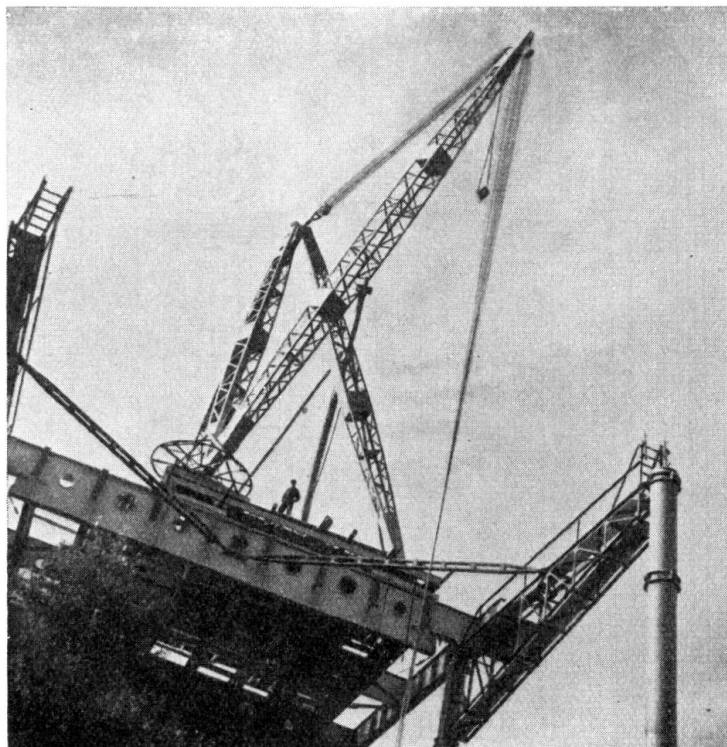

Fig. 9.
Western Bridge.
Assembling the
Viadukt.

Pålsund Bridge.

The other bridge in the line of traffic mentioned above is the Pålsund Bridge, connecting the island of Långholm with Sötermalm. This is a comparatively small bridge, but is interesting because the steelwork is of the completely welded type.

It consists of a 56 m span above the Pålsund, and connecting viaducts of 1 m span at either end (Fig. 10). The total length of the bridge is 276.6 m, and the width of the roadway 24 m. The roadway deck and roadway platform are very similar in design to those of the West Bridge, except that the number of girders in



Fig. 10.

Pålsund Bridge. General view.

each bay is 7 instead of 10. A notable feature is the method of designing and making the cross-girders and arches. The cross-girders, 19.5 m long and 1.13—2.06 m high, consist of a 17 mm gauge web, and flange plates of 450×60 mm at the centre of the girder, and 300×60 mm at the supports (Fig. 11). The “lugged” flanges are welded at two points by vee butt joints, and the webs are stagger-butt welded in the middle of the girder. This latter type of welding was modified whilst work was proceeding, until the joint finally assumed the form shown in Fig. 11. The transverse girders, weighing about 12 tons each, were completed in the shops and conveyed on special trucks to the site.

The double-hinged arches of the main span were practically built up on the site, where the necessary equipment had been provided. The arches are parabolic and of box-section (Fig. 12). Each half of the arch was completed in four sections, which were then placed on a derrick and welded up (Fig. 13). Both the horizontal and vertical joints were vee-welded. The internal stiffening of the arches was carried out by means of transverse partitions or bulkheads with manholes at distances of roughly 6 m. The lower flanges also had manholes through which the men could get access to the inside of the arch for

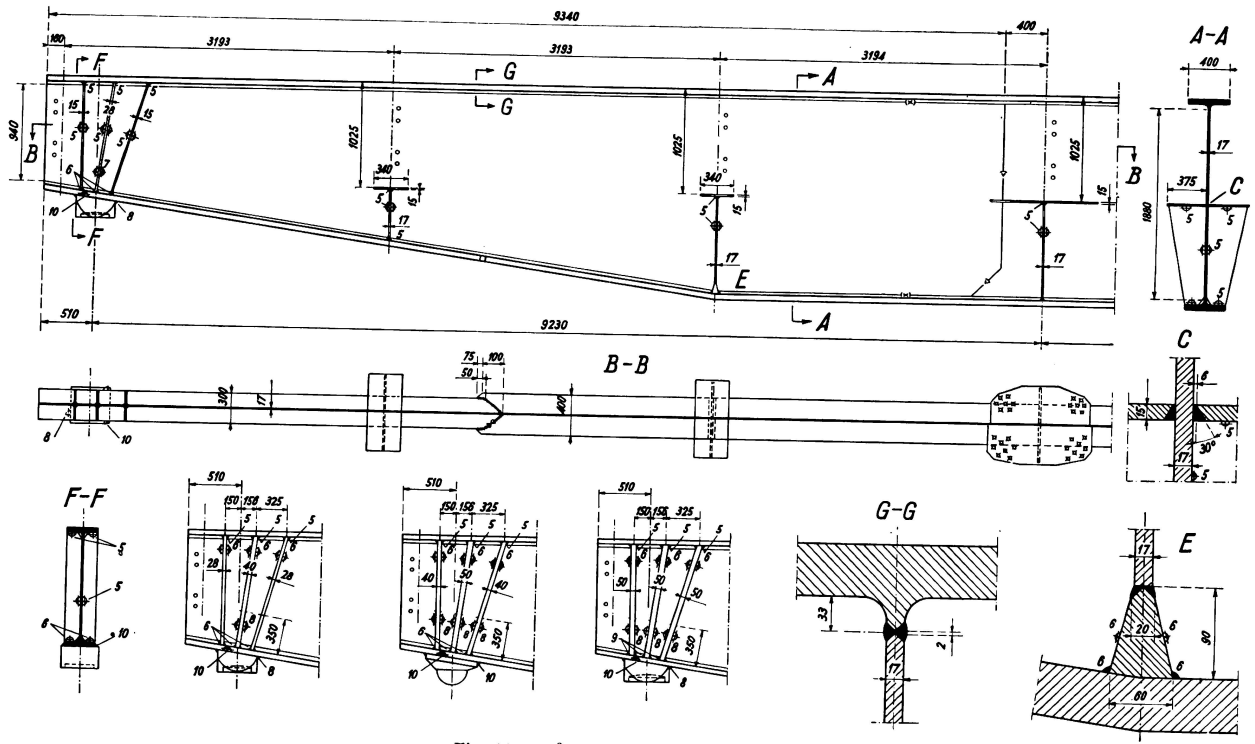

Fig. 11. Pålund Bridge. Cross beams.

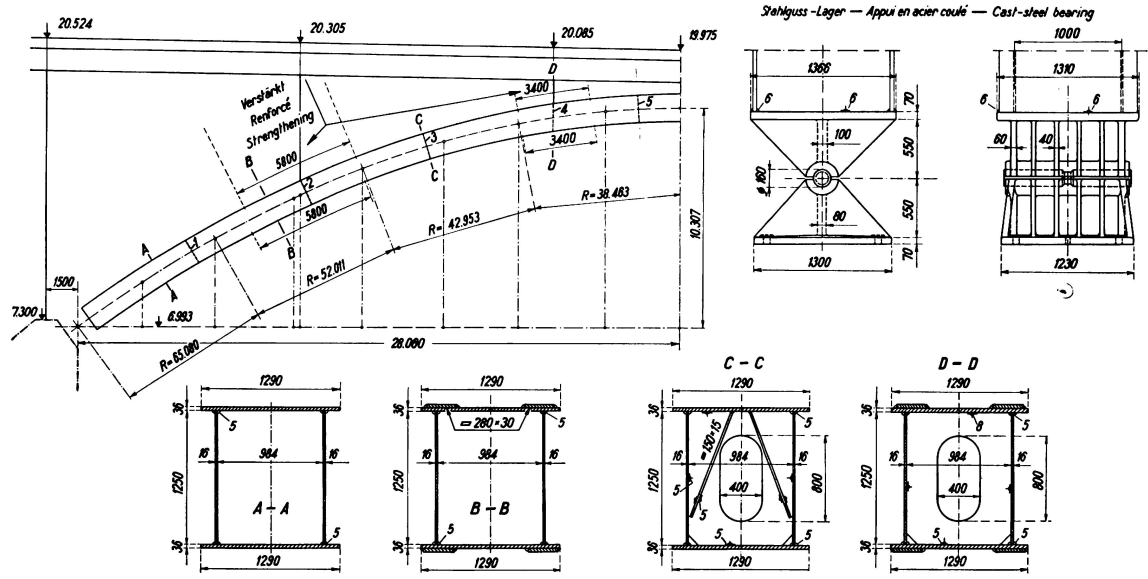

Fig. 12. Pålund Bridge. Arch girders.

inspecting the paintwork, etc. At the places where the maximum moments occur, the flanges of the arch are reinforced by butt-straps, but were only butt-welded at the joints.

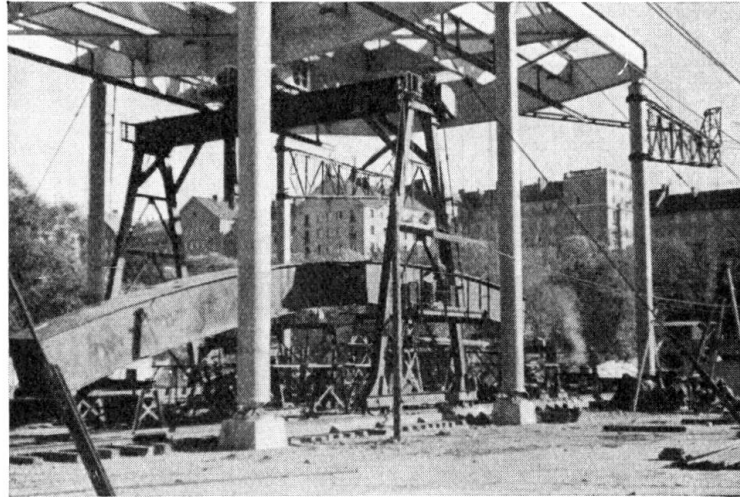

Fig. 13.
Pålssund
Bridge.
Welding arch
sections
at site,

The following method was adopted for erecting the arches. By means of the above-mentioned derrick and trucks built inside it, the halves of the arches were run out on a track over the Sound, and there moved on other trucks and lines in the transverse direction of the bridge, and manoeuvred into the proper position. With the aid of hoisting tackle and temporary latticework trestles,



Fig. 14.
Pålssund
Bridge.
Erecting the
arches.

the halves of the arches were then each raised singly to the correct level (Fig. 14), pivoting on temporary pivots on the abutments. The halves of the arches were then welded together at the apex in the same way as the other butt-joints.

The total weight of the steel superstructure of the bridge is about 1100 tons, including steel castings. The transverse girders account for 265 tons. The latter are made of St 52 Structural Steel, and the other parts of St 44 Steel. The total cost of the bridge is 1,230,000 Kroner.

St. Eriks Bridge.

Last year, a start was made with the construction of new steel superstructure for the St. Eriks Bridge in Stockholm. The present bridge, only 30 years old, consists of three arch openings each of 40 m span, and two subsidiary openings with lattice superstructures each of 26.7 m span at either end of the bridge (Fig. 15). The total length of the bridge is 226 m, with a useful width of 18 m. In order to make it suitable for through traffic, for which the West and Pålund Bridges were built, the St. Eriks Bridge is now to be widened to 24 m and adapted to carry the same load as the other two bridges. During the conversion, provision is also to be made below the roadway of the bridge for a second deck to carry a double-track suburban railway bridge. When completely converted and rebuilt, the bridge will appear as shown in Fig. 16. The present foundations (put in by

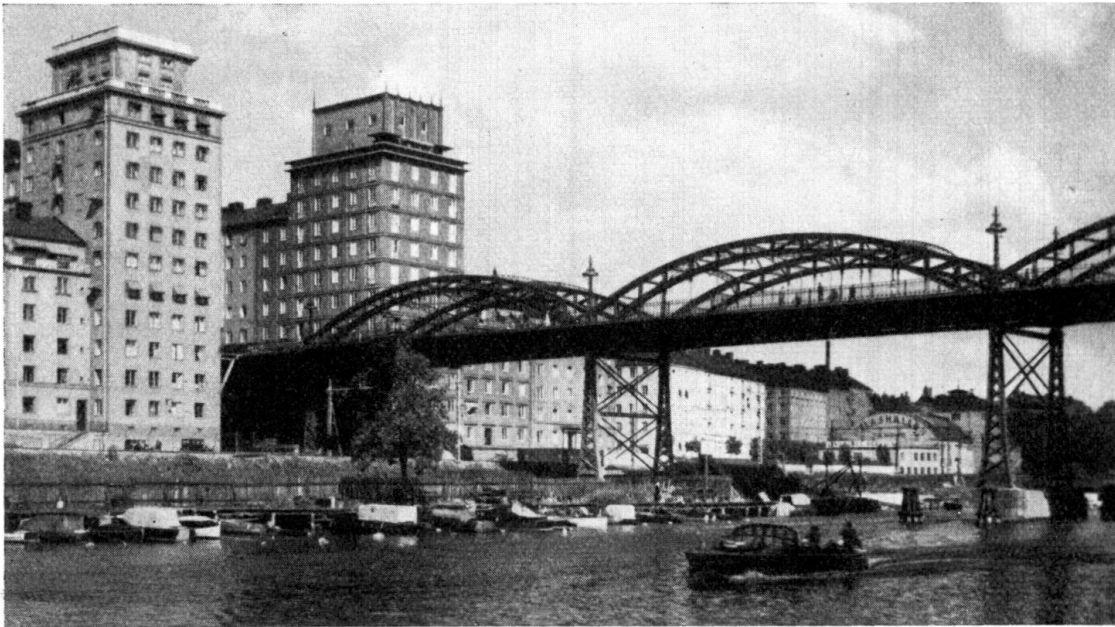

Fig. 15.

St. Erik's Bridge. The old bridge.

compressed air) will remain as they are after the concrete masonry has been strengthened by injecting cement. After the steel supports on which the existing steel superstructure rests have been grouted in and widened by brackets (Fig. 16), a new steel superstructure will be put in place, consisting of six continuous main girders, and transverse girders in the centre portion of the bridge. All the new structural parts will be welded throughout.

The main girders have webs 2 m high, and are composed of single unstiffened web-plates and fillet-welded flange-plates. The design of the steel superstructure is shown in section in Fig. 17. The erection joints of the main girders, put in place in the first stages of construction, together with the cross-bracing joints, will be rivetted, but subsequently all the joints will be welded on the site, partly to avoid the noise of rivetting.

The replacement of the steel superstructure and the widening of the bridge

will be carried out in three sections. The first and second sections will be devoted to removing the old projecting footways, fitting in place the two outer main girders with their bracing, and temporarily completing the reinforced concrete roadway. During this period, pedestrian traffic in both directions will be taken care of first by one and then by the other footway. In the third stage, the entire traffic (including vehicular and street car traffic) will be carried over the completed strips, and it will then be possible to replace the middle section of the bridge.

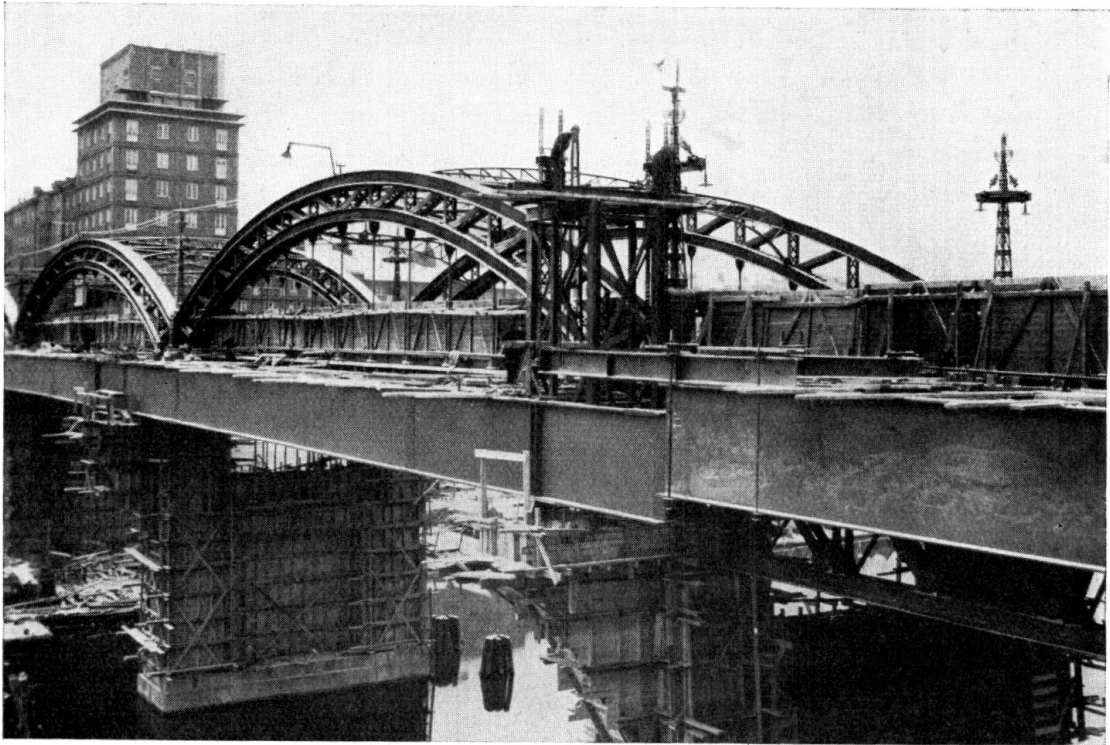

Fig. 18.

St. Erik's Bridge. Placing of new steel superstructure.

The old structure will be utilized as a support for the erection of the new steel superstructure. Subsequently, after the old steelwork has been removed, the new superstructure will be deflected into its final position on the piers with the aid of trestles on the concrete piers, hydraulic presses, and Gall chains (Fig. 18). The main and transverse girders are of St. 48 Structural Steel, and all other parts are made of St. 44 Steel. The total weight of the new steelwork is roughly 1100 tons, as compared with 1600 tons for the old bridge. The work of converting and rebuilding the bridge will be completed during the coming year.

Small Essinge Bridge (now building).

The reason for describing the comparatively small road bridge between Kungsholm and the island of Lilla Essingen is partly because the steelwork is to be welded throughout, and partly because of the special truss design. Formerly, this type of construction was used almost exclusively for timber structures, but

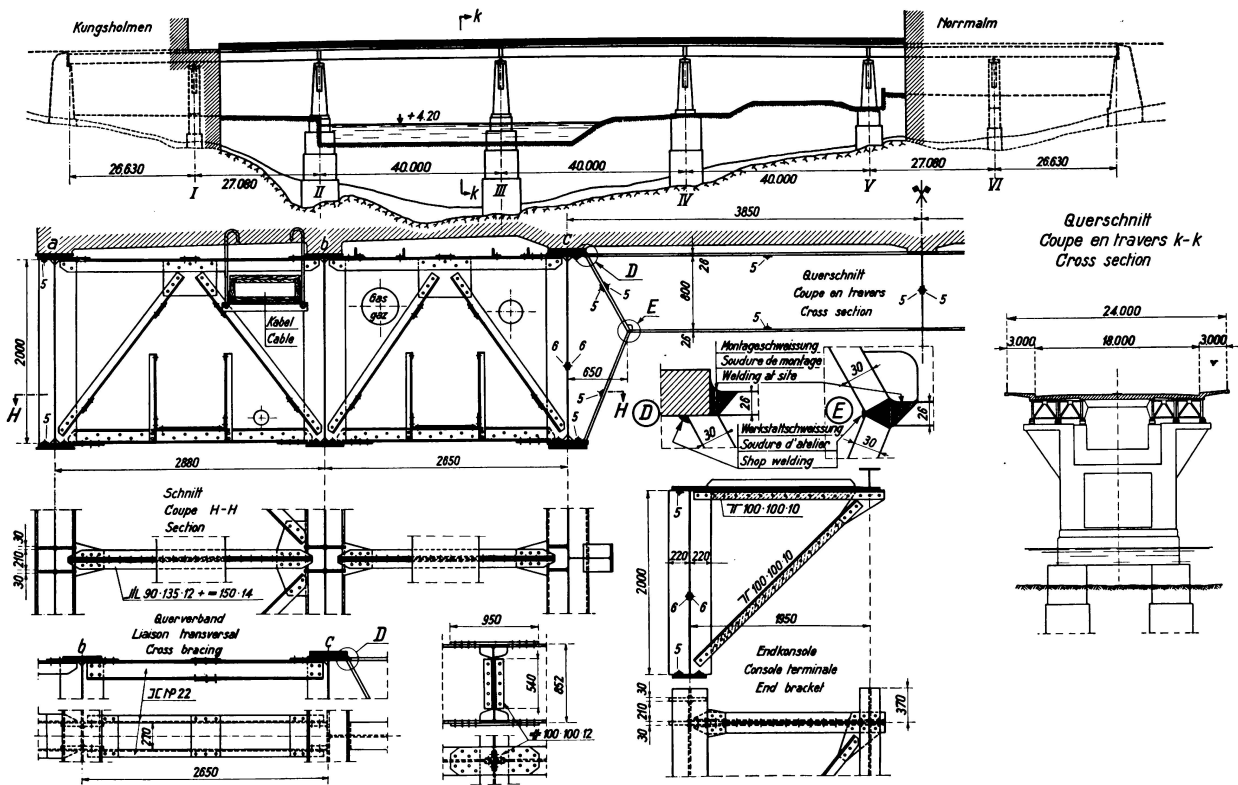

Fig. 16 and 17. St. Erik's Bridge. The bridge after reconstruction.

it also offers economic advantages when steel is used as the structural material. This construction will enable the main opening to be divided up into three bays with continuous girders, and obviate the expense of having intermediate piers in the water.

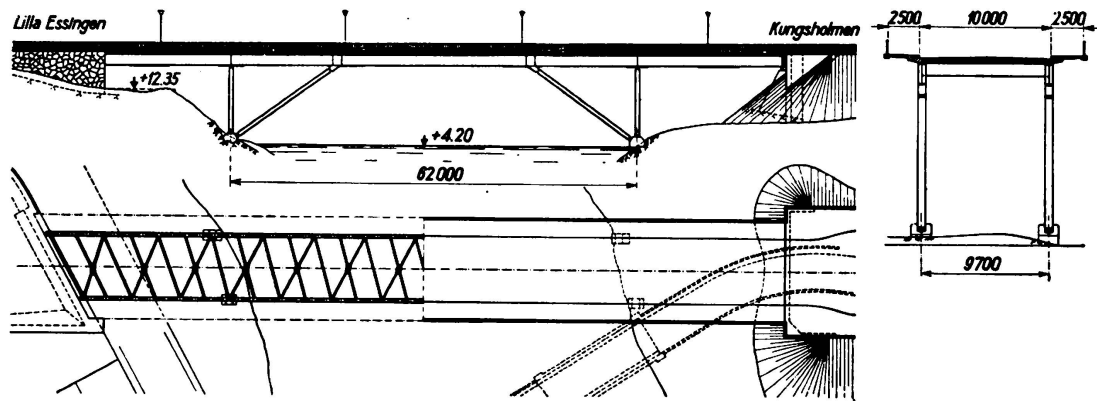

Fig. 19.

Little Essinge Bridge. General arrangement.

The bridge, of a total length of 109 m, consists of two continuous girders spaced 9.7 m apart, and intermediate transverse girders upon which the ferro-concrete roadway deck rests directly (Fig. 19). The river opening has a span of 62 m, and the width of the roadway is $2.5 + 10.0 + 2.5 = 15.0$ m. The total weight of the welded steel superstructure is roughly 240 tons.

Summary.

During the last few years, the following comparatively large steel bridges have been erected in Stockholm, in which welding has been extensively adopted.

1. *West Bridge*, a road bridge over Lake Mälaren in Stockholm. It consists of two arched main openings of 168 and 204 m span respectively, and connected viaducts of 12.9 m span. The total length of the bridge is 601.5 m, and the width of the roadway $2.5 + 19 + 2.5 = 24$ m. Total weight of superstructure, partly of St 52 Structural Steel and partly of St 44 Steel, approx. 7000 tons, of which about 2000 tons are welded.

2. *Pålsund Bridge*, another bridge in the same line of traffic as the West Bridge, consists of a 56 m double-hinged arch opening and connecting viaducts of 12 m span. Total length, 276.6 m; width, 24 m. Total weight of superstructure, partly of St 52 Steel and partly of St 44 Steel, about 1100 tons. Welded throughout.

3. *St. Eriks Bridge*, a road bridge being converted and rebuilt without interruption to traffic, the steel superstructure of which consists of continuous plate girders of $26.63 + 27.08 + 40.0 + 40.0 + 40.0 + 27.08 + 26.63 = 227.42$ m span. Width, 24 m. Total weight of the steel superstructure of St 48 Steel, about 1100 tons, welded throughout.

4. *Small Essinge Bridge*, a 15 m wide road bridge under construction, with a 62 m main opening, built on the truss system, and 109 m total length. Total weight of the steel superstructure of St 44 Steel, about 240 tons.