

Development, of structural steel-work

Autor(en): **Worch, G.**

Objektyp: **Article**

Zeitschrift: **IABSE congress report = Rapport du congrès AIPC = IVBH
Kongressbericht**

Band (Jahr): **2 (1936)**

PDF erstellt am: **21.07.2024**

Persistenter Link: <https://doi.org/10.5169/seals-3228>

Nutzungsbedingungen

Die ETH-Bibliothek ist Anbieterin der digitalisierten Zeitschriften. Sie besitzt keine Urheberrechte an den Inhalten der Zeitschriften. Die Rechte liegen in der Regel bei den Herausgebern.

Die auf der Plattform e-periodica veröffentlichten Dokumente stehen für nicht-kommerzielle Zwecke in Lehre und Forschung sowie für die private Nutzung frei zur Verfügung. Einzelne Dateien oder Ausdrucke aus diesem Angebot können zusammen mit diesen Nutzungsbedingungen und den korrekten Herkunftsbezeichnungen weitergegeben werden.

Das Veröffentlichen von Bildern in Print- und Online-Publikationen ist nur mit vorheriger Genehmigung der Rechteinhaber erlaubt. Die systematische Speicherung von Teilen des elektronischen Angebots auf anderen Servern bedarf ebenfalls des schriftlichen Einverständnisses der Rechteinhaber.

Haftungsausschluss

Alle Angaben erfolgen ohne Gewähr für Vollständigkeit oder Richtigkeit. Es wird keine Haftung übernommen für Schäden durch die Verwendung von Informationen aus diesem Online-Angebot oder durch das Fehlen von Informationen. Dies gilt auch für Inhalte Dritter, die über dieses Angebot zugänglich sind.

VII a 9

Development of Structural Steel-Work.

Entwicklungslinien im Stahlhochbau.

Le développement des constructions de charpentes métalliques.

Dr. Ing. G. Worch,

Professor a. d. Technischen Hochschule, München.

In considering structural steel work, various methods may be adopted. The mode of representation generally found in technical literature — particularly in text books — is to classify the structures in accordance with the static action of their members; consequently girder structures are treated by themselves, likewise arched structures, frames, etc.

In contrast to this, the structures considered in this report will be considered with reference to the purpose for which they were intended. The historical development can then be easily followed.

As a rule the buildings treated here are German ones; foreign buildings are mentioned only exceptionally to serve as comparison.

The descriptions are based mainly on details obtained from technical literature. The literary sources are always given; if particulars of a building have been given in several publications, only the most important one is mentioned.

Railway Station Halls.

Last year the German railway could celebrate its 100th anniversary. Within that period the size, weight and speed of the trains have increased enormously. This development, in so far as a continuous increase in size is concerned, was made also by the steel station halls only at the beginning.

Dimensions.

The older station halls consisted as a rule of simple trusses on fixed supports. The trusses are designed either as sickle-shaped lattice girders — Munich¹, erected 1876—82 or as arched plate girders with tie members for taking the horizontal thrust — Münster i. W.², Hanover³, erected 1878—80. The supports of these halls consist either of masonry or cast-iron. The spans are moderate (20—40 m).

But the first wide-spanned station halls (Fig. 1), whose lattice-work arches stretched over several platforms, very soon came into existence. Some of these

¹ *Jordan-Michel*: Die künstlerische Gestaltung von Eisenkonstruktionen 1913, 2nd Vol., p. 44 (The aesthetic side of steel constructions).

² *Jordan-Michel*: p. 48.

halls, arranged chronologically according to the period when erected, are mentioned in the following table.

Table 1: Wide-spanned halls.

Railway station hall	Erected	Length	Span	Height	Literature
Berlin, Schles. Statin	1881—82	207	54.4	19.0	Foerster ³ p. 662
Frankfurt on Main	1886—87	186	56.0	28.6	„ p. 759
Bremen	1888—89	131	59.3	28.4	Jordan-Michel ¹ p. 50
Cologne	1890—92	254	63.5	24.0	Foerster p. 770
Dresden	1895—98	174	59.0	30.0	„ p. 764
Hamburg	1902—04	173	73.0	35.0	„ p. 794

Beside these large halls there are very often smaller adjoining halls, for example in the stations at Cologne and Dresden. In some cases, several large halls are erected beside each other; for example, the main railway station at Frankfurt-on-Main has three equally large halls.

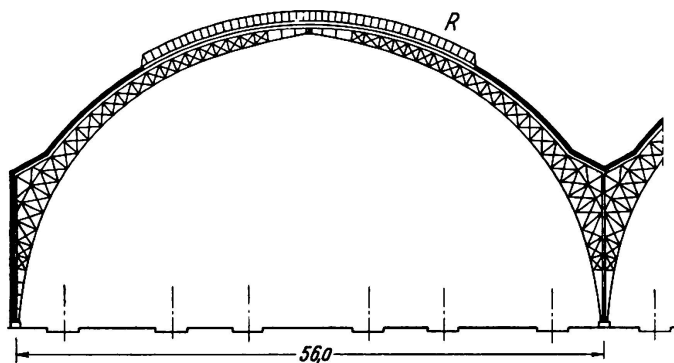

Fig. 1.
Main Railway Station
Frankfort on Main
R Skylights.

The lattice work trusses of these halls were as a rule arranged in pairs; every two trusses were united by members to form a space system. The distance between two trusses thus connected together amounts to 0.80 to 1.20 m.

These large wide-spanned railway station halls are undoubtedly very imposing in appearance; they also serve to give the arriving traveller his first impression of the town in which they stand. But, regarded from the practical point of view, they possess considerable drawbacks which became more and more evident in the course of time. Amongst these, in addition to the comparatively very high cost of building them, is the continual maintenance, which, because of the great dimensions of the halls and therefore also of the scaffolding, is extremely difficult and costly; for this reason it may very often be carried out less thoroughly than it should be.

Consequently, for a considerable number of years, the railway authorities have preferred to erect halls of medium and smaller spans, even at important and large railway stations.

In the course of time two types of halls — speaking very generally — have been developed:

- a) the small hall, stretching over one platform and two lines of rails, with a span of about 20 m;

³ Foerster: Die Eisenkonstruktionen des Ingenieur-Hochbaues (Steel in structural Engineering), 5th edition, 1924.

b) the medium-sized hall, with two platforms and 4 lines of rails within the hall, the span being about 40 m.

In the two following tables some small and medium-sized halls are given, arranged according to the date of their erection.

Table 2: Small halls.

Railway station hall	Erected	Length	Span	Height	Literature
Basle, Bad. Station	1911/12	305	24.0 resp. 20.0	11.5 resp. 11.0	Foerster p. 749
Karlsruhe	1912/13	—	21.5	13.0	„ p. 753
Oldenburg	1916	153	21.0	8.0	„ p. 754
Frankfurt o/O.	1926	178	19.35 resp. 20.75	9.47 resp. 9.76	Bautechn. 1926, p. 668
Halle o.S.	1934	103	22.75	8.8	„ 1935, p. 67
Düsseldorf	1934	—	20.5	8.3	{ „ 1931, p. 279
Duisburg	1934	—	19.7		{ „ 1935, p. 68

Table 3: Medium-sized halls.

Railway station hall	Erected	Length	Span	Height	Literature
Metz	1907—09	165	32.6 resp. 42.6	18.0 resp. 22.0	Foerster p. 785
Leipzig	1911—14	204	42.5 resp. 45.0	19.7	„ p. 777
Königsberg i. Pr.	1928—29	178	37.0 resp. 43.55	13.67 resp. 15.62	Bautechn. 1928, p. 659
Liegnitz	1929	120	35.5	19.3	Bauing. 1930, p. 445
Beuthen O.-S.	1929—30	141	39.2	13.1	„ 1930, p. 846

The two medium-sized halls at Metz and Leipzig have still lattice-work trusses; those of the hall at Metz being single trusses, whilst the ones at Leipzig are double. The other medium-sized halls mentioned in the table, as well as all the small halls mentioned, have plate trusses.

Naturally both small and medium-sized halls may occur in one and the same station. For example, the Friedrichstraße Station⁴, Berlin, has two halls beside each other, of which the small hall — for metropolitan trains — has a span of 19 m, whilst the other — for distant traffic — is a medium-sized hall with a span of 38.7 m.

In exceptional cases, large halls of great span are still built in modern times, especially when it is a question of replacing existing stations by new ones. As an example of this the new hall of the Schlesische Station⁵ Berlin, may be mentioned, which, with a span of 54.35 m and a height of 18.41 m, has nearly the same dimensions as the old hall. However, instead of the former lattice-work double trusses, single plate trusses are now used.

Forms of the halls.

Most of the earlier, wide-spanned halls — Frankfurt-on-Main, Bremen, Cologne, Dresden — are arch shaped, somewhat as shown in Fig. 1; the halls of the main station at Leipzig are also of this shape.

⁴ Bauingenieur 1925, p. 321.

⁵ Stahlbau 1931, p. 292.

For the more modern small halls, the arch form proved to be unsuitable, since it is impossible to make full use of the light-space of the hall. The truss form therefore changed over from arches to frames. At first, the arch shape was retained for the upper part of the frames. For example, in the halls of the Badische Station at Basle and the station at Karlsruhe the upper parts of the frames form a practically circular arch, whilst in the station halls at Oldenburg they are somewhat more elliptical in form.

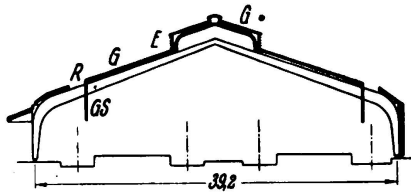

Fig. 2.

Railway Station Beuthen O.-S.
G glass, GS glass screen, E ventilation,
R smoke escape.

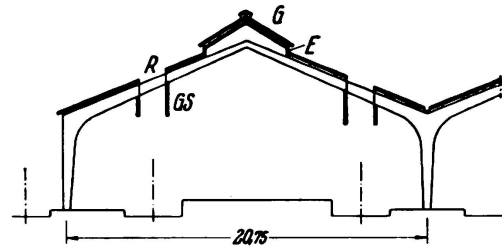

Fig. 3.

Railway Station Frankfort on the Oder
G glass, GS glass screen, E ventilation,
R smoke escape.

The arched form of the upper part of the frames makes it necessary for the roof covering to be uniformly curved or intermittently bent. Consequently the line of the upper part of the frame soon began to be of straight roof-shaped form. The same development from the round shape to a sharp bend is to be seen also in the design of the corners of the frames (cf. Figs. 2—4). Of great influence on this has also been particularly the adoption of modern welding methods in construction (for example, the hall at the railway station at Halle-on-the-Saale).

It is also not without interest to note that this frame form with the upper part bent to the shape of the roof has also been adopted in some earlier lattice-work type halls; an example of this is the main railway station at Hamburg.

The new welded halls of the stations at Düsseldorf (Fig. 5) and Duisburg also show a frame form, but with intermittently bent roofing.

Lighting and ventilating.

The older, wide-spanned railway station halls had as a rule transverse saddle-shaped skylights (Fig. 1). By lifting the caps of these skylights, and also by raising the roofing over the double trusses, ventilation was provided for.

In place of the saddle-shaped skylights longitudinal rows of windows were adopted. The railway station halls at Leipzig may be cited as an example; there the skylights are arranged in steps in order to facilitate ventilation.

It can be easily understood, and experience has also shown, that the skylights get dirty rather quickly immediately below the ventilating openings. A strip of opaque roofing was consequently arranged at these spots, as, for example, in the hall at Beuthen (Fig. 2).

The railway stations hitherto mentioned have large or medium-sized halls. In the small halls, the question of lighting and ventilating was at first solved in the same way; the Badische Station at Basle may be mentioned as an example. A

little later, corresponding to the example of the station halls at Ghent and Ostend⁶ a continuous slit was provided over the tracks, and the smoke escaped at once through it without reaching the interior of the hall. At the platform side, the slits are bordered by a hanging glass screen, which protects travellers from any obliquely falling rain. One of the first German stations of this type is at Oldenburg.

Generally such a screen is arranged only along one side of the smoke slit, but in the station hall at Frankfort-on-Oder (Fig. 3) there are two to each slit.

A combination of the two types of ventilation is found in the medium-sized station at Beuthen (Fig. 2). The two outer tracks are ventilated by smoke slits, whilst a lantern type of superstructure is provided for the inner tracks.

Inclined glass surfaces have the drawback that they are easily rendered obscure by a heavy snowfall, and the panes are liable to get broken; experience has shown also that they become dirty much sooner than vertical skylights. The trend of development in all structures is to use exclusively vertical glass surfaces. The recent station halls at Halle on the Saale (Fig. 4), Düsseldorf (Fig. 5) and Duisburg have consequently only vertical glass surfaces.

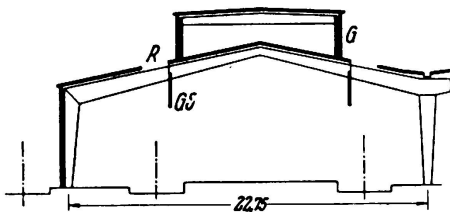

Fig. 4.

Railway Station Halle on the Saale
G glass, GS glass screen, R smoke escape.

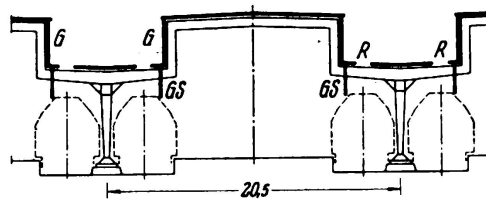

Fig. 5.

Main Railway Station Düsseldorf
G glass, GS glass screen, R smoke escape.

Of particular interest in this connection is a design which was at the time proposed for the Friedrichstrasse station in Berlin⁴ (Fig. 6). The truss forms are certainly similar to those in the halls at Düsseldorf and Duisburg, but the position of the trusses with respect to the platforms, and also the solution of the question of lighting and ventilating, show essential differences. From this single comparison, the trend of development of railway station halls can already be seen clearly.

Halls for electric railways.

With the introduction of electrification, the point of view for the design of station halls has changed, the question of ventilation now recedes into the background.

The new halls of the Berlin metropolitan and circular railway, which is worked exclusively by electricity, cover together only two tracks with one platform situated between them; they belong therefore to the group of small railway stations.

⁶ Förster: p. 734.

Table 4: Halls of the Berlin metropolitan and circular railway.

Station	Erected	Length	Span	Height	Literature
Westkreuz ⁷	1928	158	21.6	—	Stahlbau 1930, p. 150
Janowitzbrücke	1932	142	14.0 to 18.0	5.35 and 8.25	P-Träger 1932, p. 77
Schöneberg	1933	160	19.1 to 23.6	9.1	Stahlbau 1933, p. 105

The cross-sections of these three halls are shown in Figs. 7—9.

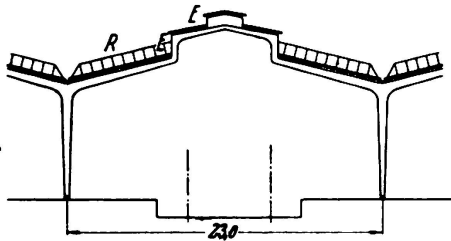

Fig. 6.

Railway Station Friedrichstraße, Berlin
(this proposal not executed)
E Ventilation, R Skylights.

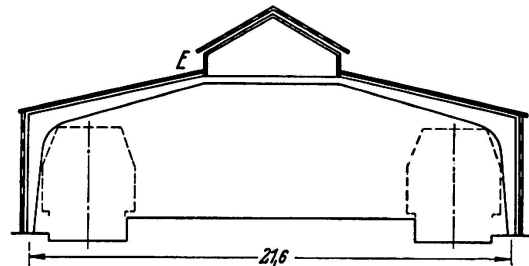

Fig. 7.

Railway Station Westkreuz, Berlin
E Ventilation.

The usual construction of such halls is plate frames with the upper part having a slight rise, as in the Westkreuz and Schöneberg stations. The adoption of the cross-section of the hall at Düsseldorf station when building the Janowitzbrücke station will certainly remain an exception, since the reentrant corners, as long as there are not several halls adjacent to each other, are justified mainly by the necessity of leading the smoke away quickly.

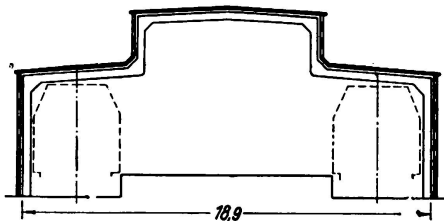

Fig. 8.

Railway Station Janowitzbrücke, Berlin.

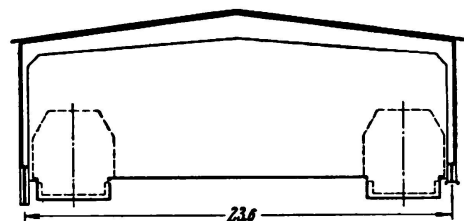

Fig. 9.

Railway Station Schöneberg, Berlin (section).

The hall of the Westkreuz station is lighted through the glazed side walls and, since the eaves lie only a little above the light-space profile, also through a glazed superstructure running in the longitudinal direction of the hall. The halls of the

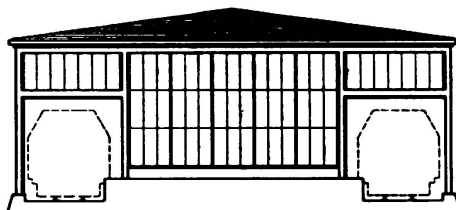

Fig. 10.

Railway Station, Schöneberg, Berlin
(Gable end).

Janowitzbrücke and Schöneberg stations have only vertical glass surfaces. In addition, in the Schöneberg station the side walls are carried up as high that the light in the hall is ample, even when the trains come in.

⁷ In publications this station is also designated „Ausstellung“.

For ventilating, slits in the walls or below the lantern on the roof, adjustable swinging sections in the glass windows prove sufficient.

At the ends, the halls can be closed if necessary down to the top of the train profile. As an example of this, Fig. 10 shows the gable wall of the Schöneberg station, which is glazed all over.

Exhibition and Sample Fair Halls.

The development of exhibition halls has been very variable. This is easily understood when it is considered that the requirements demanded from exhibition and sample fair halls may differ to an extraordinary degree. In addition, a number of other factors come into consideration, as, for example, the area of the site available, the amount of money which can be spent on the buildings, etc.; these factors have really nothing to do with the construction of the hall as such, but they nevertheless exert a considerable influence on the whole planning of the structures.

Dimensions.

In the same period as the wide-spanned railway station halls at Frankfurt-on-Main, Bremen, etc., came the large machinery hall of the Paris International Exhibition in 1889, which, with its three-hinged arches in iron of 111 m span, exceeded by a considerable degree any hall that had hitherto been erected. Also at the Chicago International Exhibition of 1892, the central hall was also erected with three-hinged arches, the span being about the same as that in the Paris exhibition, but the height somewhat greater.

Just as in the case of the railway station halls, this period of giant structures was very soon followed by a certain moderation. For exhibitions which last only a limited time, the buildings are often chosen intentionally of such dimensions that the halls can be adopted for other purposes after the close of the exhibition. A good example of this is the machinery hall⁹ of the International Building Exhibition at Leipzig in 1913, which, after the exhibition was over, was taken down and re-erected at Kiel as a workshop hall.

Among permanent structures is the domed building of the exhibition hall¹⁰ erected in 1908 at Frankfurt-on-Main. The middle part, which has a floor area of 67×54 m and is elliptical in plan, is bounded by two rectangular side halls of 49×29 m area. The whole hall is free from inner supports. In this connection the German machinery hall of the Brussels International Exhibition in 1910¹¹ should be mentioned. Even if the span of this three-bay hall with a total width of 40 m should appear very modest in comparison with the large halls first mentioned, the really great height of the structure relatively to the span is very striking; in the middle of the hall the clear height is 22 m.

The permanent exhibition and sample fair halls erected in Germany since the war can be divided roughly into two large groups:

- a) the large halls, which span the whole space without any inner supports. In this group are also to be placed the halls with several bays, where the span of the middle bay is a multiple of the spans of the side bays.

⁹ Bauingenieur, 1924, p. 745.

¹⁰ Stahlbau, 1928, p. 221.

¹¹ Jordan-Michel: 2nd Vol., p. 66.

In the following table are given the dimensions of some structures falling in this group.

Table 5: Large halls.

Hall	Erected	Span	Length	Height	Literature
Ausstellungshalle I on the Kaiserdamm, Berlin	1914	49.8	225	20.4	ZdVDI 1915, p. 45
Ausstellungshalle II on the Kaiserdamm, Berlin	1924/25	47.0	146	20.45	{ Deutsche Bauzeitg. 1925 Design and construction, p. 137
Sample Fair Hall 7, Leipzig		1928	97.8	139	
Sample Fair Hall 19, Leipzig	1928	60.0	140	19.5	Stahlbau 1928, p. 161
Sample Fair Hall 20, Leipzig	1929	50.0	80	18.3	Bautechn. 1930, p. 347
Deutschland Hall, Berlin	1935	58.2	95	28.5	Deutsche Bauztg. 1935, p. 1003
Sample Fair Halls on the Masurenallee, Berlin	1936	23.3	45	35.0	{ Nothing yet published
		41.15	97	18.0	

For the sample fair hall in the Masurenallee in Berlin, the first row of figures refer to the middle hall, whilst the figures in the second row give the dimensions of the side exhibition halls.

- b) In the second group have to be placed halls where the span has to be comparatively small because of the necessity of providing an overhead crane. As a rule these halls have three bays, a high middle bay being bounded on both sides by bays which are lower and in some cases also narrower.

Table 6: Small halls.

Hall	Erected	Middle bay		Side bays		Length	Literature
		Span	Height	Span	Height		
Sample Fair Hall 8, Leipzig	1924	21.88	15.6	11.06	8.0	195	Bautechn. 1925, p. 4
Sample Fair Hall 9, Leipzig	1924	19.5	19.59	19.5	13.1	173	Bautechn. 1924, p. 490
Nordic Sample Fair, Kiel	1925	28.0	15.6	7.0	5.2	171	Bautechn. 1926, p. 33
Sample Fair Hall 21, Leipzig	1925/26	24.0	18.1	10.0	8.0	155	Bauingenieur 1927, p. 1

Truss forms and lighting.

To a far greater extent than in all other halls, particular importance is attached in exhibition and sample fair halls to good and uniform lighting. The form given to the trusses is consequently often conditioned by the lighting requirements.

In the machinery hall of the Iba 1913, curved roughglass panes are provided, where the frame uprights connect to the ridge, for lighting the middle bay. Quite similar in form, as also in dimensions, is the same fair hall 21 at Leipzig (Fig. 11). The middle bay is also lighted through rows of windows in the walls above the side bays; here, however, the glass surfaces are absolutely vertical. Also the sample fair hall 9 at Leipzig has rows of vertical windows under the eaves of the middle bay.

The main hall for the Nordic Sample Fair at Kiel (Fig. 12) has a stepped roof with rows of vertical windows in the separate risers. In contrast to this construction, in which the woodwork of the roof is strung on the steel three-hinged frames, in the sample fair hall 8 at Leipzig (Fig. 13) particular importance was laid on the

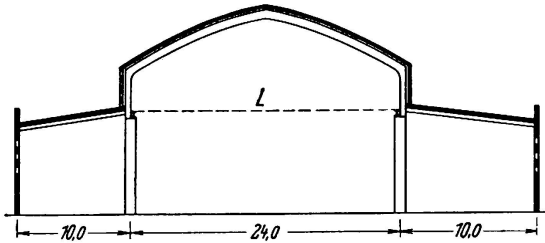

Fig. 11.
Market hall 21, Leipzig
L travelling crane 20 t capacity.

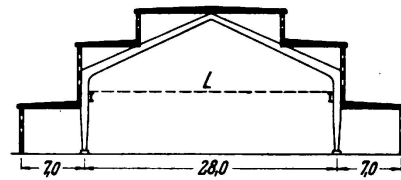

Fig. 12.
Market hall, Nordic Fair, Kiel
L travelling crane.

roof covering, as seen from the interior of the hall, running as far as possible in line with the supporting structure. There had to be no space anywhere between the supporting and the supported parts.

The smaller halls mentioned above have all been constructed with plate trusses, but in the wide-spanned halls lattice-work predominates.

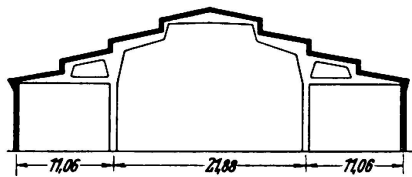

Fig. 13.
Exhibition hall 8, Leipzig Fair, Leipzig
Provisions made for future crane.

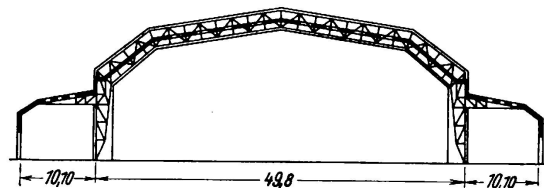

Fig. 14.
Exhibition hall I on Kaiserdamm, Berlin.

At the desire of the jury, the lattice-work construction of exhibition hall 1 on the Kaiserdamm in Berlin (Fig. 14) was completely encased. In order to avoid having a double ceiling, the roof covering is located at about half the height of the trusses. The part of the lattice-work trusses projecting outwards is covered with wood casing and asphalted sheeting; the inner part of the trusses has a Rabitz covering. The skylights are arranged in the middle part of the trusses.

Fairly similar, both in dimensions and also in the shape of the trusses, but executed fully plated, is hall II on the Kaiserdamm in Berlin (Fig. 15). The three-hinged trusses are uniformly curved and are left quite uncovered. The skylights are on the outer parts of the roof of the middle bay, where the slope is greatest. By means of the gallery running round the side bays, the available exhibition space is considerably increased.

The construction of hall 20 of the Leipzig Building Fair (Fig. 16) is also plated. The trusses are riveted sheet-metal girders, resting fixed at both ends on fixed supports, which are of lattice-work type in the lower part. The hall is lighted by vertical glass surfaces, 12 m high, in the side walls.

As the day-light intensity curve¹² shows, in such wide halls with windows only in the side walls, the brightness of the light in the middle of the hall is only about half of what it is near the windows. In hall 19 at Leipzig (Fig. 17), which is about

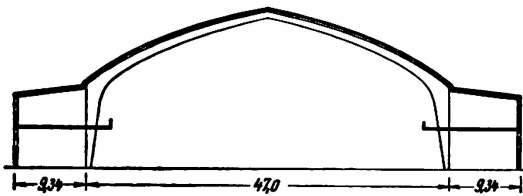

Fig. 15.

Exhibition hall II on Kaiserdamm, Berlin.

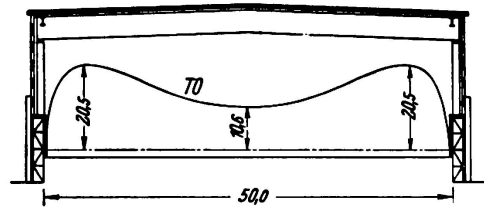

Fig. 16.

Exhibition hall 20, Leipzig Fair, Leipzig
TO Curve of daylight ratio.

10 m wider, an endeavour was made to distribute the light more uniformly, and yet to manage only with vertical skylights; by adopting an arrangement of glass surfaces as shown in Fig. 18; this will require no further explanation.

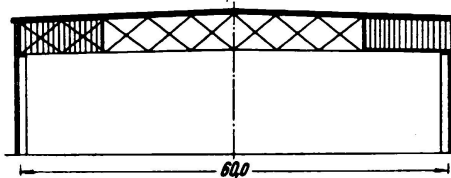

Fig. 17.

Exhibition hall 19, Leipzig Fair, Leipzig
(section).

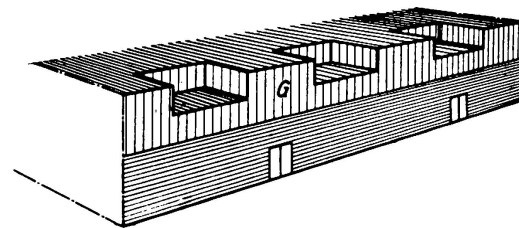

Fig. 18.

Exhibition hall 19, Leipzig Fair, Leipzig
(side view)
G glass.

Sample fair hall 7 at Leipzig (Fig. 19) has two-hinged framed lattice-work trusses with saddle-shaped skylight. The upper members of the trusses form, as shown in Fig. 20, the ridge of this skylight, whilst the two inwardly inclined glass

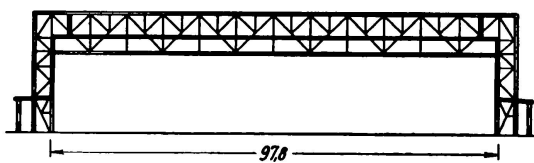

Fig. 19.

Exhibition hall 7 Leipzig Fair, Leipzig.

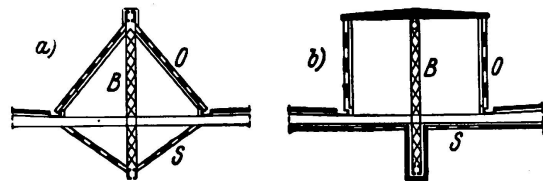

Fig. 20.

Design of skylights
B truss, O skylight, S dust screen.

surfaces of the dust roof come together at the lower members of the trusses. Naturally, vertical skylights may also be adopted here, as shown for example in Fig. 20b; such a construction has been proposed for, amongst others, a congress and exhibition hall at Hamburg.¹³

¹² Determined according to the Burchard light-measuring system. Cf. *Maier-Leibnitz: Der Industriebau* 1932, pp. 77ff.

¹³ *Stahlbau* 1935, p. 40.

In the Deutschland Hall in Berlin, only the roof construction over the middle part, which measures 95×58.2 m, is constructed of steel; the walls supporting it are in masonry. As shown by Fig. 21, the trusses, which are designed as single lattice-work girders of 58.2 m span, are supported at each end on the roof beams, which are Gerber lattice-work girders passing along the whole length of 95 m. Transverse to the trusses run lattice-work purlins — also designed as Gerber girders; they support the rafters of the two-ply waterproof roofing and also the protecting roof, below, which is made of asbestos sheets.

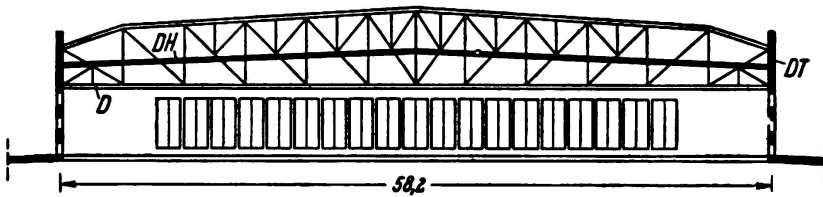

Fig. 21.

Roof construction of Deutschlandhalle, Berlin
DH roof cover, DT roof girder, D suspended ceiling.

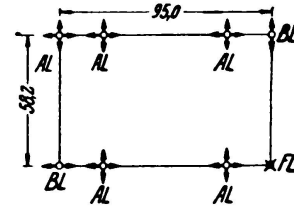

Fig. 22.

Supports of roof construction of Deutschlandhalle, Berlin
FL fixed bearing. BL bearing movable in direction of arrows, AL bearing movable in all directions

In such large connected roof structures, particularly when the supporting structure is of a different material, provision must be made to allow for mutual expansion. How this has been solved quite simply in the present case is shown diagrammatically in Fig. 22.

The Deutschland Hall serves not only as an exhibition hall; it is used particularly for large meetings, sporting events, etc. For lighting, it was consequently found sufficient to provide a row of windows running round below the steel roof.

The sample fair halls in the Masurenallee in Berlin, consist, as already mentioned, of two lateral exhibition halls and a middle hall.

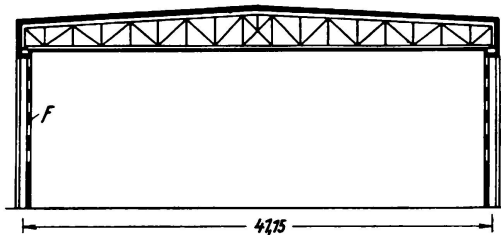

Fig. 23.

Fair hall at Masurenallee, Berlin (side view)
F glazing

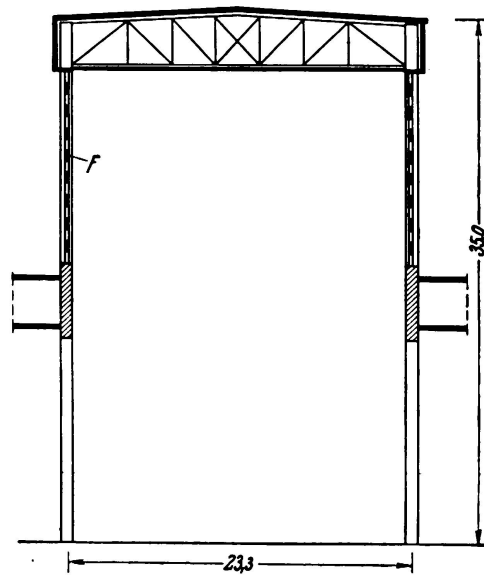

Fig. 24.

Fair hall at Masurenallee, Berlin
(hall of honours)
F glazing.

The side halls (Fig. 23) have lattice-work trusses with ceiling suspended below; the plate supports are fixed at the foot. The lighting is from windows about 10 m high, in the side walls.

In contrast to the other structures, the middle hall (Fig. 24) is remarkable for its great height, 35 m. The trusses here again are normal lattice-work trusses, which are also hidden from view by a ceiling suspended below them. The walls too have again windows of large area. For this reason, of course, the problem of arranging for wind pressure was rendered very difficult; a horizontal rectangular frame, closed on all sides, is provided at the height of the lower member of the trusses; this frame is supported in a frame fixed at the bottom in each of the four fronts.

Airship Halls.

The development of airship halls is conditioned by the development in airship construction. The dimensions of some airships are given in the following table.

Table 7: Dimensions of airships.

System	Designation	Frist trip	Length	Diameter	Literature
Zeppelin	LZ 1	1900	128	11.7	Moedebeck ¹⁴ p. 732
	LZ 11	1912	148	14.0	
	LZ 62	1916	198	23.9	
	LZ 120	1919	120.8	18.7	Engberding ¹⁵ p. 160
	LZ 126 (Los Angeles)	1924	200	27.64	
	LZ 127 (Graf Zeppelin)	1928	235	30.5	
	LZ 129 (Hindenburg)	1936	245	41.2	
Schütte-Lanz	SL 1	1911	131	18.4	Moedebeck ¹⁴ p. 755
	SL 15	1916	174	20.1	
	SL 24	1918	232	25.4	
Parseval	PL 1	1909	60	9.4	Moedebeck ¹⁴ p. 786
	PL 25	1915	110	16.4	
	PL 27	1916	160	19.6	

Shape and dimensions of halls.

All the airship halls have the same ground plan, a long rectangle. For reasons of economy, halls with circular or star-shaped plan¹⁶ have not passed beyond the suggestion stage.

In the halls hitherto built, a distinction must be made between those intended for one airship, and those for taking two airships. In the early days when airships were comparatively small, a double hall was often chosen, principally from reasons of economy. An objection to this type was, however, meanwhile found: the airships when entering or leaving the hall, especially in a high wind, got in each other's way. In addition, if any accident such as an explosion occurred, there was the risk of two airships being damaged or even destroyed. With the present dimen-

¹⁴ Moedebeck: Taschenbuch für Flugtechniker und Luftschiffer, 4th edition, 1923.

¹⁵ Engberding: Luftschiiff und Luftschiiffahrt 1928.

¹⁶ Eisenbau 1910, p. 228.

sions of airships, it is probable that only halls for one airship will come into question in future.

Table 8: Halls for one airship.

Airship hall	Erected	Length	Width inside	Height	Literature
Tegel		100	25	25	Eisenbau 1910, p. 229
Frankfurt	1911	160	30	24	Stahlbau 1930, p. 61
Seddin		184	35	28	Engberding, p. 212
Friedrichshafen	1929	250	50	46	Stahlbau 1930, p. 61
Rhein-Main	1935	281	52	51	P-Träger 1936, p. 2
Rio de Janeiro	1935	270	50	50	Stahlbau 1936, p. 88

Table 9: Double airship halls.

Airship hall	Erected	Length	Width inside	Height	Literature
Hamburg	1912	160	45	26	ZdVDI 1912, p. 1299
Potsdam	1912	172	50	25	ZdVDI 1913, p. 681
Leipzig	1913	184	60	25	Eisenbau 1913, p. 369
Seddin	1915/16	242	60	35	Stahlbau 1930, p. 61
Nordholz	1916	260	75	38	Stahlbau 1929, p. 251
Ahlhorn	1916/17	260	75	36	Stahlbau 1930, p. 61

The two new halls in North America are of very large dimensions, as can be seen from Table 10.

Table 10: New American halls.

Airship hall	Erected	Length	Width	Height	Literature
Akron	1929	358	99	55	Stahlbau 1930, p. 68
Sunnyvale	1932	341	94	59	Stahlbau 1933, p. 7

The trusses of the airship halls have hitherto always been of the lattice-work type. The preference for plate construction, which has been displayed in all other branches of steel structural work for quite a number of years, has hitherto not been considered for airship halls.

Fig. 25 shows the cross-section of the Tegel hall; statically, it is a two-hinged arch with raised footing. The recent halls are as a rule designed or statically determinate three-hinged arches; in order to reduce the stresses in the bars, the foot hinges are here also generally raised. Fig. 26 shows the cross-section of the Friedrichshafen hall; the halls at Rhein-Main and Rio de Janeiro are of similar design.

In the two American halls given in Table 10, the cross-section has been chosen parabolic; tests made on models in a wind tunnel showed this form to be suitable.

From the point of view of design, the three rotatable airship halls¹⁷ are very interesting; they are intended to facilitate the arrival and departure of the airships by being turned in the direction of the prevailing wind. Because of the high cost of construction, and also because of the improved landing facilities for airships (mooring masts¹⁸, etc.), this type of construction was soon abandoned.

¹⁷ Deutsche Bauzeitung 1914, p. 146; Bauing. 1922, p. 584.

¹⁸ Cf., for example, Z.d.V.D.I. 1936, p. 400.

Lighting and ventilating.

The hall at Friedrichshafen¹⁹, erected in 1909 for building airships, has saddle-shaped skylights extending over the whole hall. The later halls have all continuous rows of windows in the roof along the length of the hall, and also large windows in the walls.

The lighting surfaces of the new American airship halls are extremely small, since according to American opinion all work must in any case be done with artificial light, because the huge hull of the airship shuts out all daylight.

Great importance is attached to efficient ventilation, because of the gas filling of the airships. Generally a part of the windows is arranged to be opened; in addition ventilating valves, and special ventilating pans, are provided in the roof.

Doors.

The doors of airship halls have to conform to special requirements. When open, they must leave the cross-section of the hall perfectly free; also, in spite of their large dimensions, they must be capable of being opened and closed easily and without requiring any great force, even if there is a certain wind pressure.

As first constructed, the doors were of the ordinary hinged type, shown in Fig. 27a (airship hall Frankfurt, 1911; Baden Oos).²⁰ Very often double sliding doors, as in Fig. 27b, were used. Here two arrangements have to be distinguished. In one, the upper and also the lower rails for the door may project out beyond the sides (for example, airship halls Tegel, Ahlhorn and No dholz); this necessitates, of course, a special supporting structure for the upper rails. In the other arrangement, only the lower door rails project outwards beyond the sides, whilst the upper rails extend only over the width of the hall; the doors must then be designed as so-called "three-point" doors.

A combination of hinged and sliding doors was used in the airship works hall, built at Friedrichshafen in 1909. With a hall about 50 m wide, ordinary hinged doors would have to be too large, so that each leaf was divided into two. As shown diagrammatically in Fig. 27c, the inner leaf (I) was first slid behind the outer leaf (II), and then both were swung round together.

The forms of doors shown in Figs. d and e need no explanation. They were proposed for the Friedrichshafen hall just mentioned, but were not made.

When the hinged doors (Fig. 27a) are open, they form a funnel-shaped extension to the hall, and it was at first thought that this would to a certain extent protect the airships from the wind when entering and leaving. Such an arrangement can also be obtained with sliding doors (Fig. 27f), the guide rails projecting beyond the hall being not obliquely to the axis of the hall (Barkhausen system). Naturally, here also both the lower and upper rails may project out from the side; but also the lower rails alone may project out (for example, the airship halls at Potsdam and Leipzig).

In practice, however, it was found that air eddying is easily caused, and this may considerably impede the entering and departure of the airships.²¹ Consequently an endeavour is now made to have the opened doors as close as possible to the

¹⁹ Eisenbau 1910, p. 99.

²⁰ Z.d.V.D.I. 1918, p. 681.

²¹ Z.d.V.D.I. 1915, p. 762.

side walls (Fig. 27g), in order to offer less resistance to the wind and thus be less likely to cause any disturbing eddying of the air. In the halls at Friedrichshafen 1929, Rhein-Main and Rio de Janeiro cylinder-segment doors were adopted; instead of these the American halls (Table 10) have hemispherical-segment doors.

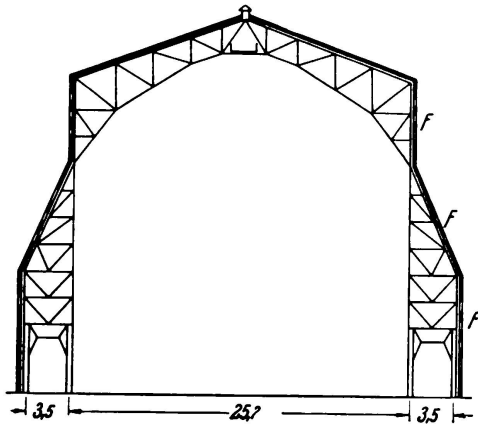

Fig. 25.
Airship Hall Tegel
F glazing

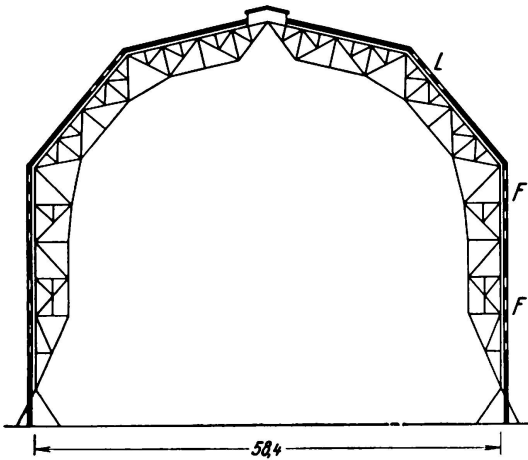

Fig. 26.
Airship Hall Friedrichshafen
L glazing, F window.

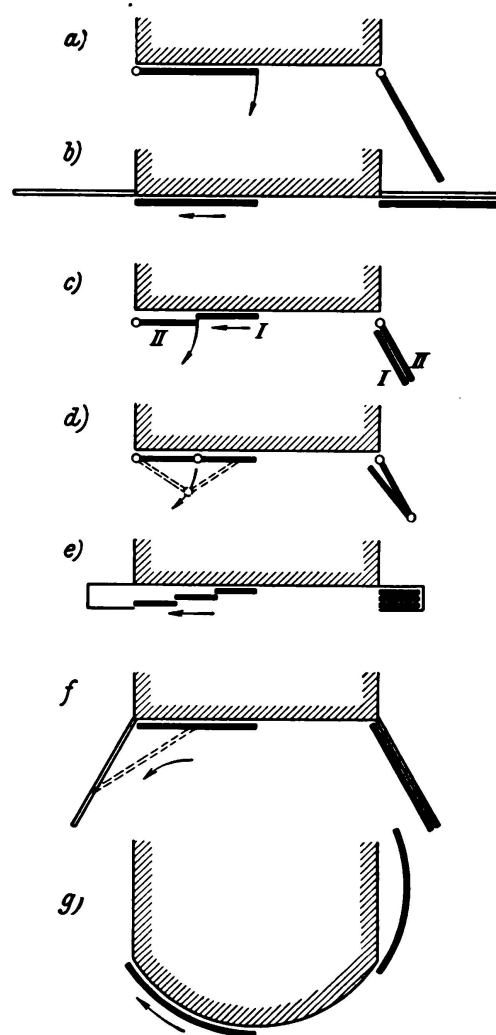

Fig. 27.
Arrangements of gates of airship hangars
(outline)
left half: gate closed, right half: gate open.

The majority of airship halls have a doorway at each end. Only a few halls have doors only at one end. Since a construction of recent date is found in the Rio de Janeiro hall, where the back end has only a small sliding door, which serves for taking the mooring mast in and out and also for ventilation.

Aeroplane Halls. (Hangars.)

The development of aeroplane halls shows, in general, no fundamental changes in the design of the halls, but merely an adaptation of the design to suit the steadily increasing dimensions of the aeroplanes. Particulars of a few aeroplanes are given in Table 11.

Table 11: Dimensions of aeroplanes.

Aeroplane	Built	Span of wings	Length	Height	Literature
Single-engine military planes					
Roland C II	1915	10.3	7.7	2.9	Moedebeck ¹⁴ p. 586
Junkers Cl I	1918	12.3	7.9	2.7	" "
Multi-engine military planes					
AEG G IV	1917	18.4	9.7	3.9	" p. 595
Staaken R VI	1917	42.2	22.5	6.5	" "
Naval planes					
Brandenburg CC	1917	9.3	8.5	3.3	" p. 602
Staaken L	1917/18	42.2	22.2	7.4	" "
Single-engine commercial planes					
Junkers	1919	14.8	9.5	3.4	" p. 612
Dornier C III	1920-21	17.0	9.5	2.5	" "
Multi-engine commercial planes					
Junkers Ju 52	im commis-	29.25	18.9	4.5	Shell-Flugzeug-
Heinkel He 70	sion at present	14.8	11.5	4.15	führer ²² p. 78 a. 75

The principal dimensions of a number of aeroplane halls can be seen from the following table.

Table 12: Dimensions of some aeroplane halls.

Aeroplane hall	Erected	Depth	Door opening		Type of door	Literature
			Width	Height		
Standardised military aeroplane hall	1914/18	22.2	22.08	4.7	Folding-sliding door	Stahlbau 1928, p. 86
Berlin-Tempelhof	1925	30.0	4 × 40.0	8.0	Folding door	Bauing. 1925, p. 839
Nietleben near Halle	1925	22.0	39.7	6.3	Sliding door	Stahlbau 1929, p. 28
Hamburg-Fuhlsbüttel	1925	30.0	2 × 30.0	6.0	Sliding door	Bautechn.1927, p.311
	1926	40.0	80.0	8.0		
Bremen		30.0	80.0	8.0	Sliding door	Bautechn.1927, p.443
Stettin	1927	35.2	52.6	9.0	Sliding door	Stahlbau 1928, p. 88
Schkeuditz near Halle	1927	30.0	2 × 60.48	10.0	Folding door	Stahlbau 1929, p. 28
Dortmund	1927	25.0	41.0	7.2	Folding door	Stahlbau 1928, p. 194
Travemünde	1927/28	61.0	60.6	12.0	Sliding door	Bautechn.1928, p.294
Kiel-Vossbrook		28.0	35.0	8.0	Folding door	Stahlbau 1929, p. 22
Munich	1928	70.0	2 × 31.0 a. 60.0	10.0	Folding door	Bautechn.1930, p.251
Brunswick	1928/29	30.0	2 × 50.0	9.5	Sliding door	Stahlbau 1930, p. 124
		30.0	3 × 30.3	6.5		
Breslau	1931/32	30.15	54.0	8.0	Folding door	Bautechn. 1933, p. 96

²² Published privately by the Rhenania-Ossag Mineralölwerke A.-G., Hamburg, 1935 edition.

At first, when the dimensions of the aeroplanes were small, the halls consisted of any desired number of small hall units about 20 to 22 m², arranged alongside each other; the front wall of each unit was formed by the doors.

Soon, however, the increasing wing span made it necessary to have wider entrance doors. As can be seen from Table 12, the width of the door openings in recent halls is from 30 to 80 m; in the majority of cases, it is between 40 and 60 m. The clear height of the doorways amounts to 6 m to a maximum of 10 m; the only greater height of doorway is in the hall at Travemünde, where hydroplanes have to be run in on carriages.

A standard construction for aeroplane halls is shown in Fig. 28. The door beam passes over the whole width of the hall — with or without intermediate supports. Transverse to this are the trusses, which rest at the front on the door beam and at the back on the steel framed wall. These trusses often project in front over the door beam and support the upper door rails.

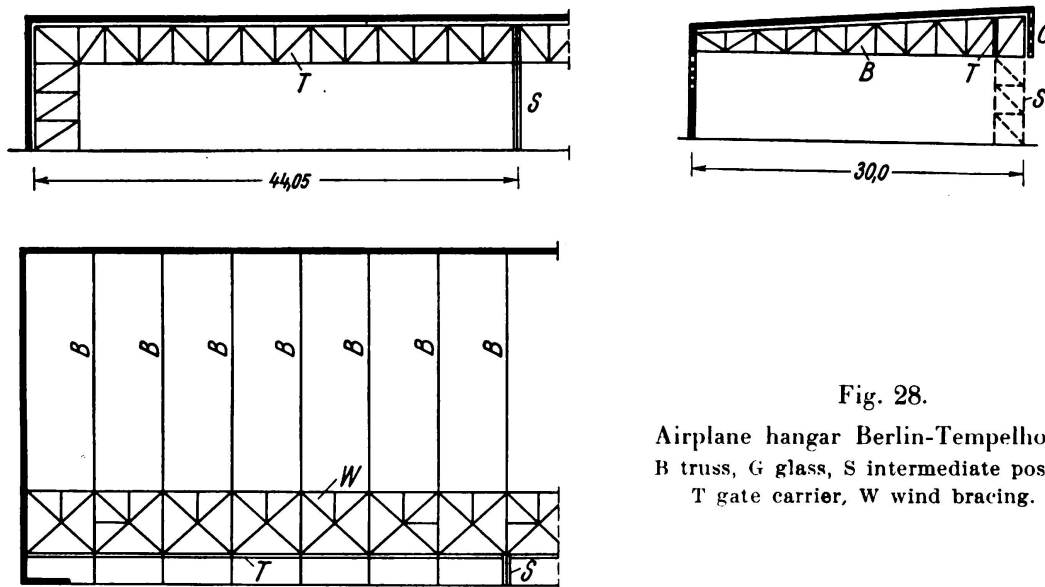

Fig. 28.

Airplane hangar Berlin-Tempelhof
B truss, G glass, S intermediate post,
T gate carrier, W wind bracing.

The supporting structure of all the above mentioned halls is of the lattice-framed type. The door beams are, as a rule, of uniform depth; only in wide-span beams (for example, in the halls at Hamburg and Bremen) the depth of the beams increases towards the middle.

Because of the great height of the door beams as compared with the height required for the trusses transverse to them, it was natural to make the roof slope down to the back. At the end of the war, the endeavour to make the halls look less like sheds led to some forms of cross-section with couple-close roof²³ being evolved; with the great height of the door beams, such lines do not come into consideration.

A construction differing from the usual shapes of the halls is to be seen in the aeroplane hall at Munich-Oberwiesefeld. As shown in Fig. 29, this hall has only one wall, whilst doors are arranged on the other three sides. This arrangement naturally makes another design of supporting structure necessary.

²³ Stahlbau 1928, p. 86.

In recent times the halls are as a rule lighted by rows of windows over the door and also in the rear wall, instead of by the saddle-shaped skylights formerly used. The glazing above the door may then be inclined; vertical windows are also often adopted (Fig. 28).

Particular consideration must be paid to the doors. Of the many systems proposed, sliding doors (Fig. 30a) and folding doors (Fig. 30b) have proved the most

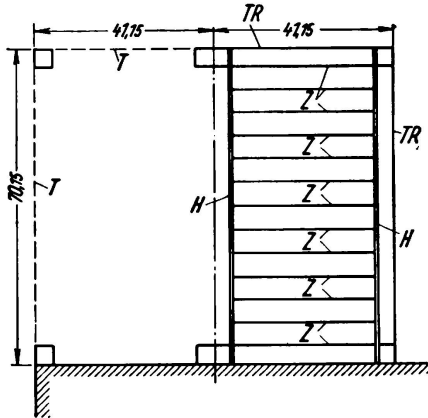

Fig. 29.

Airplane hangar Munich-Oberwiesenfeld (plan)
left half: arrangements of gates,
right half: roof construction.

T gate, TR gate carrier, H maintruss, Z intermediate truss.

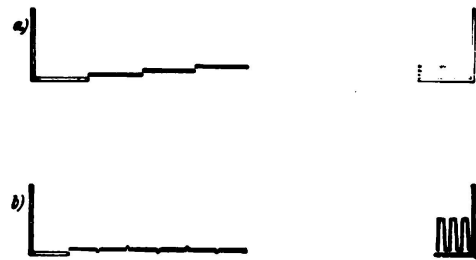

Fig. 30.

Arrangement of gates for airplane hangars
left half: gate closed, right half: gate open.

satisfactory and are exclusively adopted for recent halls. The door beams are already highly stressed by having to support the roof trusses; in order to avoid stressing them further, and also to be independent of their bending, the doors are generally supported below on running rails; the rails at the top merely serve to keep the doors always vertical.

Tramway and Motorbus Halls.

The great amount of room required for the maintenance, repairing and cleaning of tram cars and motorbusses makes it necessary, especially in large towns, to roof-over large spaces. The old existing carsheds, which were as a rule fairly small, have therefore generally made place for new large halls, particularly in the afterwar period.

Tramway Halls.

In tramway halls, the design of the structure is comparatively simple, since it is at once possible to support the roof by rows of pillars placed between the tracks. But, in order to lose as little space as possible, and also not to obstruct the view, the distance between the supports was chosen not too narrow. All new halls have a truss span of over 20 m.

The Dortmund tramway hall²⁴, built in 1926, has still lattice-work trusses. On the other hand, the hall built only a little later at Bochum²⁵ (Fig. 31 a) has already

²⁴ Stahlbau 1928, p. 208.

²⁵ Bautechn. 1931, p. 691.

plate trusses; as can be seen from the longitudinal section (Fig. 31b) the distance between the supports in the direction of the tracks is fairly considerable. Consequently, in the direction of the length of the hall, joists were first arranged over the supports and on them the trusses lie.

For lighting these two halls saddle-shaped skylights are used. As an example of a construction with a row of continuous windows the tramway hall, Müllerstrasse,

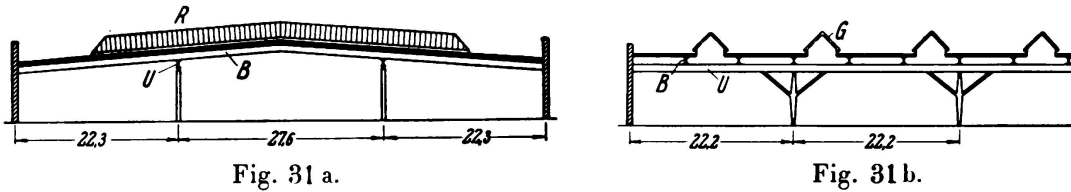

Fig. 31. Tram car shed, Bochum, a cross section, b longitudinal section
B frame, R skylights, U girder, G Glass.

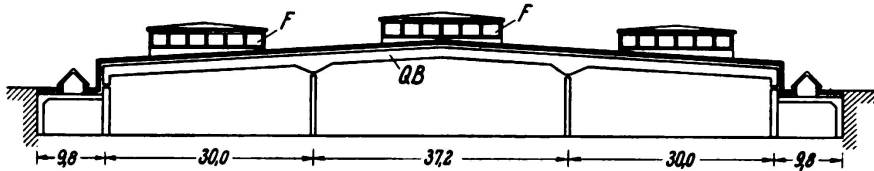

Fig. 32 a.

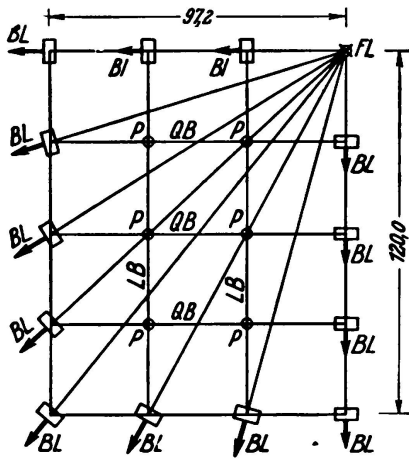

Fig. 32 b.

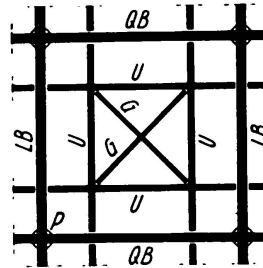

Fig. 32 c.

Fig. 32. Tram car station 16, Charlottenburg, a cross section, b plan and arrangements of bearings, c part plan
F skylights, G ridge girder, LB longitudinal truss, QB transverse frames, U beams, FL fixed bearing, BL bearing movable in direction of arrow, P hinged column.

Berlin²⁶, may be cited. The shape of the plated three-hinged arches is then suited to the skylights.

Very interesting from the point of view of design is the hall of tramway terminus 16 at Charlottenburg²⁷ (Fig. 32a). As can be seen from the plan (Fig. 32b), the hall has three transverse and two longitudinal trusses, connected at the points where they cross in order to prevent bending. Each of the spaces in the truss grating thus formed is in turn fitted with a grating of joists (cf. Fig. 32c), which supports the

²⁶ Bauing. 1928, p. 383.

²⁷ Stahlbau 1935, p. 1.

dome-shaped roof structure. The roof construction is supported on three sides on the small frames, and on the front on the gable wall. Further, rocking supports are arranged at the junction points of the truss grating. In order to prevent compression stresses, only one bearing is of the fixed type; all the other bearings are, as shown in Fig. 32b, movable radially. The whole of this large roof construction, measuring 97×120 m, can therefore expand and contract freely with fluctuations in temperature; measurements, taken during several years, show that the movements of the structure follow the fluctuations in temperature fairly closely.

Lighting is effected, apart from the small side frames exclusively through rows of vertical windows.

Motorbus Halls.

When deciding the span of the trusses and the distance between the supports in the tramway terminus 16 at Charlottenburg, consideration was also paid to the possibility that this building might some day be used as a motorbus hall. The conditions for motorbus halls are somewhat different: the effective area of the hall is reduced not only by the actual floor space covered by the supports; a much greater area must be deducted to allow a safe distance to be maintained between

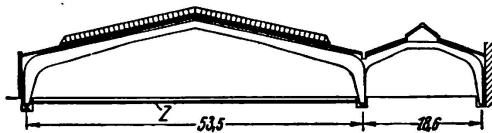

Fig. 33.

Motor-coach depot of the ABOAG Berlin,
Morsestr.-Helmholtzstr.
Z tie.

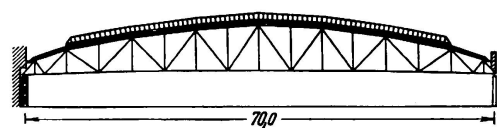

Fig. 34.

Motor-coach depot Treptow
of the ABOAG Berlin.

the moving vehicles and the supports. Another point to be considered is the great damage which may be caused to a vehicle, or even to the whole structure, in the event of a collision with one of the supports.

Consequently a hall erected solely for motorbusses has only very few inner supports, or generally none at all. The comparatively great cost of such buildings will soon be more than repaid by the extra floor space gained and above all by the spreading-up of the service²⁸.

Fig. 33 illustrates the hall built in 1925/26 in Berlin for the ABOAG in Berlin, Morsestrasse-Helmholtzstrasse²⁹, in which the plate trusses are provided with tension members below the floor. The motorbusses stand only in the large bay. The small bay is used solely as a washing room and for making light repairs. A similar structure, but with only one bay, is the motorbus hall of the Hamburg Hochbahn³⁰, which was erected in 1927.

The Berlin-Treptow hall³¹ (Fig. 34), because of the considerable span of 70 m, has parabolic lattice-work girders. Nevertheless, in the Berlin Wattstrasse hall³²,

²⁸ Bautechn. 1928, p. 315.

²⁹ Bauing. 1926, p. 959.

³⁰ Stahlbau 1928, p. 25.

³¹ Deutsche Bauzeitung 1931, Design and construction, p. 53.

³² Deutsche Bauzeitung 1931, Design and construction, p. 53.

erected a year later, a return was made to plate girder construction, although the span of 63 m is not much less. A lattice-work construction would have been cheaper, but plate was chosen for aesthetic reasons and also because of fire insurance requirements.

All the above-mentioned motorbus halls are provided with saddle-shaped skylights.

Steel Framed Buildings.

The home of steel framed buildings is America. Already in 1885 the first skyscraper was erected in Chicago. How rapid the development was, is best shown by the fact that in 1929 there were in the U.S.A. about 4800 buildings with more than 9 storeys³³. The highest steel framed building hitherto erected in the world is the Empire State Building³⁴, completed in 1931, which has 86 storeys and a total height of 381 m. Such high buildings are, however, no longer profitable, even under American conditions. The most recent investigations³⁵ have shown that skyscrapers with about 60 storeys show the best rentability in the U.S.A. The latest American buildings therefore, such as the Rockefeller Center in New York³⁶ endeavour no longer to create new records for height, but rather for the mass of the structure.

Also in Europe steel framed buildings were erected at an early date. As examples may be mentioned the Menier chocolate factory near Paris³⁷, built in 1871, and the Elbe store house at Magdeburg³⁸ built in 1890. However, such buildings remained for a long time quite exceptional in our part of the world. Until about the war, the usual form of steel building with several storeys was the so-called "girder construction": floor-girders, joists and inner supports were made of steel; the solid outer walls carried their own weight and also a share of the flooring. As a rule no investigations were made regarding wind pressure, since the buildings were mostly effectively stiffened by partition walls and floors. This simple method of construction proved no longer sufficient when, especially after the war, buildings became always higher and rooms as large as possible and of wide span without partition walls were demanded. Steel framed structures were then adopted also by us.

In steel framed buildings the steelwork takes the whole load; the only use of the walls is to enclose spaces. The material used for the walls must therefore be primarily a bad conductor of sound and heat; its strength on the other hand is quite a secondary matter.

This, of course, does not exclude the possibility of using a wall to support part of the load in cases where an ordinary brick wall is required, for example as a fire-proof wall. The masonry can also carry some of the load when, for example, a "wind target" (for taking wind pressure), which may be designed as vertical storey-frame or as lattice, is bricked in. In consequence of its greater stiffness, the wall prevents deformation of the steel construction; only when this rigidity has been overcome, i. e. when the wall cracks, will the steelwork take over the whole load.

³³ Stahlbau-Vorträge (Lectures on steel structures), published by the Deutscher Stahlbauverband, Berlin 1931, p. 29.

³⁴ Stahlbau 1932, p. 39.

³⁵ Bauing. 1935, p. 386.

³⁶ Bauing. 1933, p. 275 and Stahlbau, p. 198.

³⁷ Deutsche Bauzeitung 1932, p. 362.

³⁸ Stahlbau 1931, p. 186.

Ground plan of the buildings.

In the choice of the ground plan of a steel framed building, the designer has very seldom a free hand. First of all he is limited by the shape of the site available; then he has to consider whether the whole site should be built on, or whether — from considerations of lighting and ventilating — a part must be left free for a court. The steel framed buildings which have hitherto been constructed are consequently planned very diversely.

The simplest construction is, of course, possible in buildings where the plan is rectangular, or consists of several rectangles. Ground plans with walls making an acute angle with each other, or where the boundary lines are curved, generally entail difficulties in designing the steelwork.

In the following table, some shapes of ground plan, each with an actual example, are mentioned.

Table 13: Shapes of ground plan of steel framed buildings.

Shape of plan	Example	Fig.	Literature
Rectangle	Europahaus Leipzig	35 a	Stahlbau 1930, p. 181
Angle	Administrative buildings of the DHV, Hamburg	35 b	P-Träger 1930, p. 4
T	Sausagé factory of the Cooperative Society, Berlin	35 c	Stahlbau 1929, p. 241
I	Kathreiner Hochhaus, Berlin	35 d	Deutsche Bauztg. 1930, K. u. A., p. 85
Rectangle with inner courts	Deutsches Museum, Munich, Library Building	35 e	Stahlbau 1930, p. 109
Irregular srraightline boundaris	Rhenania-Ossag-Haus, Berlin	35 f	Stahlbau 1931, p. 43
Curved boundaries	Columbus-Haus, Berlin	35 g	Stahlbau 1931, p. 253
	Administrative buildings of the I.G.Farben, Frankfurt-on-Main	35 h	Stahlbau 1931, p. 1

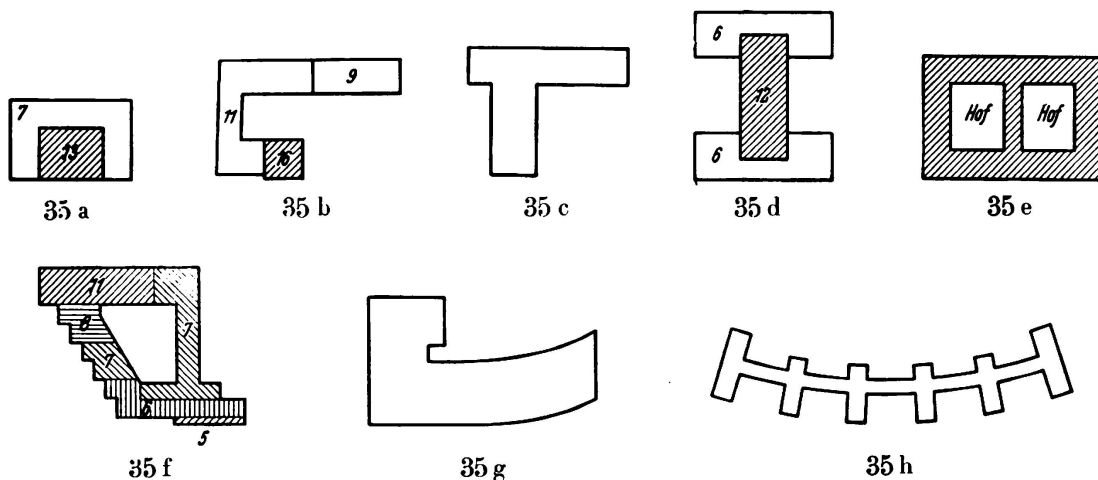

Fig. 35.

Arrangements in plan of steel skeleton constructions.

Elevations.

The maximum permissible height of a building is generally fixed by the local authorities; however, exceptions may be permitted in special cases.

The simplest section for a building is a rectangular one. In buildings in narrow streets or courts, the upper storeys must often be stepped back from considerations of lighting. An example of this is seen in Fig. 36, the section of business premises, "Samt und Seide", in Mannheim³⁹. The angle inclination α of this stepping should as a rule not exceed 67° .

The design of the structure is not quite so simple where the supports on the ground floor have to be set back, either to widen the pavement, or because of the arrangement of the shop windows. An example of this is shown in Fig. 37, a section through the Columbus-Haus in Berlin.

If only a part of the building is crowned with a tower, one speaks of a Turmhaus (tower house). For example, in the Europhaus in Leipzig, the tower, shown shaded on the plan in Fig. 35a, has 13 storeys above ground level, whilst the other

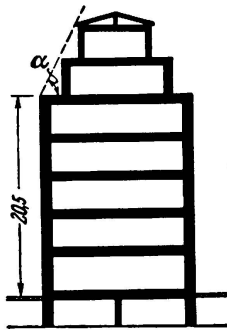

Fig. 36.

Office building "Samt und Seide",
Mannheim (cross section).

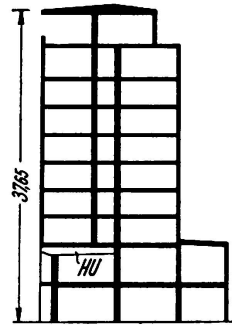

Fig. 37.

Columbus-building, Berlin (cross section)
HU main lintel.

part has only 7. The same applies to the buildings of which plans are given in Figs. 35b and d; here again the shaded part shows the location of the tower, whilst the numbers are the number of storeys above ground level.

Fig. 35b leads to the consideration of buildings of several different heights. As a further example may be mentioned the Rhenania-Ossag-Haus, Berlin, in which, as can be seen from the numbers in Fig. 35f, the number of storeys above ground level varies greatly.

An original type of building is also the spherical house⁴⁰ at Dresden, the only one as yet built.

Besides the section of a building and the number of storeys, the height of the rooms is also of interest. The following table gives these heights for a number of steel framed office buildings erected in recent years. It will be noticed that the tendency is to decrease these heights.

³⁹ Stahlbau 1928, p. 45.

⁴⁰ Stahlbau 1928, p. 130.

Table 14: Heights of rooms in office buildings.

Building	Erected	Ground floor	First floor	Other upper floors	Attic floor	Literature
I. G. Farben, Frankfurt-on-Main	1929	4.48	4.64	4.48—3.84	3.83	Stahlbau 1931, p. 1
Volksfürsorge, Hamburg	1929	4.2	4.2	4.2—3,3	—	Stahlbau 1931, p. 129
Europahaus, Leipzig	1929	4.45	3.55	3.55—3.4	2.78	Stahlbau 1930, p. 181
DHV, Hamburg	1929	3.3	3.5	3.45	2.55	P-Träger 1930, p. 4
Kathreiner Hochhaus Berlin	1929	4.55	3.6	3.4	2.8	Deutsche Bauzeitg. 1930 K. u. A., p. 85
Columbus-Haus, Berlin	1931	4.8	4.96	3.42	3.83	Stahlbau 1931, p. 253
Rhenania-Ossag-Haus, Berlin	1930—32	4.0	3.6	3,3	—	Stahlbau 1931, p. 43

Steel framed structures are lighted by separate windows or by rows of windows; they are arranged according to the usual rules⁴¹ for high buildings.

Wind bracing.

As already mentioned, as a rule no investigations were made regarding wind pressure, since the buildings were amply stiffened by the floors and partition walls. In more recent buildings, which have no or only a few partition walls, such simple procedure is no longer admissible. An obvious solution was to use frames instead of the partition walls; this led to buildings with vertical frames arranged side by side. In Fig. 38, which illustrates the plan of the business premises "Samt und Seide", in Mannheim³⁹, the frames are indicated by the thick lines.

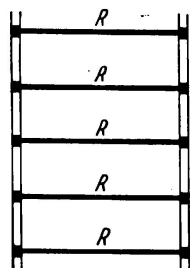

Fig. 38.

Office building "Samt und Seide",
Mannheim (plan)
R Frame.

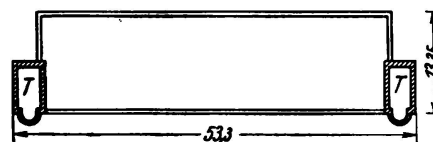

Fig. 39.

Postoffice building at Hochmeisterplatz,
Berlin (plan)
T staircase.

Instead of distributing the horizontal forces among a great number of frames, they may be concentrated on a few points, where they are taken up by special "wind bracing panels". Preferably these wind bracing panels are located in the gable walls or in the staircases; they may take the form of a solid wall, or lattice-work, or frames. As an example, Fig. 39 shows the plan of the postoffice building on the Hochmeisterplatz⁴², Berlin, in which the solid floors transmit all the wind forces

⁴¹ Cf., for example: *W. Büning and W. Arndt: Tageslicht im Hochbau (Daylighting in structural engineering)*, Berlin 1935.

⁴² *Stahlbau* 1933, p. 68.

to the masonry staircases. In buildings of complicated floor plan, such an arrangement will often not prove sufficient. As shown in Fig. 40, which represents the plan of the Rhenania-Ossag-Haus in Berlin, a number of columns are in such cases connected together by joists to form vertical frames.

Naturally the floors must also be capable of transmitting the wind forces to the "wind bracings." If a concrete pressure-layer is provided, special iron bars can easily be laid in it (for example, in Rhenania-Ossag-Haus, Berlin). In exceptional cases an arrangement of separate horizontal bracing may be necessary (example: Administrative buildings of the D.H.V., Hamburg).

A combination of steel framed and girder constructions may be adopted, in which the wind frames or bracing are provided to take only the wind forces acting on the highlying parts of the building; the wind pressure on the lower parts are taken by the solid outside walls. As an example, Fig. 41 shows the plan of the Werner Works in Berlin-Siemensstadt⁴³; in this case, frames and lattice-work targets take only the wind forces acting above the 6th storey.

To this group belong also structures — as, for example, the library building of the Deutsches Museum at Munich, — where the wind bracings take the wind pressure only while the building is being erected. When finally completed, the solid walls are made use of.

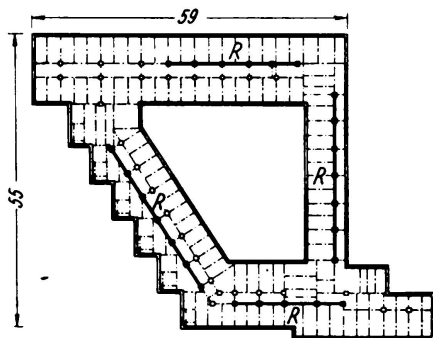

Fig. 40.
Rhenania-Ossag building, Berlin (plan)
R frame.

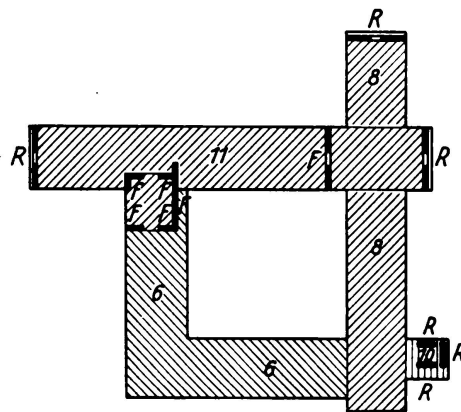

Fig. 41.
Wernerwerk, Berlin-Siemensstadt (plan)
F truss work, R frame.

Structural details.

The usual form of construction in steel framed buildings is in plate; I, IP and \square steel sections are adopted. Angle sections are also used exceptionally, for example in the State Records Office at Königsberg (Prussia)⁴⁴, where the uprights of the shelving are at the same time the uprights of the steel framework.

Because of the great stiffness required, wind bracings are frequently constructed of lattice-work. A steel framed structure, completely of lattice-work, is the Pressa-Turm⁴⁵ in Cologne. Also the ribs of the Europahaus in Leipzig — except in the basement and ground floor — are all in lattice-work; special rolled sections of swallow-tail shape were adopted.

⁴³ Stahlbau 1931, p. 39.

⁴⁴ Stahlbau 1933, p. 207.

⁴⁵ Stahlbau 1928, p. 73.

Finally, a combination of plate and lattice-work may be used, as for example in the administrative buildings of the D.H.V. in Hamburg. Here the uprights are in plate, whilst the horizontal members, laid in the parapets of the outside walls, are in lattice-work.

The development of special constructions is illustrated in the following Figs. 42 and 43; of these, Figs. 42d—e refer to details of the frame corners. Designs with corner plates, as for example used in the two-hinged frames of the new building "Samt und Seide" in Mannheim (Fig. 42a) or in the vertical storey frames of the Lochnerhaus⁴⁶ in Aachen (Fig. 42b), have recently been only rarely adopted. In their place come executions with feather bays and girder as frequently used, (for example in the library building of the Deutsches Museum in Munich, in the Werner Works in Berlin, in the administrative buildings of the Volksfürsorge in Hamburg, etc.). In the Rhenania-Ossag-Haus in Berlin, double bays, as in Fig. 42d, were adopted; through the tension straps, the joint could be kept comparatively small. A completely welded frame corner, as was used for example in the Haus der deutschen Erziehung⁴⁷ in Bayreuth, is illustrated in Fig. 42e.

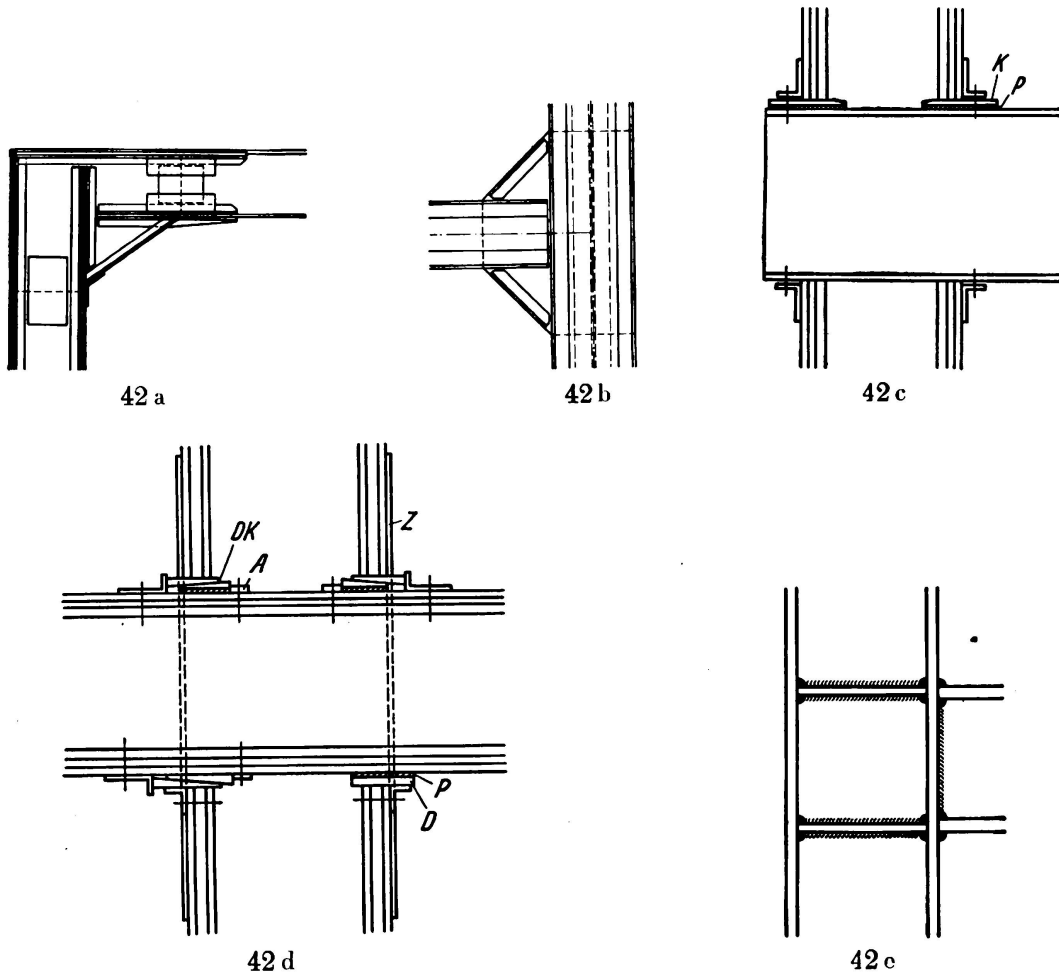

Fig. 42.

Details of frame corners

A rabbet, D pressure piece, DK folding wedges, K wedge, P adapter piece, Z tie.

⁴⁶ Deutsche Bauzeitung 1926, Design and construction, p. 41.

⁴⁷ Stahlbau 1936, p. 58.

A further development is also to be noted in the details of girder connections. The method by means of web angles or bearing plates has long been usual. Comparatively recently however, the junction has been as in Fig. 43a; tension strap and pressure pieces take the moments about the junction. A similar construction, but with welded tension strap, is shown in Fig. 43b⁴⁸. In order to have to make as few joints as possible on site, the tension strap is divided; only the V joint marked B has to be welded on site, the others being done in the workshops. Finally, a completely welded execution — patented by the Gutehoffnungshütte, Oberhausen — is illustrated in Fig. 43c.

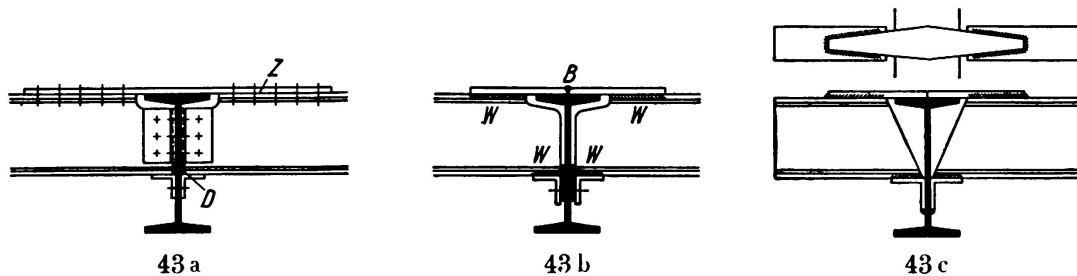

Fig. 43.

Details of connections

D pressure piece, Z tensile cover plate, B erection joint, W shop joint.

Encasing the steelwork.

Floor girders, joists and the horizontal members of vertical frames are as a rule embedded in the ceiling and are thereby protected against corrosion and also against fire. The same purpose is served by encasing the uprights. If the latter consist of several rolled sections, the space between them is also filled with concrete. It is obvious that this concrete may also be used to carry load. The problems arising in this connection were treated very fully at the Paris Congress in 1932⁴⁹; some more recent German publications on this subject are mentioned below⁵⁰.

Summary.

The foregoing article deals in a general manner with the development of hall structures and steel framed buildings. Among the hall structures discussed are railway station halls, exhibition and sample fair halls, airship and aeroplane halls, and tramway and motorbus halls. Reference is made to the dimensions and shapes of the halls, and also to lighting and ventilating. Further, in the case of airship and aeroplane halls the development in the design of the doors is described.

In steel framed buildings, the form of the steel structure in plan and in elevation is of interest. Closely connected with this is the question of taking the wind forces. After that, structural details are considered, and how they have developed in course of time. Finally, some reference is made to the problem of encasing the steelwork.

⁴⁸ P-Träger 1935, p. 7.

⁴⁹ International Association for Bridge and Structural Engineering, first Paris Congress 1932. Preliminary Publication, pp. 587ff.; Final Report, pp. 516ff.

⁵⁰ Stahlbau 1934, pp. 49ff.; 1935, pp. 81ff.; Zentralblatt der Bauverwaltung 1935, p. 536.

Leere Seite
Blank page
Page vide