

Ib. Means for increasing the tensile strength of concrete and reducing cracking

Objektyp: **Group**

Zeitschrift: **IABSE congress report = Rapport du congrès AIPC = IVBH
Kongressbericht**

Band (Jahr): **2 (1936)**

PDF erstellt am: **21.07.2024**

Nutzungsbedingungen

Die ETH-Bibliothek ist Anbieterin der digitalisierten Zeitschriften. Sie besitzt keine Urheberrechte an den Inhalten der Zeitschriften. Die Rechte liegen in der Regel bei den Herausgebern.

Die auf der Plattform e-periodica veröffentlichten Dokumente stehen für nicht-kommerzielle Zwecke in Lehre und Forschung sowie für die private Nutzung frei zur Verfügung. Einzelne Dateien oder Ausdrucke aus diesem Angebot können zusammen mit diesen Nutzungsbedingungen und den korrekten Herkunftsbezeichnungen weitergegeben werden.

Das Veröffentlichen von Bildern in Print- und Online-Publikationen ist nur mit vorheriger Genehmigung der Rechteinhaber erlaubt. Die systematische Speicherung von Teilen des elektronischen Angebots auf anderen Servern bedarf ebenfalls des schriftlichen Einverständnisses der Rechteinhaber.

Haftungsausschluss

Alle Angaben erfolgen ohne Gewähr für Vollständigkeit oder Richtigkeit. Es wird keine Haftung übernommen für Schäden durch die Verwendung von Informationen aus diesem Online-Angebot oder durch das Fehlen von Informationen. Dies gilt auch für Inhalte Dritter, die über dieses Angebot zugänglich sind.

II b

Means for increasing the tensile strength of concrete
and reducing cracking.

Mittel zur Erhöhung der Zugfestigkeit und zur Verminderung
der Rissebildung des Betons.

Moyens d'augmenter la résistance à la traction et de diminuer
la formation des fissures dans le béton.

Leere Seite
Blank page
Page vide

II b 1

The Elimination of Tension in Concrete, and the Use of High Tensile Steel by the Freyssinet Method.

Der Ausschluß von Betonzugspannungen und die Verwendung hochwertigen Stahles durch das Freyssinet-Verfahren.

L'élimination de la traction dans le béton et l'application de l'acier à haute résistance suivant la méthode Freyssinet.

Hon.Prof. Dr. Ing. K. W. Mautner,
(früher Technische Hochschule Aachen) Frankfurt a. M.

Knowledge as to the causes and importance of crack formation in reinforced concrete has made great progress. Precautions against cracking extend both to the choice of suitable material and to proper constructional procedure, but so far it does not appear that advances made in producing cements of higher tensile strength will play an important part in these precautions; nor does attention to the choice of aggregates and of the water-cement ratio, and to the after-treatment of the concrete, offer more than partial guarantees of success; and these controls are not practicable in all circumstances. The adoption of specially shaped reinforcing bars, which has become customary in conjunction with the higher stresses in certain kinds of steel (Isteg and other types of deformed bars) indeed offers some improvement from the point of view of bond, and therefore some reduction in the risk of the steel slipping and giving rise to large cracks; but the greater part of the advantage so gained is discounted by the heavier permissible stresses in such steel, which are attended by heavier than normal stresses in the concrete. The fact that the unavoidable shrinkage is in itself sufficient to cause tensile stresses without any load being on the structure when (as is most often the case) the reinforcing bars are placed eccentrically, and that the calculated values of such stresses may be up to the limit of the available tensile strength, is only slightly mitigated by plastic tensile strain; for such strain can be significant only in cases where the concrete is relatively weak, and this in turn implies that the tensile strength is low.

The possibility of improving matters by suitable choice of materials would appear, therefore, to have reached its limit. As a rule the criterion for distinguishing between dangerous and harmless cracks is taken to be that the width of the crack shall not exceed an amount variously given as 0.2 to $\frac{2}{3}$ rds mm. In principle it may be laid down that such cracks as cannot be prevented from

arising when the permissible stresses in the concrete and steel are attained (the maximum elongation at fracture of the concrete, under bending, being approximately 0.3 mm per metre) are not to be regarded as dangerous. The distinction between harmless and dangerous cracks is however, very vague, being influenced by the situation of the job and by the effects of weathering, and above all by the effects of repeated stressing and impact.

In view of this fact the regulations which are operative in various countries continue to fix limits for the tensile stresses, although it is known that these limitations are of little value for the reason that the initial stresses cannot be estimated. In the German regulations for reinforced concrete bridges, for instance, the tensile stress is limited to $\frac{1}{5}$ th of the cube strength, and the French regulations of 1934 are similar in their implication, though applicable only to oblique principal stresses.

It is therefore an advance, the importance of which it would be impossible to exaggerate, that a reliable means altogether different from those suggested above has now been found for eliminating all tensile stresses (including those which are not dangerous), and of doing this without exceeding the limits of what is economically feasible. The methods proposed by *M. Freyssinet* in the Preliminary Publication combine the following advantages:

1) Certainty of eliminating all tensile stresses in a member exposed to bending or to eccentric pressure, with consequent elimination of all risk of cracking.

2) Apart from the matter of freedom from cracking, which is germane to the present report, there is the circumstance that the whole of the cross section of the concrete can be utilised for compression so that a member is made to resist bending to the full extent of its cross section and resisting moment, and can be calculated as if it were a homogeneous body.

3) This makes it possible for the same compressive stresses in the concrete to take up much heavier bending moments, or alternatively, if higher permissible stresses can be accepted in the concrete, it is possible considerably to reduce the size of cross section and therefore the amount of material required.

4) Variations and repeated alternations in load no longer play any appreciable part in determining the risk of cracking, and variations in stress in the reinforcing bars are minimised by contrast with what is true of structures designed in accordance with Stage IIb.

As is well known, *M. Freyssinet* has obtained these revolutionary advantages in reinforced concrete construction mainly through the adoption of pre-stressing both of the longitudinal steel and of the stirrups. This principle has long been understood, but earlier applications, as for instance those attempted by *Koenen* and *Lund*, have been defeated by two difficulties:

1) The pre-stressing was so light that the whole of its effect was lost by shrinkage, plastic deformation and drop in temperature.

2) It was not possible for the engineers concerned in these attempts, and for those who later took up the problem, to devise practical means of pre-stressing which would be certain in their effect and at the same time economical.

Freyssinet himself succeeded not by developing the idea of pre-stressing by itself, but by combining it intimately with the following measures:

1) By making the amount of pre-stressing very heavy, somewhere between 4000 and 7000 kg/cm², and by the use of steels with yield points of 8000 to 12 000 kg/cm².

2) By adopting a constructional arrangement so designed as to ensure uniform pre-stressing of the steel reinforcements, the necessary anchorages being connected either to the shuttering or to its sub-structure in such a way that the pre-stressing operation would be perfectly carried out and the apparatus afterwards disconnected by simple means.

3) Neither of these two conditions could be fulfilled without radical improvement in the production of the concrete itself. It would be both difficult and uneconomic to maintain these heavy pre-imposed stresses in the steel long enough for the concrete to harden sufficiently to pick up the stresses. *Freyssinet*, therefore, devised a means of making concrete of medium and high compressive strength in less time than ever before, using a process which he has described as "virtually instantaneous hardening" (*endurcissement quasi instantané*); a process which offers the further advantage that concrete beams, posts, piles and pipes can be formed in short lamellar layers, whereby the expense of complicated shuttering is reduced to a fraction. The principle of this "virtually instantaneous hardening" has been described in the Preliminary Report, and depends on subjecting the concrete to vibration, compression and heat; the practical significance of these treatments has been discussed in detail in the Publications of the I.A.B.S.E., Vol. IV, and here it need merely be stated that vibration has the effect of so arranging the small particles of aggregate as to reduce the voids; the effect of pressure is further to reduce these voids; and after both these processes have been carried out it is permissible to apply heat, since the capillarity of the voids effectively reduces the loss of moisture by evaporation.

It is to be noticed that none of these three processes by itself gives the desired result. It is known, for instance, from the vibration tests carried out by *Graf* and *Walz* at Stuttgart, that the vibration of plastic watery mixtures such as are used in reinforced concrete work, containing large quantities of sand, does not by itself cause any reduction in the time required for hardening nor any improvement in quality. It is only applying pressure to increase the density, that the limited void content resulting from the packing of the small particles makes it possible to apply heat. This additional heat considerably increases the total present due to the setting of the cement.

This process has been carried out not only in the laboratory, but also on actual work for making masts, solid and hollow piles, pressure pipes and beams of large dimensions. The results vary according to the shape of cross section; with closed and compact sections strengths corresponding to those obtained after 28 days in ordinary reinforced concrete work, or even considerably higher, are obtained in a very short time. With other forms of cross section, as for instance I-beams, the shuttering is removed after a few hours and an initial strength of 150 to 200 kg/cm² is secured, which is enough to allow either of another piece being begun or of the pre-stress being transferred into the concrete.

Owing to the fact that longitudinal tensile stresses are entirely eliminated it becomes possible by suitably pre-stressing the stirrups to render the principal stresses entirely compressive, and the question of permissible compressive stresses for concrete made on the site assures a fundamentally new aspect.

In the customary form of reinforced concrete design, assuming the presence of a tensile zone, the permissible compressive stress in the concrete is quite properly based upon a higher factor of safety than that which governs the steel stress referred to the elastic limit. As a rule this implies a considerably higher factor of safety as regards the permissible compressive stress in the concrete; a differentiation which is justified only by the greater uncertainty which attends the production of concrete by comparison with that of steel in the steel works, but also, more pertinently, by the question of freedom from cracking. If, then, the compressive stress in the concrete is notably increased, the calculated tensile stress in the concrete will likewise be increased, and the limitation of cracks will become more difficult. Apart from this, in T-beams an increase in the compressive stress in the concrete is associated with a crowding together of the steel bars, which may itself tend to cause cracking. Both these components of safety as affecting concrete compressive stresses are eliminated by the *Freyssinet* system, and the only remaining reason for the concrete being made subject to a somewhat higher factor of safety than is possessed by the steel referred to its elastic limit lies in the different conditions of their manufacture; not on any effect of the increased concrete compressive stress on the design. There is, therefore, no point in fixing the permissible compressive stress in the concrete at about $\frac{1}{3}$ rd of the 28-day cube strength, because when the *Freyssinet* system is applied compressive stresses in the concrete of 150 kg/cm² are obtained even in unfavourable cases, and these may straight away be looked upon as permissible values.

As regards alterations occurring in the steel stresses under live load (particularly under moving loads) it is to be remembered that since the neutral axis lies approximately at the lower edge of the beam the whole cross section co-operates, so that variations in the steel stress will amount only to n times the variations in the concrete compressive stress. This is relatively quite a small fraction of the initial stress, contrasting in this respect with reinforced concrete construction with a tension zone.

The use of high elastic limit steels, without pre-stressing, as hitherto practised, is known to have resulted in increased safety against breakage but not in any increase in safety against cracking, though deformed bars have been proved efficacious with regard to bond and to sub-division of the cracks. The increased steel stresses adopted with these kinds of steel, with correspondingly greater elongation, increase the danger of crack formation, thus contrasting with the effect described above. With the *Freyssinet* system the high tensile steel which is pre-stressed no longer performs the same function as is performed by reinforcement in ordinary construction; it merely serves to take up the heavy eccentric pre-imposed stress, and contrary to what happens with high tensile steel used without pre-stress it results in an avoidance of cracks. Hence all the arguments against the adoption of high tensile steel become invalid, and this applies particularly to the objections which have been raised to the use of cold-

stretched steels. Any apprehension is easily overcome by the fact that these qualities of steel may be produced by suitable alloying without cold stretching. By reason of the high stress in the steel it is not necessary to make use of exceptionally large diameters; hence anchorage by the usual form of hooks involves no risk.

The application of the method extends to a great many types of construction. It is already well known how hollow piles of almost unlimited length have been made in this way, an operation of which *M. Freyssinet* has given an account in the literature (see also the Preliminary Report of the Congress), in the reconstruction of the marine station at Le Havre. In addition, the production of thin walled high tension pylons for power transmission has been practised for some years. Quite recently two applications of the method have been developed both in the laboratory and on actual work which deserves special attention here, namely (1) the production of long span beams, and (2) the production of high pressure pipes of large diameter for heavy pressures both in service and under test.

There is neither space nor occasion here to give details of the constructional arrangements adopted for producing pre-stress, or of the qualities of the "virtually instantaneous hardened" concrete; these matters must be left for later description. The underlying principle of the system may, however, be briefly mentioned: the pre-stressing is carried out either with the aid of the shuttering itself or with that of its supporting structure, and usually by means of hydraulic jacks. Contrary to what was found in the earlier experiments by other workers, it is possible with safety to make use of pre-stressing loads as high as 1000 tonnes. Another method, which is particularly interesting, is to make use of the concrete itself for pre-stressing the steel reinforcement. This method is quite new and is being widely adopted. The idea of using the concrete itself to pre-stress the steel bars may at first sight appear difficult to understand, but it may be readily understood by recalling the heavy shear and compressive resistance offered by concrete which has been placed while in a fluid condition, and has been systematically dewatered and subjected to heavy pressure on all sides. Here, as a rule, such pressure is imposed by means of tight inflatable rubber sheaths connected to the shuttering. The theoretical principle underlying this process (which has met with great success in practice) have been explained by *Freyssinet* by reference to considerations recently put forward by Caquot in his *Equilibre des Massifs à Frottement Interne* (Paris, 1934).

A brief outline of the stress conditions obtaining in long span beams will now be given, reference being made to the treatment of the subject of "Long Span Girder Bridges" at the Paris Congress in 1932 in which the economical constructional limits of span were found to be determined by the tensile stress of the concrete and the space taken up by the reinforcing bars. In this consideration of long span beam bridges the unfavourably small ratio between live load and dead load moments plays a vital part, and the ratio in question is one which becomes smaller still in proportion as the span increases. At the same time it is proper to observe that this circumstance, unfavourable as it is from an economic point of view, has frequently been put forward as an advantage of reinforced concrete construction, by reason of the fact that variations in load and in the stress of the reinforcing bars are in this way reduced. In the case of beams

constructed by the pre-stressing method much more favourable (that is to say much greater) ratios between the live load and dead load moments are obtained, while at the same time the advantage of limited variation in stress under repeated fluctuations of load is ensured, because — as explained above — the whole cross section collaborates.

Fig. 1 shows an experimental beam constructed in Germany on the *Freyssinet* system, in which all the dimensions of the steel reinforcing bars and of the

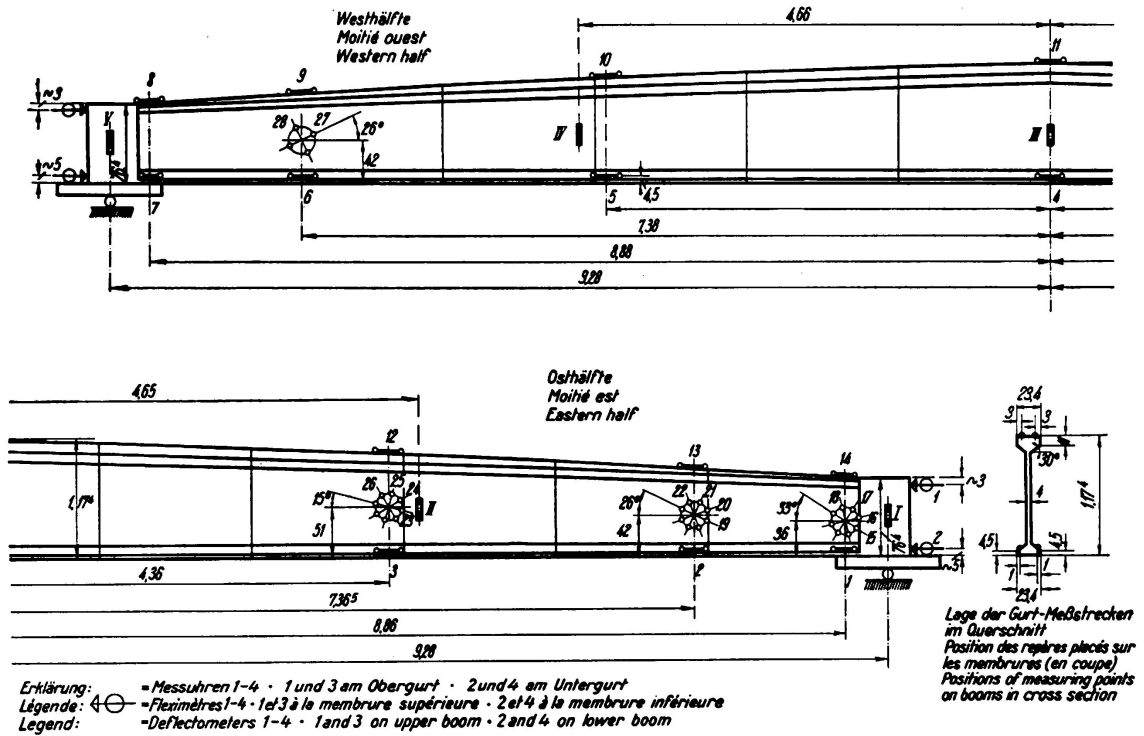

Fig. 1.
Arrangement of measuring points.

spaces between are made exactly to a scale of 1:3, representing a roof girder over a hall of 60 m span. The model reinforced concrete beam has, therefore, a span of approximately 20 m; the pre-imposed stress in the reinforcing bars is 5500 kg/cm², which gives the following moments at the central section:

From own weight, and loading frame	. 9.67	m-tonnes
From live load 59.5	m-tonnes
Total, approximately 69,2	m-tonnes.

The maximum concrete stress due to own weight plus maximum live load plus loading frame amounts to:

In the upper flange	143.7 kg/cm ² compression
In the lower flange	18.9 kg/cm ² compression.

The neutral axis thus falls below the lower edge of the beam. With a pre-stress of only 3500 kg/cm² the stress in the upper flange amounts to 160 kg/cm² and

that in the lower flange to 40 kg tension. With a pre-stress of about 5000 kg/cm² the lower flange stress at the soffit of the girder is exactly zero; the total compression in the lower flange amounts to 205 kg/cm² due to the pre-stress alone without counting the "own weight".

The girder has a cross section of 1008 cm² at the centre, and its lower boom is reinforced with 64 round bars of 5.4 mm dia., corresponding in scale to bars of 16 mm dia. in the full sized construction. As already mentioned above, the girder was constructed in lamellar stages in such a way that altogether twelve pieces are arranged in sequence along the length. The construction and hardening of such a member required only a few hours. Before the pre-imposed stress was transferred onto the concrete shrinkage cracks appeared at the horizontal boundaries between the lamellae, the width of which was estimated at 1/20th mm. After the transfer of the pre-imposed stress these shrinkage cracks closed up so that they could no longer be detected with the naked eye, and the lime wash which had been painted over for purposes of measurement was observed to flake off. Measurements of elongation in the flanges, made in the direction of the principal stresses and in that of the bisectors between the principal stresses and the axes, were carried out by the Materials Testing Laboratory of the Technische Hochschule at Stuttgart, and these showed that *all the principal stresses were compressive*.

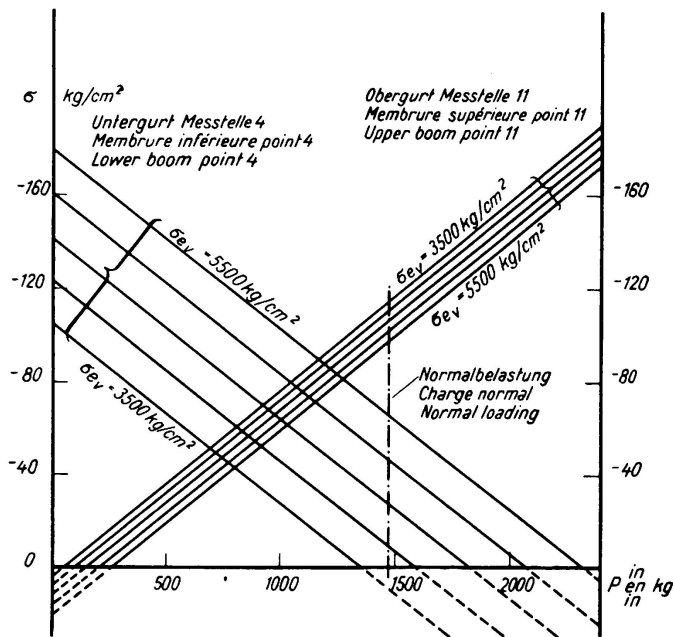

Fig. 2. Section on centre line.

The following observations may be recorded (Fig. 3). With a pre-imposed stress of 5500 kg/cm² the girder acted under full load like a homogeneous girder, the whole cross section co-operating to provide resisting moment against bending. No tensile stresses arose either in the lower boom or in the directions of the principal stresses, nor in any other direction. The deflection of the girder was relatively very small as a result of the large resisting moment; it amounted to only 1:750, corresponding to that of a steel girder of similar cross section stressed to only 500 kg/cm².

The following observations may be recorded (Fig. 3). With a pre-imposed stress of 5500 kg/cm² the girder acted under full load like a homogeneous girder, the whole cross section co-operating to provide resisting moment against bending. No tensile stresses arose either in the lower boom or in the directions of the principal stresses, nor in any other direction. The deflection of the girder was relatively very small as a result of the large resisting moment; it amounted to only 1:750, corresponding to that of a steel girder of similar cross section stressed to only 500 kg/cm².

The explanation of this exceptionally favourable distribution of stress is to be found in the pre-stressing of the longitudinal bars and stirrups. As is well known, the principal stresses corresponding to the stresses σ_x and σ_y are given by

$$\sigma_{I, II} = \frac{1}{2} (\sigma_x + \sigma_y) \pm \frac{1}{2} \sqrt{(\sigma_x - \sigma_y)^2 + 4 \tau^2}; \quad \text{tg } 2 \varphi = \frac{2 \tau}{\sigma_y - \sigma_x}$$

With ordinary reinforced concrete construction at the neutral axis $\sigma_x = \sigma_y = 0$; hence the inclined principal stress $\sigma_{II} = -\tau$ is at an angle of $\varphi = 45^\circ$. It is clear that the effect of the normal stress σ_x (pre-imposed compression) is to

diminish the principal tensile stress. If Mohr's diagram be drawn (Fig. 4) with $\sigma_x = \tau$ there is obtained a principal tensile stress of

$$\sigma_{II} = \frac{\tau}{2} (1 - \sqrt{5}) = -0.618 \tau$$

If $\sigma_x = 2\tau$ the maximum principal tensile stress becomes $\sigma_{II} = -0.414$. If, finally, besides $\sigma_x = \tau$ a vertical pre-stress is imposed by means of stirrups, the principal tensile stress becomes $\sigma''_{II} = 0$ and the principal compressive stress $\sigma''_I = 2\tau$. This condition can easily be obtained by stressing the stirrups, as was done in the present case. As regards shear effect, tensile stresses are entirely eliminated and the shear stress may therefore be brought up to one half of the permissible compressive stress.

With concrete compressive stresses of approximately 145 kg/cm^2 as already stated, the girder suffices to carry a live load amounting to seven times its own weight.

The girder to be actually constructed would have a cross section of 0.84 m^2 at the centre, and the

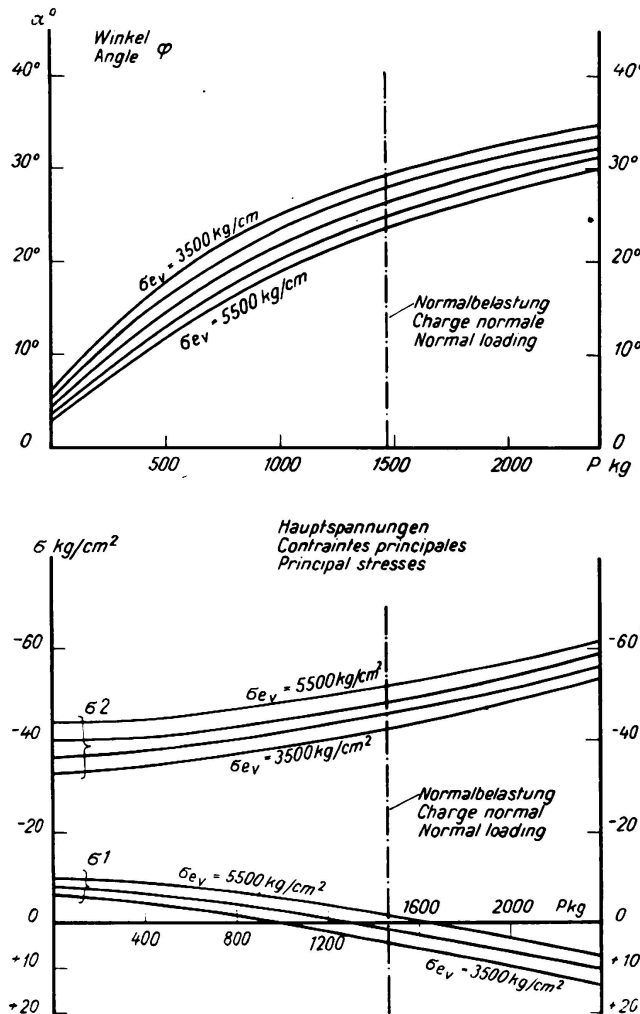

Fig. 3.

Section 1—14.

total moment at the centre of the span would then amount to about 2000 m-tonnes, the ratio between the live load moment and the dead load moment being approximately 1.2. If these spans, not hitherto realised with solid webbed girders, are compared with those of existing bridges, the very favourable relationship of live load to dead load moment will become evident.

A girder of 100 m span subject to the same stresses would have an average "own weight" of 5 tonnes per m run, and would be able to carry a live load of 3 tonnes per metre run, it being assumed that the permissible compressive stresses are kept suitably low.

High pressure pipes have been constructed on the same principle, the steel reinforcing bars being pre-stressed by compression of the concrete itself while supported all round and subjected to an increase of internal pressure. The following results were obtained:

Small test pipes of 440 mm internal dia., and 37 mm thickness of wall, were exposed to a test pressure of 90 atmospheres without any detectable loss of water. By contrast with this a pipe of the same dimensions and containing the same amount of reinforcement, but not pre-stressed, was unable to withstand a pressure in excess of 6 atmospheres without loss of water-tightness. It is particularly notable that the empty pipe had to withstand a compression of 550 kg/cm² due to the pre-stressing at the instant of its removal from the forms, and this happened within a few hours of its manufacture.

The same principle is now being applied, in actual practice, to the continuous production of high pressure pipes of large diameters. Thus pipes of 800 mm dia., with walls 5 cm thick, for test pressures up to 16 atmospheres, have been produced without any defects, and are removed from their shuttering a few hours after the beginning of the process of manufacture. Under these conditions the concrete when removed from the moulds is subject to a compressive stress of 140 kg/cm² about three hours after it has been deposited. It is particularly notable that if such pipes are purposely exposed to pressure in excess of the usual test pressure, so as to cause them to sweat, they again become perfectly water-tight after the pressure has been relieved, and remain so when the pressure is again increased up to the permissible amount. This shows that the effect of pre-stressing is completely to close up any cracks that may have been formed by statical effects; a result which is of great importance as regards resistance to impact effect (from water hammer).

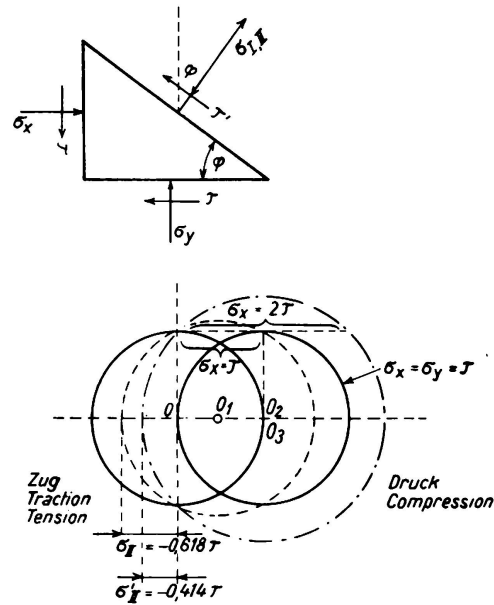

Fig. 4.

II b 2

Reducing the Risk of Cracks in Reinforced Concrete Structures.

Die Erhöhung der Rißsicherheit bei Eisenbetonbauten.

L'amélioration de la sécurité à la fissuration dans les ouvrages en béton armé.

Regierungs- und Baurat a. D. Dr. Ing. W. Nakonz,
Vorstandsmitglied der Beton- und Monierbau A.-G., Berlin.

The difficulty of ensuring that reinforced concrete structures, however well reinforced, shall be entirely free from defects and cracks is known to every specialist. Fine hair cracks are in fact present in the majority of reinforced concrete beams, and are due to the tensile strength of the concrete having been exceeded by the bending stresses which result from the dead weight of the beam and the imposed loads in addition to temperature and shrinkage stresses, or, in most cases, to a combination of such stresses.

These fine hair cracks have no effect on the carrying capacity of the structure, as the tensile strength of the concrete has been left out of account in the statical calculations and all stresses on the tension side are carried by the steel embedded therein. The hair cracks may, however, afford a channel whereby in course of time the surrounding air may penetrate to the steel and cause rusting if it is damp or acidic. Twenty-five years ago this danger was the subject of lively discussion among engineers, but experience has since shown that in carefully executed reinforced concrete work it does not exist and that no fear need be entertained of the reinforcing steel being gradually destroyed through rust in this way.

In the last few years the question of the freedom of concrete from cracking has, however, again come to the fore in connection with the use of high tensile steels and with the execution of structures of ever increasing span. In accordance with the German regulations for reinforced concrete the type of commercial steel which has hitherto chiefly been used may be stressed up to 1200 kg/cm² in ordinary cases, and more recently a permissible stress of 1500 to 1800 kg/cm² has been authorised for St. 52. Generally the adoption of these higher stresses in the steel is associated with higher tensile stresses in the concrete, with the result that the margin against cracking becomes smaller.

During the past ten years the spans of girder bridges have continually been increasing. Thus the bridge across the Danube at Grossmehring, completed in 1930, has a span of 61.50 m over the central opening, and the bridge of the SA in Bernburg crosses the Saale by a span of 61.78 m. Both of these are girder bridges with a suspended span in the central opening over the water. Large

halls have been built as two-hinged frames of approximately 53.0 m span, and at the end of this paper reference will be made to a statically determinate roof structure carried on two supports at a clear distance of 50.0 m with a span of 50.80 m between centres of bearings.

It is to be anticipated that this process of development will continue, and that in the future even greater spans will be bridged by reinforced concrete structures subject to bending. In these large spans it becomes of cardinal importance to reduce the dead weight to a minimum, and the sections of the reinforced concrete members must, therefore, be made as light as possible. As a result, the portion of the cross section of concrete which is stressed in tension will be reduced in area; the tensile stress therein will be correspondingly greater and the safety against cracking will be smaller.

The direct tensile strength of concrete such as is used in reinforced concrete structures lies between 12 and 25 kg/cm² according to the quality of the work. The bending tensile strength, which as a rule affords a better standard of comparison, may be taken as 25 to 30 kg/cm², but it is to be noticed that the upper limit is reached only with the best possible workmanship, using aggregates of the highest possible quality and a correspondingly small water content.

The extensibility of concrete in tension lies between 0.1 and 0.2 mm per m; that is to say when this amount of elongation is exceeded the concrete begins to crack. In selected types of concrete it may be possible to increase the amount to 0.3 mm per m. In making this statement no account has been taken of plastic strain, the magnitude of which, in concrete under tension, has hitherto been little investigated, and the possible effect of which may be to increase the total elongation two or three times.

The shrinkage of concrete suitable for use in reinforced concrete structures is usually given as about 0.4 mm per m, a large proportion of the total shrinkage being attained by the end of a few months. The concrete continues, however, to shrink slowly for a further period, and does not reach its final dimensions till the end of about five years. The rate at which shrinkage proceeds is greatly influenced by the degree of dampness or dryness of the surrounding air. It is known that concrete will shrink very rapidly in warm dry rooms whereas under water it will not shrink at all, but on the contrary, will swell.

The shrinkage value of 0.4 mm per m as stated above can only be taken as a laboratory figure. In massive structures, and indeed in all-work out of doors, the shrinkage is less, being reduced by the natural dampness of the surrounding air. If the amount of shrinkage be reckoned at 0.15 to 0.20 mm per m a considerable part of the extensibility available in the concrete will already have been utilised even if it be assumed that plastic deformation has operated to relieve the load. It has been shown that reinforced concrete structures inside closed buildings and exposed to rapid drying may show fine hair cracks from shrinkage alone.

In the case of reinforced concrete girders of long span the tensile stress imposed on the concrete by shrinkage is usually smaller than the stresses caused by the external loads, particularly those due to dead weight and live load, and possibly the temperature stresses. Elongations of 0.2 to 0.4 mm per m must be reckoned with if the construction is to be economically feasible, and in most

cases this in itself implies that the extensibility of the concrete is exceeded, with the result that the fine cracks on the tension side will become more pronounced and be apparent even to the unpracticed eye.

It is easy to understand the desire that these cracks should, as far as possible be eliminated, even though in most cases they are merely defects of appearance. The most effective solution to this problem would be for the cement industry to produce a cement capable of conferring a higher tensile strength on the concrete, or alternatively one which would reduce the modulus of elasticity E for concrete in tension, thereby increasing the elongation.

It is obvious that comparison with natural stones affords no great hope of this, for the latter all possess much higher compressive than tensile strengths. Another warning against exaggerated expectations may be found in the fact that during the past few decades scarcely any advance has been made in the matter of increasing the tensile strength of concrete. If, however, it became possible merely to increase the *bending* tensile strength of a good concrete, which may to-day perhaps be put at 40 kg/cm², by some 50% to 60 kg/cm², a great step forward would have been made, and many forms of structure would become possible which at present are excluded by the risk of cracking. Having regard to the low value of the tensile strength of concrete as such, a 50% increase within a reasonable time may not perhaps, be outside the bounds of possibility.

A further measure that might be generally adopted would be so to regulate the final distribution of stress, by the use of pre-stressing, that the tension in the concrete would be limited to an acceptable amount. Such pre-stressing might be applied either to the concrete or to the steel, but in the former alternative it would be necessary to use a type of cement which expands instead of contracting as does the cement now in use. Whether the cement industry is in a position to produce a cement of this kind is an open question: according to an article by *Henry Lossier*, «Les Fissures du Béton Armé»,¹ the French industry appears likely to do so in the near future.

Attempts to pre-impose a stress in the concrete through the medium of the steel are almost as old as reinforced concrete construction itself, having been suggested by *Koenen* in a paper entitled „Verfahren zur Erzeugung einer Anfangsdruckspannung in Zuggurtbeton von Eisenbetonbalken“ which appeared in the *Zentralblatt der Bauverwaltung* in 1907.

To ensure that no cracks shall appear in the concrete, which implies that the tensile strength of the latter must never be exceeded, it is necessary to calculate and dimension the structure in such a way that the bending tensile stress σ_{bz} is kept within reasonable limits. According to the present practice of reinforced concrete design it is quite rightly customary to take no account of the bending tensile stress, for this affords no proper basis for calculation, and is affected by shrinkage, which in turn depends on the arrangement and cross section of the steel. The regulations for reinforced concrete are so framed that if they are carefully and correctly followed there is no chance whatever of hair cracks arising. According to DIN 1075, „Berechnungsgrundlagen für massive Brücken“ an

¹ Le Génie Civil, 1936, pages 182 following.

estimation of the bending tensile stress is necessary in reinforced concrete girder bridges of more than 20 m span, and the matter is governed by the requirement that σ_{bz} must not be greater than one fifth of the calculated compressive strength of the concrete, failing which special precautions are to be taken against dangerous cracking. This regulation is important, and might well be applied in a similar way to roof trusses of large span or to other such structures in reinforced concrete building work.

In an article entitled „Die Donaubrücke Großmehring“² the author has calculated the maximum tensile bending stresses in a series of long span reinforced concrete girder bridges and obtained values between 37 and 47 kg/cm². In the bridge over the Saale near Bernburg, already mentioned, the corresponding

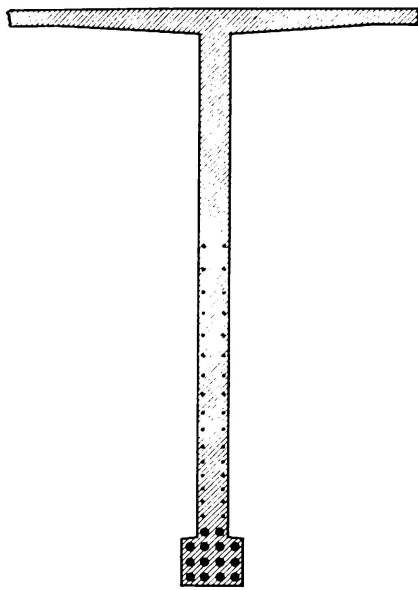

Fig. 1.

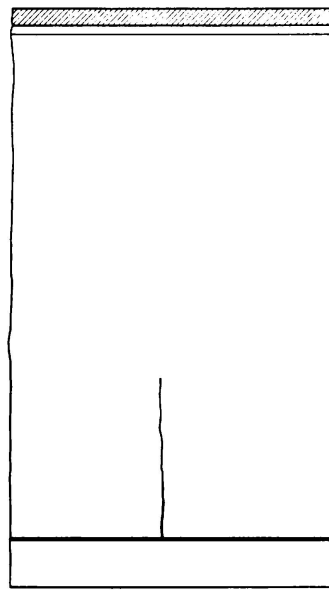

Fig. 2.

maximum value of σ_{bz} is 55 kg/cm². In the present state of concrete technique it would appear inadvisable to exceed this upper limit without quite special precautions.

In reinforced concrete structures of long spans the girders are even now being made of considerable height, for instance in the bridge over the Danube near Grossmehring which has already been mentioned several times the depth is 2.75 m at the middle of the span and 5.40 m over the bearings. When the cross section is of this magnitude the calculated tensile reinforcement placed close to the extreme fibre may properly be supplemented by adequate longitudinal reinforcement below the surface covering the whole of the tension zone, with a view to preventing the formation of cracks between the actual tensile reinforcement and the neutral axis, or at any rate to lessen their concentration. In the case of a section like that shown in Fig. 1, wherein the lower boom has been widened to accommodate the necessary tensile steel, it has been found that whereas the concrete shows no tendency to crack in the enlarged section at the bottom,

² Zentralblatt der Bauverwaltung, 1931, pages 123 following.

it is apt to do so in the relatively thin web portion above, and the purpose of the longitudinal bars indicated in Fig. 2 is to combat this tendency. The presence of a large number of steel bars in the lower boom portion has the effect of increasing the extensibility of the concrete there, and this is supplemented by some measure of plastic deformation, which explains the absence of cracking.

Two mistakes that are frequently made may be mentioned at this juncture: the first is that of crowding many hooks into the same cross section, and the second is the occurrence of changes in the cross section due to openings or offsets. Wherever possible hooks should be avoided in the tension zone of the concrete, though this may not always be possible in cross sections subject to great variation in stress, as for instance at the corners of frames; in any case however, it is undesirable that a number of bars should terminate in hooks at the same place. The presence of the bent hooks is equivalent to a considerable

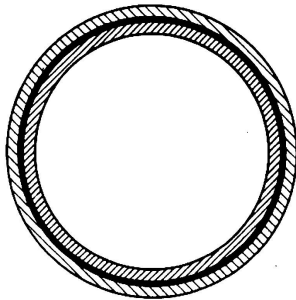

Fig. 3.

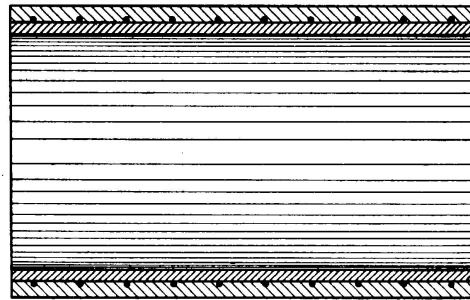

Fig. 4.

reduction in the cross section of concrete which may originate a crack at the point affected.

For similar reasons, openings or sudden changes in section are undesirable and even small openings like those required for the passage of cables and the like should not, if possible, be placed in the tension zone. If such an arrangement is unavoidable additional steel should always be placed around them in order to prevent the formation of cracks.

The expedient of subjecting the steel to a preliminary stress as mentioned above has frequently been followed with success in the case of reinforced concrete members produced under factory conditions. An interesting example of this is provided by the Ruml pipe, in which the annular reinforcements are pre-stressed so as to avoid the occurrence of tension in the concrete under the tangential forces which result from heavy hydraulic pressure inside, and on account of the pre-stressing only compressive stress arises.³ Fig. 3 shows a cross section and Fig. 4 a longitudinal section through such a pipe. The inner portion, as far as the steel, is concreted first in suitable shuttering, and when this has hardened the steel reinforcement heated in an oil furnace is wound tightly over the concrete core, the third stage of the process being the formation of the outer portion of the concrete. It is claimed that these pipes are completely water-

³ See „Eisenbetonrohre R. T. System Ruml“, by Dr. F. Emperger, Beton und Eisen, 1931.

tight even under pressures of ten atmospheres, and they have been widely used in Czechoslovakia and several other countries.

Where reinforced concrete structures are built on the site, pre-stressing has been used with success for purely tension members such as for instance the anchorage of a roof truss or an arch bridge. At the suggestion of *Dischinger*, tie-bars for taking up the horizontal thrust of reinforced concrete arch bridges have been pre-stressed by the use of hydraulic jacks. *Pujade-Renaud* in a paper entitled «Les hangars triples à hydravions de la base maritime de Karouba (Tunisie)»⁴ has described French aeroplane hangars with roofs of arched construction wherein the horizontal thrust, if too great to be resisted by the ground itself, is withstood by circular steel bars extending from one bearing to another and embedded in the ground. In this instance the pre-existing stress has been obtained by forcing the bars apart at their centre.

Pre-stressed tie-bars of this kind have also been successfully applied in Germany for large covered hall structures built in the form of arches. Usually hydraulic jacks have been employed, by means of which the desired amount of load can be accurately imposed.

Figs. 5 and 6 show a wide span roof over a hall without intermediate supports consisting of relieved arches of 100 m span between the abutments. The arch ribs are placed at 5 m centres and bear at each end on continuous abutments, to which the anchorage of 40 m diameter bars is attached in the usual way by means of hooks embedded in the concrete. The tie-bars were interrupted at the centre of the hall in order to insert the hydraulic jacks used for pre-stressing, an arrangement which offers the advantage that the full half length of the tie-bars, measuring 53 m, could be obtained ready made from the rolling mills and did not therefore need to be welded on the site. Details of the joints in the tie-bars and the method of stressing are shown in Fig. 7: the bars connected to the left hand abutment are secured at their right hand ends in an anchoring beam to the right of the centre of the hall, and those which connect with the right hand abutment are similarly embedded at their left hand ends in a second anchoring beam placed to the left of the centre line. The respective tie-bars from either side thus overlap by about 3 m at the middle; those coming from the left pass through the left hand anchoring beam, and those from the right through the right hand anchoring beam, by the way of gas pipes. Hydraulic jacks of 50 tons lifting capacity were placed in the space between the two anchoring beams, enabling the latter to be forced apart and the required stress imposed in the tie-bars. This pressure was applied simultaneously with the removal of the scaffolding which was carried on screw jacks, and during the operations the relative positions of the abutments were read on Zeiss dials giving an accuracy of $\frac{1}{100}$ mm. A certain amount of tension was first applied to the tie-bars and the lowering of the scaffold was then begun: as soon as the Zeiss instrument on the abutments began to indicate a movement the pre-stress was increased and the scaffold was lowered by a further amount, and so on alternately until the calculated amount of pre-stress had been obtained in the

⁴ "La technique des travaux", 1934, pages 85 following.

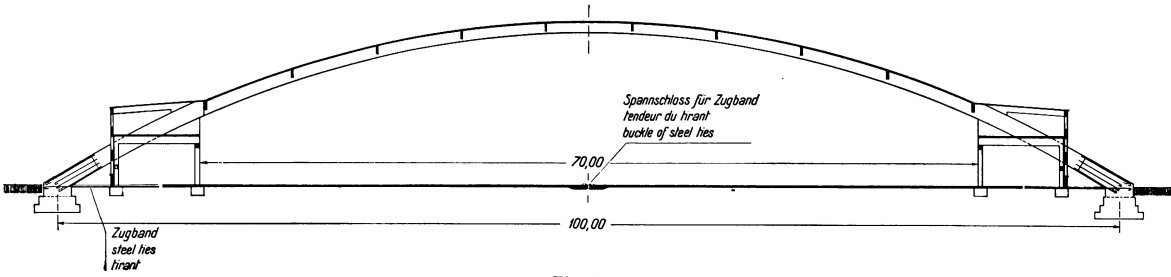

Fig. 5 .

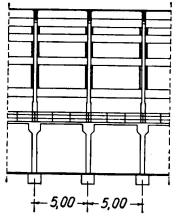

Fig. 6.

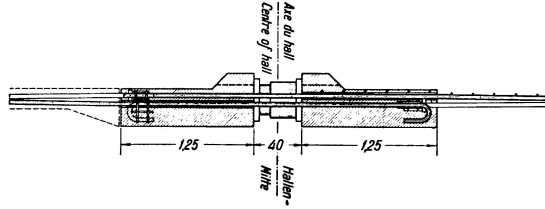

Fig. 7.

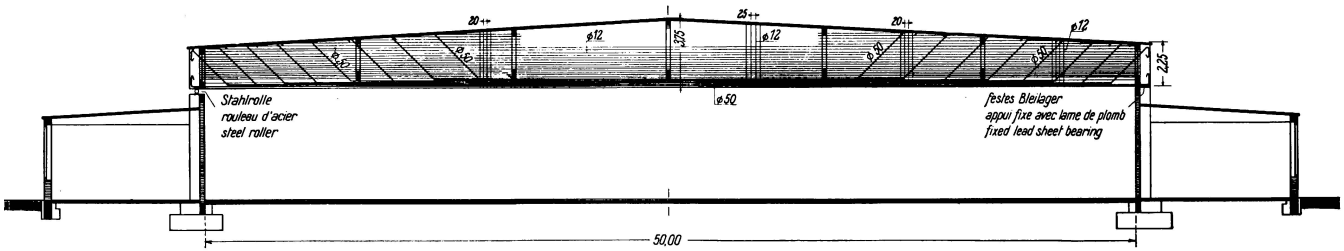

Fig. 8.

tie-bars and the scaffold had been completely struck. The displacement of the abutments during the operation amounted to less than 1 mm (an amount which was, of course, quite insignificant in a span of 100 m) and the extension of the tie-bars to 58 mm.

The pre-stressing of the tensile reinforcement in a member subject to bending which is to be concreted on the site constitutes a more difficult problem, and in recent years many proposals in this direction have been made. *Freyssinet* in his recent book «Une révolution dans les techniques du béton» describes a reinforced concrete girder which was pre-stressed so as to place all the steel in tension by the amount necessary to take up the thrust.⁵ The process is well conceived but takes up a good deal of time, and its economy does not appear to be established. Hitherto it has always been found that such proposals are difficult to carry out by the means available on the site, and it remains to be seen whether the future will bring a change in this respect.

Apart from the constructional devices described above, all necessary precautions must be observed to increase the tensile strength of the concrete and to make full provision against the formation of undesirable cracks. It is important to take all possible steps to secure a concrete of high tensile resistance, such as the choice of suitable cement and aggregates, careful concreting and after-treatment of the concrete.

No such wealth of experimental results is available for the tensile or bending tensile strength of concrete as for its compressive strength. For the present, therefore, we must be content with the broad generalisation that an increase in the tensile strength follows similar laws to that of compressive strength. In other words the stronger the concrete in tension the stronger it will be in compression, though the two strengths will not increase in the same proportion. It is not to be recommended that reinforced concrete structures of long span, which are exposed to bending stresses, should be made from concrete of the usual quality having an average compressive strength of perhaps 150 to 180 kg/cm², but if certainty against cracking is to be ensured the concrete must show a compressive strength of 250 to 300 kg/cm² or preferably more.

To obtain strengths of this order it is necessary to use cements of high quality (indeed of exceptionally high quality), giving the maximum possible tensile strength. They must also be so chosen as to cause a minimum amount of shrinkage, at any rate initially. Every technician knows that the liability of cement to shrinkage is very variable; there are some cements which give good results in this respect and others which have been found to shrink excessively. Unfortunately the use of this knowledge must remain a matter of hit and miss until more perfect methods of testing for shrinkage are developed and until cement manufacturers can be called upon to supply their customers with information not only of the fineness and as to the compressive strength that may be anticipated but also as to the shrinkage properties of their product.⁶

⁵ See also Volume 4 of the "Publications" of the I.A.B.St.E. and the "Preliminary Publication" of the Berlin Congress.

⁶ In this connection see also the present author's paper „Entwicklungsrichtungen im Eisenbetonbau“, Bautechnik, 1936, p. 141.

It should further be remembered that in accordance with the explanations given above the tensile bending stress in the concrete may be combined with the tensile stress arising from shrinkage, even though the latter may be reduced by the plastic deformation of the concrete. The amount of cement should, therefore, be liberally proportioned even at the risk of increasing the shrinkage, for the advantage of the greater strength of high quality cement outweighs the disadvantage of the increased shrinkage which may result from the larger cement content and from the greater fineness of the high quality cement.

The modulus of elasticity of concrete is subject to wide variations, depending mainly on the nature and proportions of the aggregates and binding material, the water content, the methods of working and after-treatment followed, as well as on the position and magnitude of the stress. Some detailed numerical data on this matter have been published by *Hummel*,⁷ who obtained the following figures for the elongation due to tensile bending of concretes prepared from different aggregates with an admixture of 350 kg of high quality cement per m³ and a slightly plastic consistency:

Aggregate	σ_{bz} kg/cm ²	Breaking values		Compressive strength kg/cm ²
		Specific elongation $1 \cdot 10^{-4}$	E kg/cm ²	
Red quartz porphyry . . .	48	2.94	163 000	479
Quarzite	49	2.89	169 000	483
Grey stone chippings . . .	50	2.66	188 000	485
Broken stone	44	1.98	222 000	488
Basalt chippings	48	1.93	249 000	555

With the same bending tensile strength of $\sigma_{bz} = 48$ kg/cm² the specific elongation at fracture of concrete made with red quartz porphyry is 2.94×10^{-4} and that of concrete made with basalt chippings only 1.93×10^{-4} . It is understandable that concrete with a larger value of ϵ and a smaller value of E may be less susceptible to cracking than a concrete with a smaller ϵ and a larger E, and it is important that the implications of these experiments should be applied in the selection of aggregates.

The arrangement and sections of the reinforcing bars also are important from the point of view of crack formation. The bars should be placed as far as possible apart, though this rule is difficult to follow in the case of wide span structures wherein the section of concrete has to be reduced to a minimum and where, therefore, a smaller number of larger bars must be used. In Germany it is customary to use round bars almost exclusively. A few years ago the Isteg steel was placed on the market, and it is possible that bars of this kind, or bars with protrusions, may contribute to a finer distribution of the cracks even if they do not increase the carrying capacity.

In roof trusses of long span it will frequently not be possible to dispense with construction joints, having regard to the working conditions in concreting and

⁷ „Beeinflussung der Betonestizität“ by Dr. Ing. A. *Hummel*, Zement, 1935, pages 665 following.

to the availability of suitable plant, the erection of scaffolding, etc. So far as possible such construction joints should be placed only in the compression zone of the concrete and should run at right angles to the direction of pressure. If it is impracticable to avoid their presence in the tension zone they will entail a reduction in the available concrete section and it is essential that this should be made up by "knitting" the concrete together across the gap by a large number of additional bars.

The concrete increases in strength during the first few weeks and months, so that the later it receives its full stress the better its quality and the greater the guarantee against the formation of cracks. It is important, in this connection, that the concrete should be protected from premature drying immediately after it has set, by covering it over and keeping it damp. A concrete which is permanently kept damp shrinks only a small amount or may even swell, and by this means the additional stresses due to shrinkage may be avoided during the period in question and for some time afterwards, the final shrinkage stresses being

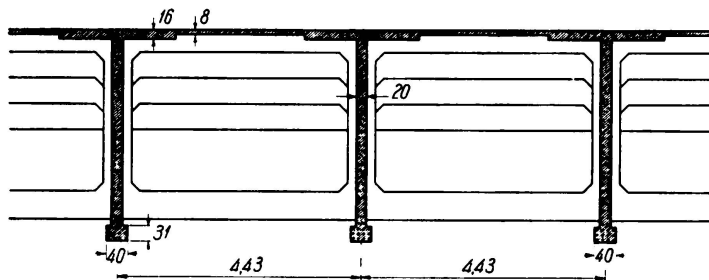

Fig. 9.

thus considerably reduced. It is also important to delay the removal of shuttering as long as possible, or if this cannot be done to provide temporary supports capable of carrying the whole weight of the structure.

In conclusion a description may be given of one more roof girder of large span which was built with due regard to the considerations mentioned above and has proved entirely successful.

The roof system shown in Figs. 8 and 9 covers a clear space of 50.0 m and consists of statically determinate girders on two supports with spans of 50.80 m. So far as the author knows, this is the first occasion that a structure of the type in question has been employed over so great a span. The spacing of the girder is 4.43 m and the roof covering is a reinforced concrete slab 8 cm thick. The latter is thickened to 16 cm over the girders in order to provide an adequate compression boom at these places. The cross bracing of the girders is provided by framed purlins at 8.40 m centres. The depth of the girder at the centre is 3.75 m and tapers to give a suitable fall to the roof being 2.25 m at the end. The thickness of the web is only 20 cm and in order to accommodate the tensile reinforcement the lower edge is thickened to 40 cm with a height of 31 cm. The bearing at the fixed end is on lead and that at the movable end on steel rollers.

The reinforcement of a girder is represented in Fig. 8 the tension bars being of 50 mm diameter and stressed up to a maximum of 1200 kg/cm². In addition to these and the vertical stirrups, which are 12 mm in diameter, longitudinal

reinforcing bars also of 12 mm diameter were provided in both the faces of the web with a view to preventing the formation of cracks. In the compression zone at the middle of the span it was possible to omit these, but at the two ends they were provided over the whole depth in order to co-operate with the bent-up longitudinal bars and the vertical stirrups in carrying the shear forces. In girders of this depth, so limited in thickness, special care is needed to ensure neatness and accuracy in arranging the steel according to plan.

The cement used was a high grade type supplied by the Thyssen works under the name of Novo, and the aggregate was made up of sand and quartz porphyry chippings. Test cubes made during the concreting operations showed compressive strengths of over 400 kg/cm² at 28 days. Special precautions were necessary in pouring the concrete in view of the large number of reinforcing bars and also because the Novo cement began to harden after a few hours in the warm summer temperature. These difficulties, however, were entirely over-

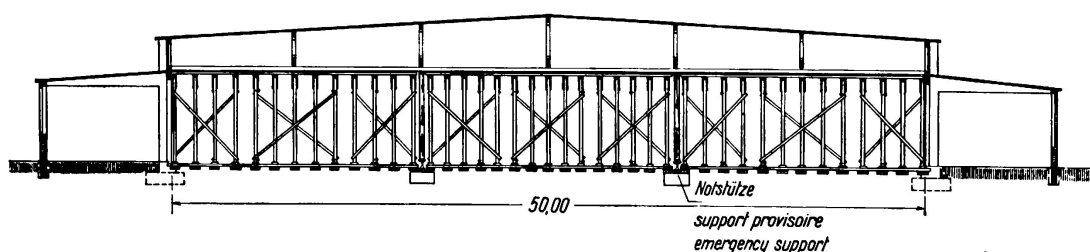

Fig. 10.

come with the result that all of the girders were concreted in such a way that on removal of the shuttering not a single cavity was found, nor did any bad place need to be patched.

To allow of the concrete being kept properly damp during the first few weeks provision was made for sprinkling it from water pipes close to either side of each girder, the pipes having small holes at 20 cm intervals through which the water was squirted against the sides of the girders. It was possible in this way to keep the concrete uniformly and continuously damp for about six weeks, after which the sprinkling had to be discontinued on account of the progress of other operations in the construction of the hall.

The shuttering for one of the girders is shown in Fig. 10, consisting of a simple framing of round scaffold poles arranged to transmit the load to the ground in the most direct way, but in view of the necessity for completing the floor as early as possible it was not feasible to allow these supports to remain in position as long as might have been wished. In order, therefore, to permit the shuttering to be struck from the girders as late as possible, temporary supports were provided in advance under the third points, each consisting of two heavy round timbers resting on screw jacks at the foot and capable of carrying the whole dead load of the girder. These temporary supports did not interfere with further building work of the hall — particularly of the floor — and they did not, therefore, have to be removed until about six weeks after concreting, whereas the other supports had had to be taken away after about three weeks.

The total deflection of the girders on the removal of the temporary supports amounted to about 5 cm at the middle, representing approximately $\frac{1}{1000}$ of the span, and in the course of years this deflection will increase to some extent on account of plasticity. To provide for this increase, and particularly with a view to good appearance, the lower boom of the girder has been given a camber of 24 cm on the centre line beforehand. All the work was carried out to perfection and none of the girders showed cracks of any kind.

Finally, it is proper to lay every emphasis on the fact that cracks which result merely from the tensile strength of the concrete having been exceeded, and which do not imply any structural defect such as insufficient steel reinforcement, are not dangerous to the work except in so far as they may allow rusting of the tensile reinforcing bars under load. Apart from this contingency such cracks have no significance, and in order to prevent the rusting of the bars it is sufficient that the cracks should be pressed out or covered over with a spray of cement grout, an elastic paint or an elastic compound after three or four years have elapsed and the shrinkage is approaching its final amount.

II b 3

Effect of Petrographical Properties of Aggregates on the Strength of Concrete.

Einfluß der petrographischen Eigenschaften der Zuschlagstoffe auf die Betonfestigkeit.

Influence des propriétés pétrographiques des matériaux additionnels sur la résistance des bétons.

Dr. Ing. A. Král,

Professor der techn. Fakultät an der Universität Ljubljana.

Arising out of the papers published in Section IIb of the Preliminary Publication of the Congress, it would appear useful to refer to some straightforward but characteristic series of experiments on concrete which have been carried out in the Materials Testing Laboratory of the Technical Faculty of the University of Ljubljana in Yugoslavia, with a view to closer investigation of the stone found in large quantities within the jurisdiction of the Banat of Drave, from the point of view of its suitability for making high quality concrete.

The district in question lies at the north west corner of the country and includes the eastern chains of the southern limestone mountains in addition to the northern or Carinthian region of the Dinaric Alps. From these orographical characteristics it will be at once apparent that the whole region contains mainly limestone with some dolomite. In the central Drave valley and in the transition to the eastern central mountains there exists, however, a fairly pronounced massif of foothills known as the Pohorje which consists mainly of primary rocks, and which in addition to some softer sedimentary rocks contains an excellent plutonic rock known as *Tonalite*, which is a special form of diorite and is typical of the boundary region between the central and southern alps. This rock differs from granite in having a smaller quartz content, varying between 16 and 31 %; its main constituent is plagioclase. The stone is uniformly of medium to fine grain and is well compacted.¹

In the alpine chains there occur porphyritic intrusions, notably *Keratophyr*, which are intermediate in quartz content between the granitic and syenitic groups, and are classed as magmatic rocks; these show a fine porphyritic structure. In the spurs of the alps which form the boundary of the Panon plain many veins and blocks of andesite occur; here again the main constituent is plagioclase with occasional grains of magnesite and volcanic glass. The structure varies from fine-grained to amorphous, and as a result of the low degree of crystallisation and of

¹ This and all the following mineralogical and petrographical details have been supplied through the great kindness of the Mineralogical-Petrographical Institute of the University of Ljubljana under Professor V. Nikitin.

the presence of the volcanic glass the stone is fairly brittle, but apart from this it must be regarded as a good material which is suitable for the purpose named.

In the past, use has been made not only of these local magmatic rocks but also of a basalt, found in the Lavan Valley of Carinthia in immediate proximity to the Yugoslav frontier, although in Austrian territory. The existence of favourable railway connections has made possible a fairly extensive use of this material in Yugoslav territory; the stone shows the usual characteristics of a material of normal quality, is very uniform, and has a fine grained structure.

These four kinds of magmatic rocks were the subject of the experiments mentioned above, and two further limestones and two dolomites were examined at the same time for purposes of comparison. The first of these limestones comes from the northern edge of the Carinthian region at Verd, south of Ljubljana; it is a palaeozoic material with a fairly high content of silicate admixtures. The second limestone comes from Trbovlje and belongs stratigraphically to the trias formation; it is mainly pure and contains only very small admixtures. The two dolomites also come from triassic strata in the foothills of the eastern alps, and differ only as regards their origins at Trbovlje and Senovo respectively.

The sand and small material obtained from these rocks was put together as far as possible in accordance with *Fuller's* sieve curve. In the tonalite, and in one series of tests with basalt, pure quartz sand of less than 1 mm gauge was added as a filler. High grade cement to the following specification was employed: —

At two days 27 kg/cm² tension, 377 kg/cm² compression.

At seven days 36 kg/cm² tension, 636 kg/cm² compression.

The test specimens were prepared in accordance with the Yugoslav standards using the *Tetmajer-Klebe* tamping apparatus.

The cement admixture of 400 kg/m³ of concrete was made with a water-cement ratio of 0.5; and the consistency was further controlled by the American slump method, in order to ensure the greatest possible uniformity of the concrete made with all kinds of stone.

From the wide range of experiments carried out with these materials, only the cube and bending strengths at 28 days are given below, in a graphical form for the sake of convenience in perusal. Despite the relatively small scope of the statistical data, the following conclusions may be drawn:

From the point of view of compressive strength no appreciable difference is disclosed between the concrete made with magmatic rock and that made with calcareous rock, most of the average values being 400 to 450 kg/cm² and the deviations from the average being for the most part less than 10%, or in many of the series of experiments inappreciable. The diagram of tensile strength is more instructive: the tensile strengths of concretes made with magmatic rock all lie close to the average value of 45 kg/cm², whereas it is clearly apparent in the case of the limestone groups that the tensile strength averages close to 55 kg/cm². Even the relatively large scattering of values for the bending strength here obtained cannot impair this interesting indication, and the minimum strengths in the calcareous groups are also noticeably higher than the maximum strengths in the magmatic groups.

A further interesting comparison may be made between the strength of the concrete made from the Verd limestone and that made from the Trbovlje

limestone. The whole of this region, the geography of which was explained at the beginning of this note, lies in the region of contact between the Alps and the Dinarides. Owing to the orogenetic processes which are known to have taken place there the earth's crust has been violently compressed, and this is clearly apparent in the microscopical structure of the rocks in question. They all show consequences of such pressure having been exerted in a variety of orientations, and throughout the region the cohesion of the stone depends to a large degree on whether this orogenetic pressure has been exerted on it from all sides at a great

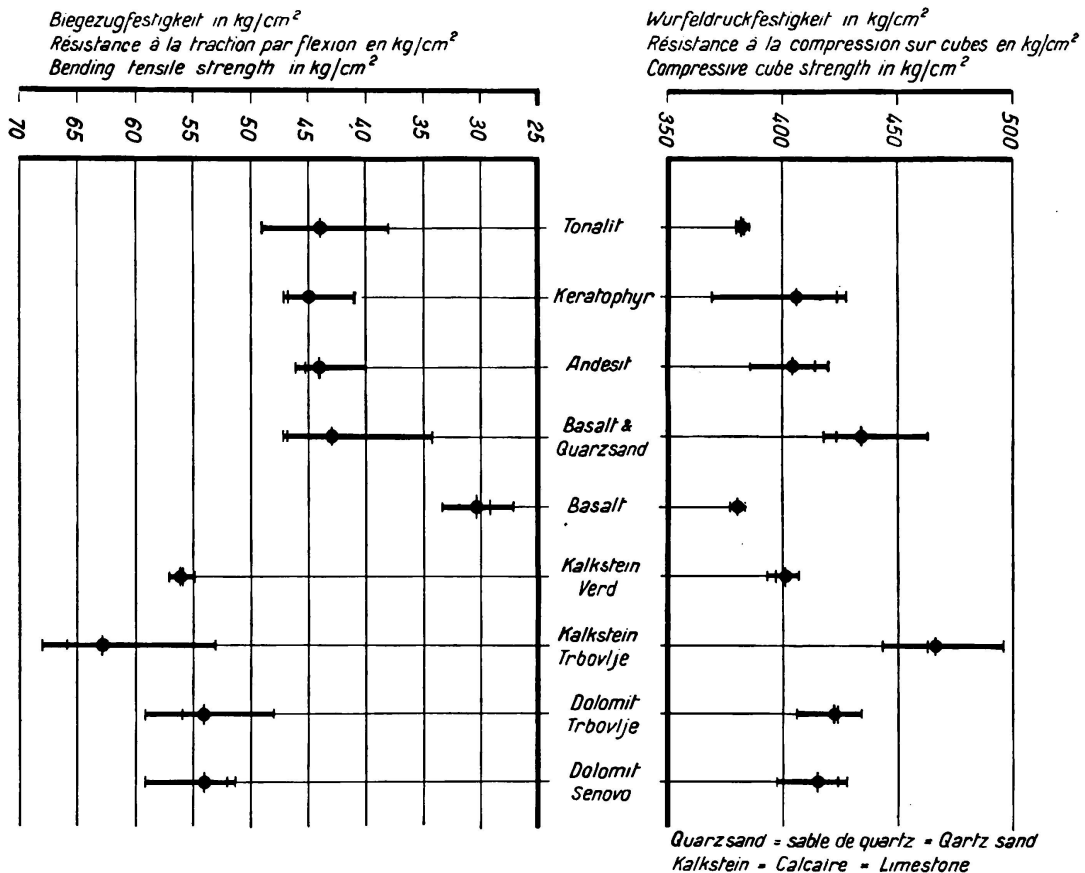

depth or whether, on the other hand, it has been the result of later infiltrations of calcite into the cracks and cleavages by a secondary process. The Verd limestone being older, and having clearly been produced in lower strata by pressure in addition to having undergone this secondary infiltration of calcite, is better bonded and much more uniform than the Trbovlje limestone, but on the other hand the latter is a good deal purer. This is the probable explanation of the higher strength obtained in the latter material and also of the greater scattering of values both for compressive and bending strengths. The diacase apparent in its micro-structure shows every sign of having been a further disturbing cause in the coherence of the concrete mass.

In spite of this lack of uniformity, it seems justifiable to conclude that calcareous rocks offer a higher degree of adherence for cement mortar than is afforded by the otherwise stronger magmatic rocks, and the result of this is a higher tensile (though not compressive) strength in the concrete for which they form the mineral skeleton.

IIb 4

Means of Increasing the Tensile Strength and Reducing Crack Formation in Concrete.

Mittel zur Erhöhung der Zugfestigkeit und zur Verminderung der Rissebildung im Beton.

Moyens d'augmenter la résistance à la traction et de diminuer la formation des fissures dans le béton.

M. Coyne,

Ingénieur en Chef des Ponts et Chaussées, Paris.

The writer has had occasion during the past few years to construct a large number of retaining walls of the following type: the face is entirely of masonry or of reinforced concrete of limited thickness, regardless of the height of the

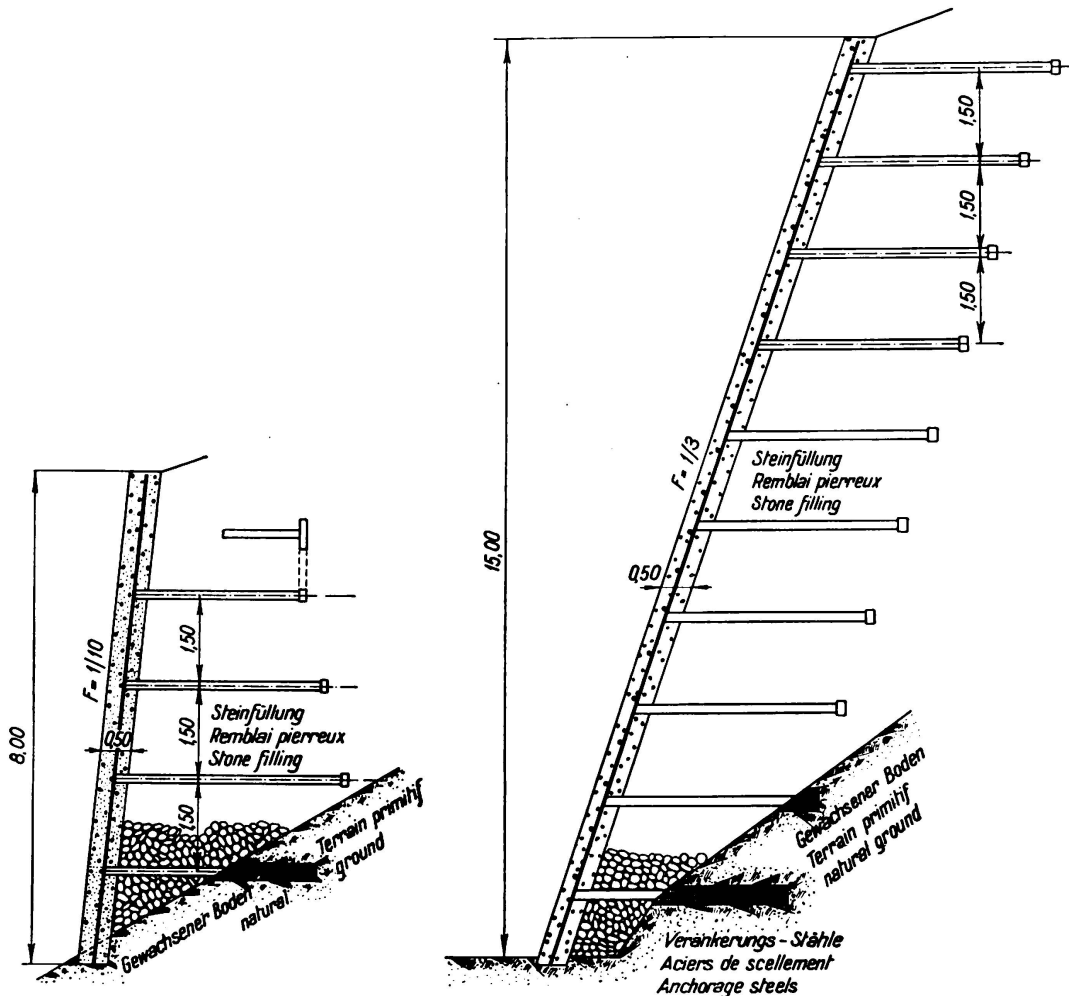

Fig. 1. Retaining walls on Coyne's ladder system — Cross sections.

wall, stability being obtained through the agency of relatively short tie-bars which are contained almost entirely within the prism of pressure.

An explanation of the mechanism whereby the stability of these structures is ensured will be found in an article in *Le Génie Civil* dated 29th October, 1927.



Fig. 2.

Retaining wall, ladder system (8 m high).



Fig. 3.

Retaining wall, ladder system (8 m high).

The name "ladder retaining walls" has been applied to them. A few examples are shown in Figs. 1, 2 and 3.

The construction of the tie-bars, which are of reinforced concrete, involves a special problem, in that the settlement of the ground causes the tie-bars to deflect, whereas as indicated in Fig. 4 the wall itself undergoes no settlement.

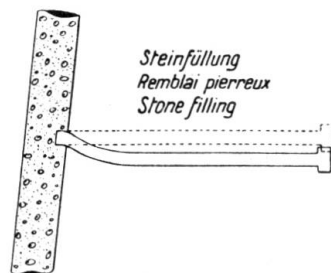

Fig. 4.

Diagram showing the bending of a tie bar due to settlement of the back-fill.

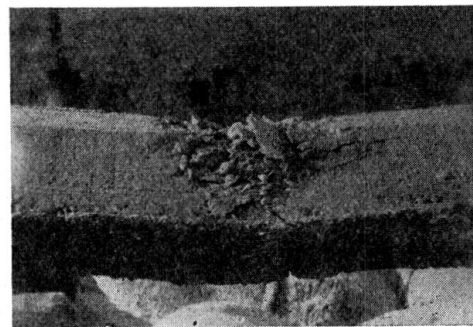

Fig. 5.

The concrete around the tie bar subjected to tension and bending develops cracks which expose the reinforcement to rusting, even though ordinary hooping steel is provided.

The concrete being thus subjected to tension in addition to bending is apt to crack and the steel is thereby exposed to corrosion (Fig. 5). The problem is to reduce this tendency to crack; hence the justification for mentioning the matter under the present heading. The solution is as follows:

The steel is situated at the centre of the tie-bar, and the concrete sleeve which encloses it is in turn surrounded by a steel hoop, the object of which is to pre-

vent or restrain the formation of cracks. If however, this hooping is done in the ordinary way it is useless, since a crack may be formed between successive turns

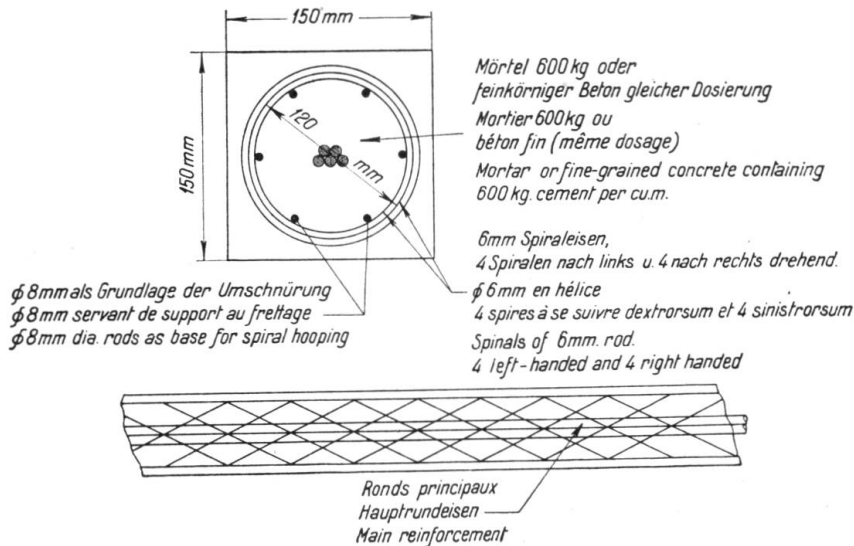

Fig. 6.

Tie bar with special hooping (of coarse pitch).

(Fig. 5). The turns must therefore be arranged in a spiral (Fig. 6) so that, firstly, the cracks are rendered discontinuous, and secondly, the longitudinal tension of the tie-bar is transformed by the agency of the spiral into a lateral

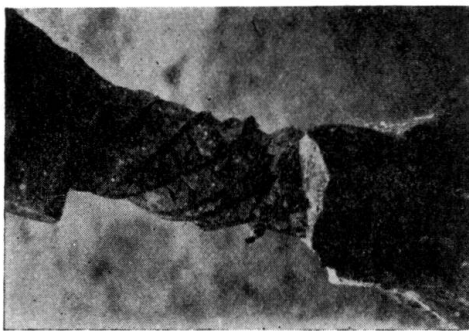

Fig. 7.

Tie bar with special hooping.



Fig. 8.

Tie bar with special hooping.

restraint. In this way tie-bars are formed which are capable of carrying very heavy bending moments without the concrete core suffering damage (Fig. 7 and 8).

This new method of forming *tensile* joints in reinforced concrete would doubtless be capable of many other applications also.

Leere Seite
Blank page
Page vide