

IIc. Use of high-tensile steel

Objektyp: **Group**

Zeitschrift: **IABSE congress report = Rapport du congrès AIPC = IVBH
Kongressbericht**

Band (Jahr): **2 (1936)**

PDF erstellt am: **21.07.2024**

Nutzungsbedingungen

Die ETH-Bibliothek ist Anbieterin der digitalisierten Zeitschriften. Sie besitzt keine Urheberrechte an den Inhalten der Zeitschriften. Die Rechte liegen in der Regel bei den Herausgebern.

Die auf der Plattform e-periodica veröffentlichten Dokumente stehen für nicht-kommerzielle Zwecke in Lehre und Forschung sowie für die private Nutzung frei zur Verfügung. Einzelne Dateien oder Ausdrucke aus diesem Angebot können zusammen mit diesen Nutzungsbedingungen und den korrekten Herkunftsbezeichnungen weitergegeben werden.

Das Veröffentlichen von Bildern in Print- und Online-Publikationen ist nur mit vorheriger Genehmigung der Rechteinhaber erlaubt. Die systematische Speicherung von Teilen des elektronischen Angebots auf anderen Servern bedarf ebenfalls des schriftlichen Einverständnisses der Rechteinhaber.

Haftungsausschluss

Alle Angaben erfolgen ohne Gewähr für Vollständigkeit oder Richtigkeit. Es wird keine Haftung übernommen für Schäden durch die Verwendung von Informationen aus diesem Online-Angebot oder durch das Fehlen von Informationen. Dies gilt auch für Inhalte Dritter, die über dieses Angebot zugänglich sind.

II c

Use of high-tensile steel.

Anwendung von hochwertigem Stahl.

Utilisation des aciers à haute résistance.

Leere Seite
Blank page
Page vide

IIc 1

Examples of the Application of High Tensile Steel in Reinforced Concrete Slabs.

Beispiele für die Anwendung von hochwertigem Baustahl bei Plattenträgern aus Eisenbeton.

Exemples d'application de l'acier à haute résistance dans les systèmes en dalles de béton armé.

Dr. Ing. H. Olsen,
München.

Hitherto the development of reinforced concrete construction in bridges has been concerned almost exclusively with the design of arch and beam bridges, but in view of the great improvement attained in the mechanical properties of concrete, the production of a structural steel of high yield point, and the endeavours now being made to utilise these two high-grade materials consistently, further constructional development of the slab girder is to be anticipated. This is a type of structure with the merit of clear and simple statical conditions, because as a rule the bending moments are in one direction only, while moreover the shuttering work, the arrangement of the reinforcement, and the placing of the concrete are all notably simplified. Again, slab shaped members, in consequence of the great width of the concrete in the tension zone, show much greater freedom from cracking than is the case with the shallow ribs of T-beams.

The structural possibilities of slab girders when account is taken of the increased permissible stresses will be illustrated here in a few practical examples. The bridges in question were designed by the author and were completed as part of the work on the eastern section of the German Alpine Road in the spring and summer of 1936.

Fig. 1 shows a reinforced concrete slab designed as a *Gerber* girder over three openings of 12.4 m span each, with a roadway width of 8.5 m. The piers and abutments make a wide angle with the axis of the road. The thickness of the slab, only 0.60 m at the side and 0.68 m at the axis of the road, shows the extent that the constructional depth can be reduced through the use of high-grade materials. In the present case the proportion of the mix was 300 kg of ordinary Portland cement per cubic metre, and at 28 days the cube strength of the concrete was 405 and 513 kg/cm², allowing a permissible compressive stress in the concrete up to 70 kg/cm², while the permissible stress in the steel in the round bars of St. 62 was taken as 1500 kg/cm². Loading was assumed in accordance with the German regulations for Class I bridges, including a 24 tonne steam

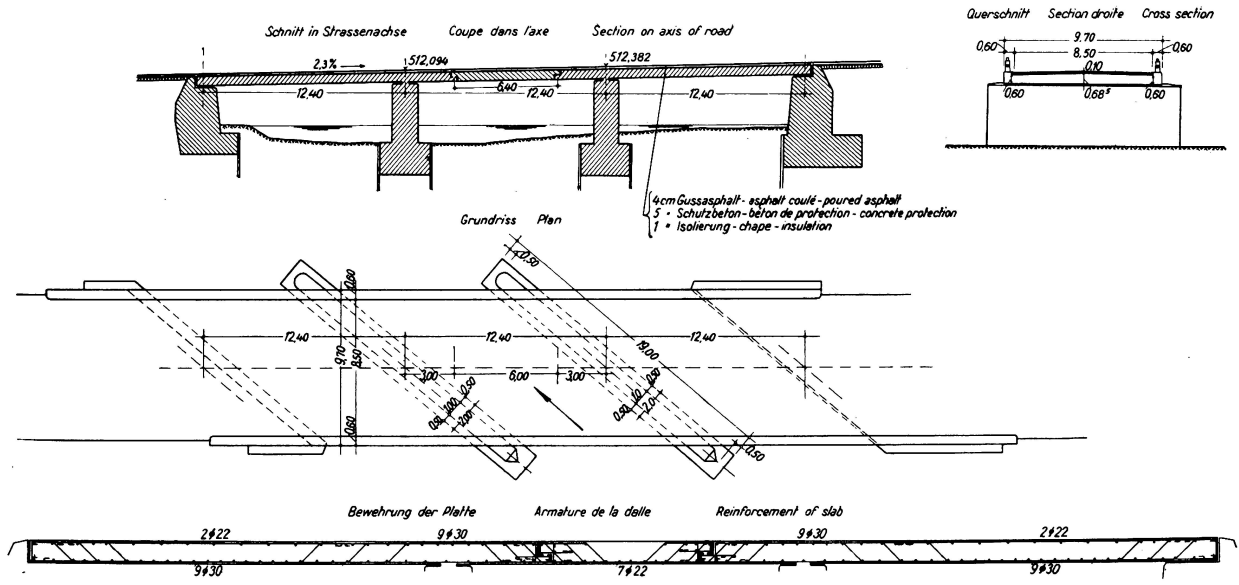

Fig. 1.
Weissbach Bridge II.

roller and a 12 tonne motor lorry uniformly distributed over two lanes of traffic totalling 5.0 m in width, with an impact coefficient of 1.4.

The reinforcement in the direction of the length of the bridge is shown in Fig. 1. With a maximum moment of 51.7 mt/m at the centre of the outside spans and of 60.3 mt/m over the supports, and taking $\sigma = 70/1500 \text{ kg/cm}^2$, the design provides nine round bars of 30 mm diameter in each unit of width over the supports. The suspended slab in the central field, which is 6.4 m long and receives a maximum moment of 20.3 mt/m with $\sigma = 42/1500 \text{ kg/cm}^2$, is reinforced with seven round bars of 22 mm diameter.



Fig. 2.

Fig. 2 shows the flowing lines in which the bridge crosses the river. The adoption of a timber railing on reinforced concrete posts notably improves the architectural unity of the structure, and this railing runs into massive parapets carried on the wing walls.

Fig. 3 shows another reinforced concrete slab built as a *Gerber* girder over three openings, each of 11.5 m span, with a road width of 8.5 metres. In this case again the two piers and the abutments are askew with the axis of the road. The roadway slab is cambered at 1.5 % and is uniformly 60 cm thick.

Here again the slab was reinforced with round bars of St. 62 subject to a stress of 1800 kg/cm^2 . This stress was justified, among other factors, by the conclusion drawn from the Dresden experiments that such slabs possess notably greater safety against cracking than T-beams, and also by adequate safety against breakage. In the Stuttgart fatigue tests on high tensile steel the further conclusion was drawn that a permissible stress in the steel of 1800 kg/cm^2 is suitable in slabs, even under moving loads, in cases where the concrete shows a cube strength of not less than 225 kg/cm^2 .

The reinforcement required to resist the standard loading for Class I bridges is shown in Fig. 3. With a maximum moment of 47 mt at the centre of the outside spans and of 45.5 mt over the supports, seven round bars of 13 mm diameter were adopted, the stresses in the cross sections being then respectively

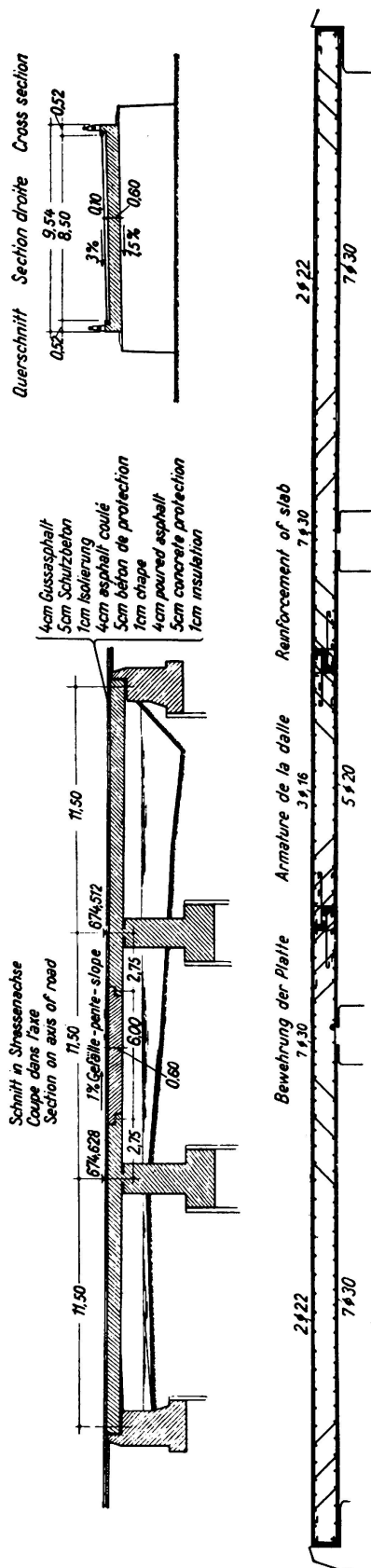

Fig. 3.

Traun Bridge Hinterpoint.

$\sigma = 74/1800$ and $71/1680 \text{ kg/cm}^2$. The suspended slab in the central field is of 6.0 m span, and under a maximum moment of 18.8 mt requires five round reinforcing bars of 20 mm diameter for $\sigma = 77/1800 \text{ kg/cm}^2$. The cube strength of the concrete made with 300 kg of ordinary Portland cement per cu. metre was 661 kg/cm^2 at 28 days. This exceptionally high cube strength indicates — as do the cube strengths mentioned above — the particular care with which the concreting of bridges on the German Alpine Road has been carried out. In view of this circumstance the adoption of reinforcing steel of 30 mm diameter was permitted, and provision was made for its firm anchorage in the concrete by means of suitable end hooks.

Fig. 4 shows how well this bridge merges into the surrounding landscape.

By the adoption of framed designs of slab girders it is possible considerably to reduce the constructional depth. Fig. 5 shows a two-hinged slab frame of 10.6 m span with an average depth of 3.25 m. The thickness of the slab of the lintel portion varies from 0.33 m at the side to 0.46 m on the centre line, and the thickness of the side members is 0.60 m. The frame was reinforced with round bars of St. 52 and once again a stress of 1800 kg/cm^2 was adopted.

Fig. 6 shows the reinforcement of the frame with a maximum moment at the centre of the lintel amounting to 17.9 mt/m, combined with the normal force of 5.5 tonnes, the necessary reinforcement, assuming permissible stresses of $\sigma = 75/1800 \text{ kg/cm}^2$, being ten round bars of 20 mm diameter. The fixing of the lintel into the vertical members is calculated for a maximum moment of — 21 mt/m, and taking $\sigma = 50/1800 \text{ kg/cm}^2$, eight round bars of 20 mm in diameter are necessary. In the upper portion of the verticals, with $\sigma = 1800 \text{ kg/cm}^2$, the necessary reinforcement is seven round bars of 20 mm diameter, and in the middle of the verticals four round bars of that diameter.

Fig. 7 shows the finished bridge, the external lines of which are derived directly from the statical conditions.

By making proper use of the mechanical properties peculiar to high-grade concrete, it becomes possible to construct slab bridges even over large spans, and at the same time the amount of steel required can be much reduced by adopting

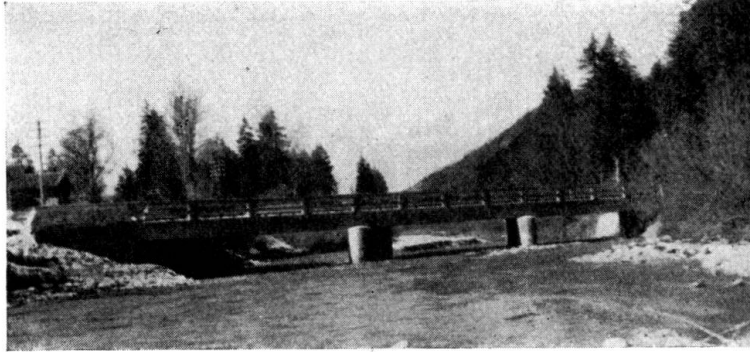

Fig. 4.

high tensile steel and taking advantage of the increased permissible stress therein.

The bridges just described are the first in Germany in which permissible stress in the steel of 1800 kg/cm² has been adopted; this figure exceeds what is

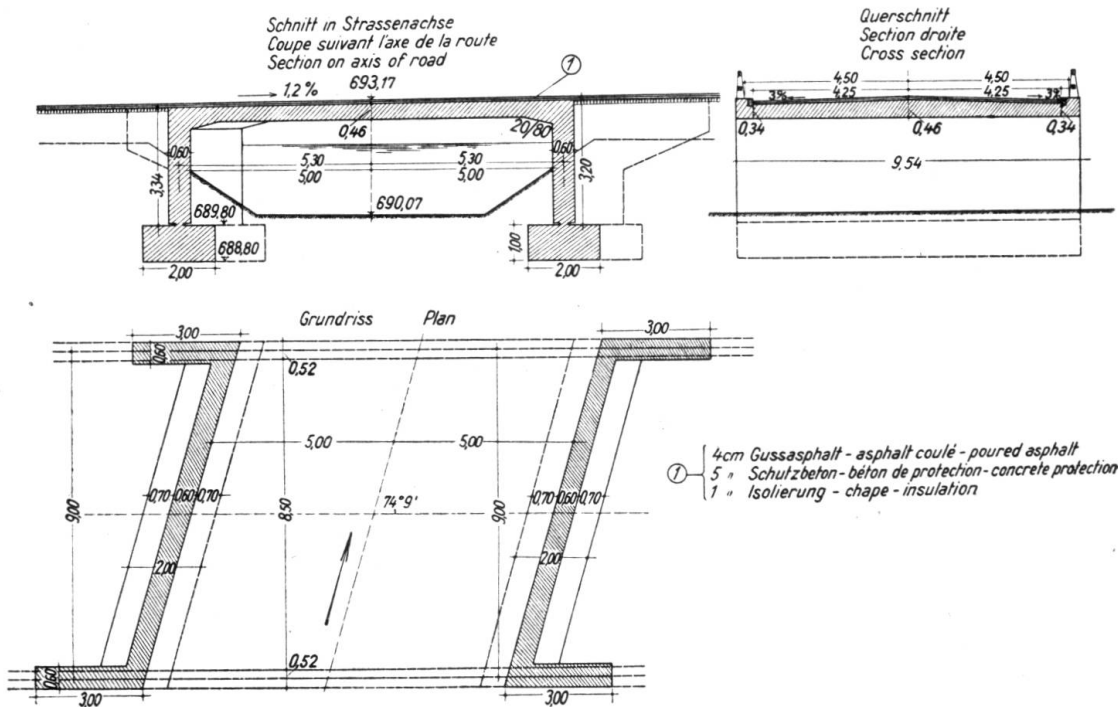

Fig. 5.

Bridge over Grosswaldbach.

allowed by the current regulations, but in view of the knowledge now made available by the testing laboratories its adoption was held to be justified. Moreover the peculiar mechanical properties of high tensile structural steel are

confirmed by practical experience in actual work, particularly by the excellent performance noted after six months service under heavy traffic.

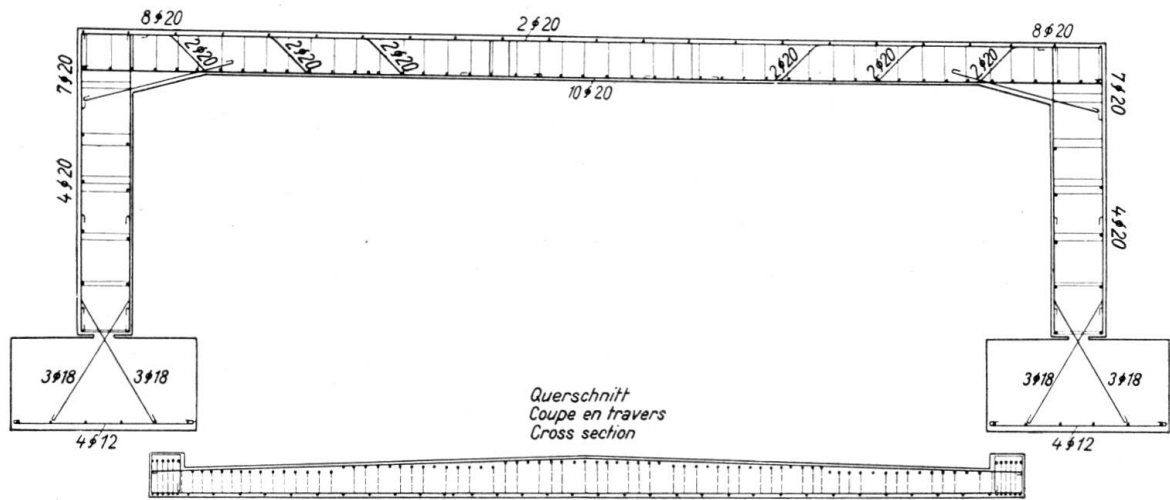

Fig. 6.

Reinforcement of frame.

It may be deduced from these descriptions of structures that slab girders are in fact a method of construction which offers scope for development. Seeing that the scantlings, and therefore the "own weights" of the structure, depend on

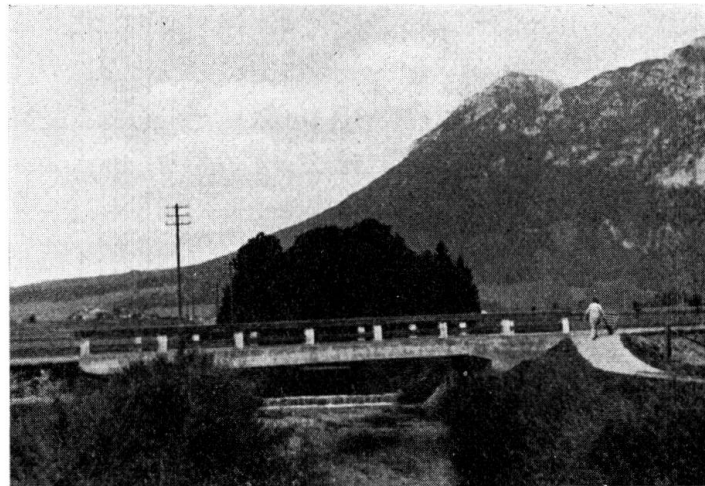

Fig. 7.

the magnitude of the permissible stresses the question arises what is the maximum span to which bridges of this type can be built with constructional and economic advantage; the answer to this depends, above all, on improving the qualities of high-grade concrete and high tensile steel.

II c 2

The Welding of „Roxor“ High Tensile Steel.

Das Schweißen von hochwertiger Stahlbewehrung „Roxor“.

Le soudage de l'acier à haute résistance „Roxor“.

A. Brebera,

Ingenieur, Obersektionsrat im Ministerium für öffentliche Arbeiten, Prag.

The introduction of the “Roxor”¹ high tensile steel represents a great advance in reinforced concrete construction, and its use as reinforcement for high strength concrete has made it possible to erect reinforced concrete structures of so large a span that the usual length of the bars has frequently to be exceeded. It follows, therefore, that in any large structure of this kind a large number of joints have to be provided in the reinforcing bars.

Hitherto it has been customary to make such joints by the simple process of allowing the bars to overlap over a certain length, but if a joint of that kind is to be made completely effective it is essential that the bars should be completely embedded in concrete, which entails an increased distance between them with the result that the width of the beam has to be increased accordingly. According to the official specifications it is not permissible to allow bars to overlap of more than 32 mm diam., and this places a limit on the span of the structures which can be built.

Hence the necessity to find some other type of joint which would allow of the ends of the two bars being completely bonded together over the whole of their cross sections without any weakening, and the only satisfactory solution to this important problem is that of welding the bars. Most of the existing regulations for welded work apply only to ordinary qualities of steel, and as no regulations were available for the welding of high tensile steels such as “Roxor” the problem had to be studied from first principles.

“Roxor” high tensile steel is made by slightly increasing the carbon content above that of the ordinary steel C 37 (maximum 0.22 % C), which is done by introducing certain elements such as silicon (maximum 0.90 % Si), manganese (maximum 0.50 % Mn) and copper (maximum 0.50 % Cu). The amounts of sulphur and phosphorus remain the same. The following are the mechanical properties of “Roxor” steel produced in this way.

Minimum yield point	38 kg/mm ²
Minimum tensile strength	50 kg/mm ²
Minimum elongation	20 %.

¹ Preliminary Publication, page 240.

In the welding of "Roxor" steel, the choice of electrodes plays a very important part, as it is necessary that the weld metal should be of the same quality as the parent metal. To ensure this, "Arcos-Superend" electrodes were adopted, the yield point, tensile strength, elongation and tenacity of these having been determined in accordance with the special regulations for the welding of metal bridges issued by the Ministry of Public Works. The results of these tests are given in Table I:

Table I.

Tests of weld metal deposited by "Arcos-Superend" electrodes.

	Minimum	Average	Maximum
Yield point	40.7	49.7	56.4 kg/mm ²
Tensile strength	50.7	57.0	63.3 kg/mm ²
Elongation (gauge length = 5 diameters)	18.0	19.5	20.4 %
Reduction in area	29.9	39.2	50.1 %
Tenacity (Mesnager)	5.0	6.6	7.9 mkg/cm ²

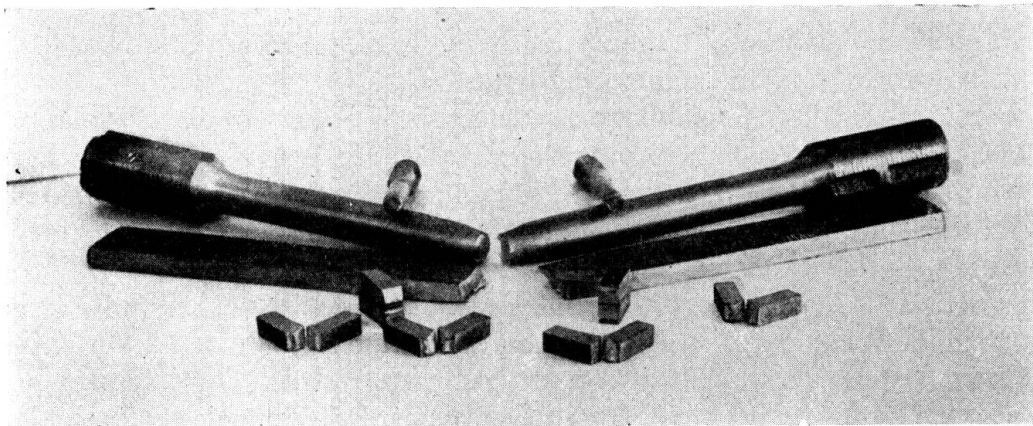

Fig. 1.

Tests of parent metal.

These figures indicate a quality of weld metal which, when deposited between two sheets of "Roxor" steel having the characteristics given in Table II below, will be the same as that of the parent metal (Fig. 1).

Table II.

Tests on "Roxor" steel.

	Average	Specified
Yield point	41.7	38 kg/mm ²
Tensile strength	58.5	50 kg/mm ²
Elongation (gauge length = 10 diameters)	22.6	20 %
Reduction in area	53.7	— %
Tenacity (Mesnager)	11.0	— mkg/cm ²

In addition to the tests on the electrodes, the tensile strength of the weld produced by them was tested on specimens consisting of two "Roxor" steel plates 12 mm thick joined by a weld at right angles to the direction of rolling (Fig. 2); the angle of folding and elongation of the extreme fibres of the weld

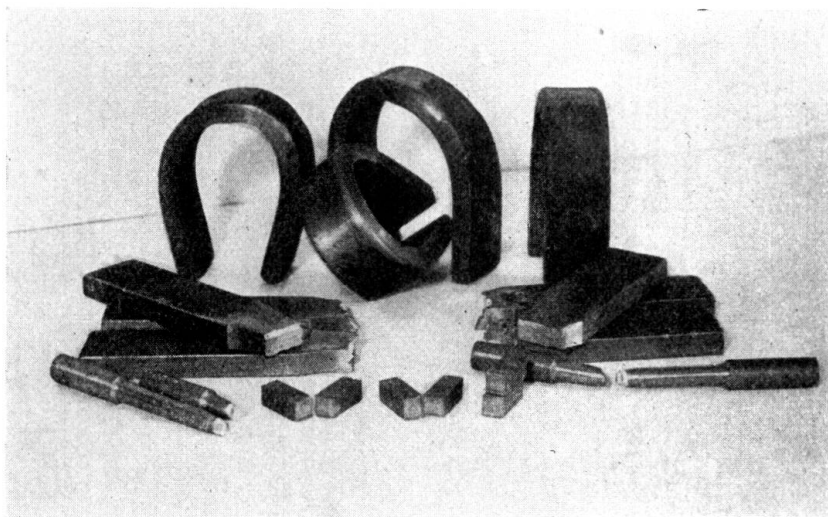

Fig. 2.

Tests of welds.

were also tested, giving results which were used as a check on the welders. The results are given in Table III:

Table III.

Tests on welded "Roxor" plates.

	Minimum	Average	Maximum
Tensile strength	50.5	59.8	65.7 kg/mm ²
Folding angle	180 ⁰	180 ⁰	180 ⁰
Elongation of extreme fibres	16.0	18.8	22.0 %

These tests were followed by the welding of "Roxor" reinforcing bars, which are of cruciform section with ribs to improve the adhesion. The welding tests were carried out on "Roxor" bars of 60 mm diameter (circumscribed circle), which is a size frequently used in long span bridges. The ends of the bars to be joined were first bevelled, then held in a special form of clamp (Fig. 3) while being welded with a V — seam using the "Arcos-Superend" electrodes (Fig. 4).

The results of all the tests carried out on welded "Roxor" bars are shown graphically in Fig. 5. It should be noticed that the welds were not machined. The average values obtained in the tests, together with the maxima and minima, are given in Table IV. In every case breakage of the bar took place outside the weld.

Table IV.

Tests on welded "Roxor" bars:

	Minimum	Average	Maximum
Yield point	39.4	40.1	40.6 kg/mm ²
Tensile strength	55.7	57.4	58.5 kg/mm ²
Elongation (gauge length = $11.3 \sqrt{A}$ [A = area]) . .	22.8	26.1	28.5 %
Reduction in area	33.8	47.9	51.4 %
Folding angle	180°	180°	180°
Elongation of the extreme fibres	6.2	10.3	12.1 %

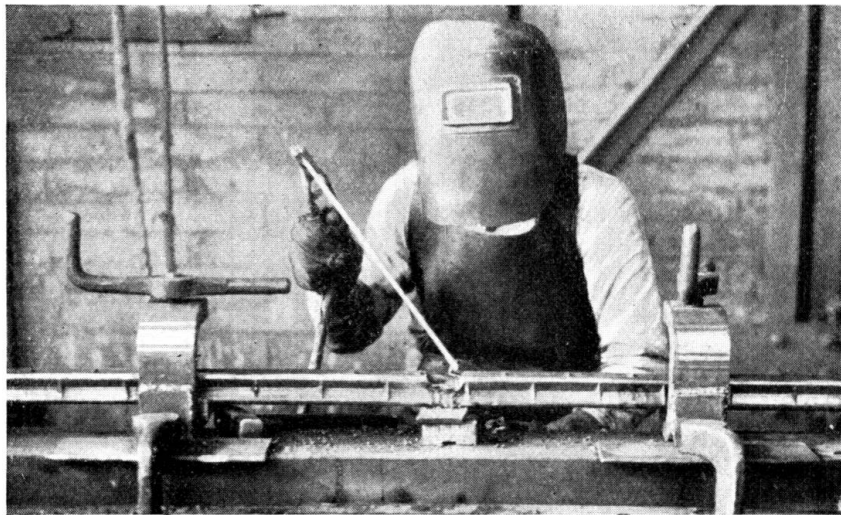

Fig. 3. "Roxor" bar ready for welding.

Test bars measuring $2 \times 1.25 = 2.50$ m in length were adopted in order that when the "Roxor" bars were applied in an actual job the heat should not spread

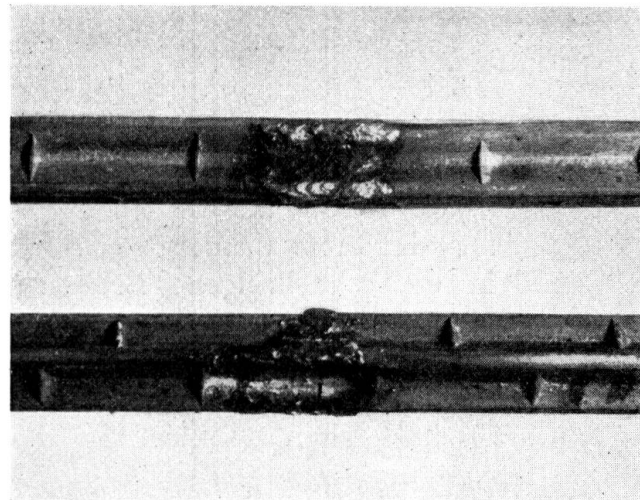

Fig. 4.
Welded
"Roxor" bars.

more rapidly than in the tests, as would have been the case if the usual small sized specimens had been used. It was ascertained, in the course of welding,

that the heating of the bars did not extend beyond 0.50 m from the weld, a result which may be attributed to the large cross section of the specimens (17.34 cm^2).

In addition to the tensile tests the "Roxor" welded bars were subjected in cold bending tests (Fig. 6), and the results of these were found to be in accordance with the specifications. To determine the elongation of the extreme fibres, and the effectiveness of the bond with the parent metal, a few of the bars were machined in the neighbourhood of the weld before testing, and the results so obtained are included in Table IV. The internal diameter of the bend is equal to five times (or occasionally six times) the diameter of the "Roxor" bar.

Figs. 7 and 8 are macroscopic and microscopic views of the longitudinal sections of a 60 mm "Roxor" welded bar. Fig. 7 shows part of the band of

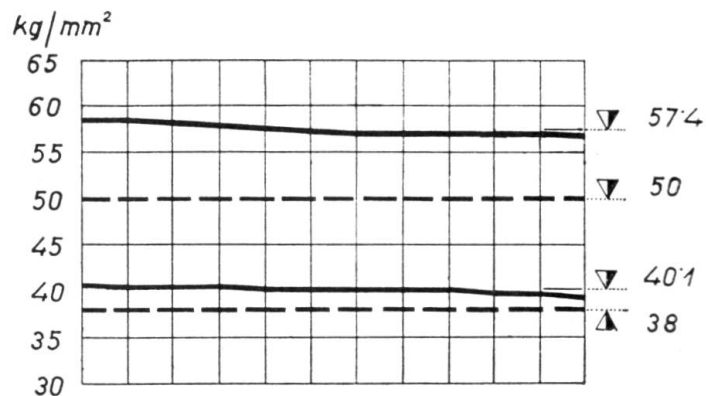

Fig. 5.

Results of tensile tests on welded "Roxor" bars, showing tensile strength and apparent elastic limit in kg/mm.

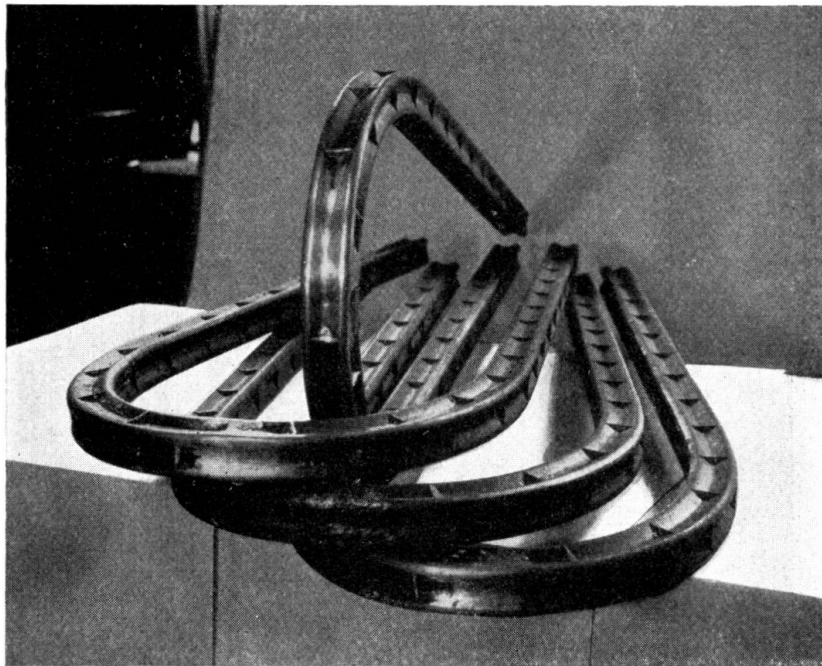

Fig. 6.

Bending tests of "Roxor" bars.

recrystallised metal between the weld metal and the parent metal. The crystals of sulphur and phosphorus are uniformly distributed in the parent metal without forming a coagulation, and the weld itself is completely free from such crystals.

The white crystals appearing in Fig. 8 practically all consist of pure iron (ferrite) and the dark spots around them are perlite (ferrite plus cementite, $F_{e_3}C$). The

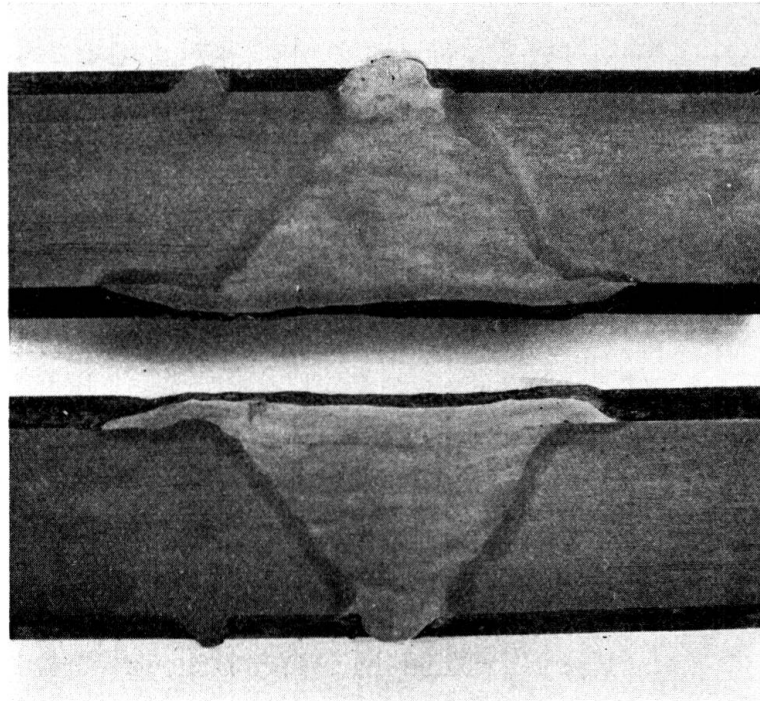
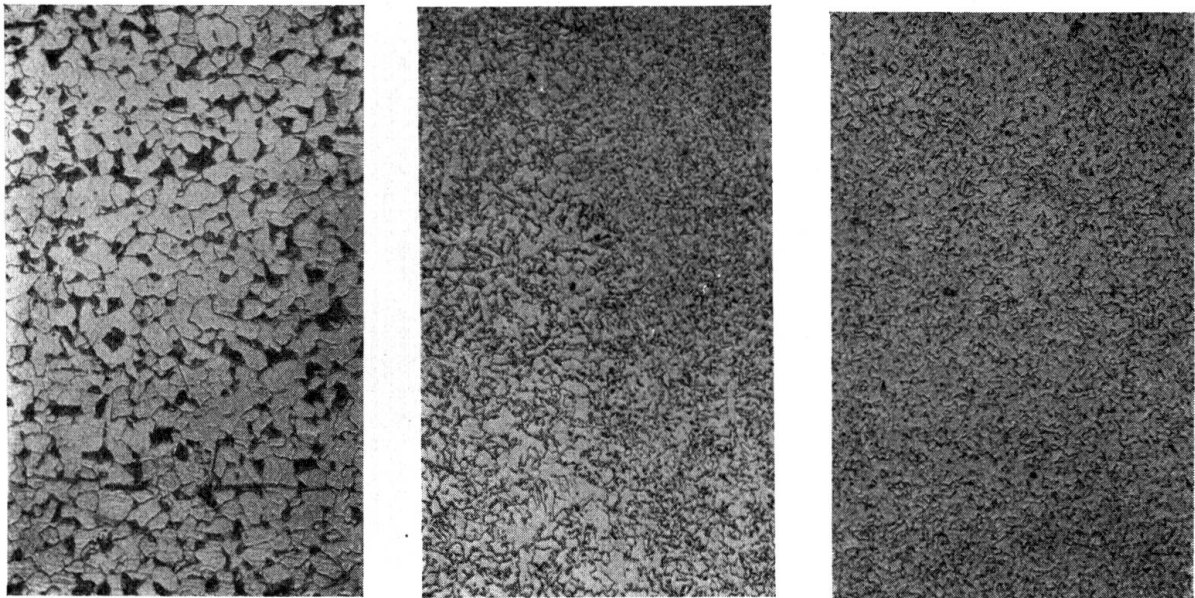

Fig. 7.

Etched and polished longitudinal section through a welded "Roxor" bar.

structure of "Roxor" steel is characterised by the presence of small uniform grains of ferrite, and the good mechanical properties are a consequence of this.



Parent metal

Transition zone

Weld metal

Fig. 8. Structure of welded "Roxor" bar, $\times 100$.

In the transition zone, the structure varies uniformly and changes into a completely regular fine-grained ferrite structure, the transition from the parent metal to the weld metal being imperceptible. The modification undergone by the parent metal as a result of welding was determined by the Brinell test, using a ball of 10 mm diameter under a pressure of 3000 kg (Fig. 9), which gave the following results.

Diameter of indentation < 4.80 mm : $P = 0.345 H$

Diameter of indentation > 4.80 mm : $P = 0.342 H$

where P is the tensile strength in kg/mm^2 and H is the Brinell hardness in kg/mm^2 . It may be seen from Table V, which gives the results of these ex-

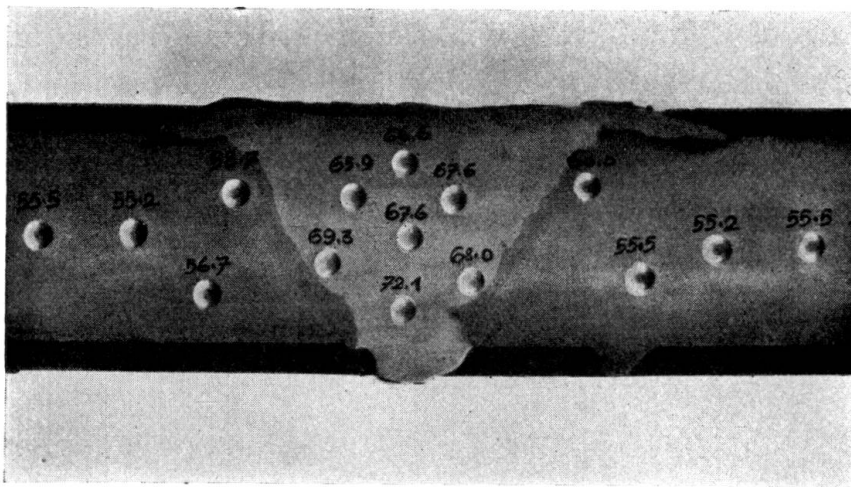

Fig. 9.

Brinell test on a welded "Roxor" bar.

periments, that the hardness of the unmodified parent metal corresponds to its tensile strength as determined in the breaking tests, whereas in the transition zones an increase in the hardness of the metal in relation to the change of structure is observed, this being brought about by the heat developed by the electric arc. The hardness of the metal increases as the structure of the weld becomes finer. This explains the small elongation of the weld (average 10.3 %) by comparison with that of the bars (average 26.1 %).

Table V.

Effect of welding on "Roxor" steel.

Tensile strength —

Of the parent metal (kg/mm^2):

55.5 55.2 56.7 55.5 55.2 55.5 Average 55.7

Of the metal in the transition zone (kg/mm^2):

58.7 69.3 68.0 60.0 Average 65.9

Of the weld metal (kg/mm^2):

65.9 66.6 72.1 67.6 67.6 Average 67.0

These favourable test results justify acceptance of the principle that welded joints may be formed in the "Roxor" bars without detriment to the factor of safety prescribed for unjointed bars, and for the purpose of calculation the cross section of a welded "Roxor" bar may be taken as unimpaired even in the neighbourhood of the joint.

The welding of "Roxor" bars must be carried out only by officially authorised welders and only by the use of "Arcos-Superend" electrodes as adopted in the tests; new tests would be necessary before other electrodes could be used. In order to avoid distortion of the welded bars as a result of the great shrinkage which takes place at the surface of the V-seam, it is recommended that a slight clearance should be allowed when fixing the bars in the clamp.

An incidental outcome of these tests was the acquisition of knowledge regarding the behaviour of other high tensile steels when welded, as, for instance, steel C 52.

IIc 3

High Tensile Steel in Reinforced Concrete Structures.

Verwendung des hochwertigen Stahls in Eisenbeton-Konstruktionen.

Les aciers à haute résistance dans les constructions de béton armé.

Dr. Ing. A. Chmielowiec.

Lwów, Pologne.

According to the regulations in force in various countries the permissible stress of mild steel such as is ordinarily used in the reinforcement of concrete amounts to 1200 kg/cm², and that of high tensile steel to 1800 kg/cm². The cross section of the tensile reinforcement may, therefore, be reduced by one third if the "1800" or high tensile steel is adopted instead of the "1200" or ordinary mild steel, without altering the depth of the beam. This involves a slight increase in the compression of the concrete, but this is always permissible as *Saliger* has shown in his paper N^o II c 3 before the present Congress. If, then, it is desired to replace n round bars of diameter d of mild steel by n_1 round bars of diameter d_1 of steel "1800" we obtain —

$$n d^2 \pi \cdot 1200 = n_1 d_1^2 \pi \cdot 1800$$

It is desired that the adhesion stress should remain the same in both cases, therefore

$$n d \pi = n_1 d_1 \pi$$

The above equations give the condition

$$n : n_1 = d_1 : d = 1200 : 1800 = 2 : 3$$

It follows that we can, for instance, replace two bars of 9 mm diameter of steel "1200" by three bars of 6 mm diameter of steel "1800". This entails very thin bars, which are expensive and which are not stiff enough to retain their straightness.

These disadvantages may be avoided by giving the reinforcing bars a regular triangular section. Of all the possible regular polygons of equal area, the triangle is the one which has the largest perimeter and the circle is the one which has the smallest. If d is the diameter of the circle and $a = 1.1 d$ is the side of an equilateral triangle, then the perimeter of the triangle is $3 a = 3.3 d$ and that of the circle is $\pi d = 3.14 d$, and the difference between

them is $3a - 3d = 0.16d$. Thus the perimeter of the triangle is 5% greater than that of the circle.

The area of the circle is $A_o = \frac{d^2\pi}{4}$ and that of the triangle is $A_\Delta = a^2 \frac{\sqrt{3}}{4}$

$$\text{Hence} \quad \frac{A_o}{A_\Delta} = \frac{d^2\pi}{a^2\sqrt{3}} = \frac{\pi}{1.21\sqrt{3}} = 1.5 = \frac{1800}{1200}$$

Thus a round bar of diameter d of steel "1200" may be replaced by a triangular bar of steel "1800" if the side of the triangle is $1.1d$. This gives a saving of 33% of steel without reducing the bond.

It would, therefore, be advantageous to adopt bars of steel "1800" of triangular section, and if the rolling of such sections were decided upon the following advantages would also accrue:

1) The danger of confusion between round bars of steel "1800" and those of steel "1200" would be eliminated.

2) Of all regular figures of equal area, the triangle has the largest moment of inertia and the circle has the smallest. (Figures bounded by perimeters containing re-entrant angles or concave curves, such as for instance a star, are here not considered. A bar of which the section is shaped like a star can be drawn out of the concrete within a cylindrical space which has no concavity, this cylinder being the smallest that can be circumscribed around the star in question.) The area of the circle being $A_o = \frac{d^2\pi}{4}$ the corresponding moment

of inertia will be $I_o = A_o \frac{d^2}{16}$. The area of the triangle being $A_\Delta = a^2 \frac{\sqrt{3}}{4}$ its

corresponding moment of inertia will be $I_\Delta = A_\Delta \frac{a^2}{24}$.

From the equation $A_o = A_\Delta$ we have $\frac{a^2}{d^2} = \frac{\pi}{\sqrt{3}}$

$$\text{whence} \quad \frac{I_\Delta}{I_o} = \frac{2a^2}{3d^2} = \frac{2\pi}{3\sqrt{3}} = 1.21.$$

Thus the moment of inertia of the triangle is 21% greater than that of the circle having the same area. Triangular bars are therefore more rigid than round bars and are not as easy to curve and bend, but retain their straightness better in course of handling, both in the store and on the site. This is a matter of some importance, for curved bars must straighten themselves before they can begin to act in tension, and meanwhile those bars which are already straight are overworked. In the case of compression reinforcement the stiffness of the bars is still more important, and round bars not being very rigid tend to buckle easily. There is, therefore, no object in using round bars of steel "1800" in compression.

3) Triangular bars take up less room in the store than round bars because they fill the whole of any given space without wastage: six triangles form

a regular hexagon, and such hexagons may be stacked closely against one another without losing any space.

4) A triangular bar can easily be twisted so as to obtain a special shape as in Ransome's system. In this way the grip between the bar and the concrete may be still further improved, seeing that the circumference of the circle enclosing the regular triangle is 21 % greater than the perimeter of the triangle itself. A twisted bar cannot be pulled out of the concrete without first having to strip the latter from the cylindrical surface circumscribing the bar, or from a surface which is still larger. This has been shown by experiments on Isteg steel. In such experiments at Warsaw, carried out by *Bryla* and *Huber*, two round bars of 7 mm diameter twisted into a spiral around one another gave an adhesion 20 % greater than a single equivalent round bar of 12 mm diameter. The circle circumscribed around the two twisted bars each 7 mm in diameter is itself of 14 mm diameter, and its circumference is, therefore, 16.67 % greater than that of the round bars. The difference of 20—16.67 % is attributable to the fact that the imaginary tube enclosing the twisted Isteg is a little larger than twice 7 mm, and does not form a precisely regular cylinder.

Instead of rolling triangular bars of steel 1800 they might be rolled from steel 1200, and their quality subsequently improved by stretching and twisting as is done for Isteg steel.

II c 4

On the principles of calculation for reinforced concrete.

Zu „Berechnungsgrundlagen des Eisenbetons“.

Les principes de calcul du béton armé.

Dr. Ing. h. c. M. Roš,

Professor an der Eidg. Techn. Hochschule und Direktionspräsident der Eidg. Materialprüfungs- und Versuchsanstalt für Industrie, Bauwesen und Gewerbe, Zürich.

On the question of “ n ” — which has been so much discussed and mainly on quite erroneous grounds — it is to be remarked that within certain limits this factor has no influence if the permissible stresses are chosen in relation to the value of n selected ($n = 10, 15$ or 20). The very latest tendency to do away with the n figure altogether is to be regarded as a mistake, leading not to simplification and clarity but rather to trouble and confusion. It is possible to hold different opinions on the value of n , but as a basis for the calculation of reinforced concrete it is impossible to dispense with this figure, and for practical purposes it lies at the basis of reinforced concrete theory.

The classical theory of reinforced concrete, which relies on the *Navier-Hooke* law as regards compression, tension and bending and on the generalised *Euler* formula as regards buckling, has been extended in the last few years by knowledge won in the testing of materials — particularly as regards plastic strain — and these extensions are of great value for the more accurate estimation of the degree of safety possessed by reinforced concrete structures.

They cover the following aspects of the problem of deciding what stresses are to be regarded as permissible:

The stress-strain law of the concrete and reinforcing steel.¹

The modular ratio $n = \frac{E_e}{E_b}$ within the elastic region.²

The relationship between the prism compressive strength $p\beta_d$ and elastic modulus of the concrete bE_e .¹

The danger of breakage in concrete stressed along more than one axis. (Experiments at the Swiss Federal Institute for Testing Materials in the light of *Mohr's* theory of fracture.)³

The fatigue resistance to a pulsating load in the concrete and in the reinforcing steel,⁴ and

The laws governing stability against buckling in columns loaded centrally and eccentrically. (Experiments and theory developed at the Swiss Federal Institute for Testing Materials.)⁵, and by maintaining the closest possible

contact between the drawing office, the laboratory and the job itself it is justifiable to proceed by calculating reinforced concrete structures in accordance with the classical theory of elasticity, and at the same time to plan the organisation in such a way, and take such constructional measures as

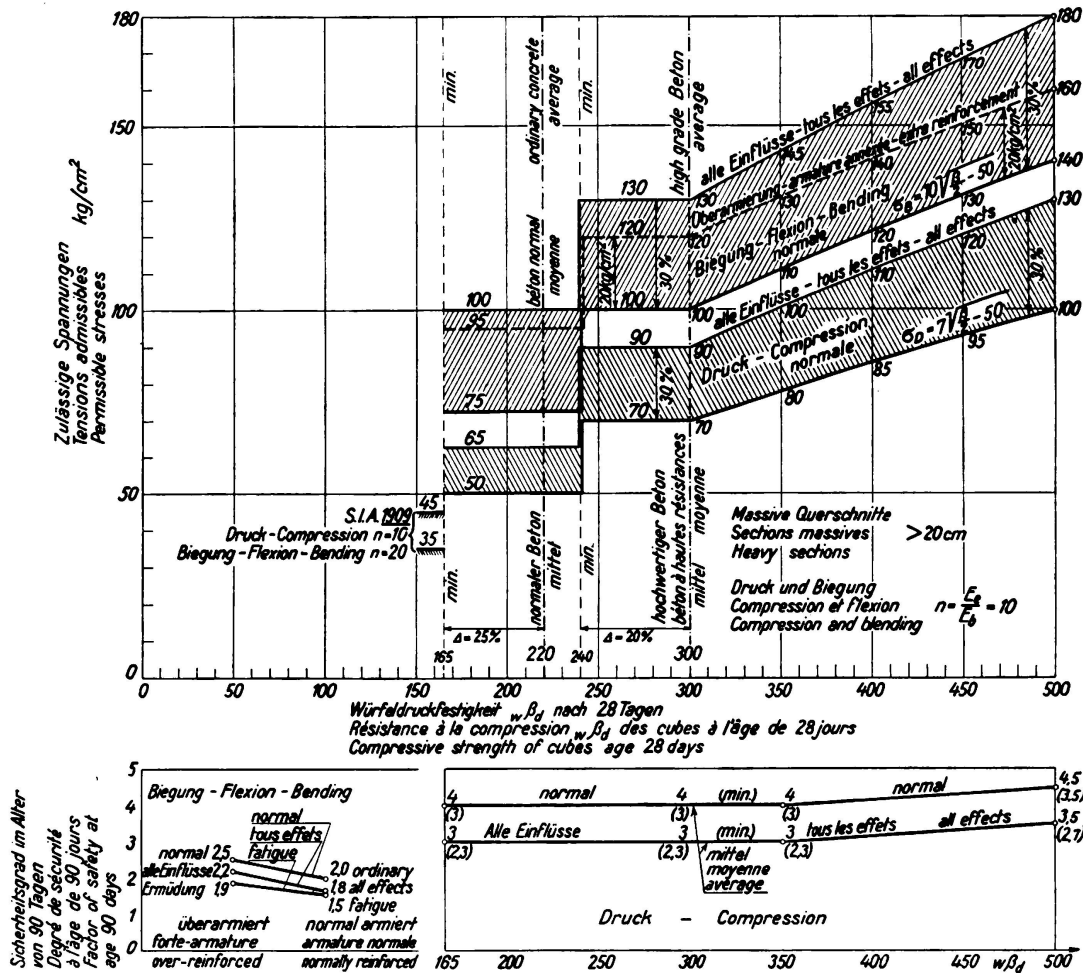

Fig. 1.

Swiss regulations for reinforced concrete of May 14th, 1935: permissible stresses in the concrete and reinforcing steel in relation to the compressive stress of the concrete and yield point of the steel.

Oblique principal stresses.

Ordinary concrete $\tau_{zul} = 4 \text{ kg/cm}^2$

High grade concrete 5 kg/cm^2

Reinforcing steel: Permissible stresses $\text{perm} \sigma_e$.

All effects:

	ordinary	high grade
Excluding temperature and shrinkage stresses	1400 kg/cm ² ,	1700 kg/cm ²
Including temperature and shrinkage stresses	1500 „	1900 „

regards both general arrangement and details, that certainty may be won as to the conditions and effects of stress, which, in its turn, will yield exact indications as to the true factor of safety.

Exhaustive experiments on completed reinforced concrete structures go to show that they behave in accordance with the elastic representation.⁶ Despite all that is being argued to the contrary, the theory of elasticity will continue in the future to serve as the basis for dimensioning and estimating the safety of reinforced concrete structures — due account being taken of the effect of plasticity of the concrete on the carrying capacity,⁷ but without encroaching on

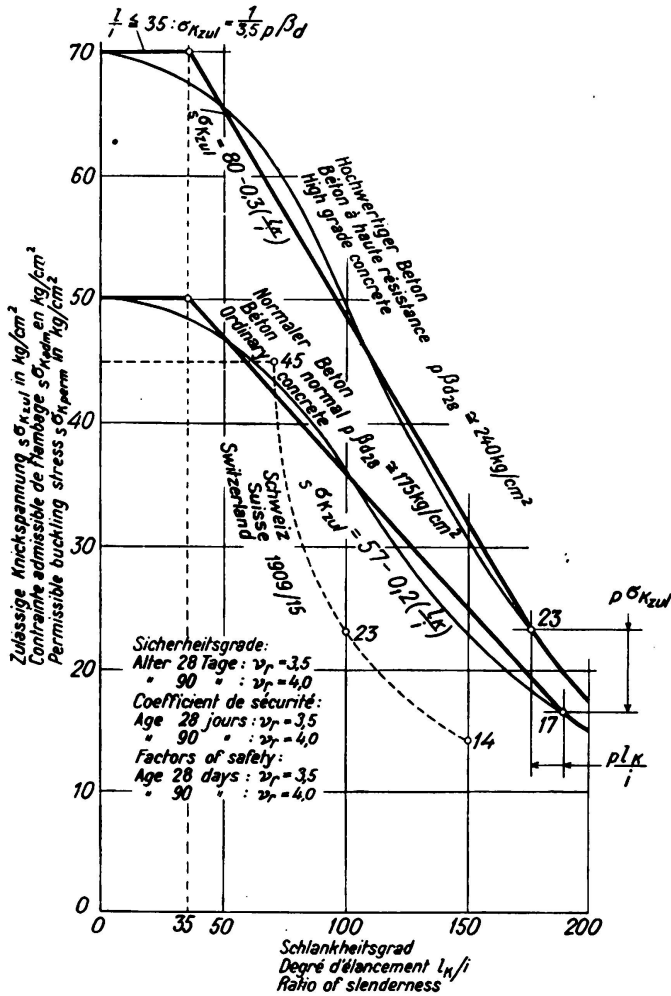

- $p\beta_d$ Prism compressive strength of concrete
- σ_q Yield point of reinforcing steel
- F_b Cross section of concrete
- F_e Cross section of steel
- μ Percentage of reinforcement $F_e:F_b$

Buckling load:

$$P_K \cong s\sigma_K F_b \left(1 + \frac{\sigma_q}{p\beta_d} \mu \right)$$

$$\text{perm } P_K = s\sigma_{Kperm} \cdot F_b (1 + n\mu)$$

Limit of proportionality:

$$\sigma_P \cong 0.33 p\beta_d$$

$$p\sigma_{Kperm} \cong \frac{1}{3.5} \cdot 0.33 p\beta_d$$

$$\frac{p l_K}{i} = \pi \sqrt{\frac{E'_{min}}{0.33 p\beta_d}}$$

$$E'_{min} \cong 0.75 \cdot 550000 \frac{p\beta_d}{p\beta_d + 150}$$

Fig. 2.

Concrete columns without hoop reinforcement, with longitudinal reinforcement $\mu \cong 1\%$.

Permissible concentric buckling stresses $s\sigma_{Kperm}$ for $m = 0$.

Ordinary and high grade concrete.

the final reserves possessed in this way by the material.⁸ It may be said that the axial and shear forces and bending moment which result from the imposition of external loads are now determined in all countries by fundamentally the same rules, so that if definite principles for estimating of the conditions of breaking, fatigue and buckling can be agreed upon on an international basis, the international regulation of calculated factors of safety will be a matter only of careful and wellfounded understandig.

The *unification of principles* would have to be based on characteristics of materials which, while not yet expressed quantitatively in all countries, are nevertheless understood in the same sense. Such characteristics, as regards reinforced concrete, include the following:

The modular ratio $n = \frac{E_e}{E_b}$.

The yield point of the reinforcing steel σ_f

The yield point σ_s under tension.

The breaking point σ_q under compression.

The fatigue resistance to a pulsating non-alternating stress in the reinforcing steel $\sigma_u \cong 0.85 \sigma_f$.

The prism compressive strength of the concrete $p\beta_d \cong 0.8 \sqrt{\beta_d}$, $w\beta_d$ = cube compressive strength.

The limit of proportionality of the concrete $0.33 p\beta_d \cong b\sigma_{zul} \cong \sigma_p = \text{Euler's buckling stress}$.

The fatigue strength of the concrete $\sigma_u \cong 0.6 p\beta_d$ = resistance to pulsating stresses without change of sign.

The buckling modulus T_K .

The percentage of reinforcement $\mu = \frac{F_e}{F_b}$.

It would appear desirable to observe a calculated factor of safety of between ~ 1.8 and ~ 2.5 as regards static failure, a factor of safety of ~ 1.5 to ~ 2.0 against fatigue, and one between ~ 3 and ~ 4 against buckling, having reference in each case to the total load. The following permissible stresses might then be adopted as a basis:

All Effects

	Excluding shrinkage and heat σ_{zul} -values	Including shrinkage and heat σ_{zul} -values
Concrete: normally reinforced	$\sim 0.4 p\beta_d$	$\sim 0.5 p\beta_d$
Concrete: over-reinforced		
$eff\sigma_c <_{zul}\sigma_e$	$\sim 0.4 p\beta_d$	$\sim 0.5 p\beta_d$
	+ 0.05 ($_{zul}\sigma_e - eff\sigma_c$)	+ 0.065 ($_{zul}\sigma_c - eff\sigma_c$)
Reinforcing steel: normal quality		
$\sigma_s \cong 2400 \text{ kg/cm}^2$	~ 0.5 to $0.6 \cdot \sigma_s$	$\sim 0.65 \sigma_s$
Reinforcing steel: high-tensile		
$\sigma_s \cong 3500 \text{ kg/cm}^2$	~ 0.45 to $0.5 \cdot \sigma_s$	$\sim 0.55 \sigma_s$

The higher values as here proposed for the permissible stresses in the concrete in over-reinforced sections (wherein the permissible stresses of the steel reinforcement is not fully utilised) are based on the results of a great many breaking tests, and are also supported by theoretical considerations such as the greater depth of the neutral axis in such cases, and the plasticity of the con-

crete. The same "n" figure is retained as in normally reinforced sections, as it is more correct to adopt this method than to increase "n".

In view of the smaller risk of breakage the permissible extreme fibre stress of the concrete under bending may be fixed 40% higher than the stress under direct compression.

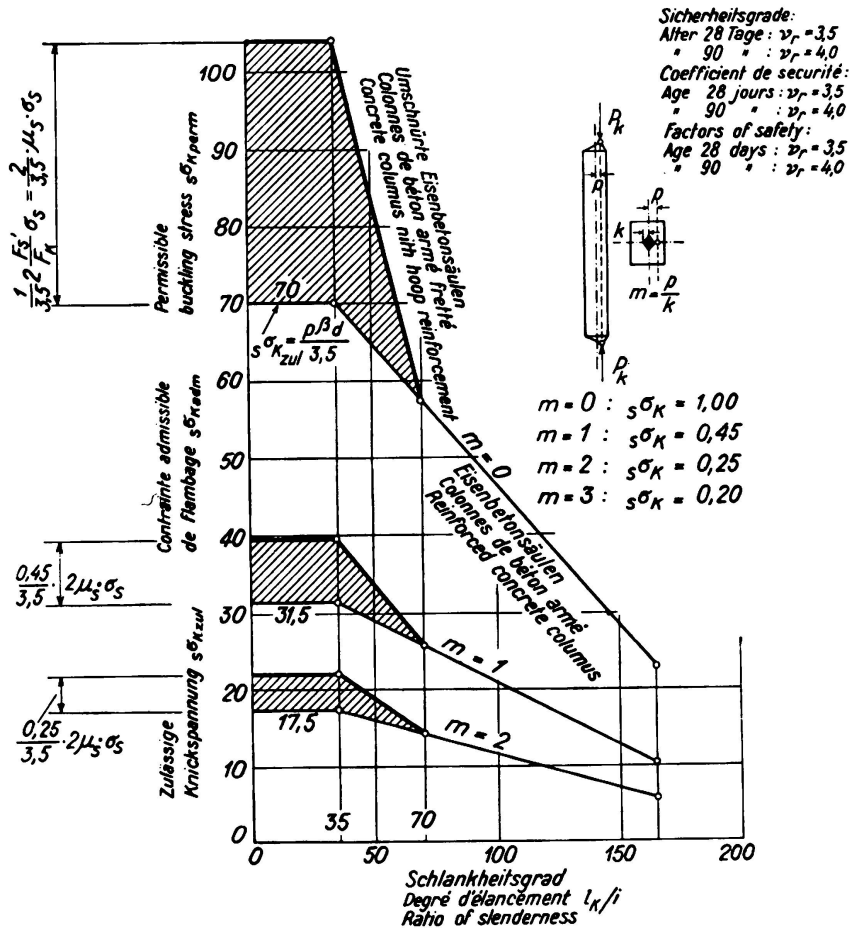

Fig. 3.

Concrete columns with hoop reinforcement and longitudinal reinforcement.

Permissible concentric buckling stresses $s\sigma_K$ perm.

For $m = 0$, $m = 1$ and $m = 2$. High grade concrete.

Concrete columns with longitudinal reinforcement:

$$\text{Buckling load: } P_K \cong s\sigma_K F_b \left(1 + \frac{\sigma_q}{p\beta_d} \cdot \mu \right); \quad \left(\frac{l_K}{i} \right) \geq 70$$

Concrete columns with longitudinal and hoop reinforcement:

$$\text{Breaking load: } P_{\text{failure}} = bF_K (p\beta_d + 2\mu_s \cdot \sigma_s) \left(1 + \frac{\sigma_q}{p\beta_d} \mu \right); \quad \left(\frac{l_K}{i} \right) \leq 35$$

$$\text{Buckling load: } P_K \cong s\sigma_K \left(bF_K + \frac{\sigma_q}{p\beta_d} F_e + 2 \frac{\sigma_s}{s\sigma_K} F'_s \frac{70 - \frac{l_K}{i}}{35} \right);$$

$$35 \leq \left(\frac{l_K}{i} \right) \leq 70.$$

The effect of the principles explained in the preceding paragraph on the new Swiss regulations for reinforced concrete, dated 14th of May 1935, is represented in Fig. 1, showing graphically:

The permissible stresses in the concrete σ_b under compression and bending,⁹ in relation to the quality of the concrete (cube strength), and the factor of safety referred to an age of 90 days.

The permissible stresses in resistance to buckling, for columns with and without hoop reinforcement in normal and high grade concrete, may be taken from Figs. 2 and 3. The contents of Figs. 1, 2 and 3 may serve as an indication of the great advances made in reinforced concrete construction in the last few years, and of the new possibilities of design.

The knowledge now available, based on theoretical and technical conceptions drawn from the field of testing materials — such as strength and deformation — and also on experience gained in practice,¹⁰ offers a starting point for international cooperation to aim at *unification of the interpretation of the laws governing the strength of materials* and at *the establishment of definite factors of safety in reinforced concrete construction*.

Bibliography.

¹ M. Roš: „Die Druckelastizität des Mörtels und des Betons.“ Report No. 8 of Swiss Federal Institute for Testing Materials, Zürich, 1925.

² M. Roš: «Coefficient d'équivalence $n = \frac{E_{acier}}{E_{béton}}$ et tensions admissible du béton et de l'acier.» First International Congress on Concrete and Reinforced Concrete, Liège, 1930.

³ M. Roš and A. Eichinger: „Versuche zur Klärung der Frage der Bruchgefahr — II. Nicht-metallische Stoffe.“ Report No. 28 of Swiss Federal Institute for Testing Materials, Zürich, 1928.

⁴ S. A. Mortada: „Beitrag zur Untersuchung der Fachwerke aus geschweißtem Stahl und Eisenbeton unter statischen und Dauerbeanspruchungen.“ Report No. 103 of the Swiss Federal Institute for Testing Materials, Zürich, 1936.

⁵ M. Roš: «La stabilité des barres comprimées par des forces excentrées.» I.A.B.S.E. Congress Paris, 1932, Preliminary Report. — O. Baumann: „Die Knickung der Eisenbetonsäulen.“ Report No. 89 of the Swiss Federal Institute for Testing Materials, Zürich, 1934.

⁶ F. Campus: «Influence des propriétés physiques des matériaux sur la statique du béton armé.» I.A.B.S.E. Congress, Final Report, Paris 1932.

⁷ M. Roš: «La stabilité des barres comprimées par des forces excentrées.» I.A.B.S.E. Congress, Paris 1932, Preliminary Report. — O. Baumann: „Die Knickung der Eisenbetonsäulen.“ Report No. 89 of the Swiss Federal Institute for Testing Materials, Zürich 1934.

⁸ M. Roš: „Aktuelle Probleme der Materialprüfung.“ Technische Rundschau, Berne 1932.

⁹ The permissible oblique concrete stresses should not exceed one-twelfth to one-fourteenth of the permissible compressive stresses and the whole of any excess is to be taken up by inclined reinforcing bars.

¹⁰ M. Roš: „Erfahrungen mit ausgeführten Eisenbeton-Bauwerken in der Schweiz und deren Lehren für die Portlandzementindustrie.“ Separate reprint from the 24th Annual Report, 1934, of the Swiss Association of Manufacturers of Cement, Lime and Gypsum.

¹¹ M. Roš: „Vereinheitlichung der material-technischen Erkenntnisse und des Sicherheitsgrades im Stahlbetonbau.“ Monatsnachrichten des Österreichischen Betonvereins. Vol. IV, Vienna 1937.

IIc 5

Tests with Concrete Beams Reinforced with Isteg Steel. Versuche mit Eisenbetonbalken mit Isteg-Stahl- Bewehrung.

Essais de poutres en béton armé d'acier Isteg.

Dr. Ing. St. Bryła and Dr. Ing. M. T. Huber,
Professoren an der Technischen Hochschule Warschau.

An account will be given below of the results of experiments on special reinforcing bars carried out in Poland. It is known that the yield point of such bars can be considerably increased by mechanical treatment (pre-stretching) and that in this way the tensile breaking stress may be raised; the most advantageous amount of pre-stretching appears, from experience, to be approximately 6 %. In reinforced concrete members subject to bending the yield point of steel — or, the stress corresponding to an elongation of $\epsilon = 0.4\%$ — is a matter of primary importance, the failure of such members being almost always the result of the carrying capacity of the reinforcement being destroyed when ϵ reaches 0,4%. Two kinds of reinforcement which have received preliminary treatment in this way are in practical use; namely Isteg steel and expanded metal.

a) Isteg steel.

Isteg steel is manufactured by twisting together two round bars of equal diameters. In 1934 experiments on the reinforced concrete members indicated in Table I were carried out in the testing laboratory of the Technical University of Warsaw, and these disclosed some valuable properties of Isteg steel for the reinforcement of beams and slabs.

The elements marked A were reinforced with Isteg and those marked B with ordinary round bars, the reinforcement being so designed that the cross section of the Isteg steel was 33% smaller than that of the round bars in the corresponding members. The tests carried out on these materials gave the following average values:

Table 2.

Material	Yield point	Breaking stress	Modulus of elasticity
A. Isteg steel 5.5 mm	3738 kg/cm ²	4261 kg/cm ²	1 630 000
Isteg steel 7 mm	3723 "	4339 "	1 600 000
B. Round bars	2640 "	3630 "	2 101 000

It will be seen from these figures that the Isteg steel has a yield point averaging 41.3 % higher and that its strength is 18.5 % higher. The results obtained in the experiments with reinforced concrete elements led to the following conclusions.

1) *Bending strength.*

The breaking loads for elements reinforced with Isteg steel of 33 % smaller cross section were almost the same as those for members reinforced with larger section of round bars. If the amount of reinforcement was small, the first crack appeared earlier in the beams reinforced with Isteg than in those reinforced with round bars, but this difference disappeared when the amount of reinforcement was increased. With the round bars the first hair cracks spread almost immediately after their appearance into wide open fissures.

With the Isteg steel the cracks were at first almost imperceptible. They opened very slowly, even when the load was considerably increased, and did not lose the character of hair cracks. The reason for this is probably to be found in the better bond of the concrete on to the spirally wound steel rods.

The further conclusion may be drawn that the compressive stress conditions in the concrete at the instant of breakage are more favourable where Isteg reinforcement is adopted, as the deformation of the concrete takes place more uniformly, whereas with round bars this change of shape is strongly concentrated in a few short sections.

2) *Deflections.*

The deflections of the concrete elements containing Isteg steel were much greater than those of the corresponding elements containing round bars. This is easily understood on the following grounds:

- a) The stresses in the Isteg steel are some 50 % higher under the same loading than those in the round bars of the control elements, and assuming a modulus of elasticity of the same value in both cases this would imply 50 % greater elongation of the Isteg bars.
- b) Apart from this, the modulus of elasticity of the Isteg bars is lower, being $E = 1615000$, and this leads to a further increase in the elongations of approximately 30 %.

For these two reasons combined, the elongation of the Isteg steel is multiplied by $1.5 \times 1.3 = 1.95$, that is, it is increased by 95 %, and the greater deflections obtained are the result. Generally speaking, however, no disadvantage is to be apprehended from this as all reinforced concrete structures are in fact very stiff.

3) *Actual stresses.*

In the experiments carried out with elements IV and IVa the deformations ϵ in the steel and concrete respectively were measured by means of *Huggenberger* tensometers and the stresses were then calculated from the equation $\sigma = E \cdot \epsilon$ by inserting the mean values of E already determined. These stresses may be regarded as directly measured, and therefore as actual stresses.

Table 1.

Summary of

Nr.	Dimensionen — Dimensions	Beton Nr. Béton No. Concrete Nr.	Ausgeführt Executé Executed	Geprüft Essayé Tested	Zweck der Probe But de l'essai Purpose of testing
II-A		2	27/IX	22/IX	Haftung — Grip
II-B		2	27/IX	22/IX	Haftung — Grip
III-A		2	27/IX	24/IX	Druck — Compression
III-B		2	27/IX	24/IX	Druck — Compression
IIIa-A		2	27/IX	24/IX	Druck — Compression
IIIa-B		2	27/IX	24/IX	Druck — Compression

Table 1.

specimens tested.

Nr.	Dimensionen — Dimensions	Beton Nr. Béton No. Concrete Nr.	Ausgeführt Exécuté Executed	Geprüft Essaysé Tested	Zweck der Probe But de l'essai Purpose of testing
IV-A		2	27/IX.	21/XI.	Druck — Compression
IV-B		2	27/IX.	21/XI.	
IVa-A		2	27/IX.	21/XI.	
IVa-B		2	27/IX.	21/XI.	
I-A		1	18/IX.	18/X.	Durchbiegung — Fläcbe — Deflection
I-B		1	18/IX.	18/X.	

Table 3. Comparison between calculated and measured stresses.

Beam	Reinforce- ment	Concrete (measured)		Steel (measured)		Concrete: calculated for			Steel: calculated for		
		total ϵ	elastic ϵ	total ϵ	elastic ϵ	Phase I	Phase II with		Phase I	Phase II	
							n=15	true n		n=15	true n
IV B	Round bars	30.1	26.8	903	420	21.4	31.9	37.9	105	785	772
IV A	Isteg	49.2	35.2	536	363	24.6	34.9	45.3	120	772	748
IV a B	Round bars	24.3	21.8	307	202	19.3	22.1	24.9	82	258	249
IV a A	Isteg	29.7	23.6	377	194	19.7	24.5	30.8	90	380	360

In Table 3 two sets of values of the "measured" stresses are compared, namely those calculated from the total elongations and those calculated from the elastic elongations within the range of load of 500 kg. Corresponding stresses are calculated for Phase I with $n = 8$ and for Phase II with $n = 15$. Also with

$$\text{true } n = \frac{\text{true value of E for steel}}{\text{true value of E for concrete}}$$

It must be stated that although the measurements were actually made in Phase I the measured stresses correspond more closely with those calculated for Phase II. In the concrete the agreement between the measured and the calculated stresses is fairly good with $n = 15$, especially if account is taken only of the elastic elongations. Reasonably good agreement between the measured and the calculated stresses for the total deformation is also obtained, especially if the true value of n is used.

As regards the reinforcement, however, only those stresses which are calculated from the total elongation approximate to the calculated stresses in Phase II, the measured stresses for the round reinforcing bars being a little higher and those for the Isteg bars a little lower. Stresses calculated on the basis of elastic deformation alone worked out lower, without any exception, by about 50% in comparison with the calculated stresses for Phase II, but from two to four times higher than the calculated stresses according to Phase I. The true stresses therefore lie between those found from Phase I and Phase II. This can only be explained on the assumption that n is considerably greater for the tensile zone in Phase I than the usually assumed value $n = 8$.

It may be assumed as probable that the measured stresses in the reinforcement agree with the unknown actual stresses, but as regards the stresses in the concrete matters are different for the following reasons:

1) Within the scope of the measurements the reinforced concrete sections are working according to Phase I, so that the statical behaviour is not like that which would correspond to Phase II.

2) The actual distribution of stresses is very different from the *Navier* distribution, and — especially in the case of the round bars — the stresses around the bars are smaller and the stresses close to the neutral axis greater than is implied by the linear diagram. It may be concluded from this that the actual stresses are lower than is implied by calculation from the measurements as above. The mean value of E in bending must be smaller than in pure com-

pression. Several foreign experimenters have given the following values for concrete:

$$E_{\text{for bending}} = \frac{2}{3} \text{ to } \frac{1}{2} E_{\text{for axial compression}}$$

The close agreement of the measured stresses with the calculated stresses (according to the usual formula for Phase II) is, therefore, relevant to the present case.

4) *The coefficient n.*

The results of the present experiments do not entail the adoption of another value of n than that which is now usual in calculations where Isteg steel is adopted, although direct measurement of the elastic characteristics of Isteg steel by comparison with concrete gives an average value of $n = 9$. In practice, however, the calculated stresses are almost independent of n . Moreover, according to a number of experiments which have been carried out, the true value of n varies a great deal and depends upon the stresses, even assuming the same kind of concrete.

5) *Gripping stresses.*

The Isteg steel with 33% smaller cross section gave more than 20% higher grip resistance than the ordinary round bars, and if the load was further increased the Isteg steel was found to slip more slowly than was the case with round bars.

6) *Shear.*

There can be no doubt that in the experiments carried out on beams III and IIIa the governing factor was not the compressive strength of the concrete but the shear forces. Under bending loads the weakest part of each beam was the cross section immediately below the concentrated load, because at this point most of the reinforcing bars provided for the purpose of resisting the bending moment were bent up at a place where the magnitude of this moment was still at a maximum.

The compressive stresses in the concrete were calculated for Phase I and Phase II. The stresses in the reinforcing bars were calculated both for the bent up bars and in reference to all the bars.

Table 4 shows the stress values in kg/cm^2 when the first crack appeared, and it will be seen that this happened at practically the same time with either methods of reinforcement.

Table 4. Shear stresses.

Beam	Reinforcement	Stress in Concrete		Stresses in reinforcement	
		Phase I	Phase II	Bent-up bars	all bars
III B	Round bars	21.0	30.8	4780	1970
III a B	"	18.7	37.6	2930	1604
III A	Isteg steel	21.2	29.7	7260	3010
III a A	"	18.1	34.9	4675	2450

It is a matter of great difficulty to estimate the stresses in the bent-up bars. The usual method of calculation, which assumes that in the absence of stirrups the whole of the shear force is carried by the bent-up bars, is:

$$\text{Stress in bent-up bars} = \frac{\text{Total shear}}{\text{Area of bent-up bars} \times \sqrt{2}}$$

but this led to quite impossible values in the present case, greatly exceeding the breaking stress of the material. This explains the effective cooperation of the straight bars on account of the good anchorage provided outside the supports.

When, however, the stresses in the reinforcement are calculated in reference to the straight bars by the formula:

$$\text{Stress in bars} = \frac{\text{Total shear}}{\text{Area of straight bars} + \text{Area of bent-up bars} \times \sqrt{2}}$$

values are obtained which correspond almost exactly with the bending stresses. It follows from the comparison of the breaking load stresses calculated in relation to the whole of the bars that in this case, also, the carrying capacity of the Isteg steel is 1.5 times as great as that obtained with ordinary reinforcement.

b) Expanded metal.

Expanded metal, as is well known, consists of a network of rhomboidal spaces which is produced by special machines from annealed steel sheets. The smaller angle of each rhomboid is about 41° , this optimum value having been determined by experiments. The side strips of such a rhomboid undergo an elongation amounting to

$$\frac{1}{\cos 20.5^\circ} - 1 = 0.067 = 7\%$$

This value practically agrees with the elongation of the material used for Isteg steel, which is about 6%.

Expanded metal is manufactured from sheet thicknesses of 0.5 to 4.5 mm. The width of the strips varies from 2.5 to 10 mm and the sizes of the rhomboid are 10/42, 20/62, 40/115, 75/200 and 150/400 mm respectively. Expanded metal has already been in use for some forty years and has frequently been examined in testing stations.

Table 5. Tests on Expanded Metal.

Plate			Expanded metal			% change through working		
σ_p kg/cm ²	σ_s kg/cm ²	ϵ %	σ_p kg/cm ²	σ_s kg/cm ²	ϵ %	σ_p kg/cm ²	σ_s kg/cm ²	ϵ %
2848	3375	22.1	3736	3993	11	+ 30.1	+ 18.1	— 50.3
3042	4205	26.2	4544	4715	10.9	+ 49.2	+ 12.2	— 58.4
3129	4204	23.9	4728	5001	12.1	+ 51.1	+ 18.8	— 49.4
3234	3787	23	4607	4667	7.7	+ 42.4	+ 23.3	— 66.5

In the autumn of 1934 experiments were carried out in the testing laboratory of the Technical University of Warsaw to determine the increase in the yield point which results from the permanent elongation of the sheet metal strips in the production of expanded metal, and the results of these experiments are given in Table 5 above.

It was found, in agreement with foreign experiments, that the yield point of the expanded metal may be in excess of 3600 kg/cm^2 and that the best results are obtained with soft sheets having a maximum amount of extensibility ϵ . Reinforced concrete elements containing expanded metal have been in practical use for years. The cooperation between the expanded metal and the concrete is very similar to that of Isteg steel. The deflections obtained are greater than with round bar reinforcement A 35, but the cracks are smaller, more numerous and more uniform, with the result that the stress on the concrete in compression is more uniform. The greater resistance to slip possessed by Isteg steel is easily explained by its special shape, each of the many intersections acting as a separate hook. Expanded metal by itself would be subject to a great deal of deformation. Embedment in the concrete has the effect of considerably stiffening the intersections of the network, and thus hinders deformation of the spaces enclosed. In order to render this stiffening effective the sizes of the openings should not be too small. The conclusions obtained in regard to Isteg are fundamentally valid also for expanded metal.

IIc 6

Experiments on Tubular Beams of Centrifugally Cast Concrete.

Versuche mit Schleuderbeton-Rohrbalkenträgern.

Essais effectués sur des poutres tubulaires en béton centrifugé.

Dr. Ing. A. Král,

Professor der techn. Fakultät an der Universität Ljubljana.

In the summer of 1936 a large job was completed in the Yugoslavian textile mills at Duga Resa near Karlovac (Banat of Save), in which roof girders took the form of pipe beams made of centrifugal concrete. The arrangement of the roof construction may be seen in Fig. 1. The opportunity was seized to make several series of exhaustive experiments at the materials testing station of the University of Ljubljana on differently designed and differently reinforced pipe beams.

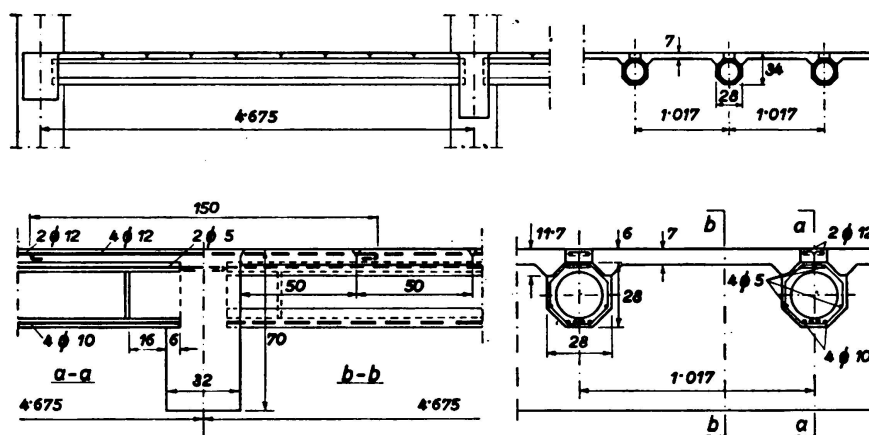

Fig. 1.

The pipes were made in three different shapes, namely:

- 1) an octagonal form as in Fig. 2a with a constructional depth of 28 cm;
- 2) the same form with a constructional depth of 22 cm; and
- 3) a polygonal form widened in the tension zone as shown in Fig. 2b.

Individual pipes, intended for heavy isolated loads, were provided with transverse stiffeners at the load points and at the supports, in order to prevent premature damage through the pipe collapsing.

As shown in Fig. 2 the reinforcement consists of four bars of 5 mm diameter in the upper and middle corners and tensile reinforcement in the lower side, in addition to spiral hooping of steel wire 3 mm in diameter fixed by the con-

tractor which (with the exception of pipe 17 and pipe 18) was welded to the compression and tensile reinforcements at particular points.

The following materials were used for the reinforcements:

- 1) Structural steel C 37 obtained from the Kranjska Industrijska Družba at Jesenice (corresponding to the German steel St. 37).
- 2) Isteg steel, supplied by the same firm.

The pitch of the spiral hooping was made variable, and in places two spirals were used.

High grade Portland cement of the "Stockbrand" mark, supplied by the Portland cement factory at Split, was used for all the pipes. The aggregate consisted partly of limestone of 13 mm gauge, obtained from the quarries of the

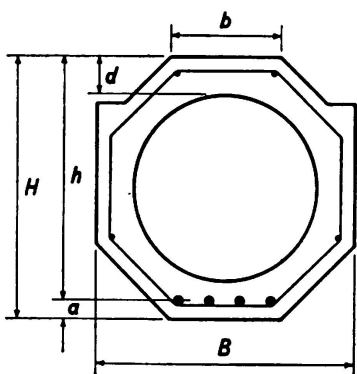

Fig. 2 a.

Beams Nos. 1 to 12, 17 to 22, I to III.

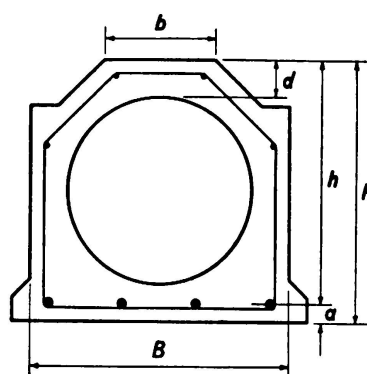

Fig. 2 b.

Beams Nos. 13 to 16.

textile works at Duga Resa, and partly gravel and sand taken from the Save-river, up to 13 mm in gauge.

The following three mixes were used:

- 1) Broken limestone with 410 kg of cement per cubic metre of finished concrete, water cement ratio 0.45—0.515.
- 2) Save gravel and sand with 410 kg of cement per cubic metre of finished concrete, water cement ratio 0.45—0.50.
- 3) Broken limestone with 300 kg of cement to one cubic metre of finished concrete, water cement ratio 0.69—0.72.

The reinforcing steel C 37 showed mechanical properties considerably better than the minima laid down in the standard. Its yield point varied on an average between 29.52 and 33.07 kg/mm²; the tensile strength between 40.41 and 42.43 kg/mm²; the specific elongation at fracture, in a gauge length of ten diameters, between 27.3 and 40.7 %.

The Isteg steel had an ultimate strength of 44.7 to 47.4 kg/mm², an elastic limit of 37.9 to 40.3 kg/mm² for 4 % elongation, and an elongation of breakage of 5.5 to 8.5 %.

The average strength of the different kinds of concrete at an age of four weeks may be seen from the following table:

Nature of aggregate	Cement kg per m ³ of concrete	Cube strength per kg/cm ²	Tensile bending strength per kg/cm ²
Broken limestone . . .	410	630	62.3
Save gravel and sand . .	410	585	56.9
Broken limestone . . .	300	639	54.4

The test specimens were prepared not in the laboratory but on the job, and the dates of production are those given by the supervisors of the work. In the laboratory exact dimensions and weights were recorded, and in the case of the pipe beams which were tested to destruction the reinforcement was afterwards exposed and remeasured.

The investigation extended to 21 series of variously designed types of beam, each represented by two samples, so that altogether it covered 42 pipe beams, from which only a few characteristics results will be given below.

Fig. 3 shows the relationship between the breaking moment and the amount of tensile reinforcement, using the normal round steel C 37 and the Isteg steel, for two different types of beam of 28 and 22 cm depths respectively.

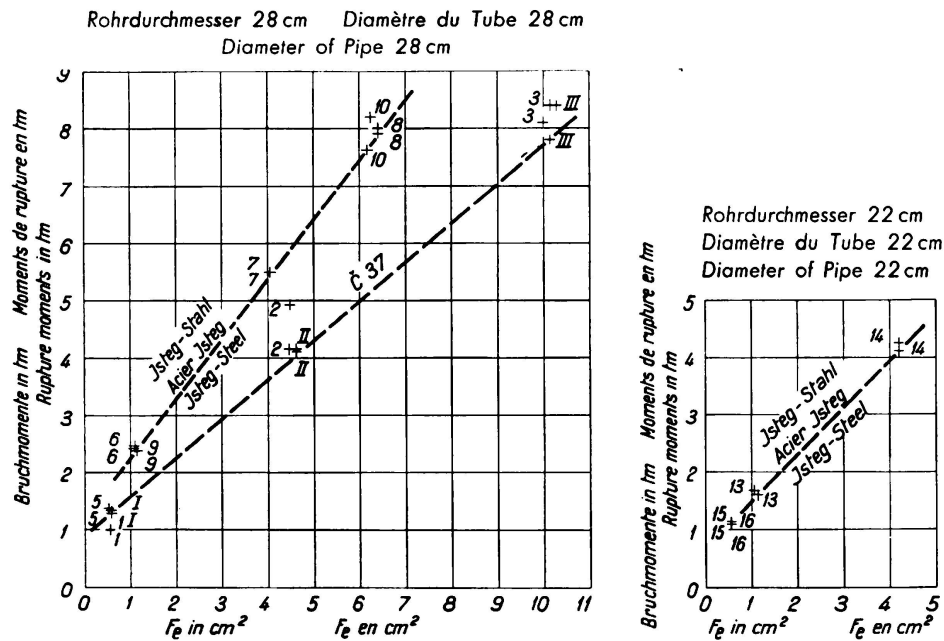

Fig. 3.

In this summary the great uniformity (or small amount of scattering) of the experimental results is apparent, and this is true not only as regards individual pairs of beams but also as regards the uniform increase in breaking moment according to the reinforcement provided.

In order to show details of the experiments, and the kind of results obtained, the following is a table of the results for six characteristic beams

with weak, medium and strong tensile reinforcement respectively, both with round steel C 37 and with Isteg steel.

No.	Reinforcement			Bending moment		Calculated steel stress at fracture
	Type of steel	ϕ	Area	at cracking	at fracture	
		mm	cm ²	tonne-metres	tonne-metres	kg/cm ²
5	C 37	2 ϕ 6	0.58	0.78	1.29	9460
2	„	4 ϕ 12	4.48	1.79	4.16	4205
3	„	4 ϕ 18	9.99	3.32	8.10	3883
6	Isteg	2 \odot 6	1.08	0.82	2.43	9490
7	„	4 \odot 8	4.07	1.79	5.49	5885
8	„	5 \odot 10	6.41	2.66	7.91	5575

The summary shows that in the case of the lightly reinforced beams no cracking appeared under a load equal to half the working load, and the same result was obtained in the other series of experiments. In beams containing heavier reinforcement, or in those with Isteg reinforcement, fine cracks made their appearance earlier; but under a load equal to half the breaking load the distribution of these fine cracks was in one series within the region of the maximum bending stresses, and when the load was removed they closed up again so as to be scarcely perceptible with the naked eye. Open cracks did not appear until fracture.

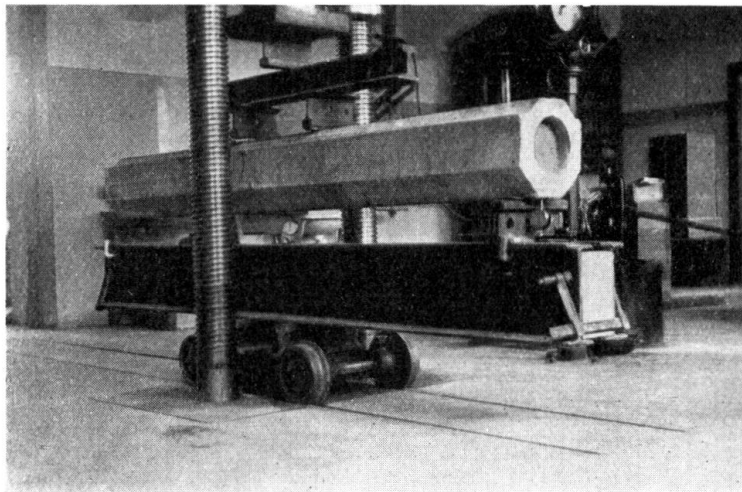

Fig. 4.
Arrangement of experiments.

In the case of the lightly reinforced pipes only tensile cracks were visible, even in the breaking condition. With the heavier tensile reinforcement and single spiral hooping shear cracks arose which in some cases spread into pipe-bursting-cracks or combined with the latter. With the heavier hooping a bulging of the concrete occurred in the compression zone, usually in the neighbourhood of the load point. With lighter hooping, failure occurred by bursting of the pipes, especially in the case of the pair of pipes marked "1" (Fig. 3).

The steel stresses given in the table, which were calculated on the assumption of a modular ratio of 10 as for Condition II, indicate that — especially in the case of lightly reinforced beams — the theoretical steel stresses assume illusory values. This is attributable to the fact that in these beams (even when in the breaking condition) the concrete in the tension zone continues to co-operate very considerably in spite of its continuity being impaired by cracks. The heavier the reinforcement the more closely did the calculated stress in the steel just before fracture approximate to the yield point of the reinforcement.

Measurements of bending under repeated loading show excellent elastic performance in addition to the normal phenomena of plasticity; hence the classical

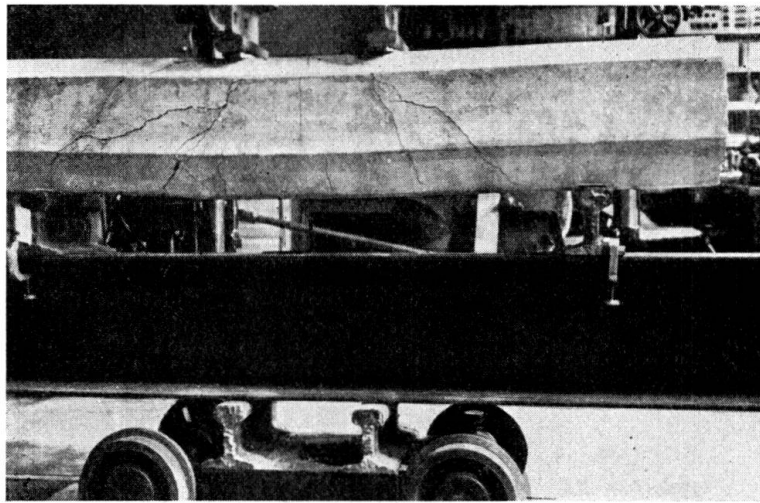

Fig. 5.

Cracks resulting from combined shear and crushing of tube.

theory of elasticity may be used for determining the stresses and strains in beams of this kind. As in all reinforced concrete work it is mainly a question of the correct assumption of elastic constants. As regards bending stresses some amplification or correction of the classical *Bernoulli-Navier* theory of bending would appear, if possible, to be desirable, but in any case there are no insuperable difficulties in determining the stresses at the most dangerous points by reference to the elasticity theory with sufficient approximation, and where pipe beams are to be built up as here into a three-dimensional system this is especially important. The fact that the results of calculations made by assuming a linear condition of stress should differ greatly from the true conditions determined by a three-dimensional elasticity-tensor field is no more than logical, and is illustrated in the results given above.

The great uniformity of the test results is doubtless attributable to the concrete being exceptionally dense and regular, as could be observed at the fractures. These properties, which have been found in a considerable number of beams produced under factory conditions, go to show that the centrifugal process — already long in use for making transmission poles and pressure pipes — may rationally be applied to the production of load bearing beams also, provided that careful workmanship can be counted upon.

IIc 7

The Safety of Reinforced Concrete Structures.

Zur Frage der Sicherheit im Eisenbetonbau.

La sécurité des constructions en béton armé.

Ing. A. Umlauf,

Wien.

If a review is made of the increasing use of high tensile structural steels in reinforced concrete structures, numerous reports on experiments with such steels will be found in the literature dating from soon after the War.

It is proper that attention should be directed first to the problem which is of most frequent occurrence and admits of easiest experiment: namely that of bending. In this connection, the most important and interesting of the experiments made to date are those to establish a comparison with St. 37, the type of steel hitherto customary for reinforcement. One of the best of the few summaries of such experiments that have appeared is that by *Dr. Emperger*, which led to the discovery that when various specimens containing samples of steels with abnormally high yield points were tested, much greater breaking strengths were obtained than was to be expected from the usual calculations for bending. It was found that the coefficient of $n = 15$ usually adopted in the bending calculations was too high for the ordinary steel St. 37. (In Switzerland and Yugoslavia $n = 10$ is employed.)

A certain variability in the coefficient n had already been recognised in Great Britain by making its value depend on the cube strength. In Austria a correction of the concrete stress, where high tensile steel is used, has been permitted since 1928 for a special cold stretched steel with a yield point of 3600 kg/cm^2 and similarly in Bulgaria an increase in the concrete stress of 15% has been sanctioned. Very recently a New York regulation has authorised an increase in the concrete stress of 15% in reinforced concrete beams containing high tensile steel.

In Germany, also, the knowledge now available has not been neglected, and since 1932 the Ministry of Public Welfare has allowed the concrete stress to be increased by 15% where the special steel mentioned above is employed. The Ministry of Finance in Berlin, in view of various problems which are still outstanding in this connection, has accepted the proposal put forward by the German Committee for Reinforced Concrete that special regulations should be considered, and these are expected to be ready in the spring of 1937 after the conclusion of the relative experiments now in hand by that Committee. When the results of these experiments are available, the authorities concerned will, no doubt, amend the relevant regulations in accordance with them as has been done in the latest

Austrian standard or "Oenorm". In the latter, the increase in breaking loads established by *Dr. Emperger's* survey in comparison with the loads calculated on the basis of $n = 15$ has been accepted as justifying the use of higher steel stresses in the calculations (and also higher concrete stresses) than where ordinary steels are used, and these increases vary from 15% for ordinary steels to 25% or more for high tensile steels.

From this point of view the proposal made by *Dr. Friedrich* of Dresden before the present Congress is no doubt a welcome advance, involving, as it does, the substitution of a rectangular distribution of the compressive stress due to bending for the impracticable triangular distribution assumed at present. The proposal carries all the more weight because other workers — such as, for

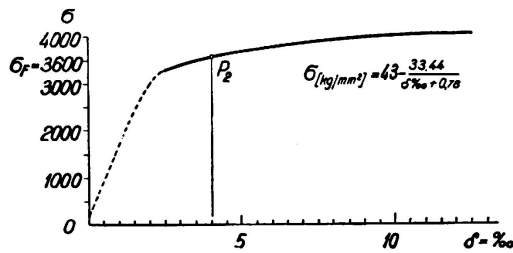

Fig. 1.
Isteg-Steel

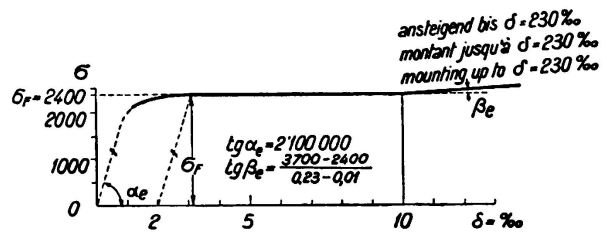

Fig. 2.
Steel St. 37.

instance, Hofrat *Saliger* of Vienna, Professor *Brandtzaeg* of Trontheim and *Dr. Bittner* of Vienna — have also arrived at this form of distribution of stress. By such a method the calculation is rendered very easy, but in view of the many experimental results obtained in Germany, Austria, Switzerland, Czecho-Slovakia, U.S.A. and other countries, it would still appear expedient to make use of $n = 10$ for ordinary steels and $n = 15$ for high tensile steels in calculating the neutral axis assuming that the yield point of the steels is not less than 3600 kg/cm².

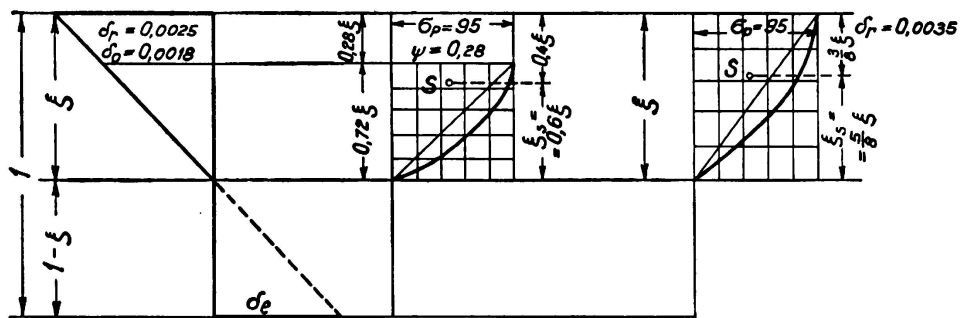

Fig. 3 a.

Fig. 3 b.

Fig. 3 c.

In order to give the proposal a more definite form, advantage might be taken of the regularity of the stress-strain curve for structural steels under tensile stress by adopting the suggestion made by *Klockner* of Prague that the relationship in question is best represented as a hyperbola connecting to the straight line of *Hooke's* Law (Fig. 1). The resulting curve for ordinary steel is shown in Fig. 2, and the elongations when the cross section is assumed to remain constant in Fig. 3. Fig. 3b shows the stress-strain curves plotted as parabolae

and indicating an increase in compressive strain towards the edge of the beam but without any corresponding increase in stress in the final portion. Fig. 3c shows a similar parabolic shape of the stress-strain curve for concrete.

Adopting the hyperbolic form of equation for the shape of the stress-strain curve of the steel, and the parabolic form for that of the concrete (or a parabola combined with a rectangle), it becomes possible, on purely theoretical grounds, to calculate the curve of $\frac{M}{bh^2}$ in relation to the percentage of reinforcement.

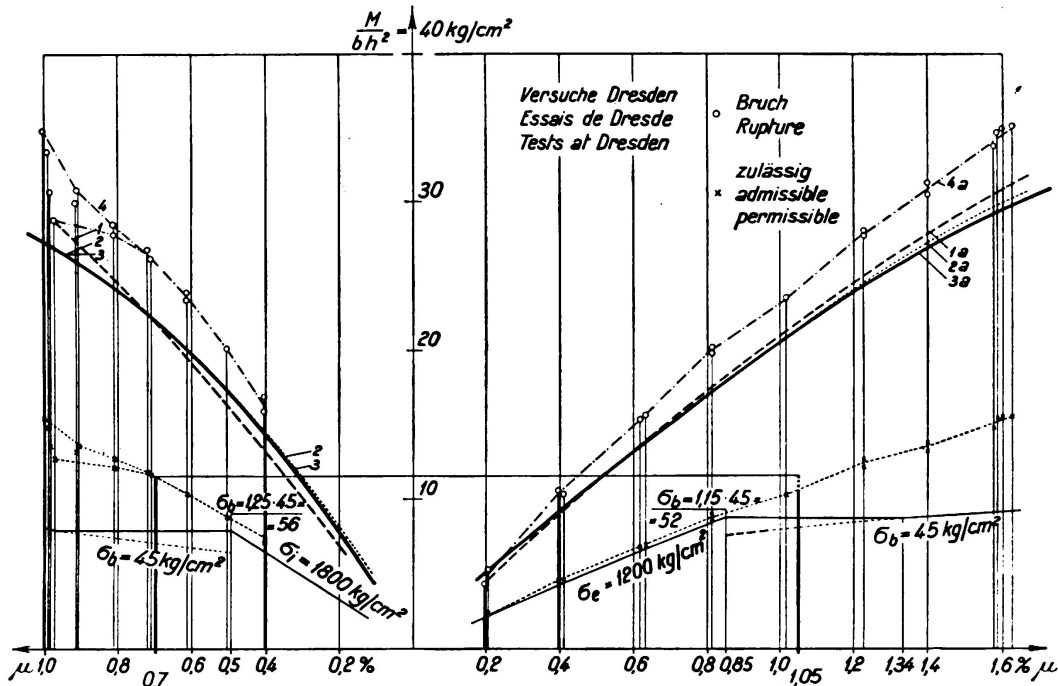

Fig. 4.

Isteg.

St. 37.

Fig. 4 shows curves of resisting moments calculated by Professor Roš in accordance with the Swiss regulations mentioned above, using either of the above assumptions — on the left for Isteg steel which is chosen as an example of the high tensile steels, and on the right for St. 37, these being represented by the lines marked 1, 2 and 3 and 1a, 2a und 3a respectively, which it will be seen practically coincide. Lines 4 and 4a contain points representing a series of comparative experiments carried out at Dresden in which concrete of the lowest possible cube strength of 110 kg/cm² was purposely used, and in which the minimum cube strength required by the regulations, 160 kg/cm² was reduced by two-thirds, corresponding to twice the *degree of safety* in the steel and to three times that in the concrete. It is concluded that by halving the ordinates of the curve of resisting moment, values are obtained which represent the minima to be allowed.

The curves in bold lines show the effect of a correction of 25% in the concrete stress where high tensile steel is used in accordance with the Austrian standards.

Fig. 5 indicates that assuming, for instance, a 15% increase on account of high tensile steel, the degree of safety thus obtained is in no way less favourable

than with round bars under the ordinary regulations. It is clear, however, that the degree of safety calculated in accordance with the regulations varies a great deal according to the percentage of reinforcement provided. This goes to show

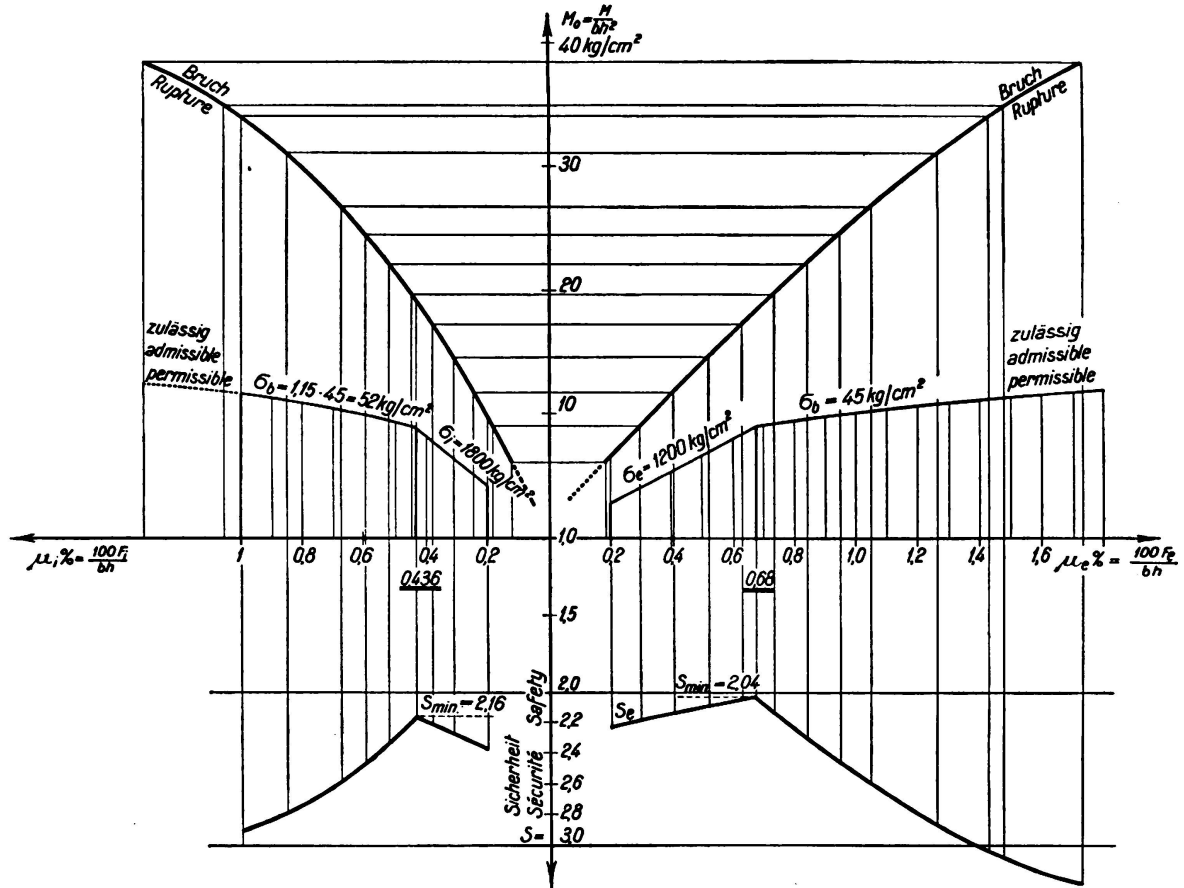

Fig. 5.

Isteg.

St. 37.

how very important it is that methods of calculation should be adapted in such a way as to ensure the possibilities of high tensile steel being utilised to their full economic advantage, when designing members to resist bending, and at the same time to obtain closer agreement with the latest experimental knowledge than is possible with the present methods.