

IIIb. Design and execution of welds with special consideration of thermal stresses

Objektyp: **Group**

Zeitschrift: **IABSE congress report = Rapport du congrès AIPC = IVBH
Kongressbericht**

Band (Jahr): **2 (1936)**

PDF erstellt am: **21.07.2024**

Nutzungsbedingungen

Die ETH-Bibliothek ist Anbieterin der digitalisierten Zeitschriften. Sie besitzt keine Urheberrechte an den Inhalten der Zeitschriften. Die Rechte liegen in der Regel bei den Herausgebern.

Die auf der Plattform e-periodica veröffentlichten Dokumente stehen für nicht-kommerzielle Zwecke in Lehre und Forschung sowie für die private Nutzung frei zur Verfügung. Einzelne Dateien oder Ausdrucke aus diesem Angebot können zusammen mit diesen Nutzungsbedingungen und den korrekten Herkunftsbezeichnungen weitergegeben werden.

Das Veröffentlichen von Bildern in Print- und Online-Publikationen ist nur mit vorheriger Genehmigung der Rechteinhaber erlaubt. Die systematische Speicherung von Teilen des elektronischen Angebots auf anderen Servern bedarf ebenfalls des schriftlichen Einverständnisses der Rechteinhaber.

Haftungsausschluss

Alle Angaben erfolgen ohne Gewähr für Vollständigkeit oder Richtigkeit. Es wird keine Haftung übernommen für Schäden durch die Verwendung von Informationen aus diesem Online-Angebot oder durch das Fehlen von Informationen. Dies gilt auch für Inhalte Dritter, die über dieses Angebot zugänglich sind.

III b

Design and execution of welds with special consideration of thermal stresses.

Berücksichtigung der Wärmespannungen bei der baulichen Durchbildung und Herstellung geschweißter Konstruktionen.

Disposition et exécution des constructions soudées en tenant spécialement compte des contraintes dues aux variations de la température.

Leere Seite
Blank page
Page vide

IIIb 1

The Influence of Metallurgical Factors on the Safety of Welded Structures. (Stresses and Cracking Tendency.)

Zur Frage des metallurgischen Einflusses auf die Sicherheit geschweißter Bauwerke. (Spannungen und Rißneigung.)

L'influence de la composition métallurgique sur la sécurité des ouvrages soudés. (Contraintes et tendance à la fissuration.)

Prof. Dr.-Ing. E. H. Schulz,

Direktor des Forschungsinstitutes der Vereinigte Stahlwerke A.-G., Dortmund.

It may be laid down as a first principle that the reliability of welded structures depends mainly on the design and execution of the welds. In addition, large demands are made on the metallurgist as regards the mechanical properties of the structural steels supplied by him, especially those steels which are heavily stressed, and strict conditions are imposed as to the composition of the latter. Even if the influence of the steel maker on the safety of the structure may appear limited, there is, nevertheless, evidence of a relationship between the chemical composition of the steel and the development of stresses, as well as the tendency to cracking in a welded structure. Here it should be emphasised that such evidence, to be of practical use, can only with difficulty be obtained through laboratory experiments, as the conditions are too complicated. Much has been achieved, however, through practical observation and experience — that is to say, methods which are of real practical use and which throw light on the nature of the steel alloys to be employed — and this knowledge has been won through an intensive and sustained collaboration between metallurgists, welding technicians and designers, continuously and exhaustively applying the results of modern research in all relevant fields.

There is an important consideration which arises in reference to this question, a principle which plays an important part in almost every branch of the application of steel, but which is too often insufficiently observed. The principle is as follows: the higher the grade of the steel — in other words, the greater its utility, and the better it is made — the greater the care with which it must, as a rule, be treated in the later stages. An example is ready to hand: St. 37, which is as simple a material as could be as regards composition and method of manufacture, admits of being worked and heat-treated, etc. within much wider limits than was permissible for St. 48 (a material which has since disappeared from use), even though the latter represented no very great advance over St. 37 in the

development of structural steels from the point of view of their stress capacity. From the metallurgical point of view the step to St. 52 was a much greater one, for whereas St. 48 was still purely a carbon steel, St. 52 is alloyed. For this very reason St. 52 must be regarded as a more sensitive material in welding. It follows that in the construction of welded structures using St. 52 the rules of correct welding design and of careful welding workmanship must be even more strictly adhered to than with St. 37.

As regards the metallurgy of St. 52, it is further to be noticed that different compositions and different methods of alloying are practiced in different steelworks, but when comparative experiments are made and differences are discovered in the performance of two kinds of St. 52 these cannot always be attributed to differences in composition or alloying. There can be no doubt that apart from differences in these respects an important part is played by differences in the melting and working procedure which obtains in the different steelworks as a consequence of differences in their equipment and general methods. These are influences which cannot all be identified in the finished steel.

The experience available in the author's institution regarding the connection between the performance of welded structures and the metallurgy of the steel employed has reference mainly to two kinds of St. 52; one alloyed for the most part only with silicon, the other also with chromium and copper. In the last mentioned, which is the Union-Baustahl, the silicon and manganese contents also, of course, play a part. The experience available in respect of the chrome copper steel is much richer than that with the silicon steel, as the preparation of the latter was very soon found to be exposed to grave defects. For this reason the author's information is based mainly on experience with St. 52 alloyed with copper and chromium.

Moreover, it is perhaps a matter of some importance that this experience has not been derived from a single source concerned only with some particular aspect, but constitutes a summary of experience obtained in the steelworks, the welding workshop and the bridge fabricating shop in collaboration with the Research Institute of Kohle- und Eisenforschung (Vereinigte Stahlwerke).

There are two ways in which the chemical composition of St. 52 would appear to be important as affecting the stress conditions and susceptibility to cracking in welded structures.

It is known that welding gives rise to stresses in the structure which may, in certain circumstances, result in additional stresses difficult to control, and may lead to fractures. The question arises how far the composition of the steel may influence the magnitude of these welding stresses: for it is not reasonable to suppose that notable stresses arise with one kind of steel under certain conditions and none at all with another kind, and the question can, therefore, only be one of difference in the orders of magnitude of the stresses.

An important criterion for the development of these stresses would appear to be the hot yield point of the steel, and this depends in turn on the nature and quantity of the added alloying components. Yet, in another field of work, that of the construction of heavily stressed boilers, it has been found possible to increase the high temperature strength by suitable alloying, to a quite remarkable extent compared with the strength of the ordinary carbon steel. It might have

been supposed that as a rule the stresses arising in the welding operation would increase as the hot yield point was increased. Yet careful stress measurements, carried out on the chrome copper steel used by the author, disclosed practically no higher stresses, even under a great variety of experimental conditions, than were found in St. 37, despite the greater high-temperature strength of the former.¹ In one series of experiments, indeed, the stresses in St. 52 were found to be less than those in St. 37: but this result was not found to be generally valid. In no case, however, was a stress found to exist which might be regarded as dangerous by comparison with that in St. 37.

Conditions from the second point of view are somewhat more complicated.

In welding, the zones close to the weld seam are heated to a very high temperature, and if the thickness is considerable the large amount of heat produced in these zones is very rapidly conducted away by the neighbouring cold zones. In other words, an effect may be produced in the highly heated zones which corresponds, or at any rate approximates, to sudden quenching. In this way "hard spots" may be produced in the welded construction, and these hard spots are brittle. It is true they may have a high tensile strength, but under bending stress they tend to crack. Indeed, the hard spots may by themselves lead to cracking, on account of the volume changes which attend the transformations even without the presence of any external load.

The hardening capacity of St. 52 would appear to depend in the first place on its *carbon content*. In accordance with the relevant regulations of the German Reichsbahn the carbon content in St. 52 is limited to 0.20 % for thicknesses up to 18 mm and to a maximum of 0.25 % for still greater thicknesses, this being done in direct reference to weldability. There might be other inducements to the metallurgist to increase the carbon content, especially since strict compliance with the limits imposed thereon makes it difficult to obtain the prescribed yield point (minimum 36 or 35 kg/mm²). All our experience, however, is to the effect that with due regard to the safety of welded constructions the limit 0.20 % of carbon should not be exceeded. As early as 1933 *Buchholtz* and the author showed that the hardening capacity of the parent material, and especially its carbon content, has much influence on the fatigue resistance of welded St. 52.² Thus welded connections made with St. 52 containing 0.24 % of carbon were 20 to 30 % less strong than those made of St. 52 showing the same mechanical strength but containing 0.16 % of carbon. We established the fact that it is desirable, where possible, that the carbon content should not be allowed to exceed 0.18 %. It should be clear, however, that a limit on the carbon content — and still more, as will be explained below, on the other alloy constituents — is to some extent bound to be detrimental to the yield point.

The part played by the other alloy constituents in St. 52, from the point of view of weldability, is more difficult to ascertain, and the conditions in regard to *silicon* appear particularly complex. Silicon in itself does not tend to any great extent towards an increase in hardening capacity, but the dislike of most steelworks for a pure or only slightly altered silicon steel is due to other reasons.

¹ *H. Bühler* and *W. Lohmann*: *Elektroschweißung* 5 (1934), p. 226.

² *Stahl und Eisen* 53 (1933), p. 545/52.

In spite of this, the silicon content has for some time been limited to a maximum of 0.4 %, and the author would wish particularly to emphasise that this is so despite the preparation of a large number of meltings with a higher silicon content, approximately 0.6 %. It was quite obvious, however, that the steelworks experienced difficulties with this high silicon steel, with the result that the limit of 0.4 % is now strictly adhered to.

The maximum content of *manganese* which we allow is 1.1 %. According to the experience of some other works 1.5 % is permissible, but doubtless only with a correspondingly smaller content of other alloy constituents. In this connection it may be mentioned that according to *Sandelowski*,³ and also according to *Schulz* and *Püngel*,⁴ electrodes with a high manganese content tend to a greater amount of shrinkage in the seam and greater stress in welding.

Copper is added to the Union-Baustahl up to 0.8 %, without any difficulties or disadvantages from the point of view of the safety of welded connections being disclosed. In this connection it is of interest to note a recent publication by *S. Epstein*, *I. H. Nead* and *I. W. Hally*,⁵ who, in attempting to develop a weldable steel with a good strength at high temperatures, arrived at the following composition:

	C	Si	Mn	Cu	Ni	P
Maximum:	0.10	0.15	0.50	1.00	0.5	0.12

Here the limit of carbon content is very much reduced. The manganese and the silicon are also kept low, while a copper content of 1 % is regarded as advantageous. The high content of phosphorus is also of interest from this point of view.

The presence of *chromium*, when it exceeds certain limits, gives rise to undesirable effects in welding, and chromium also tends to hardening. Regarding this matter of the influence of the chromium content we are in possession of very extensive observations, and from these the rule has been laid down that the chromium content should not be allowed to exceed 0.4 %. Up to this limit, the presence of chromium has not given rise to any difficulties. In other works a higher limit is allowed, and mention may be made particularly of the British Chromador steel, wherein, to the author's knowledge, the chromium content is as much as 0.8 %. It would be of interest to learn what experience has been obtained in the welding of this steel.

Molybdenum, within the limits that it is present in St. 52, may doubtless be ignored from the point of view of the quality of welds.

In reproducing the chemical composition proposed by *Epstein* and his collaborators special attention was drawn to the phosphorus content, which reaches the high value, according to our ideas, of 0.12 %. We now know, on the basis of work carried out in our own company, that very often the phosphorus content of steel is not attended by the grave disadvantages which are frequently ascribed

³ Elektroschweißung 2 (1931), p. 48/53.

⁴ Stahl und Eisen 53 (1933), p. 1233/36.

⁵ American Institute of Mining & Metallurgical Engineers, 1936, Technical Publication No. 697; Metals Technology, 1936, Vol. 3, April.

to it, but that on the contrary, under certain conditions, it may be regarded as a useful and desirable element. For our steel St. 52, the author would not indeed regard so high a phosphorous content as in the American steel as desirable⁶: but to say this is not to imply anything against the American steel, for it would appear that the danger from phosphorus decreases in proportion to the carbon content, and in the American steel the latter is very low. It would be of great interest to learn more about the behaviour of this American steel in welding.

In the German St. 52 the phosphorus content is manifestly so low, since it is a basic Siemens-Martin steel, that as regards the performance in welding and on the site no difficulties can arise through its presence. The same is true in regard to the sulphur content.

Addendum.

While the report was in the press, regulations were issued by the German Reichsbahn allowing increased amounts of alloy in St. 52, the main object of this being to obtain a better guarantee of weldability while at the same time approximating the various kinds of St. 52 more closely to one another as regards composition. In accordance with these regulations the following upper limits are laid down for the alloy constituents:

Carbon	maximum 0.20 %
Manganese	maximum 1.20 %
Silicon	maximum 0.50 %
Copper	maximum 0.55 %.

In addition to these constituents the St. 52 may receive a further addition of either chromium up to a maximum of 0.40 % or of molybdenum up to 0.20 %. Finally, an additional manganese content of 0.30 % may be present, bringing the total content of manganese up to 1.50 %, but only in the absence of either chromium and molybdenum.

At the same time, however, the prescribed minimum yield points in respect of the greater thicknesses were stepped down.

⁶ K. Daeves, A. Ristow and E. H. Schulz: Stahl und Eisen 56 (1936), p. 889/99 and 921/27.

III b 2

Stress and Distortion Due to Welding.

Schweißspannungen und Verwerfungen.

Contraintes internes et distorsions provoquées par la soudure.

W. Heigh,

Welding Superintendent, Babcock & Wilcox, LTD., Glasgow.

One is apt to glean from the leading papers in this discussion that welding in its present state is a very inexact science. There are too many doubts and fears — too many unknown factors.

Those of us who are concerned chiefly with getting work done cheaply, quickly and well, detest the unknown and avoid it at all costs.

Some reassurance seems to be necessary.

For example, the fear is expressed in one of the papers that the weld metal may be in a dangerously chilled condition and that it is liable to be dangerously stressed.

Since the weld metal obtained from certain good and quite cheap covered electrodes is consistently ductile, no real danger exists. An elongation of 22 to 25 % on a gauge length of four diameters is commonly obtained in the as-welded condition.

Dangerously chilled metal could not be so ductile, while with so much stretch left in the weld metal the stressed condition is much less important than it seems.

We are also warned to be careful of the stressed condition in the parent material — the metal in the pieces being joined together.

But rolled steel sections and mild steel plates are almost invariably cold straightened before being applied to important structures and are therefore in a stressed condition. Hundreds of very high self-supporting steel chimneys (that is, chimneys without guy-rope supports) sway in high winds over populous workshops and cities; yet no one thinks of excessive danger to life although all the plates have been cold rolled and therefore stretched far more than any weld-stretched piece of metal.

If inequality of stress distribution is feared, the analogy of hot bent rolled sections is a comfort. Those are used freely in important structures, yet the fact that most of the bends are made by local heating and forming leaves the metal in a condition precisely similar to that in a weld and the surrounding material.

Speaking practically, all those fears may easily be exaggerated. If a good electrode and a sound welding procedure are chosen and if the chilling effect

of large masses of material, very cold weather and weather-exposed welding positions are allowed for by slight preheating welding may be used with full confidence.

It is, of course, an advantage to relieve the stresses by heat treatment and in certain cases, notably in thick welded pressure vessels, stress relief is a normal part of the manufacturing procedure. Apart from the extremely high pressures frequently involved (a sufficient argument for special treatment) the stressed condition of the cold formed thick plates and the locked condition of many of the welds in pressure vessels are such as are seldom if ever met with in structural work.

From another point of view, the desire is general in design offices and workshops for quick safe rules for the control of distortion in the final shape of a structure. Some suggestions are offered by the leaders in this discussion. Possibly those which follow will add something of value. Distortion in those notes refers

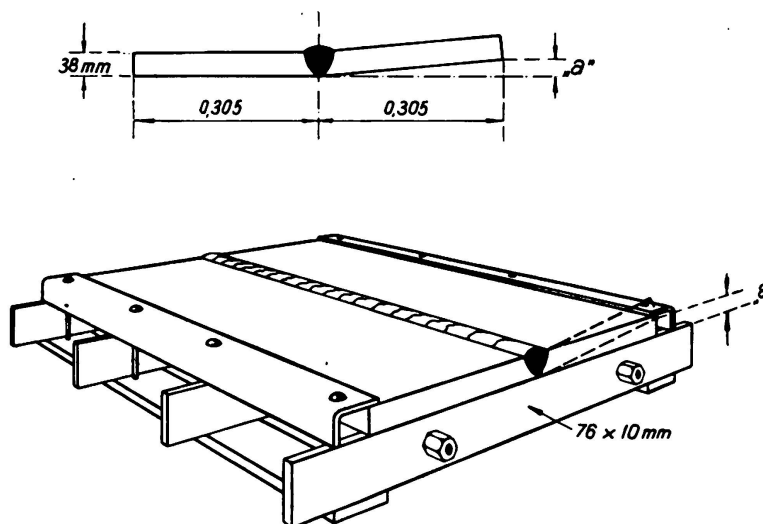

Fig. 1.

to the visible change of shape, not to the displacement within the material which is its root cause.

1) Clamping need not be rigid to be effective. For example, Figure 1 shows two test plates in position in a clamp designed to reduce the distortion. Welding the plates free, dimension "a" was 1" (25 mm). Welding the plates in the clamp, dimension "a" was reduced to $\frac{3}{16}$ " (5 mm).

The moment of resistance of the clamp was one quarter that of a weld of plate thickness, or equal to the resistance of a plate one half the thickness being welded.

No resistance (except friction) was offered to the transverse contraction. This is deemed important.

The flats of mild steel were of such a length that the angular movement due to the shrinkage of each run of welded did not strain the flats beyond the elastic limit.

The principle of the clamp has many applications and has been used freely with success.

2) Size of electrode and method of deposit used are of importance.

Figure 2 illustrates three conditions in a butt weld.

- a) N° 8 w. g. electrodes (4 mm diameter) bead runs, gave an angular distortion of 8° .
- b) $\frac{1}{4}$ " (6,3 mm) diameter electrodes, bead runs, gave an angular distortion of 4° .
- c) $\frac{1}{4}$ " (6,3 mm) diameter electrodes, woven layers, gave an angular distortion of 3° .

A further test in a clamp gave an average angular distortion of only $1^{\circ} 11'$.

Tests a) and b) were repeated with fillet welds with somewhat similar results.

Large electrodes certainly reduce this very troublesome type of distortion. It is also important to add that welds a), b) and c) were all submitted to mechanical tests and met the requirements of the American Fusion Welding Code for Pressure Vessels so that in this sense the welds were of equal value.

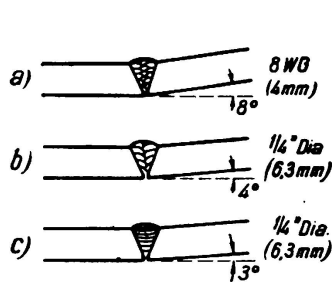

Fig. 2.

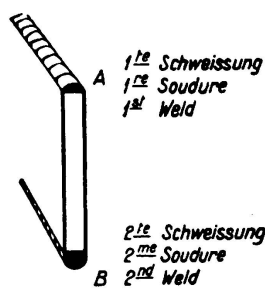

Fig. 3.

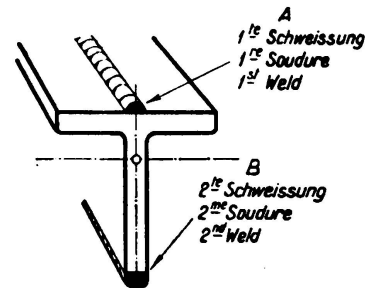

Fig. 4.

3) Rotation of welding assists in reducing distortion.

- a) Approximately equal effects are obtained by running two welds, placed symmetrically at an equal distance from the neutral axis of a symmetrical section, simultaneously.
- b) If a first run of welding distorts a symmetrical section, a first run of double the volume on the opposite side or edge will approximately balance the first distortion. Figure 3 illustrates a simple test to check this. In multiple run welds distortion from later runs requires a much greater opposing effect.
- c) The first in order of two welds in an asymmetrical section as illustrated on Figure 4 should be that nearest the neutral axis.

With training, assemblers and welders acquire considerable skill in checking and controlling distortion. For important non-recurring work, however, the assembly should be planned beforehand and a check kept as the work proceeds so that rotation of welding may be changed, as is found necessary, to correct distortion and keep the assembly in shape.

IIIb 3

Internal Stresses in Welded Joints.

Innere Spannungen in geschweißten Stößen.

Efforts internes dans les joints soudés.

J. Orr,

B. Sc., Ph. D., Glasgow University.

The lecturers have given very thoroughly the disturbing effects of welding in producing distortion and internal stress. They have also spoken on the danger of cracking and of the need for further investigation on the actual weakening effect of the disturbances due to heat and of the internal stresses. Our experience is that the danger of cracking is the cause for real anxiety.

Internal Stress. The writer carried out a series of tests on mild steel and on steels of higher tensile strength (37—43 tons/in.²), the increase being obtained by small additions of carbon, manganese and chromium. They were interesting in that a comparison was made of the welded specimen in the unannealed state with the specimen annealed by heating for a few hours at 600° C. In the latter case the internal stresses are removed so that the tests detected any effect due to internal stress.

The tensile strength and the impact value of the joint were reduced a little by annealing; the fatigue strength obtained in a machine capable of testing the complete joint, remained the same; the bend test for ductility in the butt joints showed an improvement in the annealed specimens, but several of the electrodes used gave welds satisfying the standard bend test in the unannealed state. The conclusion from these tests is that internal stresses adjacent to the weld are not a weakness, practically speaking, if good electrodes are used.

Tests on the value of residual stress.

A series of tests was carried out by the writer to find the actual value of internal stress in a severely constrained condition. The arrangement is shown in Fig. 1. Two 1/2" plates prepared for a butt weld, were first welded to a 3" thick plate at their ends. They were then welded together. After mounting a tensometer, the plates were sawn through. The reading on the tensometer gave the release of strain and therefore the amount of residual stress. The results were as follows, as shown in Table 1.

Table 1.

Specimen	Length X ins.	Welding	Residual Stress tons/in ²
1	9	With $\frac{3}{16}$ " rods	12.0
2	58	" $\frac{3}{16}$ " "	4.2
3	9	" $\frac{1}{8}$ " "	13.0
4	58	" $\frac{1}{8}$ " "	7.2
5	9	Hammered hot	cracked
6	9	" "	5.0
7	9	" cold	4.5

The first point of interest in this table is the effect of the length of plate. Increasing the length of plate reduces the stress and emphasizes the point made by the lecturers that there should be flexibility in the part bordering on the welded seam, in this case it is the flexibility of the long plate.

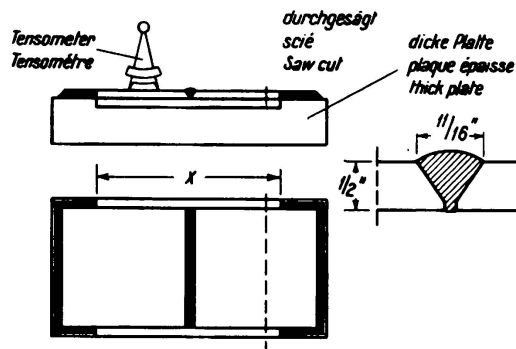

Fig. 1.

Contraction Stress in Butt Welds.
(Plates Welded at Ends Before Butt Welding.)

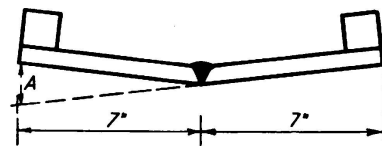

Fig. 2.

Angular Distortion in a Single-V Butt Weld.

The second point is the effect of larger compared with smaller electrodes. These results agree with those quoted by the lecturers, that the larger rods produce less residual stress.

The third point is the effect of hammering, which certainly reduces the stress, but increases the danger of cracking. From later tests using a wide variety of different makes of electrode, the writer is of the opinion (1) that only a few electrodes give weld metal capable of being hammered without the danger of cracking, (2) that the first run of welding should not be hammered as it was shown from hardness tests to be a danger spot and where welds failed, the cracks started from this part, and (3) that the outer layer should not be hammered.

Tests on angular distortion of a single-V butt weld.

These tests are of interest in showing the effect of a small amount of restraint. The restraint was obtained by placing two weights on the plates as shown in Fig. 2. The distortion "A" was measured after cooling and is given in Table 2.

Table 2.

Specimen	Welding	Current amps	Distortion 'A' ins.
1	5 runs $\frac{1}{8}$ " rod	110	0.28
2	3 " $\frac{3}{16}$ " "	170	0.05
3	3 " $\frac{3}{16}$ " "	220	0.044
4	2 " $\frac{5}{16}$ " "	340	0.031

Plates $\frac{1}{2}$ " \times 7" \times 7"

The restraining effect of the weights is small as it produces a calculated bending stress in the weld of only $\frac{1}{7}$ tons/in². This test confirms the effect of the smaller rods in building up a greater distortion, and therefore where the restraint is more definite, in building up a greater stress.

IIIb 4

Allowance for Temperature Stresses in the Design and Execution of Welded Structures.

Berücksichtigung der Wärmespannungen bei der baulichen Durchbildung und Herstellung geschweißter Konstruktionen.

Les contraintes thermiques dans la disposition constructive et l'exécution des constructions soudées.

Dr. Ing. K. Miesel,
Grünberg.

Professor *Bierett* draws a distinction between those shrinkage stresses which are produced by internal and those produced by external agencies — a distinction which is important not only as regards the distribution of stress in structural members, but also from the point of view of combatting the effects of shrinkage.

The internal stress can be dealt with only by making use of the properties of the weld metal and by control over the welding process, or by mechanical action such as clamping the work and hammering the seams. Annealing, which would be the most effective remedy, cannot be applied in bridge and structural work.

Difficulties from external stress can be met by due attention to the design of the structure, and also at a later stage in the construction. Recently the attention of engineers has mainly been concentrated on the jointing of plate web girders, and Professor *Bierett* shows in his paper how shrinkage may be compensated

by the insertion of a previously bent strip of plate in the web.

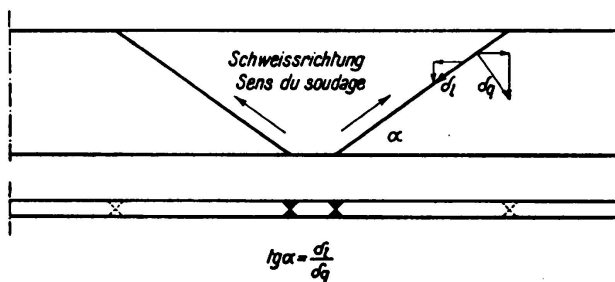

$$\tan \alpha = \frac{d_l}{d_g}$$

Fig. 1.

Wedge joint for plates.

(Schweisrichtung = welding direction).

In two large structures the flanges were connected by wedge shaped cover straps after the web had been welded (Fig. 1). The angle of bevelling was decided from the relation between longitudinal and transverse shrinkage as found by experiment. As welding was carried out from the

narrow to the long side of the wedge, the longitudinal components of the shrinkage were relieved and the transverse components were increased, with the result that the cover plate was drawn uniformly into the joint. This effect was confirmed by preliminary experiments on thin plates.

In the formation of thick flange plates for bridges it was found, however, that the expected action was soon defeated by the internal stresses which arose through the welding of the tulipshaped seams, and when these seams had been filled to

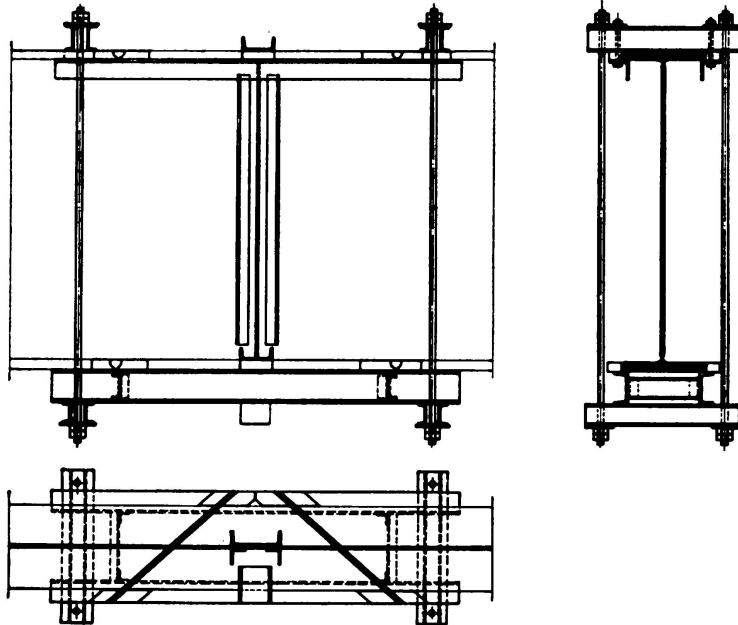

Fig. 2.
Testing arrangement
for wedge joint.
Proposal.

two-thirds of their total depth a powerful angular contraction occurred, which had to be counteracted by continually tightening the clamping on the parts to be joined. Fig. 2 shows the design of a clamping arrangement, and Fig. 3 in-

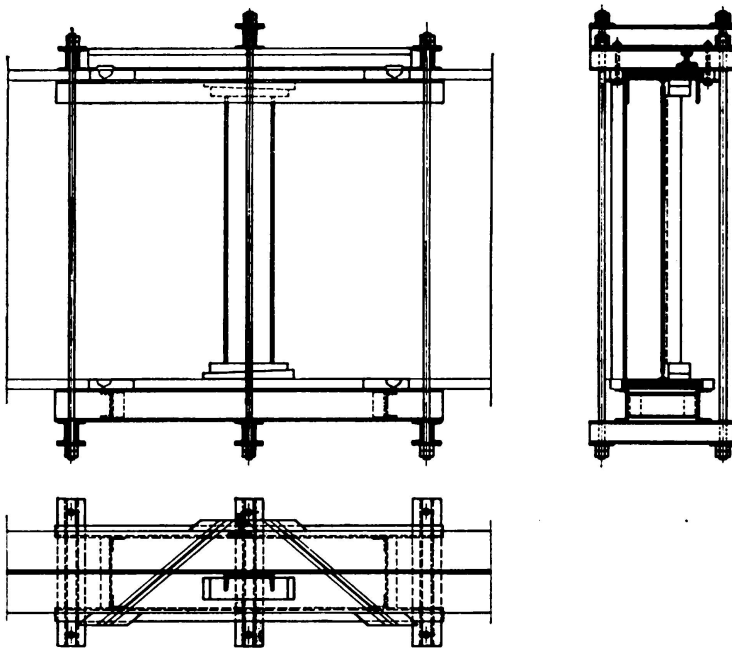

Fig. 3.
Testing arrangement
for wedge joint.
Final arrangement.

dicates how strongly this has to be constructed in order to overcome the angular distortion in welding. It was found possible to make girders of St. 37 completely free from shrinkage cracks, but in St. 52 a tendency to these was observable and

they were avoided by hammering the second half of the seam, a procedure whereby the direction of the shrinkage can be controlled. It is not yet definitely established, however, whether hammering may exert an unfavourable effect on the mechanical properties of the material.

Shrinkage cracks may also be avoided by adopting a proper sequence of operations in welding, and by pre-heating the parts. In one instance a plate girder of St. 52 was being welded in very hot summer weather when the operation had to be interrupted on account of a hailstorm, and the sudden cooling of the thin web plate, connected as it was to the much thicker flanges, resulted in this being torn away over the whole length of an incompletely welded joint. The latter was re-welded after preliminary heating, and by this means a perfect new weld was obtained.

It may be inferred from a number of publications that the chief part in avoiding shrinkage stresses is played by the designer, but, as these examples show, he is powerless against internal stresses. The external stresses may be reduced by the adoption, where possible, of sufficiently resilient connections. There should be no hesitation in preferring rivetted connections in situations where excessive shrinkage effects are to be apprehended and where rivets are not entirely ruled out by aesthetic considerations. It is a matter in which the demands of the architect may frequently be in conflict with the clear obligation of the engineer not only to secure the most economical arrangement of structural parts, but to combine this with safety and efficiency. Where rivetted connections

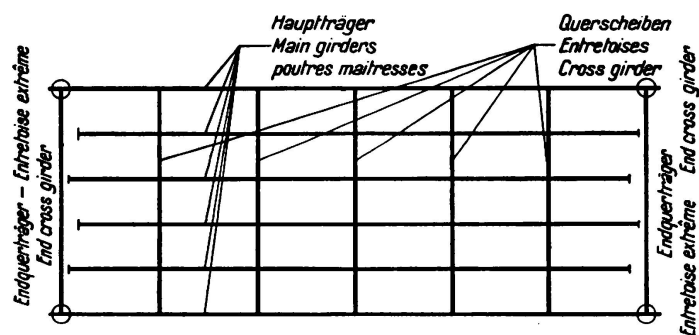

Fig. 4.

Shrinkage of main girders of a grated bridge.

are so used they may be regarded as playing much the same part as the discontinuities which are introduced into reinforced concrete structures on account of shrinkage effects.

Fig. 4 is a diagram showing a bridge floor in which the main and cross girders were welded on the site. The shrinkages accumulated to different totals on either side of the end cross girders, and this being the case it was found expedient to make the connection between the main girders and the end cross girders by means of rivetting. In this way the cross girders in question are not restricted as to position, and a more accurate alignment of the track is obtained.

Special difficulties attend the construction of members wherein the shrinkage effects are two or three dimensional. Fig. 5 shows the framed main girder of a bridge, and to a larger scale the corner of the frame. The static stresses at different sections are indicated in the diagram, and the heaviness of the loads which have to be transferred by the fillet welds from the flanges on to the web is made apparent. The excessive thickness which had to be given to these fillet welds was especially conducive to cracking, especially since St. 52 was being used, and such cracking can as a rule only be avoided by hammering.

In this instance, as is true of web plates in general, the shrinkage stresses may lead to bulging, or what is even more dangerous, may be superimposed on other stresses so as to cause failure of the plates. It is to be recommended,

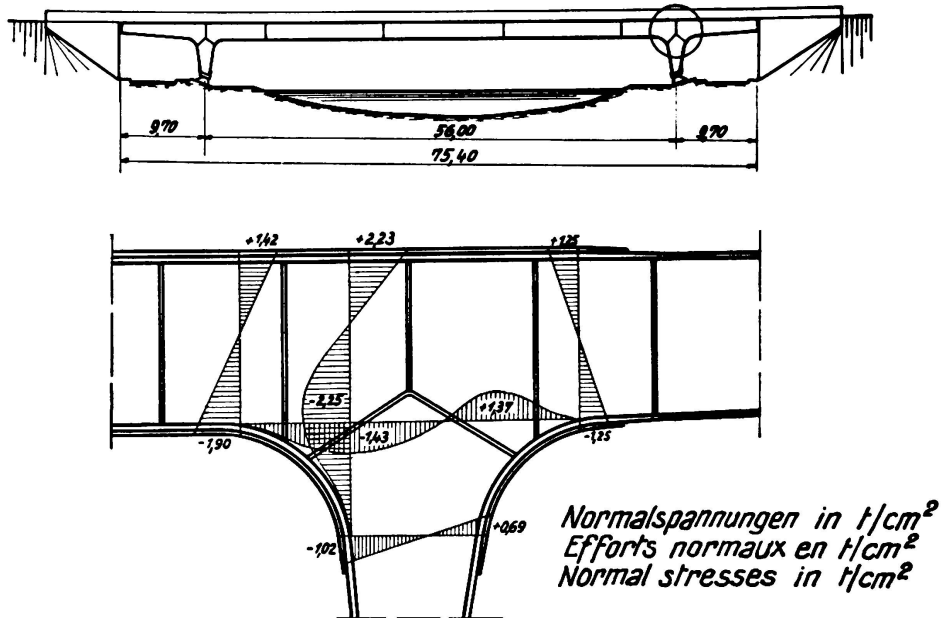

Fig. 5.

Static stresses in frame connection.

therefore, that in the region where the shrinkage stresses occur the stiffeners should be designed to carry the same longitudinal and transverse loads as would occur in a framed girder assumed to take the place of the plate web girder, and should not merely be dimensioned for the degree of stiffness required by the buckling theory.

Observations and measurements carried out in reference to distortion agree in indicating that the shrinkage stresses due both to external and to internal effects may approach the elastic limit. The experimental apparatus shown in Fig. 6 was used for the purpose of measuring shrinkage stresses due to external loading. The test pieces, to be connected by a V seam, were held in place during the welding process by pins fixed into a thick piece of steel, so as to prevent any movement. The free end of the specimen was held in the testing machine and was subjected to tension until it became possible to withdraw the pins by light hammering, thus indicating that the whole of the shrinkage stresses had been

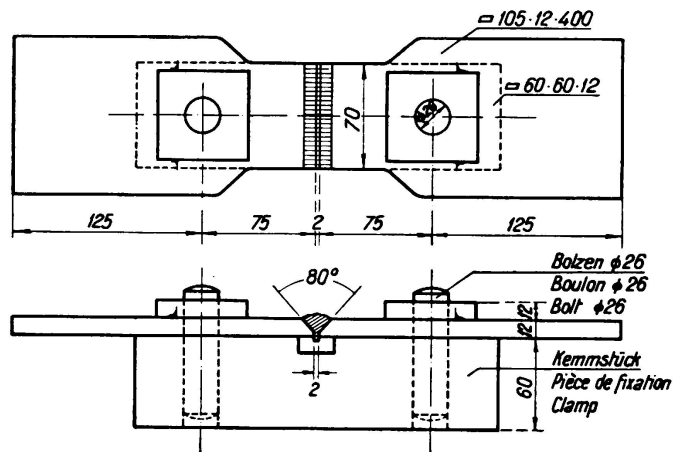

Fig. 6.

Arrangement for measuring shrinkage stresses.

transferred from the pins to the machine. Fig. 7 shows the shape of the stress-strain curves obtained for St. 37 and St. 52, the shrinkage stresses being in the neighbourhood of the limit of elasticity. This also occurs when the specimens are repeatedly loaded and unloaded within the range of the stress that will arise in practice, namely 1.4 to 2.1 tons per sq. mm, before making the experiment. If the specimens are stretched by only a small amount in excess of the shrinkage stress value first measured, the shrinkage stress obtained on a second attempt amounts to only 50 to 75 % of the first value. The values which correspond to this higher degree of tenacity correspond to the upper limit for St. 37 and to the lower limit for St. 52. In this case it could even be observed that the steel

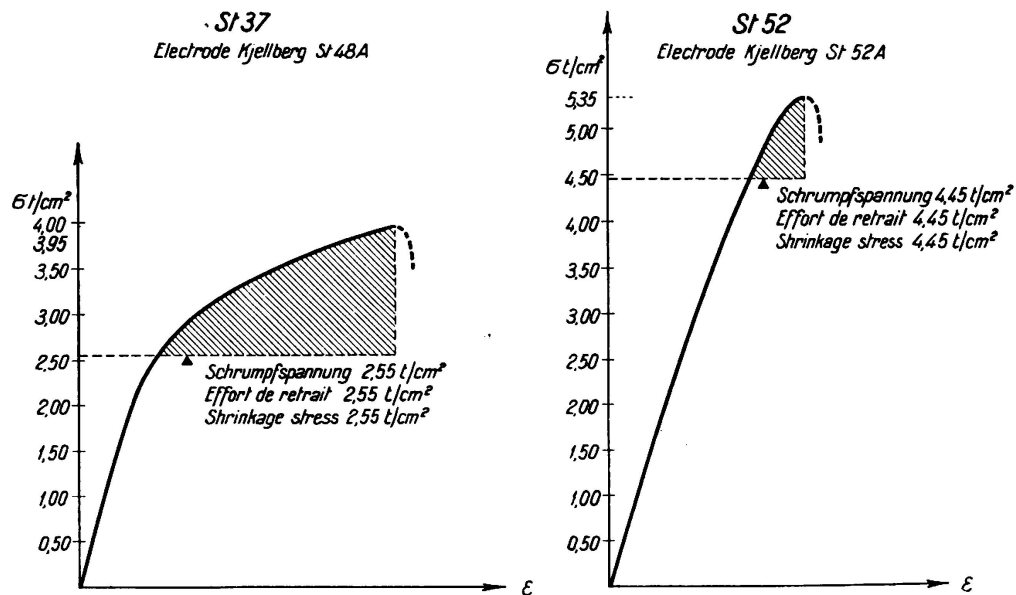

Fig. 7.

Elongation diagrams for shrinkage stresses.

requires a certain amount of time to take up its shrunken condition. The reserve of strength which remains after taking up the shrinkage stresses is usually adequate in the case of St. 37 but is very small for St. 52, and this accounts for the greater susceptibility of the latter to cracking.

Under external static loading, shrinkage stresses after welding are no more dangerous than other dead load stresses, but stresses which cause unstable equilibrium form an exception to this statement. Additional shrinkages due to neighbouring welds, or new internal stresses due to temperature effects, may lead to cracking, and this occurs more readily in St. 52 than in St. 37 on account of the smaller margin of stress and elongation possessed by the former.

It would be desirable to carry out fatigue tests using the experimental apparatus shown. Pre-stressing, in the sense the term is applied to ordinary fatigue tests, is present only if the loading acts in such a way as to counteract the shrinkage stresses. In such a case the fatigue strength must approximate to the elastic limit, and the available amplitude for butt welds, according to the fatigue tests carried out by the relevant German Commission,¹ amounts to 10 kg/mm²

for St. 37 and 13.1 kg/mm^2 for St. 52. According to German regulations when $\gamma = 1$ this requires a value of α of approximately 0.65 for St. 37 and approximately 0.58 for St. 52. Where the shrinkage stresses are of the same sign, and usually also when they are of opposite sign, there can be only one distribution of stress in the member for which the fatigue strengths may be at a maximum but require to be determined in each case.

Thermal stresses still frequently offer difficulties to the engineer both in the drawing office and in the workshop. It may be hoped, however, that research and experience may in the near future, lead to welding processes being so far perfected that shrinkage stresses will cease to offer any more difficulty than secondary stresses in rivetted work.

¹ Dauerfestigkeitsversuche mit Schweißverbindungen (report of the commission on fatigue tests in the welding technical committee of the Verein Deutscher Ingenieure), p. 27 and 35—37.

IIIb 5

Temperature stresses observed in welded constructions in Belgium.

Bei Schweißarbeiten in Belgien festgestellte thermische Beanspruchungen.

Contraintes thermiques constatées lors des travaux soudés en Belgique.

A. Spoliansky,

Ingénieur des Constructions Civiles et Electricien A.I.Lg., Liège.

This note will be limited to a consideration of thermal stresses, regarding which it may be observed that although we do not know their exact magnitude we do know, only too well, that it is considerable. As a single example in support of this fact mention may be made of a Vierendeel girder wherein no special precautions had been taken, as they should have been, to relieve the thermal effects of the thick weld seams of 36 mm side: when the last site weld was being formed the end of the bridge was observed to be lifted off its bearing, and a fold appeared in the lower boom. In this instance the weight of the longitudinal member in question was approximately 80 tons.

Elastic action appears in the following forms:

- 1) Shortening of the members.
- 2) Deformations.
- 3) Internal stresses, which may or may not be attended by cracking and breakage.

1) *Shortening of members.*

Members are shortened as a result of shrinkage from welding, but by making the members slightly longer than necessary it is possible to ensure that the final dimensions are sufficiently accurate.

2) *Deformations.*

Deformations are more especially apt to be considerable at places where the weld seams are asymmetrical. Any given deformation is proportional to the free length of the member in question, where the latter is able to deform in the direction of the seam, and it is inversely proportional to the thickness of the member. Most of the welded bridges in Belgium are Vierendeel girders with

a parabolic upper boom, and since this boom is in compression there is every advantage in making it as stiff as possible. There are two methods of doing so:

- a) The use of double T girder having its flanges in the form of standard rolled joists 400 to 500 mm deep, or broad flanged beams (Fig. 1). Technically, from the point of view of welding, the second of these methods is open to the objection that the weld is formed on the web of the joist which is of limited thickness, so that the deformation is considerable. Moreover, most of the methods commonly used in the workshop for straightening bent pieces when cold are dangerous: for instance, in certain shops where joists used for booms of girders had been straightened cold, a series of cracks were found running at right angles to the weld in the web, due to a partial cold working effect on the metal (Fig. 3).

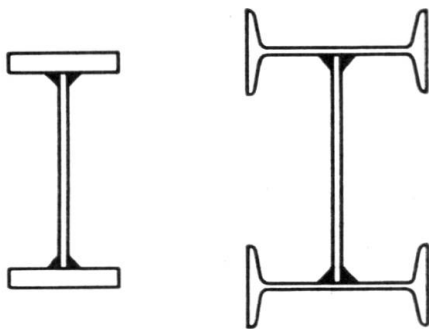

Fig. 1.

Types of booms for Vierendeel bridges.

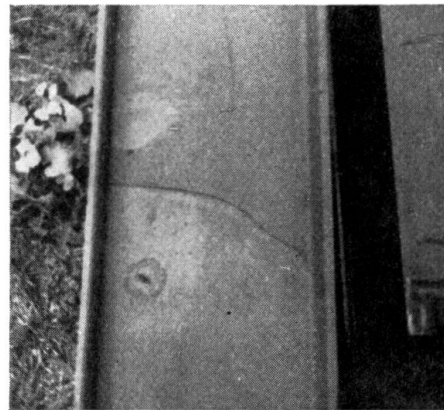

Fig. 2.

Fractured beam of an upper boom of a Vierendeel bridge.

The amount of these deformations can and should be reduced by suitable choice of

- a) The thickness of the pieces to be joined, and
- b) The sizes of electrodes to be used.

For this and other reasons, electrodes of large diameter should be avoided, especially for the first layers. In most cases deformations can practically be eliminated if a symmetrical arrangement of the beads is adopted.

In Vierendeel girders and rigid frames, such as are becoming general in Belgium, use is being made of connecting gussets having a section built up from a web with a flange (Fig. 3). Such gussets may be formed from four flanges b), with symmetrical beads, or with two flanges a). The arrangement shown at b) is evidently to be preferred, but it calls for a large number of welds. In box-shaped members (Fig. 4), notwithstanding the symmetry of the welds, a twisting effect has been observed, due partly to the amount of metal deposited in the different beads not being precisely equal and partly to the fact that the elements themselves are not precisely similar.

3) Internal stresses.

The shrinkage of welds gives rise to stresses extending over a considerable zone, and these may be dangerous especially where there already are pre-existing stresses. For instance, in rolled sections of great thickness the deposition of a weld bead may have the effect of causing fracture, and in Belgium breakages have often been found in Grey beams which, as is well known, are subject to

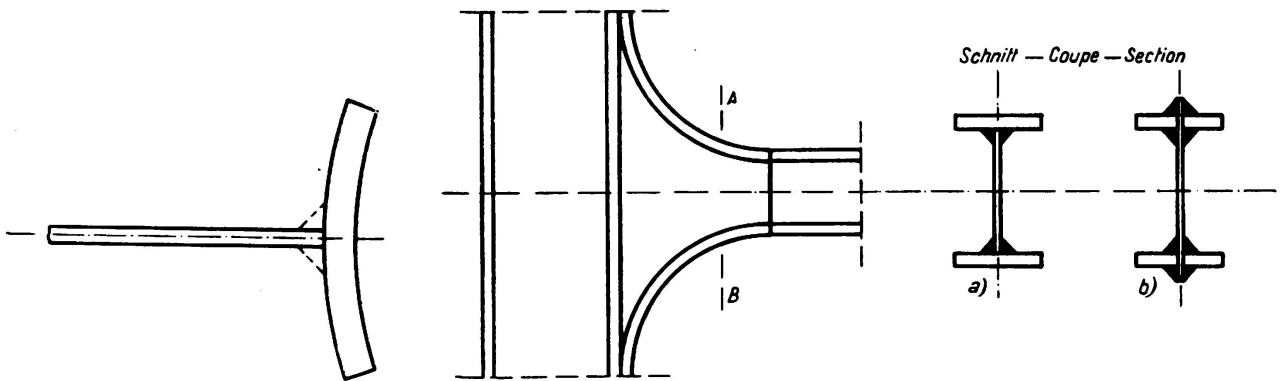

Fig. 3.

Inverted camber given to a welded plate.

Fig. 4.

Details of panet point with tangential jointing.

heavy rolling stresses. The drilling of a hole may render a rolled piece unsuitable for welding because of the interruption of the cold worked zone, giving rise to cracks and breakage in the sound part of the piece. The crowding of many weld

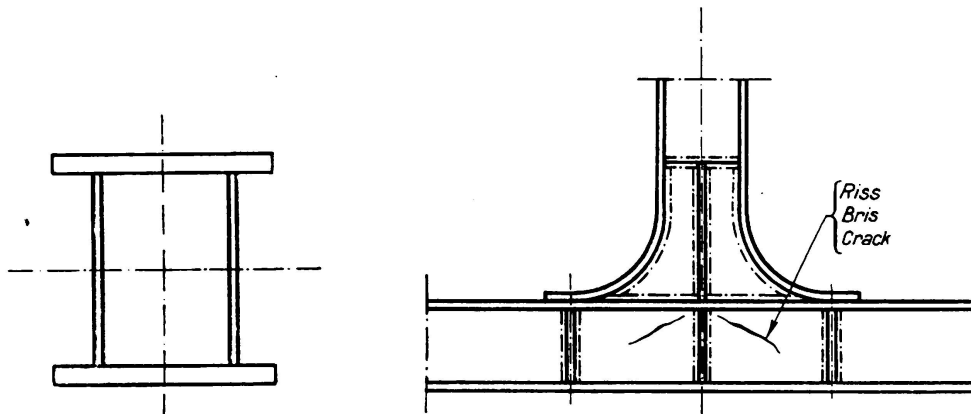

Fig. 5.

Welded box girder.

Fig. 6.

Details of panet point with characteristic cracks.

beads into a small space should be avoided, and in the same way it is desirable to avoid placing welds of widely different dimensions close together.

In Belgium there have been cases of accidents arising in the welding of the bracings to the intersections in Vierendeel girders with a number of stiffeners (Fig. 7), and also in the welding of the cruciform-sectioned verticals of these bridges (Fig. 8). In plate web girders the stiffeners are a source of great trouble, and if it were possible to diminish their number by suitably increasing the thickness of the web the design of such bridges would be improved. Another evident improvement in the design of stiffeners would be to continue them as far as the tensile boom (Fig. 9).

The chief danger attending the presence of these thermal forces is that any resulting cracks or breakages may not appear in the workshop immediately after the welding operation. Microscopic cracks may then be imperceptible, and escape detection until some months later: a form of delayed action which is peculiar to welding and which has never been completely explained. The effect may perhaps be similar to that sometimes observed in accidents to cast pieces where, likewise, the breakages have occurred at unexpected places.

An instance occurred in which the presence of a large number of cracks in the parent metal and weld metal was disclosed in the course of alterations to a girder of double T-section when a welded plate was being cut out with the blowpipe (Fig. 10); these cracks were probably due to mill scale on the plate.

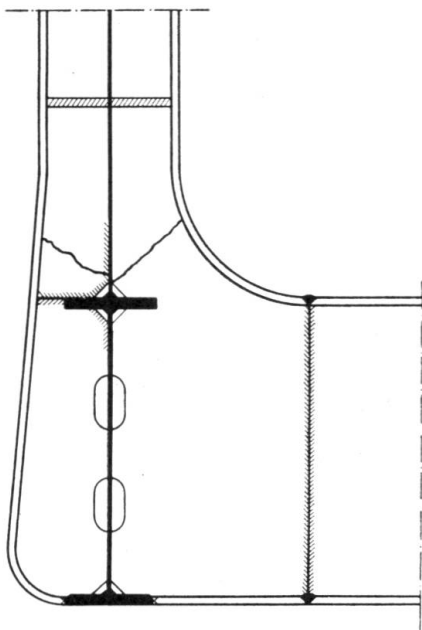

Fig. 7.

Characteristic cracks in uprights of Vierendeel bridges.

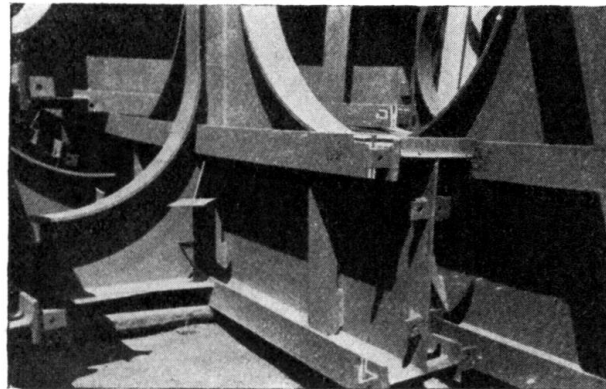

Fig. 8.

Connection of cross girder and standard.

Another example worthy of mention is the following: some months after the welding of a bridge had been completed and the concrete decking had been laid down a sudden breakage occurred along the axis of the welded joint of the web, accompanied by a noise (Fig. 11). In the author's opinion the shrinkage stress in the seams of the flanges, which were 36 mm thick, had been sufficient to initiate cracking in the bead along the web.

Precautions to be taken to reduce the effects of thermal stresses.

Advance precautions.

A) *Positions and dimensions of welds.*

Welds should be so placed as to receive a minimum of stress under all conditions, and their close proximity to one another should be avoided. The proper detailing of connections is a matter of the first importance to which, in Belgium,

a great deal of consideration has been given and this has led to the perfecting of a curved form of joint with tangential connections, which is suitable for use both in bridges and in building frames. Mons. *Campus* has described this form of joint before the present Congress.

B) *Dimensions of the members to be joined.*

The thickness and length of the members must be carefully proportioned, and for the following reasons the thickness of plates should not be below a certain minimum:

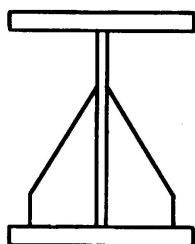

Fig. 9.

Stiffener to a single web beam.

- 1) It has been found that in thin sheets at temperatures of 600 to 800° C the elongation is considerably reduced, with a consequent increased tendency to cracking.
- 2) Excessive penetration of the welding is to be apprehended, and this, from an operating point of view, fixes a minimum thickness.
- 3) To minimise warping.
- 4) To reduce the number of stiffeners.

C) *Sequence of welding.*

The sequence in which the various beads are deposited should not be left to the decision of the welder, but should be laid down in a programme with a view to minimising the shrinkage of the welds, just as is done for the shrinkage of concrete work.

D) *Metallographic analysis of the parent metal and weld metal.*

This is a matter of the first importance, for it is necessary to be quite certain as to the weldability of the parent metal.

E) *Fabrication of members.*

This must be done with special care so as to avoid excessive tolerances which might call for an excessive amount of weld metal, with harmful effects.

F) *Special precautions.*

In special cases a particular procedure, such as pre-heating before welding, may need to be laid down.

Working arrangements.

G) *Electrical apparatus.*

Since it is important to be able to ensure a uniform deposition of weld metal great attention should be paid to the electrical installations and these should be specially designed for welding work. The transformers and cable leads must be such that drop in voltage and amperage is limited to a reasonable amount. A sufficient number of electric measuring instruments should be provided and continuously observed.

H) *Choice of electrical characteristics.*

This choice is a matter of great complexity. The temperature of deposition should be kept down in order to reduce thermal strains, but at the same time this temperature must be high enough to ensure good penetration. For any given job that is to say for steels of known composition when using electrodes of suitable type, where the pieces to be joined are of given thicknesses — there are certain optimum electrical characteristics which should be adopted.

I) *Limit of maximum diameter for the electrodes to be used.*

In Belgium a large proportion of the accidents which have occurred have been attributable mainly to the desire of the workshops to lessen their labour costs by working with too large a diameter of electrode. It is essential that this diameter should be kept down, in the first place on account of the danger which attends too rapid cooling and secondly because of the danger of using too heavy a current and causing correspondingly high thermal stresses. The maximum diameter of electrode has been provisionally fixed by the Ponts et Chaussées Belges at 5 mm, except for the bottom layer where the limit is 4 mm.

J) *Precautions to be taken in winter work.*

In Belgium it is now forbidden to carry out welding at temperatures below 4° C.

K) As a means of deciding the best method to adopt it would obviously be an advantage if the order of magnitude of the thermal stresses could be related to the various methods of procedure available, and in Belgium a group of engineers has entrusted a government laboratory with the task of making a complete survey of this subject.

Procedure after Operations.

L) The handling of pieces while still hot from welding should be forbidden.

M) Arrangements should be made to ensure that welds are allowed to cool slowly.

N) It is to be hoped that the experiments now embarked upon in Belgium will lead to the development of special devices which will be both practical and economical for lessening thermal stresses after welding.

III b 6

Recorded Failures of Electrically Welded Wrought Iron and Mild Steel Bridges.

Versager bei elektrisch geschweißten Brücken aus Schmiedeeisen und Flußstahl.

Ruptures enregistrées sur des ponts en fer forgé et en acier doux soudés électriquement.

H. J. L. Bruff,

Bridge Engineer, North Eastern Area, London & North Eastern Railway. York.

In connection with welding work on existing bridges, I have searched for but failed to discover any paper describing failures of welding, and as failures have been experienced in the carrying out of bridge welding by my Chief, Mr. *John Miller*, Engineer of the North Eastern Area of the London and North Eastern Railway, England, I submitted my paper "Recorded Failures of Electrically Welded Wrought Iron and Mild Steel Bridges" to this meeting in the hope that not only failures experienced by others might be brought to the attention of the International Association of Bridge and Structural Engineers, but that these failures as well as those described by me might be considered and their true nature and portent be determined, and if considered of sufficient importance, that the correct procedure to be followed and the necessary precautions to be taken to avoid similar failures be agreed on and laid down.

Since submitting my paper, failures somewhat different from those described by me have been recorded, and I am therefore taking this opportunity, so generously extended to me, to describe these.

The failures occurred in the course of carrying out the repairs to an old Wrought Iron plate girder bridge in the City of Leeds, which, apart from having suffered very badly from corrosion needed to be strengthened, as it was considered of inadequate strength to carry modern traffic.

When constructed in 1867, the local authorities insisted that the bridge should be given an ornamental appearance, as it was situated close to the chief centre of worship of the City and spanned the main approach to it. The main girders, of box construction, were therefore encased with ornamental C. I. plates in the then prevailing Gothic style of architecture, while the underside, until recently, was similarly boxed in with ornamental Gothic panelling. As a consequence, large portions of the bridge had remained inaccessible for painting and inspection since it was constructed, and when recently the casing plates were removed the ravages from corrosion were found to be serious and extensive.

There were two alternatives:

- a) To renew the bridge, which would have been very expensive, as it was hemmed in on all sides with valuable business property, as a stoppage of traffic for even a short period was out of the question, it being one of the most important railway lines in the North of England.
- b) To repair and strengthen the old bridge by electric welding, which method was adopted.

The observed failures of the welding occurred in the cross girders, which were of box type construction. They were badly corroded and had also suffered distortion of the webs due to overloading. This was caused by the removal, at some time, of certain rivets and their substitution with bolts which had rusted

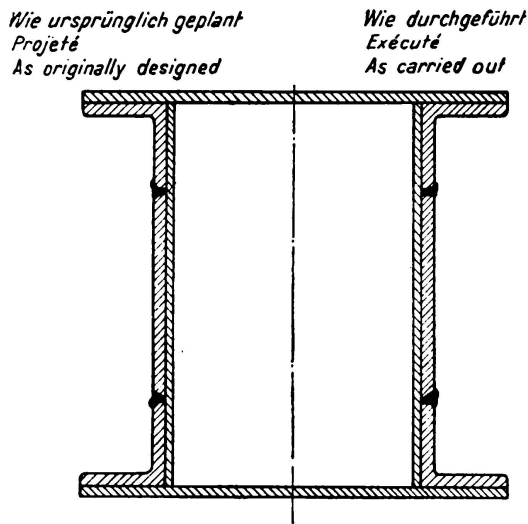

Fig. 1.

Section of Cross Girder.

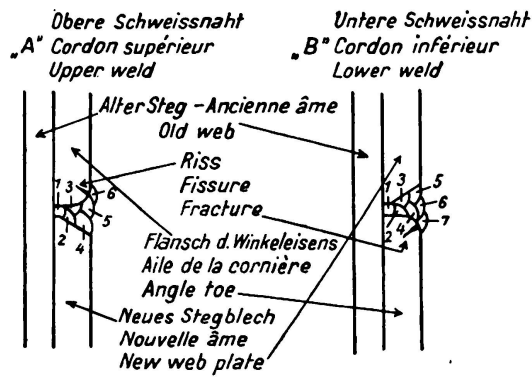

Fig. 2.

Details of Web Butt Welds as designed.

away. The work, therefore, became more extensive than anticipated, and of a very difficult nature.

The most difficult portion of the work was the welding in of new web plates, as these had to be fitted in between the vertical flanges of the cross girder angles, which necessitated using fairly large butt welds. The procedure of carrying out this work was to tack weld the new web plates to the angle toes and then to weld alternately the top and bottom butts in runs of six inches, the number of runs being in some cases as many as seven. The butts when prepared were of the usual form adopted by my Chief for welds of this kind and the welding was as indicated in Fig. 2, A and B.

It was found that when the final weld had been deposited, a fracture developed along the parallel to it, as shown on the photograph (Fig. 3). It was considered that the deposition of further welds (Fig. 2, A 6 and B 7) would not of necessity guarantee that these would reach sound metal at the root of the fractures.

After a number of experiments it was found that the method indicated in Fig. 4 was most satisfactory.

The lower or bottom weld was run first the full length of the web and then the upper or top weld. As will be noted, there was no chamfer in the case of the top weld, and in the case of the bottom weld, there was no face to the chamfer, which was run to a sharp edge. The sharp edged type of chamfer has

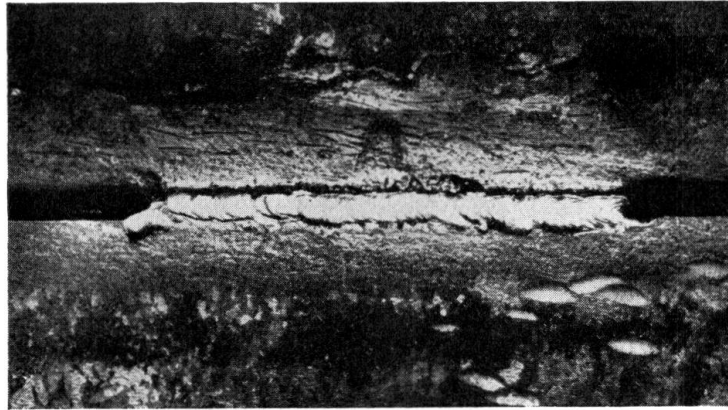

Fig. 3.

Fracture in angle parallel Weld.

since been adopted instead of the form shown in Fig. 2 above, as it secures better fusion at the junction of the plates.

The fractures seem to be caused by the contraction of the metal at right angles to the rolling direction extending as the welding proceeded. A piece of the

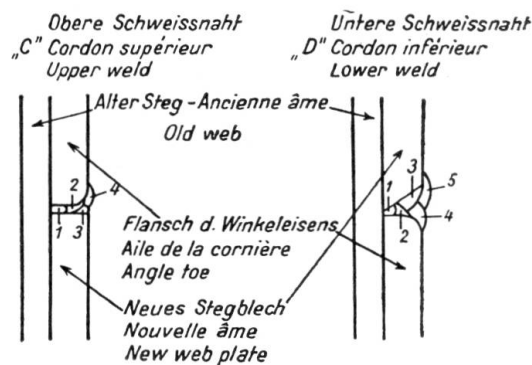

Fig. 4.

Web Butt Welds as carried out.

angle cut out disclosed a fibrous structure parallel with the length of the bar, such as wrought iron of good quality invariably shows.

The idea underlying the method finally adopted was to provide a coating weld (Fig. 4: C 2 and D 4) which would offer greater resistance to the contraction set up by the shrinkage of the welds (Fig. 4: C 3 and C 4 and D 5) than the W. I. of the angles. After adopting the method described, no fractures have taken place when the welds were made, nor have any fractures developed since.

III b 7

The Reduction of Thermal Stresses in Welded Steelwork.

Verminderung der Wärmespannungen in geschweißten Stahlbauten.

La réduction des contraintes thermiques dans les constructions métalliques soudées.

Dr. Ing. A. Dörnen,
Dortmund-Derne.

In welded steelwork thermal stresses are a combination of the rolling stresses which are present in the individual members as the result of rolling, and of the welding stresses which are caused by the welding operation. These two kinds of stress are superimposed on one another, and two problems consequently arise:

- 1) That of minimising thermal stresses in welded steelwork, and —
- 2) That of ascertaining whether the thermal stresses which are unavoidably present in welded steelwork impair its load carrying capacity.

Rolling stresses are the result of uneven cooling, and they occur even in the simplest shape of rolled section, which is the round bar. In such a bar the core is in tension and the outside is under a corresponding amount of compression, because after being rolled the bar cools from the outside inwards; hence the plastic core follows the earlier shrinking movement of the outside without any stresses arising therein, but when the outside has solidified it is not, in its turn, able to follow the subsequent shrinking of the warm and plastic core, and as a result it is placed in a state of elastic compression which is balanced by elastic tension in the core after the cooling process is completed. These conditions of stress may be demonstrated by means of an experiment as follows:

If a round rolled bar 80 mm in diameter by 1000 mm long is turned down to 30 mm diameter, thereby releasing the core which is in tension from the surrounding outside portion which hinders the contraction of the core, it will be found that the core shortens by about 0.15 mm. This would correspond to an average rolling stress of approximately 300 kg/cm² in the core.

Rolling stresses can be reduced by annealing, but not eliminated, because the same conditions remain after cooling as were present in the red hot bar during the rolling process. The slower, however, the hot bar is allowed to cool, the smaller will be the remaining stresses. The following experiment serves to show that a bar cannot be entirely freed from stress even by repeated annealing operations:

A round rolled bar of 70 mm diameter by 1000 mm in length was made red hot 63 times and on each occasion was allowed to cool slowly. In this way it became

about 26 mm shorter because, when the bar was heated, the outside (which as already explained is under a state of elastic compression) became hot and plastic before the core; the tensile stresses which were present in the core while still cold and elastic served to compress the already plastic outside portion, and in this way the bar was made shorter and correspondingly thicker. After this action had taken place the glowing bar was free from stress, but when it had cooled down as a whole the thermal stresses, as already explained, became the same in magnitude and distribution as after the original rolling. If the experiment were repeated often enough the bar would finally become a ball.

In less simple cross sectional shapes of rolled section the rolling stresses are generally higher than in the simple round bar. For instance, in the webs of I-beams NP 50 the compressive rolling stress has been found to be 170 kg/cm², and in the webs of broad flange beams 42¹/₂ cm deep compressions up to 1600 kg/cm² have been measured.¹ The large difference is accounted for by the differing proportions of the flange to the web. In the welding of steel structures it is advantageous to use the simplest possible cross sections with the smallest possible rolling stresses, and for this reason, for instance, slit I-beams are not suitable.

The *welding stresses* are superimposed on the rolling stresses in the process of welding; their magnitude and extent depends on the appliances used and on the sequence followed in the welding operation.^{2, 3} Under otherwise equal conditions, such stresses will increase with the size of the cross section of the seam, and the latter should, therefore, not be made larger than necessary. For the same reason X-seams are preferable to V-seams, for with the same angle of 90° and the same thickness of material a given load capacity can be carried by an X-seam of only half the cross section of a V-seam — involving, therefore, only half the welding work — and correspondingly smaller welding stresses will result. Apart from this the eccentric position of the V-seam causes the plates to be welded to be thrown out of position which can only in very rare cases be compensated by appropriate arrangement of the pieces to be welded, so that adjustments have to be made after the welding is completed, at great expense and to the detriment of the structure.

In seams of equal cross section the welding stresses are heavier when the welding is done with a thick electrode in a single layer than when it is carried out using thin electrodes depositing several layers. In structural steelwork no electrode larger than 7 mm diameter should be used, but on the other hand it is not advisable to go below 4 mm diameter because the heavy sections usual in this class of work cannot then be adequately fused to ensure perfect penetration.

The welding stresses can possibly be somewhat reduced by making use of intermittent welding, but the numerous beginnings of runs, with their attendant disadvantages, must then be taken into account. On the whole, therefore, it is better to carry out the welding in a single run, beginning at the middle of the work and proceeding simultaneously towards either end.

¹ Dörnen: Schrumpfspannungen an geschweißten Stahlbauten. Der Stahlbau 1933, No 3.

² Schroeder: Zustandsänderungen und Spannungen während der Schweißung des Stahlbaues für das Reiterstellwerk in Stendal. Der Bauingenieur 1932, Nos 19/20.

³ Krabbe: Entstehung, Wesen und Bedeutung der Wärmeschrumpfspannungen. Elektroschweißung 1933, No 5.

Bierett, in an article printed in *Stahlbau*, 1936, N^o 9,⁴ and also in his paper for the Congress, distinguishes between natural and secondary welding stresses, and further subdivides the latter into those which are the result of internal and those caused by external conditions. The natural welding stresses are on a par with rolling stresses and must be dealt with in the same way as the latter, being usually no greater in magnitude⁵ and, in *Bierett's* opinion, not dangerous. The secondary welding stresses due to internal causes are the result of building up the seam over its whole length and throughout its thickness in separate layers one over another, and to welding still going on while previous deposits are already cool. In the bottom layers of thick seams these stresses are especially critical and may easily give rise to cracks whereby the seam is rendered unsound at its core; they can, however, be reduced to insignificant amounts by careful hammering of the cold bottom layers and — as *Bierett* recommends — by suitable heat treatment, allowing the portion of the seam which has already been deposited to remain hot until the whole of the seam is completed, at any rate as regards the bottom layers. In the case of particularly important seams — as, for instance, the butt joints in tension flange plates — it is advisable to make the seam thicker than the flange plate itself, and to make the joint red hot for a distance of about one quarter of a metre on either side, while hammering the projecting portion of the seam down flush with the plate. In doing this, working at a blue heat should be avoided. In this way not only can all secondary welding stresses due to internal effects be eliminated, but in addition the grain structure of the weld seam is rendered more dense, and the contact between the weld metal and the parent metal is made more intimate at the delicate place of junction. It is thus possible to secure almost the same conditions of stress in the joints of flange plates, and also in those of web plates (and even in universal joints in plate web girdes) as if the plates had been rolled in single lengths. For this purpose good results have been obtained using gas burners which consist of long pipes having rows of burner holes suitably arranged over the work, the necessary gas being taken from the gas pipes in the shop. For use on site the fuel can, if necessary, be compressed gas, or liquefied gas taken from cylinders.

Welding stresses due to external conditions occur when the parts to be welded are unable to follow up the shrinkage of the seams. As regards most types of member now in use — such as solid webbed forms of plate girder, plated arches, plated frames and plate webbed beams reinforced with arches and Vierendeel girders — these stresses again can, to a considerable extent, be eliminated by taking suitable precautions. This will be illustrated in the *first* of the examples below.

The plate web girder, in its simplest form, best adapted to welding, consists of a web plate and two flange plates which extend over the whole length of the girder without any joints. In this form only the neck seams connecting the flanges to the web have to be run and the stiffeners welded into place. In the neck seams the secondary thermal stresses can, if it is considered necessary, be eliminated by heating every seam over the whole length at once to approximately

⁴ *Bierett*: Welche Wege weisen die Erkenntnisse über Schrumpfwirkungen den Arbeitsverfahren für die Herstellung von Stumpfnähten im großen Stahlbau? *Der Stahlbau* 1936, N^o 9.

⁵ *Dörnen*: Schrumpfungen an geschweißten Stahlbauten. *Der Stahlbau* 1933, N^o 3.

400—500° C. If care is taken that the flange plates are able to follow the transverse shrinkage of the neck seams without any resistance being offered, no secondary thermal stresses due to external stressing need arise. The stiffeners, as a rule, are best welded into place after the web plates and flange plates have been welded to one another, because after the neck seam are welded the web is at first mainly in compression, and by welding on the stiffeners parallel or at right angles to the axis of the girder such compression is diminished or is converted into tension, while the tension present in the flanges is likewise reduced. At those places where vertical stiffeners are to be welded on a gap of about 20 cm length of the neck seam should be left open on either side, this gap to be filled in after the stiffeners have been attached. This procedure serves the better to equalise the shrinkages in the web plate produced by the vertical stiffener seams.

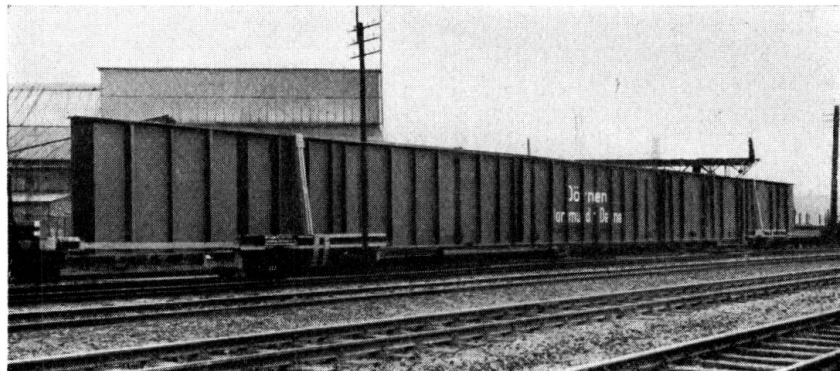

Fig. 1.

For the vertical seams 3 mm thickness is enough. This simple arrangement is limited to cases where the dimensions of the girder do not necessitate an excessive thickness or length of flanges, but too great thickness of undivided flange plate is not desirable, as it leads to difficulties in rolling. Using steel St. 37. 12 it is not advisable to exceed 60 (70) mm thickness. Where the thickness is considerable the flanges are preferably divided into several layers each of which is without joints if possible. In such a case the web plate should first of all be welded to the innermost flange plate the reason for this being that the tensile forces in the neck seams, shrunk longitudinally, are smaller for equal seam sections, if the parts to be welded are comparatively light and flexible. The stresses are further diminished by the use of fillet seams for attaching the additional flange plates. The stiffeners may most conveniently be attached after the web plate has been welded to the first, innermost, flange plate.

If the girders are too long to be treated in this way the web plate or the flange plates of both must be fabricated with joints. Generally speaking it is more often the web plate and less so the flange plates which are jointed. The web plate is first of all separately completed (using butt joints) and if necessary these seams are relieved of secondary thermal stresses caused by internal effects by heating and are examined by X-rays. Thermal stresses due to external effects may be avoided by clamping the pieces to one another while they are being welded, this work should not be left to the shrinking weld to do. The quality of any butt weld

depends primarily on ensuring perfect formation of the root layers, which must be free from even the finest cracks. Next, the edges of the web plate are cut to

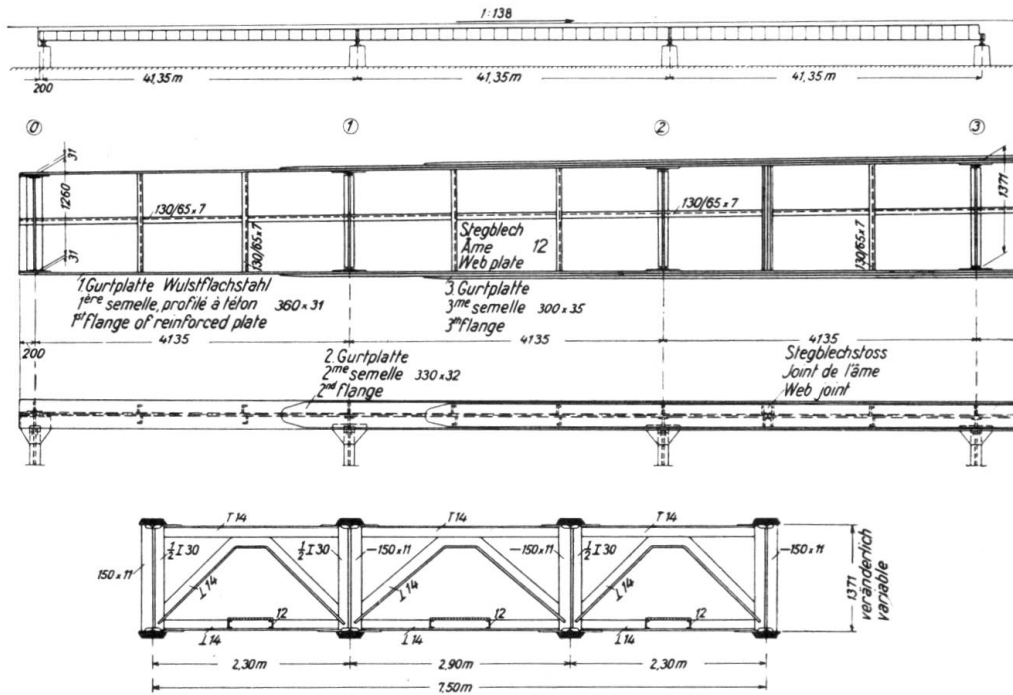

Fig. 2.

Welded river spans.

fit the camber of the girder, then preparations are made for welding on the flange plates. The stiffeners are welded into place after the web plate has been welded to

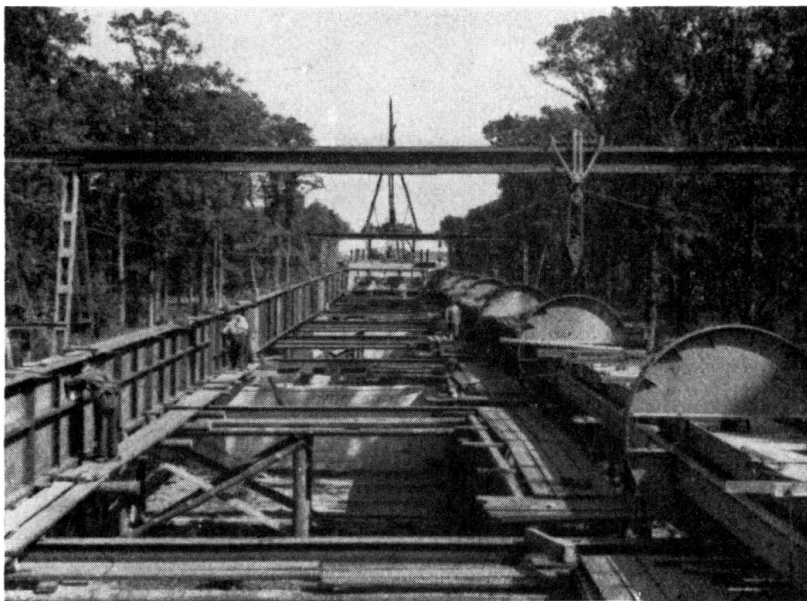

Fig. 3.

the innermost flange plates. Vertical stiffeners close to vertical butt joints in the web plate are to be avoided so that the latter may not receive too heavy tension.

If, further, the necessity for joints in the flange plates cannot be avoided, these are welded before making the connection to the web plate, the result then being as good as if there were no joints. In the case of the flange joints sec-



Fig. 4.

dary thermal stresses due to internal effects should be avoided by suitable heating. Secondary thermal stresses due to external effects do not arise. The joints in the flange plates should preferably be placed where the stresses are

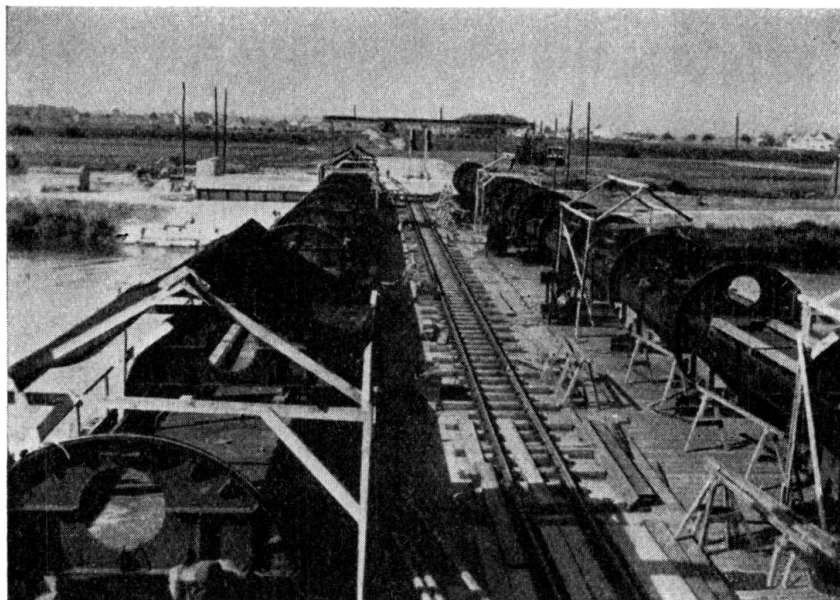

Fig. 5.

least; for instance, in the case of continuous girders they should be placed where the bending moment is at a minimum so that the material is under only a light

stress. It is desirable that the flange plates and web plates should not be jointed at the same cross section of the girder.

In this way it is possible to build up very large plate web girders, in very long lengths. Fig. 1 shows such a girder 63 m long by approximately 4 m deep, weighing about 105 tonnes, which was so constructed in the shops that the whole could be carried on special railway rolling stock belonging to the works, and was transported in this way from Dortmund-Derne to the site at the Rügendamm. For still greater dimensions, the web plate and the flange plate may be entirely welded together at the site, the same arrangements being provided as in the workshop. Of course all the seams should be arranged so that they can be readily

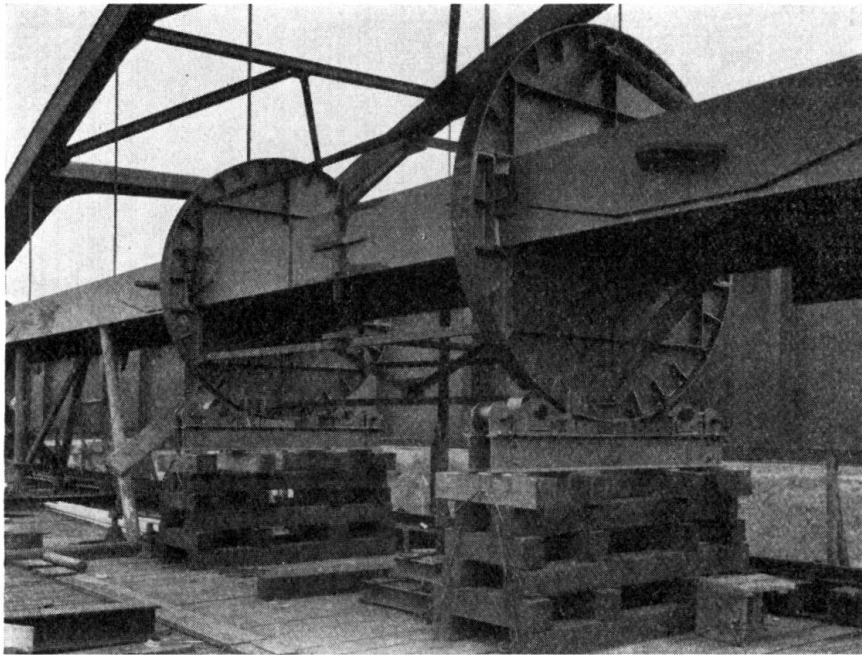

Fig. 6.

welded from above, the work being held in a suitable turning device and protected from the weather. As an example the construction of four plate web girders each 130 m long may be mentioned, these girders resting finally on four supports as shown in Figs. 2, 3 and 4, for the Elbe bridge at Dömitz, using St. 52. The girders were constructed exactly as described above and no difficulties arose, although this was the first occasion on which this method had been applied. In the same way the stiffening girders, approximately 95 m long, for a *Langer* girder bridge with reinforcing arch carrying the Reichsautobahn over the Lech near Augsburg were built (Figs. 5 and 6).

So far, it will be seen, the conditions for welding plate girders are particularly favourable, but they become more difficult when it is impossible to avoid the necessity for universal joints and when it becomes necessary to weld together finished sections of the girders. When this is the case it is impossible to avoid thermal stresses due to external effects, but by adopting a suitable sequence in the operations it is possible to keep the stresses within reasonable limits and to control them in such a way that, for instance, within the region of maximum

tensile stresses due to welding a compressive stress is pre-imposed, and vice-versa. An example of this is shown in Fig. 7 which represents the joint for a plate web girder for the bridge over the Strelasund in the Rügendamm crossing, formed of welded continuous girders resting on six supports and

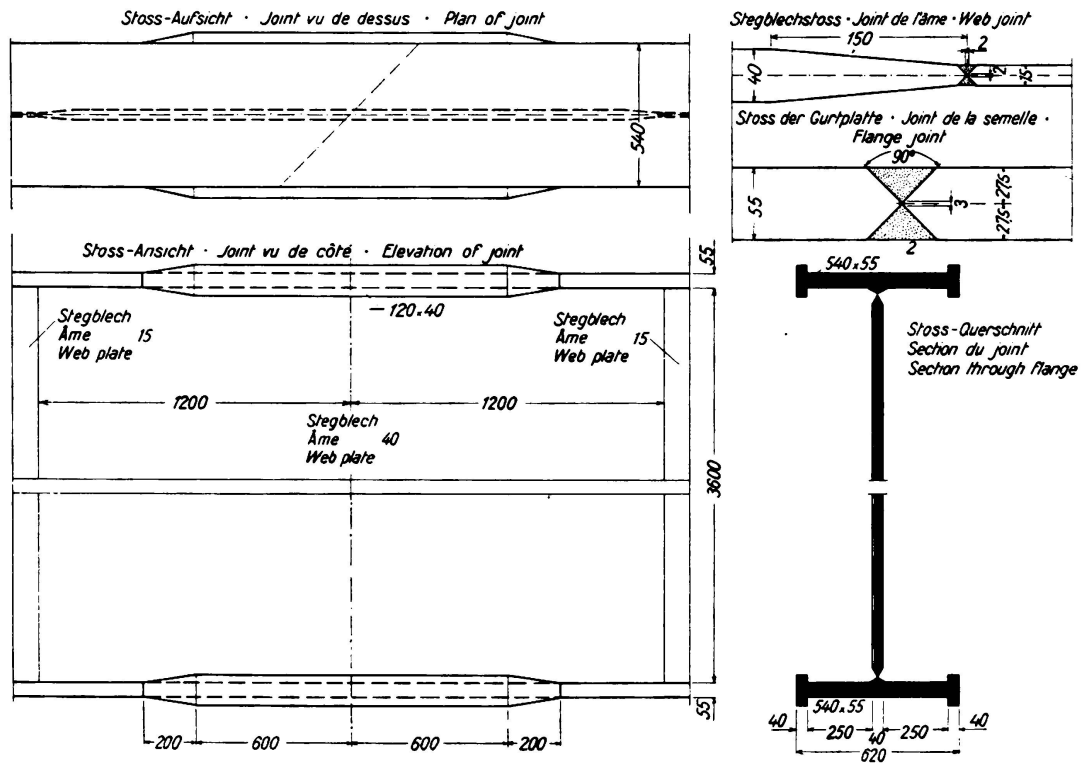

Fig. 7.

spanning over 5 openings of 54 m each. After accurate measurements carried out by the Staatliches Materialprüfungsamt in Dahlem a welding procedure was laid down which called for pre-stressing to approximately 300 kg compression in order to reduce the maximum tensile stresses due to dead and live load at the

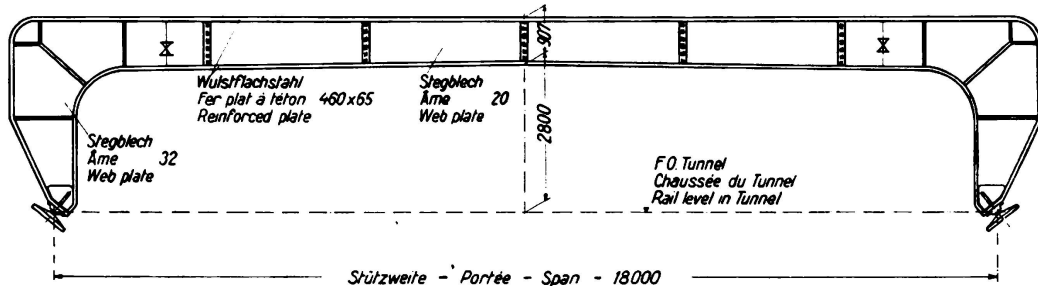

Fig. 8.

most heavily stressed portion of the tension flange. The reinforced web plate was required in the middle third of the girder, and had to be given a pre-stress of about 350 kg tension.

In plate webbed arches and frames, the conditions in regard to thermal stresses are hardly less favourable than in the case of plate webbed girders, provided that care can be taken to avoid stresses due to external effects. In the case of the

plate webbed frames shown in Fig. 8 (Duisburg) the three portions of the web plate were first welded to one another and were then connected to the jointless flanges bent to the required curvature.

Thermal stresses due to external stressing were avoided by adopting the procedure of welding from the middle of the span outwards towards both hinges, and also by the adoption of suitable arrangements for attaching the flange plates to the web plate.

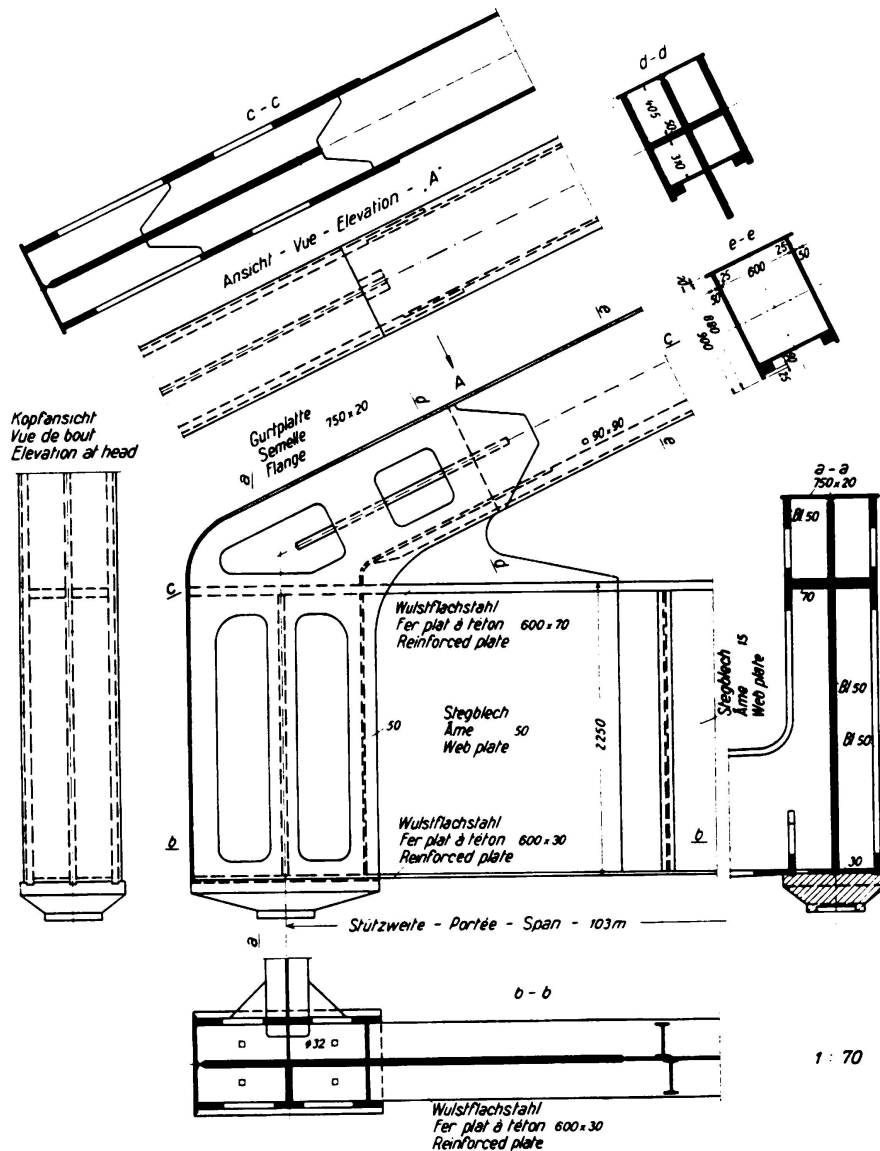

Fig. 9.

So far reference has been confined to structures which may be regarded as plane. The shrinkage stresses due to external effects are more difficult to cope with in three-dimensional structures, and in these special precautions may have to be adopted. Thus Fig. 9 shows the end of a welded Langer-girder of 104 m span, composed entirely of rolled sections welded together. The welding of this job, while not attended by any insuperable difficulties, was nevertheless not easy, and moreover a great deal of welding work was involved. The end piece was

and welding thereby saved. In the author's experience the most economical way to construct truss bridges is to form the individual members of the trusses and of the floor from rolled sections which are individually welded but to make the intersections and connections by riveting. In the case of the tension members the weakening caused by the presence of the rivet holes can be compensated by local reinforcements welded on. The author has been responsible for several structures on these lines which have been economically very successful; one of these is represented in Fig. 11.

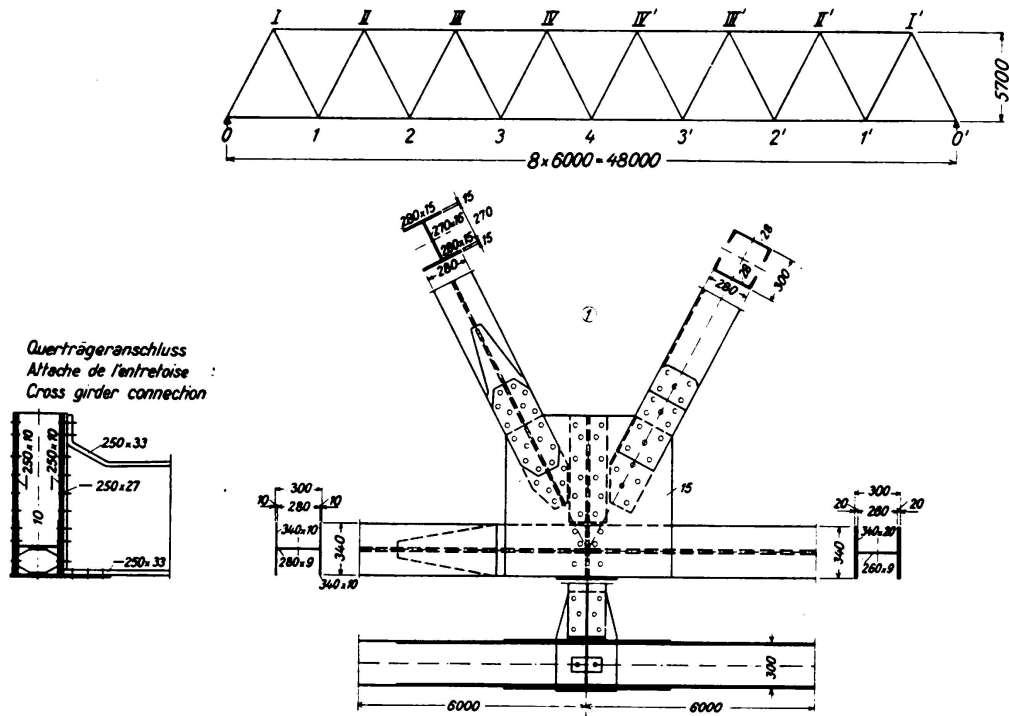

Fig. 11. Main girder. Intersection No. 1.

The *second* of the two problems is answered if the thermal stresses (using also normal sized welds) can be shown to be no greater than the rolling stresses in rolled joists, for the latter are shown by decades of experience not to be dangerous. In several forms of construction with specially thick seams, however, welding stresses have been measured which may sometimes exceed 2000 kg/cm², and stresses of this magnitude cannot *a priori* be assumed to be free from danger. On this matter *Dr. Schröder* of the Reichsbahn gave an explanation as early as 1931, and he also gave the reason why the welding stresses are so heavy. It has, however, been found by means of experiments on small test pieces that these welding stresses are not superimposed upon the stresses due to the loading, and therefore do not impair the carrying capacity of the member in question. No perfectly satisfactory explanation of this result has been advanced, but the fact remains. Since apprehension continued to be felt at the point, *Dr. Schaper* decided to carry out experiments on pieces of full size, and these are about to be published.⁶ One of these experiments may be described here: The two corners

⁶ Meanwhile published: *Schaper*: Die Schweißung in Ingenieurhochbau und Brückenbau. Elektroschweißung 1937, N^o 7.

of an all-welded frame forming part of the superstructure for a passenger subway in Duisburg (Fig. 8) were cut off and were subjected to loads in a 600 tonne press at Dahlem. The welding stresses represented in Fig. 12 were measured in these two pieces. The corner carried an experimental stress of over 2500 kg/cm² without showing visible damage. No heavier load was possible in this machine, but the corner piece is now to be tested in another. This test proves that welding stresses of over 2000 kg/cm² do not impair the carrying capacity of welded structures. The same result was found in other large scale experiments by Schaper.

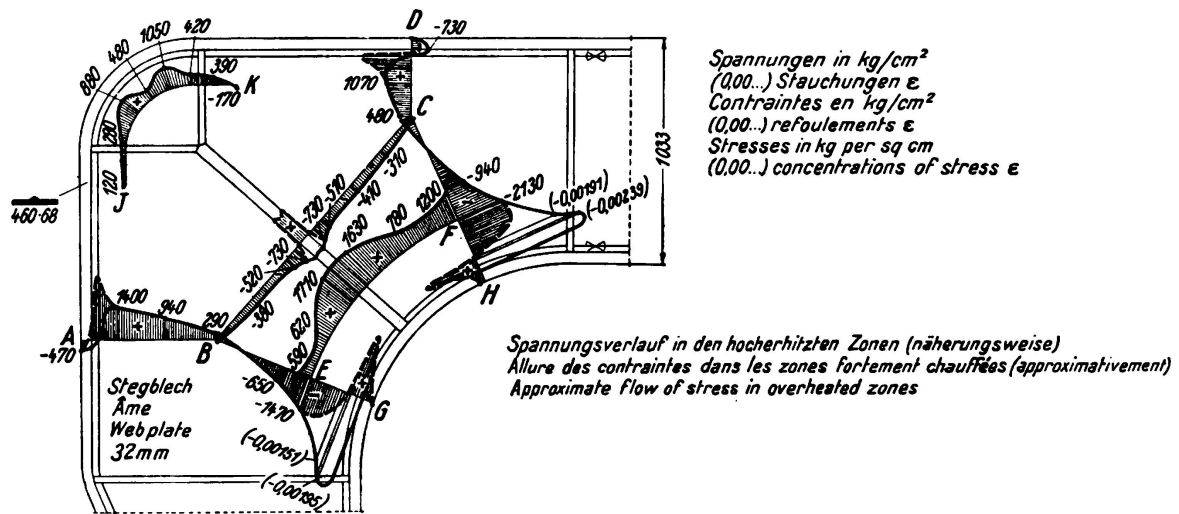

Fig. 12.

Measurement of welding stresses during construction.

Finally reference may be made to an article by *Körber* and *Mehovar*⁷ in which it is shown that the mechanical properties of rails fresh from the rolling mill are altered by storage alone. The elongation and the reduction of area before breakage (which are criteria and measurements for the soundness of the material) undergo considerable increase by longer storage. This effect may be more rapidly made and more marked by tempering and annealing, a fact which is attributed to the equalisation of stresses in the texture of the material. These conditions, which are true of rail steel, cannot of course be applied straight away to structural steels, but at the same time the behaviour of the latter cannot be altogether different and it may be inferred that in the case of weld seams, also, storage may be attended by some compensation of the internal stresses. Since, in the articles cited, a further improvement in the elongation test and in the reduction of area test was found to attend annealing which caused recrystallisation, the possibility suggests itself that important weld seams and the adjacent material might be treated in the same way. The author is of opinion that a further improvement in the quality of weld seams is conceivable from this point of view.

⁷ *Friedrich Körber und Johannes Mehovar: Beitrag zur Kenntnis der zeitlichen Änderungen der mechanischen Eigenschaften walzener Schienen insbesondere aus Thomas-Stahl. Mitteilungen aus dem Kaiser-Wilhelm-Institut für Eisenforschung zu Düsseldorf. Band XVII, Lieferung 7, Abhandlung 277.*

III b 8

Structural Welding in Practice.

Aus der Praxis der geschweißten Konstruktionen.

Sur la pratique des constructions soudées.

Dr. Ing. A. Fava,

Chef de Service aux Chemins de fer de l'Etat, Rome.

In Italy the use of welding has now become a matter of accepted practice in all branches of steel construction, but its application to bridges of large span still gives rise to notable difficulties. It is relatively easy, by adherence to the correct rules, to obtain welded joints which give the necessary strength even under the action of dynamic and repeated stresses, but difficulties arise as the result of the deformations which occur during the cooling of the seams in the construction of large bridges, and of the internal stresses which are thereby produced in the material. It has been found experimentally that these stresses may be very great.

If these deformations and the resulting internal stresses are to be avoided without the use of great thicknesses of material, it is necessary to adopt expedients and precautions which have the effect of considerably increasing the unit costs of welded work. Up to the present it has not been found, in Italy, that this increase in cost is compensated by a reduction in weight, so that under present conditions there is no economic advantage in using welding for large spans. The question is, however, receiving continued attention, in view of the emphasis that is being laid in Italy on the need to economise in steel, and it may be mentioned that preparatory work is now in hand among Italian steel makers for the production of special series of rolled sections which will facilitate welded work. These special sections will enable the deformations to be reduced, and it is anticipated that in this way an economic solution to the problem will be found.

On the State Railway system several bridges are in course of construction having plate-webbed main girders of spans up to 40 m which are completely welded. For still greater spans open-webbed bridges are preferred, wherein all the members including bracings are of welded construction, and only the site joints (including the connections between the web members and the booms) are rivetted.

Fig. 1 represents one of these bridges, and Fig. 2 shows one of its cross girders in course of being welded by means of an apparatus which enables it to be easily

and rapidly moved about, so that the sequence of weld seams can be arranged with a view to minimising the tendency to warping.

Despite every precaution, however, the contraction which occurred in the cross section of the weld seams while cooling resulted in the bottom of the girders

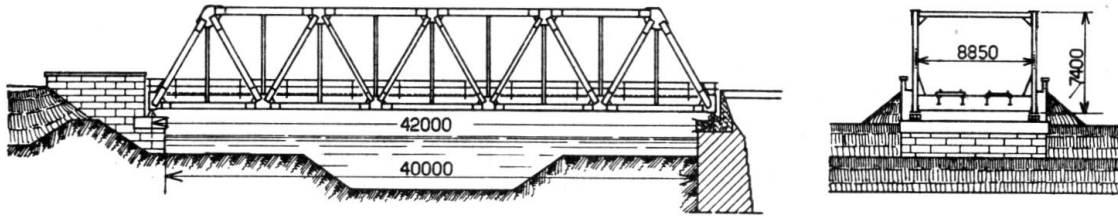

Fig. 1.

becoming bent, and at those points where (as for making the connections) it was essential that a perfectly flat undersurface should be obtained the only practicable remedy was found to be that of giving the plates to be used for the purpose a pre-imposed curvature in the opposite direction to that which would

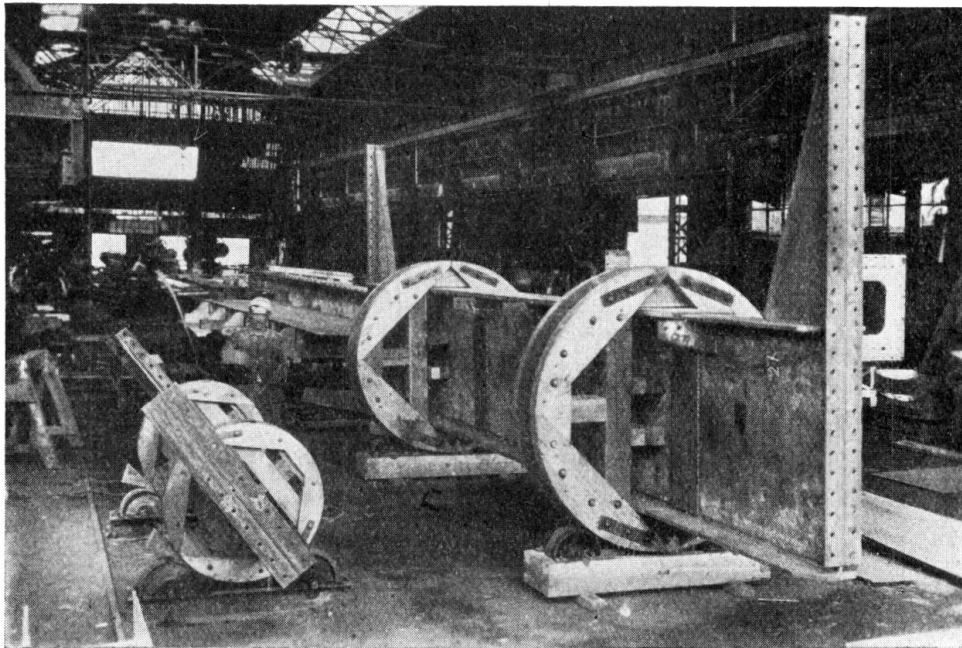

Fig. 2.

result from the cooling; an expedient which gives some idea of the costliness of the work.

Rather than enter into further details regarding these railway bridges, it is proposed to mention a few ordinary road bridges of completely welded construction, which, while of relatively limited size, may be of some interest as steps

towards more ambitious work. These bridges have openwebbed main girders, and welding is used even for the connections of the web members. It was found possible to choose the sections of the various members in relation to the



Fig. 3.

loads to be imposed upon them in such a way as to minimise the tendency to deformation.

Figs. 3 and 4 refer to a number of bridges over the Isorno torrent near Domodossola, wherein both the boom and the web members of the main girders are

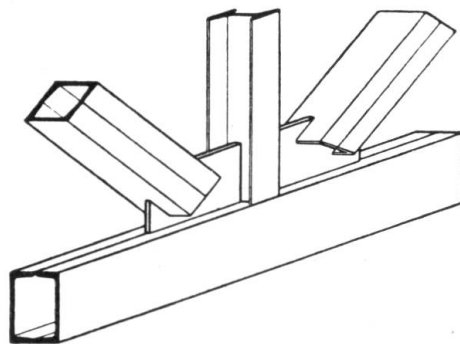

Fig. 4.

of tubular section built up by welding from two channel sections, slots being provided as in Fig. 4 for the insertion of connecting gussets.

Figs. 5 and 6 relate to two bridges of 25 m length over the Adige at Cengles. Here again the booms of the openwebbed main girders consist of double channel sections built up by welding. The diagonals consist of pairs of channel irons

connected by plates. The verticals are slotted and were formed by the use of the cutting flame to make suitable openings in I beams, separating the two parts so

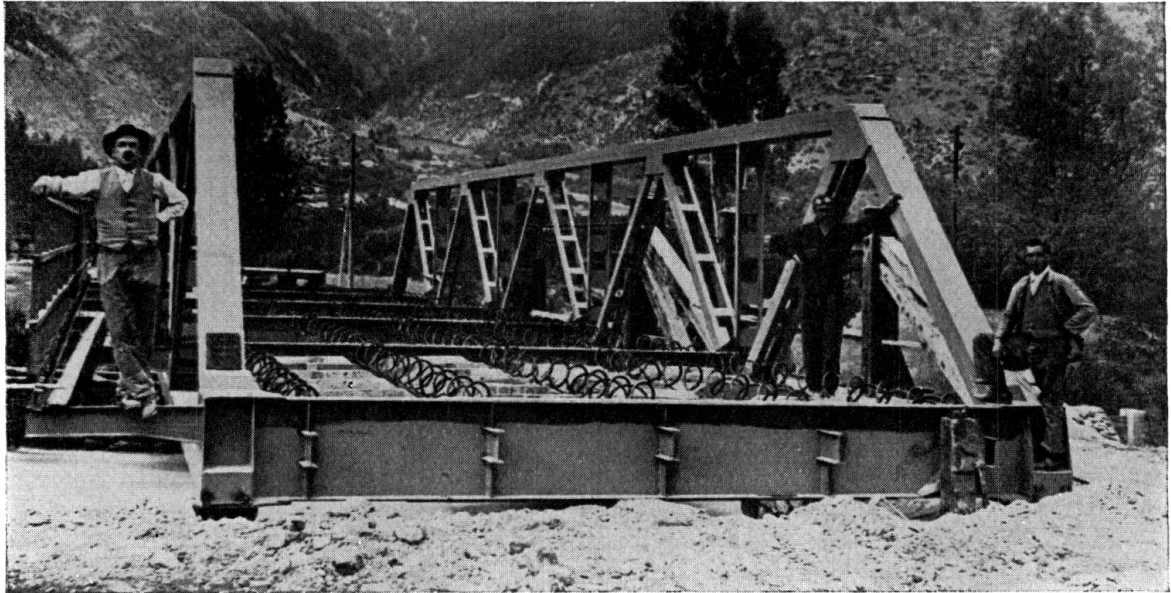

Fig. 5.

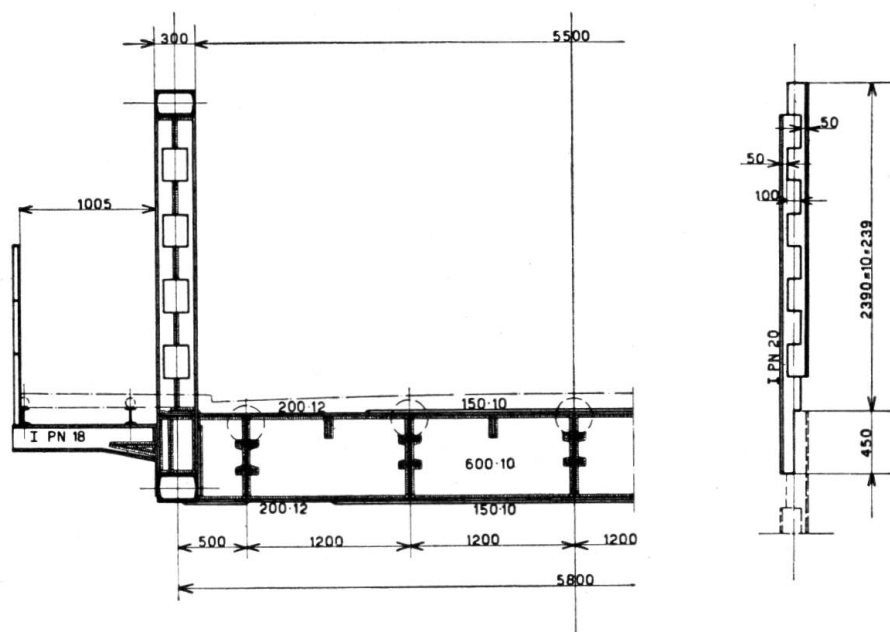

Fig. 6.

obtained and then welding the two projecting portions. The floor of the bridge consists of rolled beams of the well-known "Alpha" type, covered by a reinforced concrete slab.

Figs. 7 and 8 show a road bridge of 30 m span, in which the main girders are of solid-webbed construction and are reinforced above by a light arch in compression. The bridge gives a light and pleasing appearance and the whole of the booms are welded, including the end bearings.

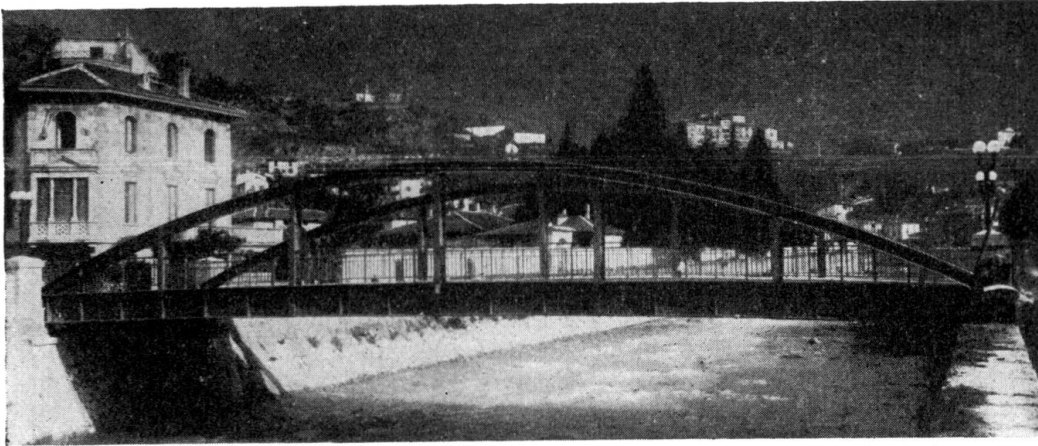

Fig. 7.

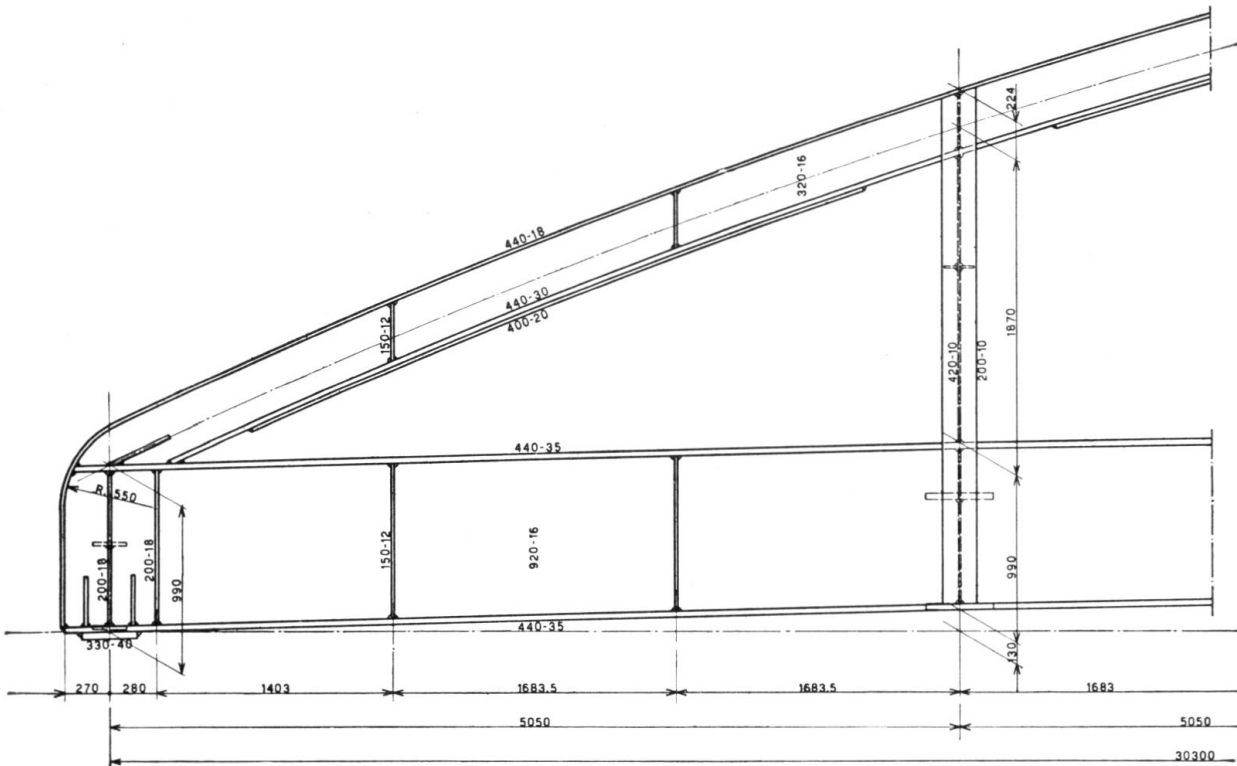

Fig. 8.

Leere Seite
Blank page
Page vide