

Zeitschrift: IABSE congress report = Rapport du congrès AIPC = IVBH
Kongressbericht

Band: 2 (1936)

Rubrik: VIIa. Application of steel in bridge and structural engineering

Nutzungsbedingungen

Die ETH-Bibliothek ist die Anbieterin der digitalisierten Zeitschriften. Sie besitzt keine Urheberrechte an den Zeitschriften und ist nicht verantwortlich für deren Inhalte. Die Rechte liegen in der Regel bei den Herausgebern beziehungsweise den externen Rechteinhabern. [Siehe Rechtliche Hinweise.](#)

Conditions d'utilisation

L'ETH Library est le fournisseur des revues numérisées. Elle ne détient aucun droit d'auteur sur les revues et n'est pas responsable de leur contenu. En règle générale, les droits sont détenus par les éditeurs ou les détenteurs de droits externes. [Voir Informations légales.](#)

Terms of use

The ETH Library is the provider of the digitised journals. It does not own any copyrights to the journals and is not responsible for their content. The rights usually lie with the publishers or the external rights holders. [See Legal notice.](#)

Download PDF: 13.03.2025

ETH-Bibliothek Zürich, E-Periodica, <https://www.e-periodica.ch>

VII a

Application of steel in bridge and structural engineering.

Anwendung des Stahles im Brückenbau und Hochbau.

Application de l'acier dans la construction des ponts et charpentes.

Leere Seite
Blank page
Page vide

VIIa

General Report.

Generalreferat.

Rapport Général.

Dr. Ing. K. Klöppel,

Leiter der technisch-wissenschaftlichen Abteilung des Deutschen Stahlbau-Verbandes, Berlin.

During recent years the steady pursuit of greater economy in construction has been combined with a desire to allow due weight to aesthetic feeling in the design of our bridges and in the development and application of steelwork generally. The artistic side of bridge design is now so much stressed that not infrequently a solution conspicuously good in this respect may be preferred even when it is not the cheapest that would satisfy the problem. To say this is not to imply that the aesthetic aspects of bridge building have been neglected in the past; for it is to those bridge builders who were at once engineers and architects, and who enjoyed the most unchallenged freedom of choice in their work, that we owe the existence of bridges of a aesthetic excellence beyond doubt and beyond the reach of change of fashion. We can only wonder at the boldness of the engineers who built long spans like the Britannia bridge and the Weichsel Bridge in Eastern Germany in the middle of the last century. Nor, in our present recognition of the primacy of the artistic side of bridge design, must we underrate the achievements of those engineers who, swept along by the rising flood of statical development which marked the years before and around 1900, envisaged their main objectives as mastery over statically difficult systems and in the choice of those structural forms which called for the smallest quantities of materials. The difficulties of that period — now almost at its end — were inherent in the designers' preoccupation with statical science, and they led, inevitably while they lasted, to a divergence between the engineer and the architect, the origin of which is now too readily forgotten.

This consideration is relevant when considering many of the old lattice bridges (such as the classical cantilever construction by Gerber over the Main at Hassfurt) which, though their "mathematical" form has become out of date, still stand as valuable and noteworthy monuments in the history of great bridge construction. From this intermediate phase of vigorous statical development we have now won through to a fortunate position in which we are enabled by the high standards attained in metallurgy, rolling practice, steel erection and statical procedure to subordinate the purely technical problems of bridge engineering to such refinements as (for instance) the choice of uniform and effective spacings for the stiffeners on the outside faces of plated girders, providing any additional

necessary vertical stiffeners on the inner face together with those horizontal stiffeners which may be particularly effective under conditions of heavy bending stresses.

Once again the eye is ready to recognise the beauty of clear-cut forms, and hence the reviving trend of co-operation between the engineer and the architect. But such co-operation is no longer understood to imply merely the addition of architectural trimmings; the architect now lends his aid in the actual detailing of steel bridges (as for instance in so arranging cantilever footways that they appear as a lateral closure of the bridge). In this it is right to acknowledge an important step — perhaps even a decisive step — forward in much debated ground; a step which marks the final escape of steelwork from that past period in which the architect looked upon steel as a medium foreign to his art, wherein he would build only with reluctance, and wherein his early efforts were often unpropitious. It was, however, a condition of this recent advance that the

architect should consent to some initiation into the fundamental statical and constructional problems of the engineer.

The aesthetic value of a bridge is conditioned — apart from subjective aspects — by the primary laws of design in nature — namely, eurhythmy and symmetry. The fulfilment of these laws, which will give recognition to builders for all times, lies in the employment of the simplest forms of construction. In this matter beauty and suitability are one; always provided that suitability is understood as meaning not merely the solution of the problem with the least possible use of material but its solution against a background of general understanding of the way in which a structure operates — an understanding which is, in fact, much more wide-

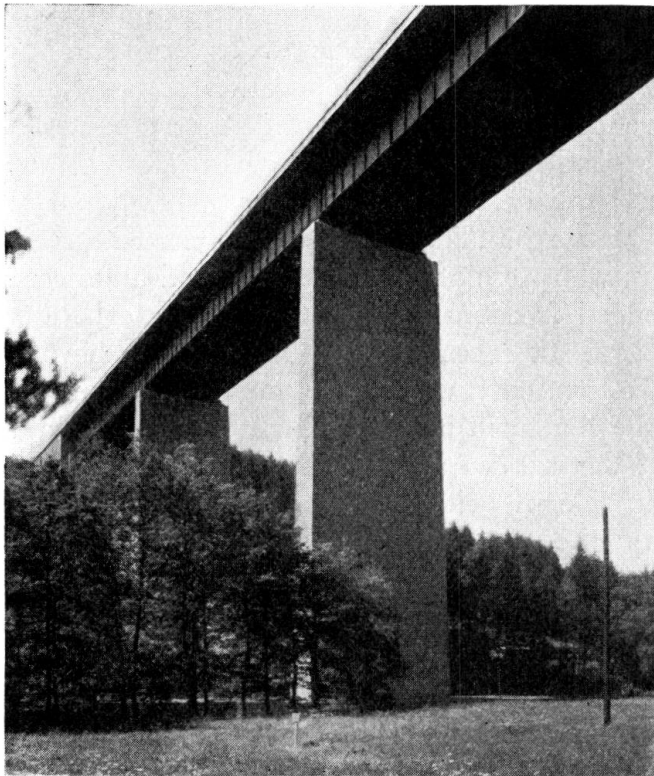

Fig. 1.

Reichsautobahn bridge at Siebenlehn.

spread than the engineer is disposed to admit. It is logical enough, therefore, that while the predominant type of bridge on the Reichsautobahnen is one of extreme simplicity advantage is being taken of the present development of technique to utilise economical forms of design of the beam type with the roadway above the girder, even in spans where arch bridges or compound forms of girder would previously have been preferred. In Germany there exist some masterly examples of this type of bridge, as for instance the Mangfall bridge at Darching (see Fig. 10, page 1348 in the Preliminary Publication). Later, in constructing

the viaduct near Siebenlehn (Fig. 1) the slender concrete piers were encased in natural stone, their vigorous pattern and varied tint being in pleasing contrast to the restful flatness of the rigid line of the steel superstructure. Another new development in the arrangement of steel bridge supports in the form of plate webbed portal frames (see Fig. 17, page 1355 in the Preliminary Publication). These supports give a paramount impression of boldness and slenderness which particularly suits the woodland setting of the bridge, and at the same time they serve to express some sense of the ease with which the interplay of forces is regulated and the great reserve of strength inherent in the steelwork.

Where it is possible through organic design of a deck girder bridge so to increase the constructional depth of the main girder that a trussed lattice construction becomes possible, and where this solution is not ruled out by the ver-

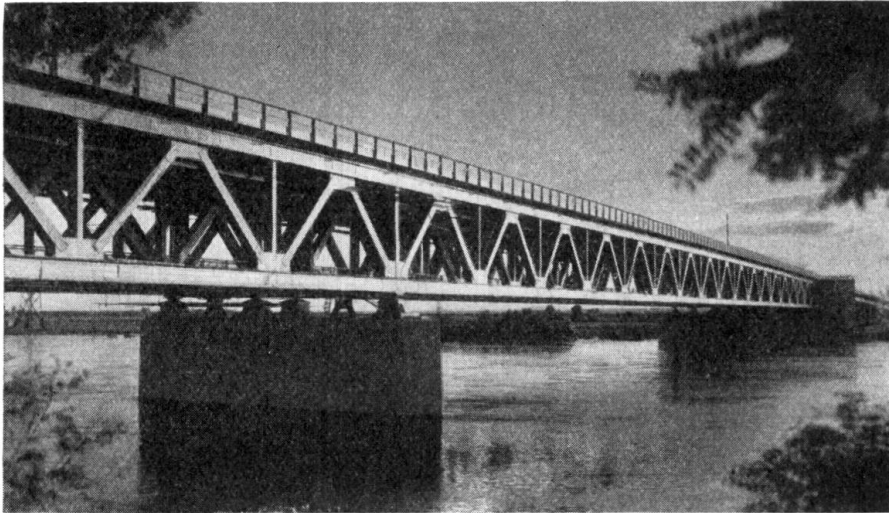

Fig. 2.

Reichsautobahn bridge at Hohenwarte.

tical and horizontal dimensions of the whole, the use of a truss should be contemplated not merely with a view to economy in material but also on account of its aesthetic effect which is in no way inferior to that of a plate webbed deck girder (see Fig. 2). It is generally and wrongly assumed that architects are flatly opposed to the use of trusses, whereas the fact is that they appreciate the varied expressiveness of this type of design and exult in the ornamental way that the interplay of forces is mastered therein. It is in this very choice of harmonious arrangement in the design of a truss — a choice always to be made with due regard to the scale dictated by the surroundings a matter too often neglected in the past — that co-operation between the architect and the engineer may hope to achieve its happiest results. In a suitable situation there should be no hesitation even in reverting to the use of fine meshed lattice work, for the well known objections to this form of construction no longer hold good, and it is one which can be made to harmonise excellently with a beautiful wooded landscape. The truss is the original form of steel bridge construction and the one which best lends itself to calculation, and there could be no justification for engineers ceasing to

develop this form of design. For long spans, in cases where the main girder must necessarily be placed above the roadway and where a trussed form of girder is, therefore, essential, its design has long been brought to a masterly degree of perfection (see Fig. 22, page 1358 of the Preliminary Publication).

Among the other basic types of steel superstructure the open-webbed arch with a suspended roadway is one which, during the last decade, has been used with advantage over very large spans of the order of 500 m, as for instance in the case of the Sydney Harbour Bridge. Here, just as was once the case in contemplating bridges of 100 m span, the impression of boldness tends to make one overlook the successful aesthetic effect. It is true that with spans of about 300 m slender plate-webbed arches also produce a very satisfactory aesthetic effect. In cases where the constructional depth is very small and the possibility of placing

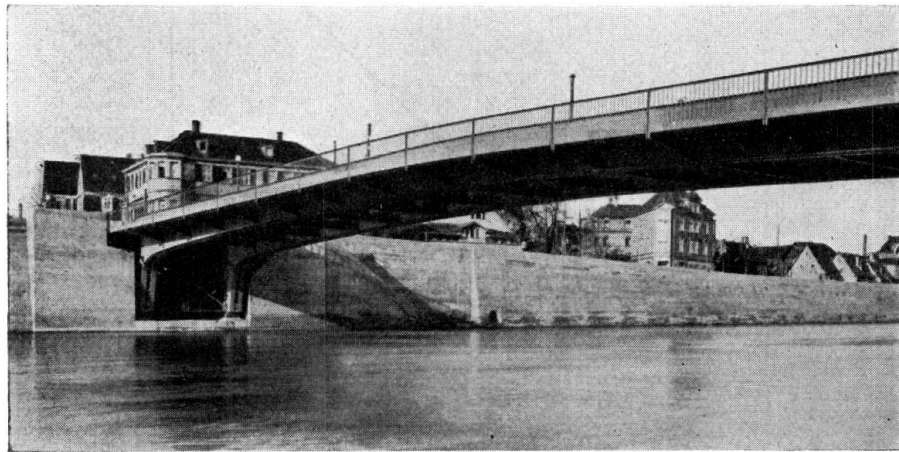

Fig. 3.

Wilhelm Bridge over the Neckar at Cannstatt.

the main girders above the roadway is limited by considerations of visibility, so that beam bridges with more than two main girders are ruled out, the true arch with a suspended roadway should again find scope for adoption over spans of less than 100 m. A recent development in this field has been the *Langer girder* (a particular type of bow-string girder, or beam reinforced with arch), presumably the result of difficulties in foundations.

The Swedish Mälarsee bridge, partly of welded construction, will be well remembered mainly on account of the instructive international competition of which it formed the object. In this design steel bridge engineers were offered the attractive (but unfortunately rare) problem of bridging across a wide sheet of water by means of an arch with an overhead roadway (see Fig. 1, page 1327 in the Preliminary Publication). Many of the details, also, are pleasingly successful (see Fig. 4, page 1329 of the Preliminary Publication) including the tubular supports, for which the use of welding proved particularly well suited. Welding may, indeed, be the means of reintroducing the use of tubes in bridge work to an important extent.

For small spans where the maximum possible rectangular opening is desired, as for instance over navigable waterways, a recent development has been the *rigid*

frame (see Fig. 3) in place of the arch, and there are many difficult problems from the points of view of construction, traffic or hydraulics to which no other satisfactory solution could be found than this space-saving type of steel bridge.

Finally, a brief reference must be made to *suspension bridges*. In America bridging problems reach an extreme which nothing but the suspension bridge is capable of solving, and it is there that the engineering world is now being staggered by the construction of the largest bridge in the world, namely the cable suspension bridge over San Francisco Bay with the prodigious span of 1,280 m (see Fig. 4).

The attraction of suspension bridges, both to the general public and more particularly to structural designers, is justification enough for the endeavours



Fig. 4.

Golden Gate Bridge.

that have been made in recent years to reduce the cost of such construction so that it shall be suitable even for the smaller spans encountered on the European continent and be competitive with other types. By improving, amplifying and simplifying the application of the "deflection theory"¹ — a method of design which takes account of the fact that elastic deformations relieve the loading of the stiffening girder and lessen its deflection — notable savings have been realised even in the case of suspension bridges of 200 m span with ground anchorage (see the original design for the Reich bridge at Vienna in Fig. 2, page 1278 of the Preliminary Publication). This form of calculation is true to the facts; in the case of pure arch bridges of long span it implies indeed an increased consumption of material (though the increase is small compared with suspension bridges), but when the span exceeds about 350 m it implies a reduction in the moments of the stiffening girder by more than 30%, and a reduction in the deflection by as much as 50% by comparison with the approximate method of calculation. If account is taken also of the economies that can be realised through using lighter roadway construction (reduction in the ratio of

¹ H. Bleich: Berechnung verankerter Hängebrücken (Springer, 1935). — F. Stüssi: Publications. I.A.B.S.E., Vol. 4, 1936. — W. Blick: V.D.I.-Zeitschrift, 1933, Vol. 77, No 34, p. 921.

live to dead load) there is ground for expecting a more frequent adoption of small suspension bridges, and the likelihood of this would be increased if it were possible to reduce the proportion of cost incurred in the cable.

This point may serve as a transition to considering questions of economics and development in steel construction; with special reference to the use of *high tensile steel* (a material to which many beautiful girder bridges owe their slender appearance) as well as the development of *welding* and the resulting use of *light construction*.

Recent fatigue tests² indicate that results obtained in usual static tests provide no reliable criterion for the fatigue resistance of various kinds of steel and

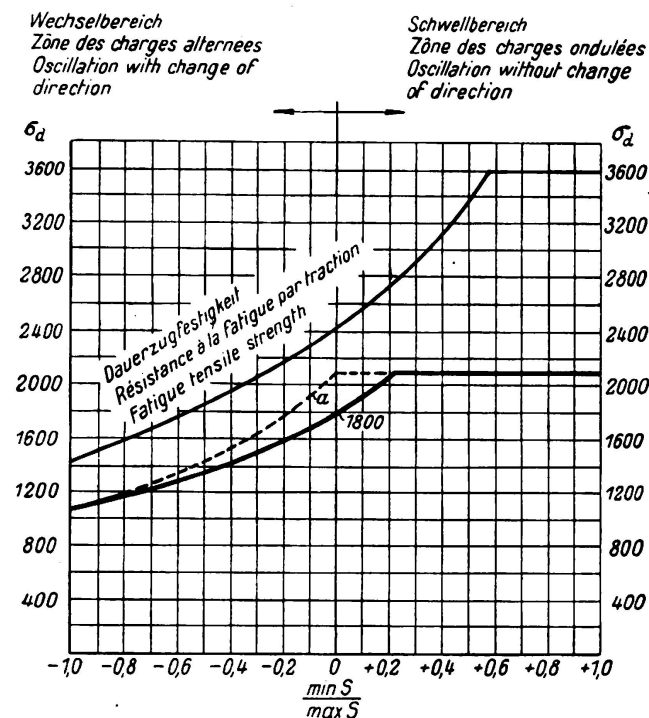

Fig. 5.

structural members. Under repeated, non-alternating stress, the amplitude of stresses in St. 52 is not much greater than in St. 37, while on the other hand the suitability of St. 52 for fatigue stresses is indicated even in cases where the initial stress exceeds the yield point of St. 37. Hence in the German regulations for railway bridges the use of St. 52 is contemplated mainly for members in which the initial stress is considerable (as for instance on account of dead load), which is the usage suggested by the shape of the curve correlating permissible stresses with the ratio of maximum to minimum stress (see Fig. 5). This is the reason why originally St. 52 was developed for very large bridges, for in these the conditions of stress are such as to render an increase in the permissible stress of St. 52

subject to the same considerations as those which entail a reduction in that quantity, in railways bridges, within the range of alternating stress and of the lower part of the range of pulsating stress. By the same reasoning there would appear to be scope for its use in road bridges and in building frames.

The applicability of results obtained on small specimens in a pulsator testing machine to the structural arrangement and conditions of stress in an actual bridge is problematical. Even though we know that the frequency of loading, and perhaps also the length of the intervals between traffic, are of no importance

² Klöppel: Gemeinschaftsversuche zur Bestimmung der Schwellzugfestigkeit voller, gelochter und genieteteter Stäbe aus St. 37 und St. 52. Tests to determine the tensile surge load strength (tensile fatigue strength) of solid, perforated and riveted bars of steel 37 and steel 52. Stahlbau 1936, N° 13/14, p. 97. And other references.

within the range which concerns us, many questions nevertheless remain unanswered. Lack of space prevents going closer into these here, though they are questions which must exert a decisive influence over the further development of the regulations. It will merely be stated that experience shows the dimensions prescribed by the regulations to be well on the safe side as judged by the results of fatigue tests carried out to date.

The concepts hitherto recognised such as yield point, ultimate strength, elongation at fracture, and reduction in cross section, are inadequate to explain the differing behaviour of the available steels under fatigue stresses, or many other observations which affect the suitability of designs — for instance, the circumstance that the effects of concentrations of stress increase with the size of the specimen, even though geometrical similarity and the same flow of forces is preserved. These are questions relating to the fundamentals of steel construction which can be cleared up only by reference to the *mechanics of materials*, and their use as criteria for the safety of a structure makes it necessary that they should be understood both in the sense of the mathematical theory of elasticity, and in that of general statical, constructional and practical application to the purpose in view. It follows that the mechanics of materials are an indispensable study for the steelwork engineer. He alone is in a position to determine which of the results will enable the known lacunae in the principles of steelwork construction to be filled. He must become familiar with how the mechanics of materials depend on physical data, while recognising that resistance is limited by susceptibility to corrosion and flow and is effected by concentrations of stress due to the presence of notches. In order to keep step with improvements in our methods of calculation it is necessary that our knowledge of the actual resistance of materials should be increased, and from this point of view research on the phenomena of plasticity acquires an additional though indirect importance beyond that appertaining to it in Question I of this Congress.

The welcome saving in weight represents no more than the first of the possibilities of increased economy in steel construction that can be realised through the adoption of *welding*. In this matter we are at the start of a development which is destined to be revolutionary in so far as riveted connections are replaced by weld seams, for welding, where advantageous, will direct the trend of steel construction towards monolithic forms of design which are of the very essence of light construction. The road leading to this goal is doubtless a difficult one, but the extraordinarily rapid development which has already taken place offers encouragement to follow it: a development illustrated in the application of completely welded sitejoints in plate-webbed railway bridges (as in the Rügendamm bridge) and of butt joints in main girders of large bridges on the Reichsautobahnen (as, for instance, at Rüdersdorf). The increasing reliability of butt welds gives grounds for supposing that butt-welded tensile and bending members may be subjected to higher specific fatigue stresses than riveted members, because the permissible stress thus escapes the considerable notch effect due to the rivet holes, well made butt welds with smooth surfaces over the seam being practically free from this notch effect. This requirement is satisfied in rolled beams only when they are made free from holes at heavily stressed parts.

In nearly all fields of application of metals constructional development is tending in the direction of *light construction*, an idea which has become a stimulus for new and revolutionary endeavours. On no account should this be understood as a mere makeshift in construction. It should rather be regarded as a higher stage in the utilisation of material, attained through careful structural arrangement taking due account of the inherent properties of the material, which renders the structure lighter and, at the same time, more resistant and stiffer than existing forms of design intended for the same purpose. Thus a reduction in the amount of material is made the means of improvement in quality. In reviewing the application of steel this fact must not be overlooked, particularly since development of certain elements of steel work is proceeding in the direction of light construction. Such elements will be primarily steel plates, flats, tubes and weld seams. In so far as it is not possible to publish tables of carrying capacity based on experiments, the calculation of increased capacity conferred by the monolithic character and three-dimensional action of these structures must be effected by simplifying the more difficult methods of calculation and permitting approximate methods of design to be used under the regulations. The successes attained in aircraft construction as, for instance, with torsion-proof rigid box shaped girders and posts or load carrying partitions from corrugated sheets, encourages the idea that in steelwork, also, a more economical type of construction may be realisable which shall be no less resistant than the present form. To set limits to the course which these developments are likely to take in the long run, on the basis of experience now available, must be abortive, for the economical application of light construction entails far reaching alterations in method of fabrication. Even to-day large edge bevelling machines are making their appearance in steel fabricating shops, and the adoption of cold pressed sheets (a trend which may greatly reduce the importance of rolled sections) is drawing attention to steels with increased ageing resistance. Thin rust-proof steel sheets, also, are attracting more and more attention. The stimulus towards overcoming the difficulties of the transition stage may be found in the certainty that light construction is destined to open out new fields of work.

In road bridge construction a conspicuous feature is the development of *light weight decking*, the most notable line of endeavour in this direction being the use of a fine mesh grillage which behaves statically as if it were a slab, and which has been rendered possible through the introduction of welding. It is true that in the suspended plates (trough plates) we already possess a form of supporting member which makes the use of plates possible in steel construction. But these are exposed to certain disadvantages which form an obstacle to reducing the weight of the roadway, namely the considerable weight of the concrete filling and also, the risk of corrosion which arises if trough plates are used over larger areas than has hitherto been the practice. Attempts are being made considerably to increase the area of trough plates with a view to economising in the number of girders of the deck construction, and, although it is not found that this increase gives rise to difficulties from the point of view of strength, there is no general regulation governing calculation of these plates. There is a risk, moreover, that under unfavourable conditions of loading (especially where the

trough plate with its relative lack of stiffness is used) the concrete may separate from the plate and allow water to enter. This matter will be mentioned again later.

With a view to reducing the dead load of the concrete filling in the suspended plate the expedient suggests itself of adopting a floor construction of flat sheets which are made to function as membranes, as has already often been done in movable bridges. These call for a very close spacing of the longitudinal joists. Another solution to the problem is offered by the use of welded grid plates often known as "cellular steel floors" (Fig. 6); the strength and stiffness, as deter-

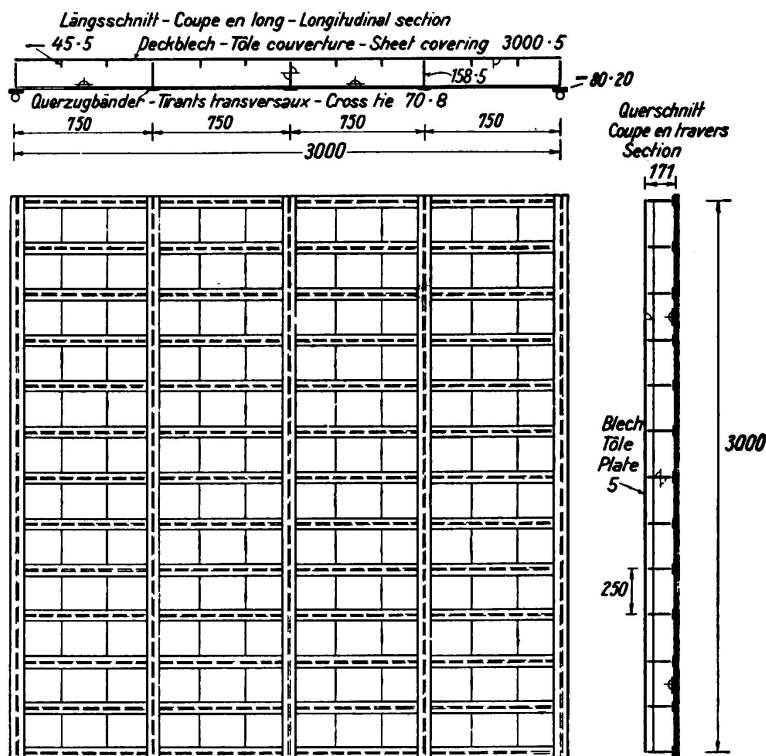

Fig. 6.

Tests on bridge floor members.

mined on specimens similar to those illustrated, are excellent, but the cost unfortunately is very high, as may be appreciated from the larger number of welded connections. Decking of this type has already been used with economy for field track crossings over the Reichsautobahnen. The limited amount of constructional depth required for the light-weight decking also enables economies to be realised in access ramps and other ancillary works, and in the case of small crossing bridges this may turn the balance of economy in favour of steel as against other methods of construction. The form of specimen shown in Fig. 6 (designed for a load of 110 kg/m²) lends itself to a simple method of calculation applicable to these members which depends, in the first place, on an understanding of the load distributing action of the flat member in relation to its fixation around the edges and to the constructional details. In this way it is possible to arrive at a simple, realistic and economical method of calculation, similar to that employed for reinforced concrete slabs reinforced in two directions, and to incorporate this

in the regulations. The first of the relevant experiments at Stuttgart arouse the hope that justification may be found for adopting the approximate formulae for slabs stiffened against torsion which is laid down in the German Reinforced Concrete Regulations, seeing that in these steel members the necessary stiffness is easily

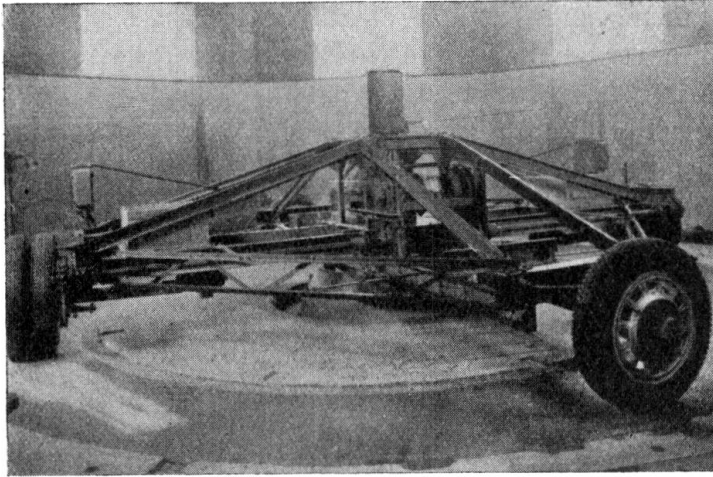

Fig. 7.

Rotary apparatus for testing plated steel floor.

attainable by means of suitable connections and flat bracing bars welded to the corners of the plate. It is obvious that these members represent an important new type of load bearing element in steel construction, which is designed to be widely employed especially in building work.

Since the pavement, the sand and the reinforced concrete protective and insulating layers weigh something like 450 kg/m^2 , which is about one half of the

total weight of a reinforced concrete slab floor, investigations were embarked upon to ascertain whether requirements might be met by covering the flat sheet

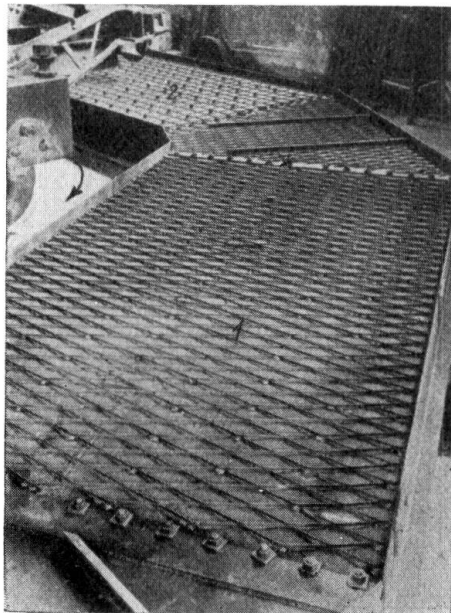

Fig. 8.

Expanded metal welded onto steel plates.

merely with an intermediate layer 4 cm thick of asphalt overlaid by a wearing course 3 cm thick of hard asphalt containing basalt chippings, stone dust and quartz sand as fillers, the tests being carried out on a circular road testing machine (Fig. 7) at Stuttgart. The flat plates were given a varying degree of stiffness from one section to another so that under the same load the deflections varied from 0.11 to 0.6 mm. After a test period which would correspond to four years of intense road traffic it was found that no separation had occurred between the covering material and the plate where these two were connected by expanded metal (Fig. 8), neither was there any sign of corrugation even for the softer plate. Powerful weathering effects were imitated in the tests and these disclosed the remarkably high resistance of the covering. In this way it is possible to construct light-weight decking with a depth of 80 mm weighing

280 kg/m^2 not including the longitudinal girders (Fig. 9). It is obvious, of course, that adequate stiffness and watertightness must also be ensured.

A number of other interesting ideas for light weight deck construction are now

being tried out. In America steel grillages of the open type have been used as roadway deckings, and light non-ferrous metals are also being tried, but the question arises whether these will possess the necessary fatigue resistance.

When it is remembered that the weight of the decking, including the longitudinal girders, may vary between 1,050 and 300 kg/m², the necessity for

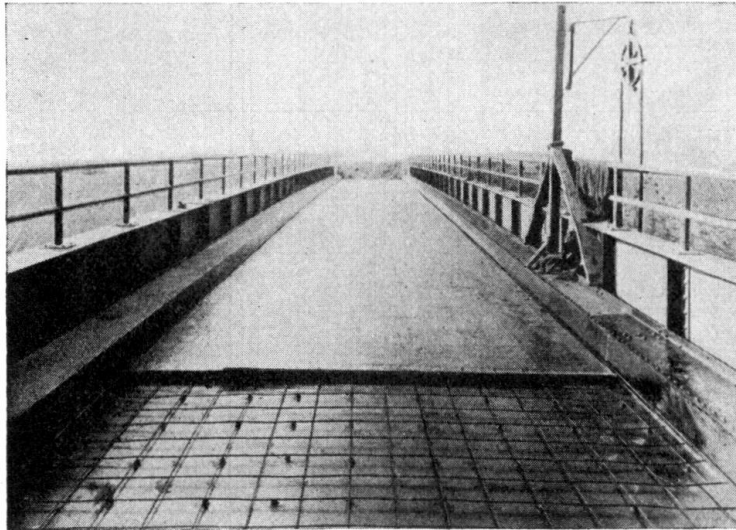

Fig. 9.

Light floor — Schaper system.

these endeavours becomes indubitable, even though the cost of the lighter construction may often be considerably higher than that of the type of decking hitherto in use. The economic problem is by no means settled merely by answering the question whether the reduction in weight and cost of the main girders

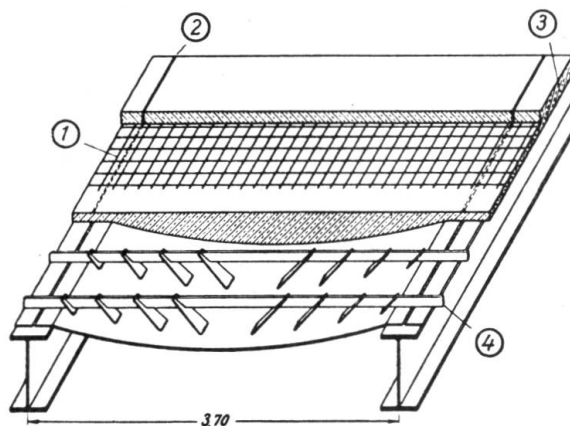

Fig. 10.

Stiffened arch-plate.

- ① Intersecting reinforcements on steel plate.
- ② Longitudinal joints over the longitudinal girders.
- ③ Concrete containing 300 kg of cement per m³ deposited in a single layer.
- ④ 80 × 8 mm flat steel bars at 45 cm centres.

through adopting a lighter decking balances the greater cost of the latter, for, as already indicated, many cases arise where the reduction in constructional depth may be the deciding factor. Moreover it is relevant to point out that the economy of this new method of construction depends on the use of special workshop

use replaces the shuttering which is otherwise necessary in building a reinforced concrete floor.

Further experiments must show how far it is necessary to stiffen the plates where these take the form of *trough plates* (3.5×5 m) under a covering of

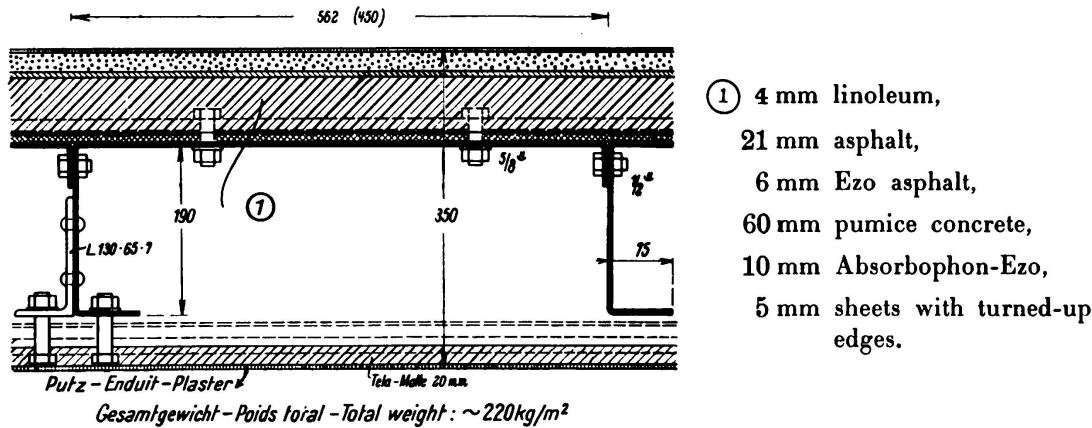

- ① 4 mm linoleum,
- 21 mm asphalt,
- 6 mm Ezo asphalt,
- 60 mm pumice concrete,
- 10 mm Absorbophon-Ezo,
- 5 mm sheets with turned-up edges.

Fig. 13.

Light steel floor.

special materials with the possible addition of a wire netting, and with the use of a special working procedure. The question of troublefree maintenance of the continuous layer of concrete over the floor girder may be a matter of some considerable difficulty unless a gap has been left for the purpose.

The form of bridge construction illustrated in Figs. 11 and 12, in which there are no cross girders but the joists are *embedded in concrete*, may also be looked upon as a form of lightweight construction. Measurements of deflection made on these joists and on the plates welded to them have shown that the joists and the plates co-operate somewhat after the manner of T-beams in reinforced concrete. It is to be hoped that further measurement of deflection will show whether in the design of a construction of this type it is permissible to assume some width, of plate as co-operating with the joists, or whether an increased deflection, say $1/700$ instead of $1/900$, may be allowed in the joists themselves.

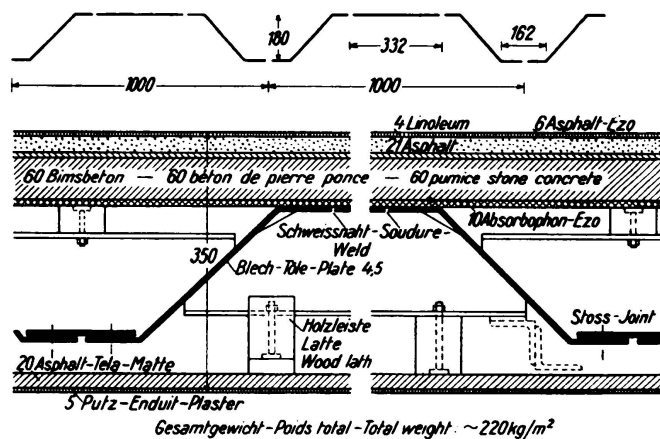

Fig. 14.

Light steel floor with doubly bent steel sheets.

In building work *light floors* as shown in Figs. 13 and 14 have been used, after careful tests under load and investigations of their acoustic and thermal properties have proved their suitability. The dead weight amounts to only about

220 kg/m² for a span of 6.50 m, a depth of 350 mm, and a live load capacity of 500 kg/m². The construction is readily adaptable to different conditions of loading and span by altering the thickness of the plate and the other dimensions,

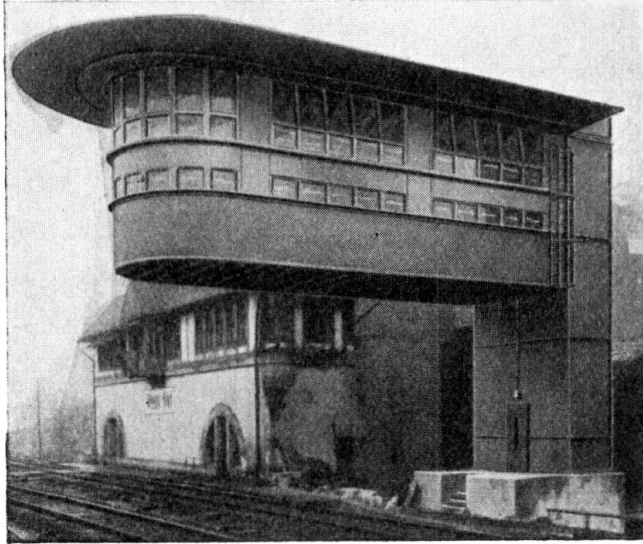

Fig. 15.

Signal box at Mainz station.

and this can be done very economically. The lightness of such a floor is an aid to new methods of constructing steel building frames with partial use of welding, and an example of this is provided by the two-storeyed signal cabin at Mainz (Fig. 15) in which the plating serves both as a curtain wall and as a cantilever girder.

As regards new design of aircraft hangars, reference may be made to Fig. 25 on page 1323 and Fig. 24 on page 1321 of the Preliminary Publication. In America suspended plates have been used for roofing over a bunker with the aid of welding.³

Fig. 16 shows an example of development in aircraft hangar construction in Germany, in which the self-supporting roof constructed of troughing with tie bars serves also as the upper flange of a truss which is well adapted to carry point loads, and the lower flange is provided in the form of a tie bar. Considering the advantages of a steel roof-covering the weight of this type of construction is surprisingly low. Surface structures (as, for instance, roofing over halls) which are stressed mainly in compression throughout their effective cross section, and which are kinematically sensitive, require special investigations of stability (theory of the second order) as relatively small differences between the original and the actual shape of such a system may have a decisive effect on its safety. Fortunately steelwork construction is not affected by the phenomena of deformation due to the material itself.



Fig. 16.

Self-supporting roof formed of doubly bent steel sheets.

Surface structures (as, for instance, roofing over halls) which are stressed mainly in compression throughout their effective cross section, and which are kinematically sensitive, require special investigations of stability (theory of the second order) as relatively small differences between the original and the actual shape of such a system may have a decisive effect on its safety. Fortunately steelwork construction is not affected by the phenomena of deformation due to the material itself.

³ Stahlbau, 1933, p. 152, N^o. 19.

In the construction of large halls, as for instance the new airship hangars at Frankfort on Main and at Rio de Janeiro, the trussed form of construction still predominates.

Further attention has been paid to the co-operation of steel construction and concrete. In Switzerland small road bridges (Fig. 17) have been made with the upper flange of the main girders and the longitudinal girders embedded in the reinforced concrete slab: the combined action enables the longitudinal girders to be made lighter and also has a favourable effect on the natural condition of vibration of the bridge. There are also special cases (as where St. 52 is used) where the compound action serves to reduce the amount of steel otherwise involved in the larger girders necessitated by considerations of deflections. In Germany the Reinforced Concrete Regulations do not allow this co-operation between rolled steel joists and concrete to be taken into account unless the joists lie entirely in the tension zone, and apart from this the Reichsbahn insists on permanent accessibility of the rivets in the flanges, a requirement which operates in favour of welding.

In the design of steel building frames, the use of which has become particularly widespread in France and Great Britain in recent years and of which an example exists in the new construction of the Reichsbank in Berlin at the present time, it is permissible to allow in the design for the co-operation of steel columns with their concrete cores,⁴ and this results in increased economy. Here again the use of light flooring has proved very advantageous in certain cases. Finally a wide range of fire tests on loaded steel columns of full size, variously encased, yielded valuable results and have indicated that it is possible with limited means to attain a high degree of fire resistance⁵ in such columns (see DIN 4102, part I).

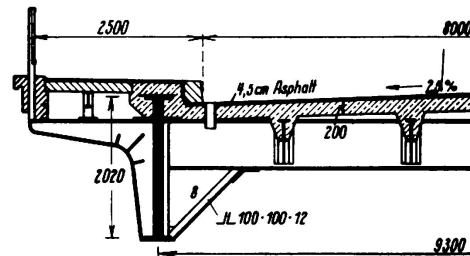

Fig. 17.

Bridge over the Limmat at Engstringen
(Switzerland).

⁴ Stahlbau, 1934, p. 59, Nos. 7 and 8; Zentralblatt der Bauverwaltung, 1935, N^o. 23.

⁵ Report on the XXIXth scientific meeting of the Reichsverein Deutscher Feuerwehringenieur (published by the same, Berlin, N^o 15).

VIIa 1

The Aesthetics of Steel Bridges.

Formgebung stählerner Brücken.

L'esthétique des ponts métalliques.

F. Eberhard,

Direktor der M.A.N. Mainz-Gustavsburg.

Increasing attention is now being paid to the aesthetic side of steel bridge design and the occasion is opportune, therefore, to draw a few examples and counter examples from the wealth of present-day practice and to examine them critically.

The fundamental principle of all architecture is to reveal closely the purpose of the structure, and to the bridge builder this means that the passage of the



Fig. 1.

Road bridge over the Rhine at Neuwied.

roadway over an obstacle must be clearly indicated. The purpose is best fulfilled when the roadway is carried above the structure, but to repudiate every solution in which this condition is reversed would be to go too far. For instance, in the case of the Rhine bridge at Neuwied (Fig. 1) if the roadway were placed above the bridge, the access ramps would have to be several kilometres in length and would predominate instead of subserving the road itself, forming a whole which would appear as a disturbing excrescence from the flatness of the landscape. The design of the bridge should not stop at the abutments but should extend to the continuation of the roadway, for only thus will the bridge be made to merge itself into the landscape, whether mountainous or flat.

As examples of typical bridges in flat country we may take the taut and slender looking plate girder structure which carries the Reichsautobahn over the Main at Frankfurt (Fig. 2) and the road bridge over the Elbe at Meissen

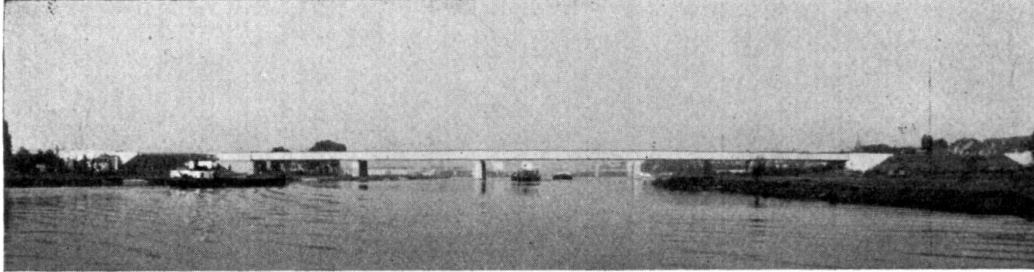

Fig. 2.

Motor road bridge over the Main at Griesheim.

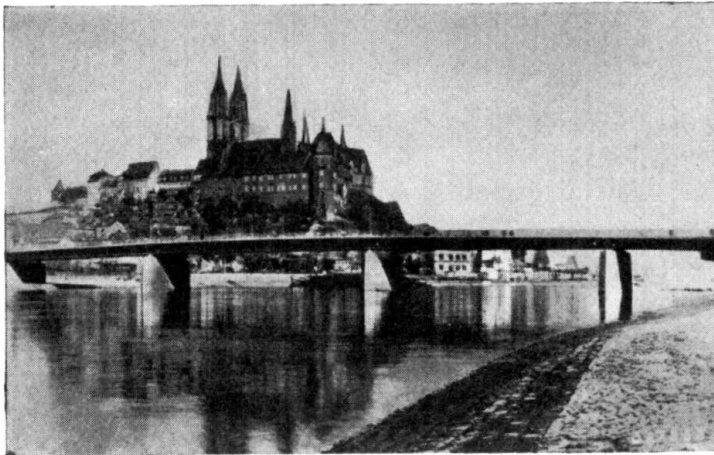

Fig. 3.

Road bridge over the Elbe at Meissen.

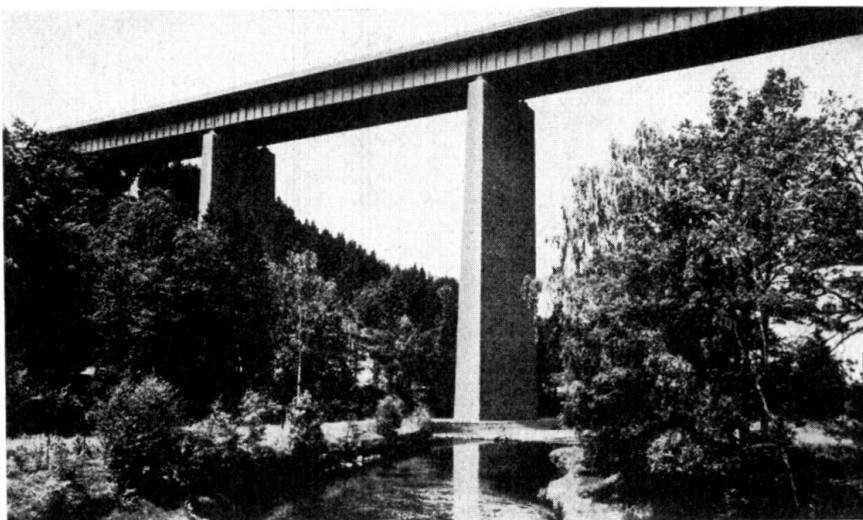

Fig. 4.

Reichsautobahn bridge at Siebenlehn.

(Fig. 3). The latter, with the picturesque Albrechtsburg in the background, illustrates that there is no need to imitate antiquity in order to harmonise the old with the new.

That the plate girder bridge is equally capable of merging into a mountainous landscape may be seen from the Autobahn bridge over the Freiburger Mulde (Fig. 4).

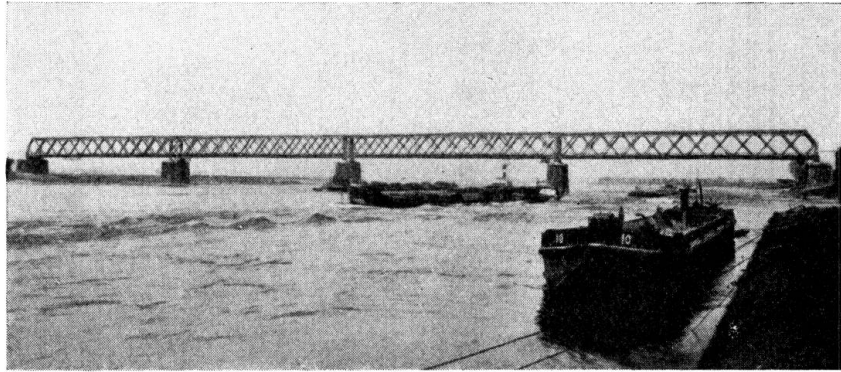

Fig. 5.

Railway bridge over the Rhine near Wesel.

A lattice girder, also, is capable of effective incorporation into either a flat or a mountainous landscape. This is illustrated by the railway bridge over the Rhine near Wesel (Fig. 5) and by the railway bridge near Freudenstadt (Fig. 6). The determining factor is not whether the bridge is solid or open webbed and not whether the country is flat or mountainous; — art consists in laborious and

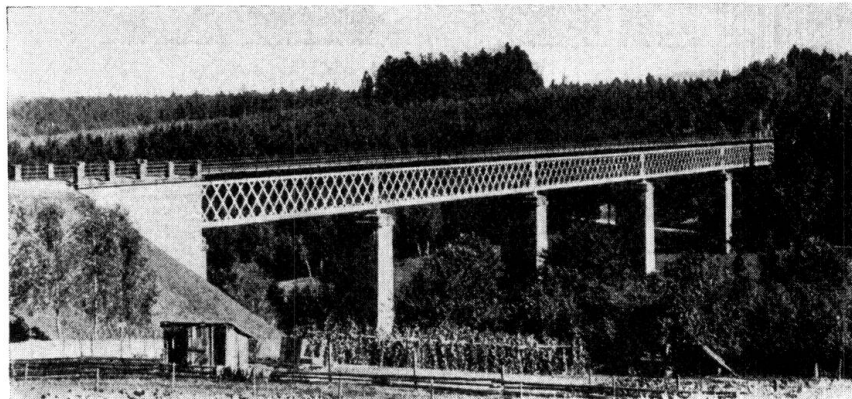

Fig. 6.

Lauterbad Bridge at Freudenstadt.

careful study to settle the height of the girders, of the spans, of the proportions of the piers and of the width of the bridge and its corbels.

In high bridges a parallel girder may very well be combined with an arch, for in such a case the arch predominates as long as an equilibrium between the abutment and the arch is obvious to the eye. The bridge over the Mälarsee near Stockholm, otherwise pleasing (Fig. 7), suffers from the defect that too little of the abutment can be seen.

The bridge over the North-East Sea Canal near Grünthal (Fig. 8) owes its appearance of boldness and elegance to the obviously right choice of the positions of the springings; at the same time the prominence given to the



Fig. 7.

Road bridge over the Mälär Lake near Stockholm.

roadway line serves to mask the disadvantage of the road passing from above to below the arch.

The result is much less happy in those arch bridges where the arch rises above the roadway but fails to free itself therefrom. Thus Fig. 9 shows the

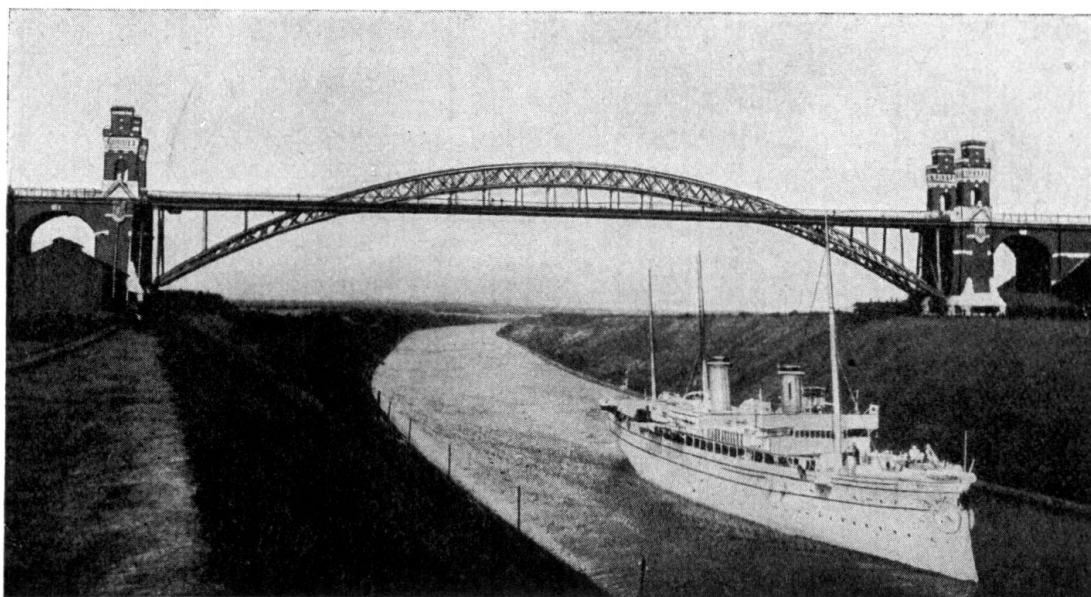

Fig. 8.

Road bridge over the North-East Sea Canal at Grünthal.

road bridge at Coblenz before reconstruction and Fig. 10 indicates how its appearance has since been improved by lifting and widening the floor. Whereas, in this bridge, all three openings are equal at 96 m, in the case of the Rhine bridge at Mainz the span increases from 87 m at the banks to 102 m in mid-

stream; but few people looking at the bridge will be aware that its faultless harmony is the result of this increase in the spans. Fig. 11 shows the bridge after its reconstruction. Originally the abutments carried toll houses and the

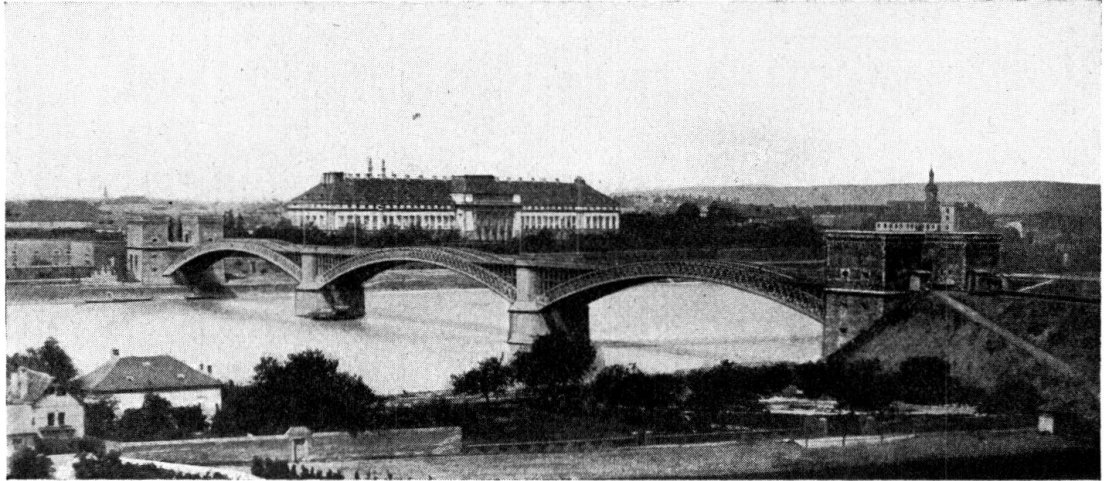

Fig. 9.

Road bridge over the Rhine at Coblenz before reconstruction.

piers ornamental pilasters which broke up the pleasant swing of the roadway and also its connection with the access ramps. The horizontal lines intersected the vertical, with mutual interference. To-day, however, the roadway, which it is the purpose of the structure to carry, clearly dominates the whole.

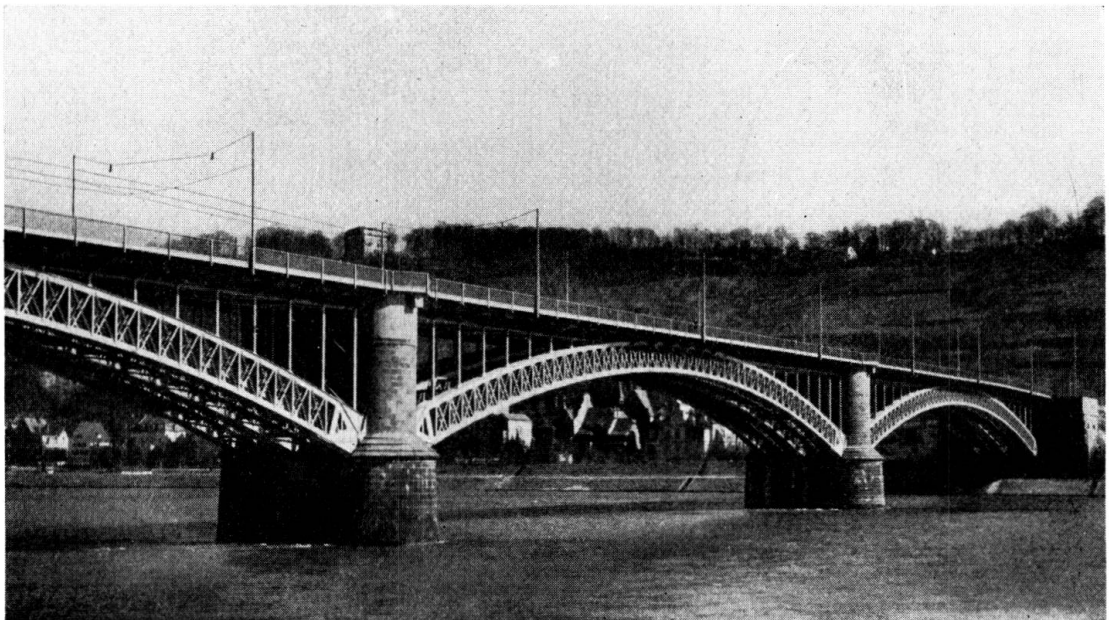

Fig. 10.

Road bridge at Coblenz after reconstruction.

It is not always that nature offers the bridge builder valleys anywhere nearly symmetrical in cross section, but where symmetry is lacking there need be no hesitation in exploiting the lack — which may, indeed, be a source of special

charm. The design for the Autobahn bridge over the Saale near Lehesten (Fig. 13) is characterised by the fact that the span increases towards one side and that the roadway is on a gradient, making it possible to increase the height of the girder to correspond with the increase in span.

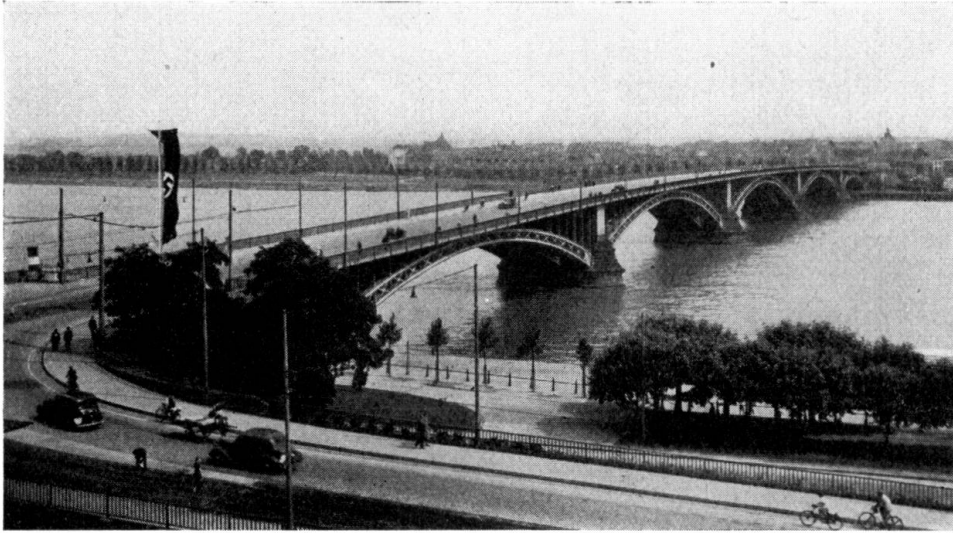

Fig. 11.

Road bridge over the Rhine near Mainz after reconstruction.



Fig. 12.

Road bridge over the Rhine near Mainz before reconstruction.

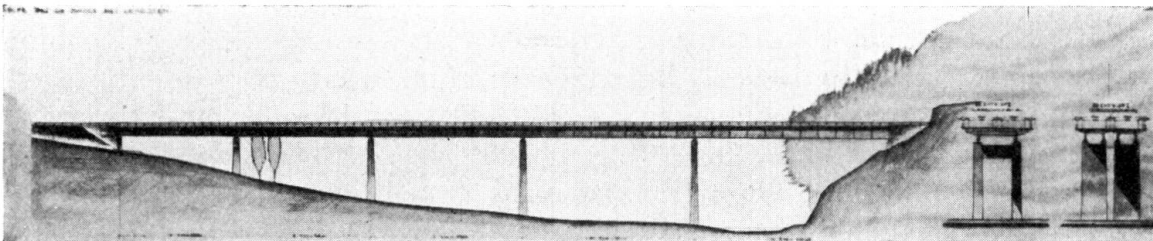

Fig. 13.

Design for a motor road bridge near Lehesten.

When the designer is prevented by conditions laid down by other agencies from following his own rules the problem of creating a harmonic structure becomes almost insoluble. The Rhine bridges near Maxau and Speyer (Fig. 14) are subject to unfortunate conditions of this kind, for the curvature of the river causes the navigation channel to lie on one side and the river must

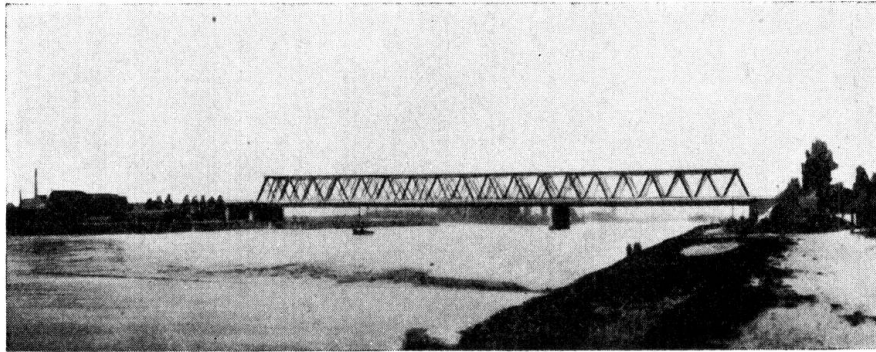

Fig. 14.

Bridge over the Rhine at Maxau.

be placed accordingly; to an onlooker, however, this lack of symmetry is incomprehensible as the reason for it is not apparent. It was found that the dominating horizontal lines of a beam bridge would emphasise the lack of symmetry least, whereas an arch (Fig. 15) would have emphasised it more.

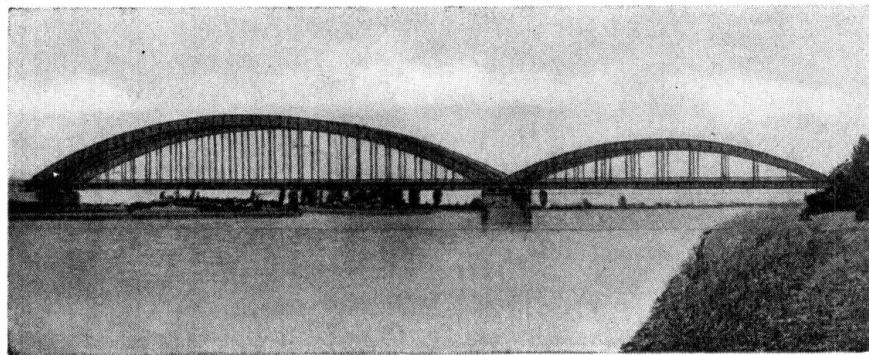

Fig. 15.

Design for bridge over the Rhine at Maxau.

Bridges over several openings must be unified into a closed line. Note the difference in this respect between the old lattice bridge at Cologne (Fig. 16) — despite the disturbing superstructures over its piers — and the jagged outline of the bridge across the Danube at Floridsdorf (Fig. 17).

Another way that the unity of line of a bridge may be completely broken is through lack of repose in the outline of the booms, as in the case of the Hassfurt bridge over the Main (Fig. 18). The road bridge at Wesel (Fig. 19), again, loses something through the circumstance that the booms rise above the river piers, and the disturbance caused by the dropping of the line of the roadway at these same places is a further defect.

How neat the old girder bridges with thin members could be has already been illustrated in the lattice bridge at Cologne. Hence the revived use of solid webbed girders, and the quest for means of filling the spaces in trussed girders so as

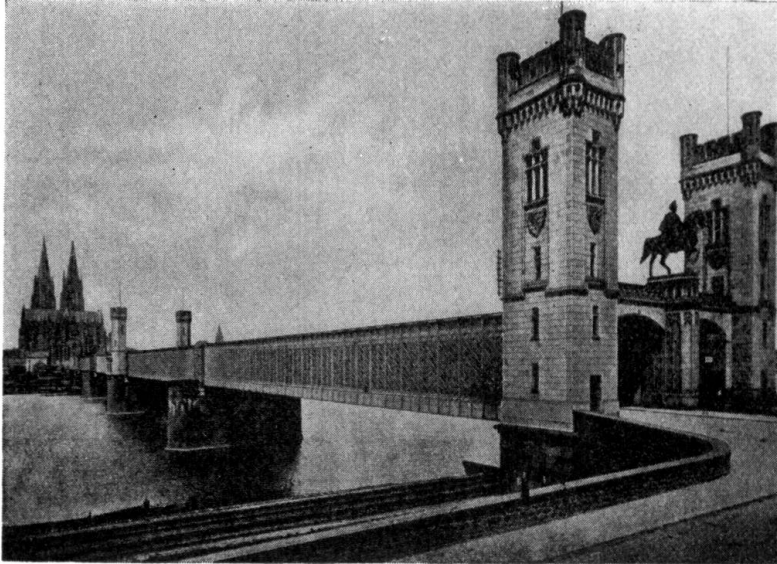

Fig. 16.

Old railway bridge over the Rhine at Cologne.

to recapture the attractiveness of the old fine-membered lines. The reintroduction of the truss with simple diagonals only is a step in this direction.

The truss with diamond (rhombic) lattice is more effective in that the girder takes on more the appearance of a wall. In the Rhine bridge at Mannheim

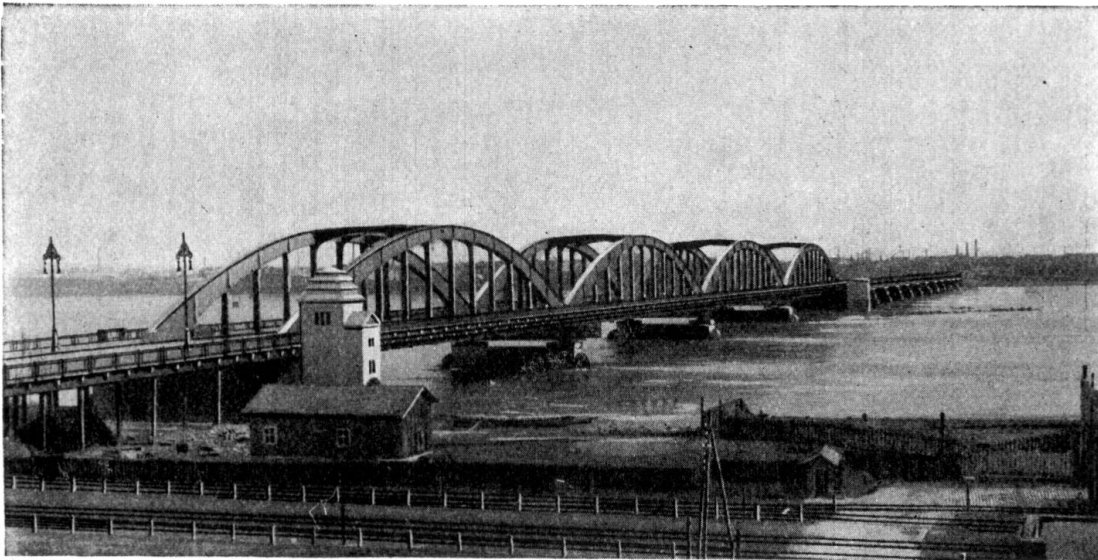

Fig. 17.

Bridge over the Danube at Florisdorf.

(Fig. 20) the end posts are carried to the full height of the girder. This gives a somewhat harsh appearance and it is better therefore, to finish off the end

posts at half the height as in the railway bridge at Wesel (Fig. 21). An end portal with a kink in the uprights pleases neither the engineer nor the layman.

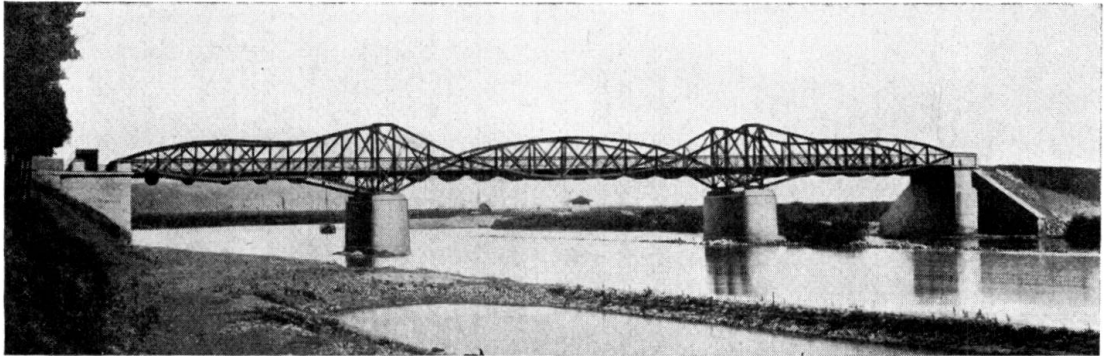

Fig. 18.

Road bridge over the Main at Hassfurt.

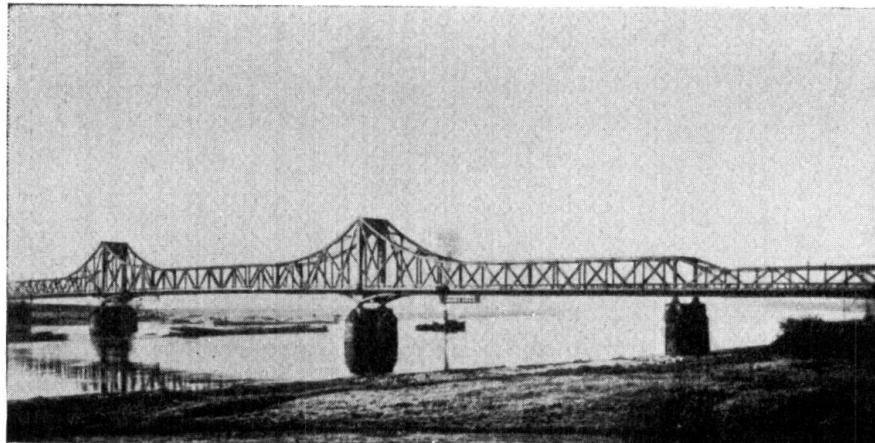

Fig. 19.

Road bridge at Wesel.

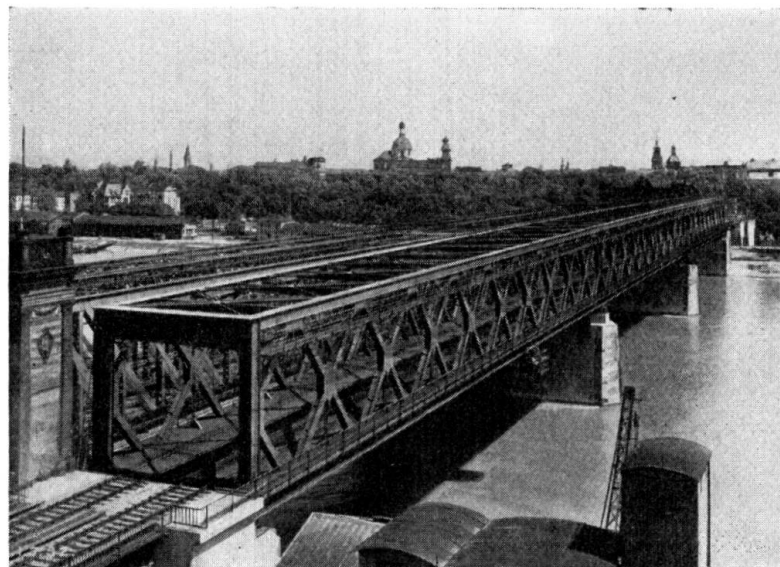

Fig. 20.

Road bridge over the Rhine at Ludwigshafen.

The search for a new way of shaping the panels of a truss is a problem of modern engineering which calls for solution through the combined efforts of the engineer and the architect. But the principle of combining a beam with an

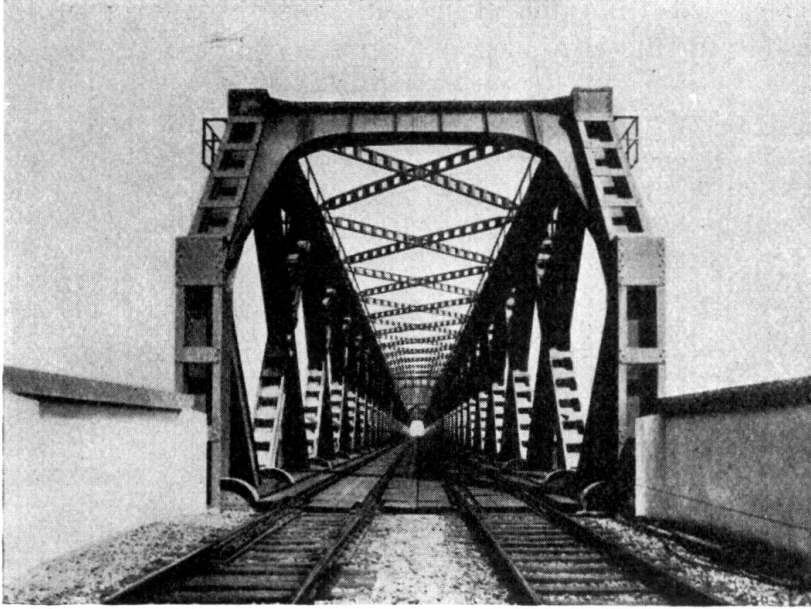

Fig. 21.

Railway bridge at Wesel.

arch seldom leads to happy results — for how is the spectator to know that an arch with a tie has vertical reactions similar to a beam? And who is to answer his question whether it is the arch or the stiffening girder that is the



Fig. 22.

Footbridge at Oberschöneweide.

principal member? It is only in a girder bridge strengthened with an arch, when one principal opening is specially emphasised by the arch, that this type of bridge can be satisfactory. Fortunately we have learned to avoid arbitrary

mixtures of arches and beams, and opposing curves in the lines of the booms, while for such a structure as the footbridge at Oberschöneweide (Fig. 22) our technical terminology has not even a name. In the North Elbe bridge at Hamburg (Fig. 23) the roadway appears to the layman as if it were an afterthought incidentally suspended from the structural parts. Structures of this kind are largely responsible for the false idea, not yet everywhere dead, that a steel bridge

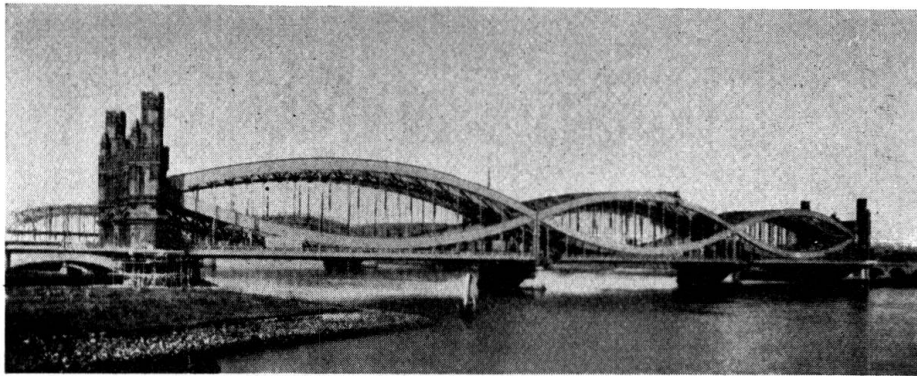

Fig. 23.

Bridge over the Elbe at Hamburg.

is no more than a makeshift for adoption where a massive bridge cannot be built.

Nor can a mixture of beam and suspension bridge give satisfaction. In the Main bridge at Bamberg (Fig. 24) the suspension boom, which is the most purely tensile member, has its central portion functioning as the upper flange

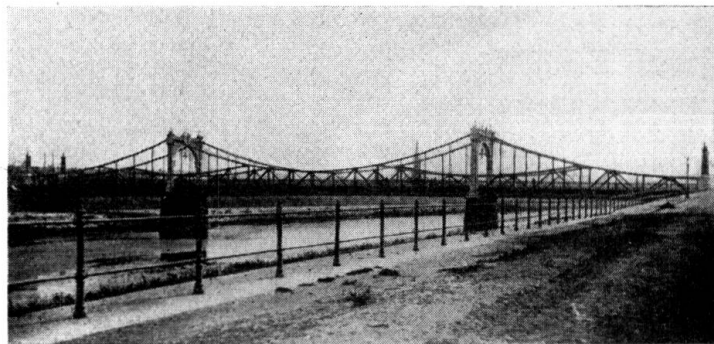

Fig. 24.

Road bridge over the Main at Bamberg.

of a beam, and therefore as a compression member: hence the confusion in the result, for no member ought to be called upon to serve two contrary functions at the same time.

The pure suspension bridge which the engineer is naturally inclined to use for long spans is all the more attractive in appearance because it is obvious that the towers carry the suspension cable, the roadway hangs from the suspension ties, and the stiffening girder carries the loads. How great are the constructional

possibilities of such a design is illustrated by the towers for the Philadelphia-Camden bridge (Fig. 25) and by the Rhine bridge at Cologne-Mülheim (Fig. 26).



Fig. 25.
Philadelphia. — Camden bridge.

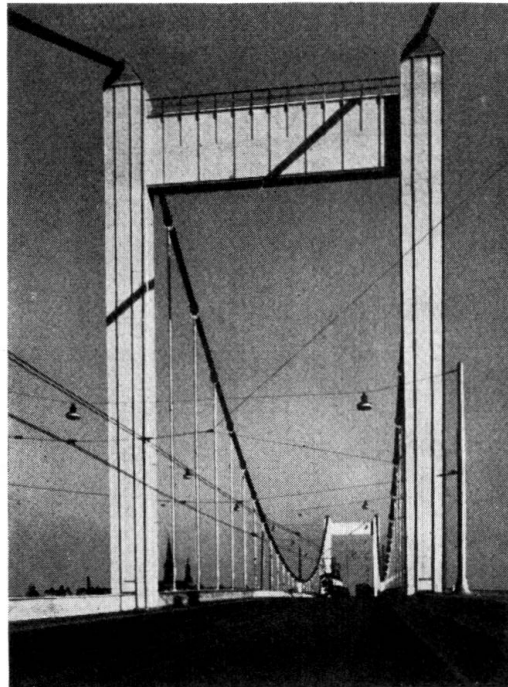

Fig. 26.
Bridge over the Rhine at Cologne-Mülheim.

The abutments and piers are a constituent part of a bridge, and it is often a matter of lively debate whether steel, masonry or concrete piers are to be preferred for these. In this respect the bridges for the Autobahn have given rise

to an entirely new problem on account of their great width. The problem is not yet mastered, though some attractive solutions to it are now on record such as the Sulzbach bridge (Fig. 27) and the bridge over the Kleine Striegis (Fig. 28).

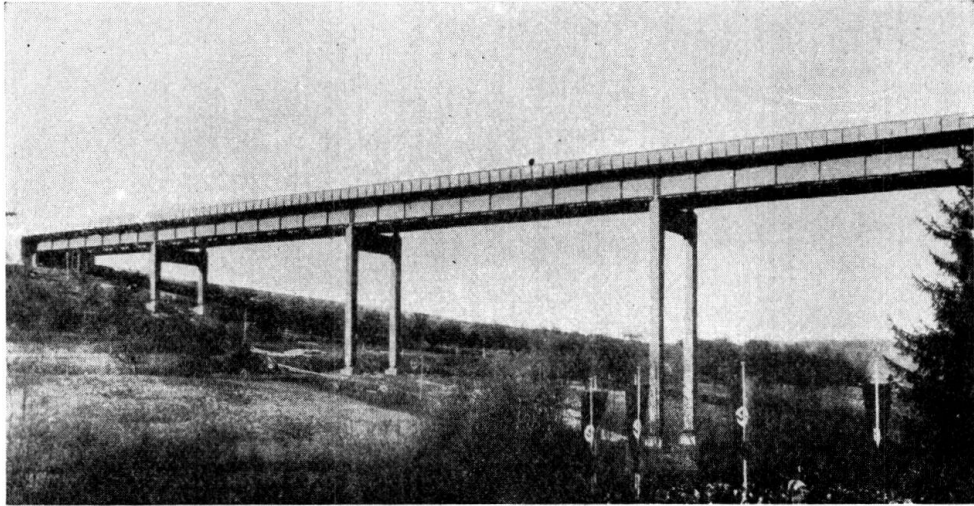

Fig. 27.

Motor road bridge over the Sulzbachtal.

The trend of design in steel bridge work is marked by a striving after clarity and truth in expression, and the problem of the bridge engineer is to choose from among those possibilities of statics and materials the ones which most naturally

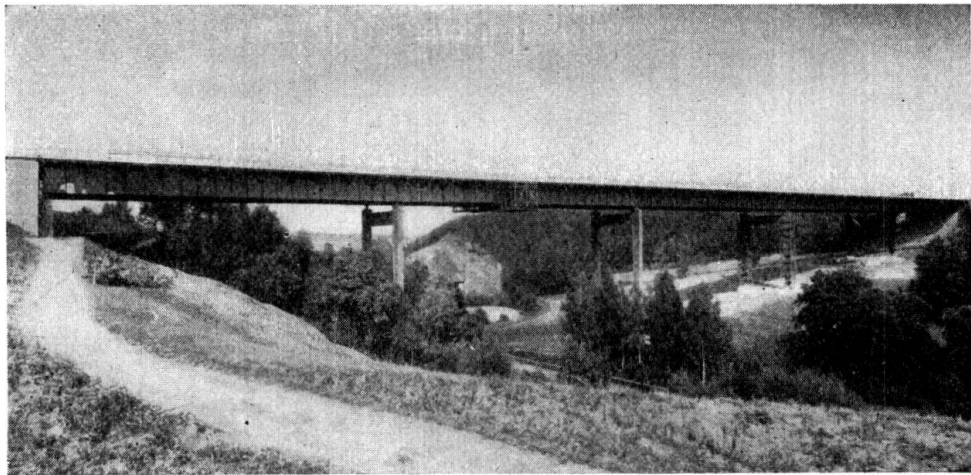

Fig. 28.

Bridge over the Kleine Striegis.

fulfil their purpose. A bridge is not a structure that stands alone but is part of a line of communication. It becomes a work of art when as a whole, and in all its members, it clearly expresses its purpose of carrying and guiding traffic.

VIIa 2

Unbuilt Bridges.

Brücken, die nicht gebaut wurden.

Ponts qui n'ont pas été construits.

Dr. M. Klö n n e,
Dortmund.

At meetings and in the literature, discussion is usually confined to structures which have actually been built, reference being made to their general arrangement, their constructional details and the advantages and disadvantages possessed by this or that type of work.

It is proposed here to direct attention to bridges which have never been built, or, more correctly speaking, to designs which have not been carried into effect at any rate in the particular circumstances for which they were drawn up.

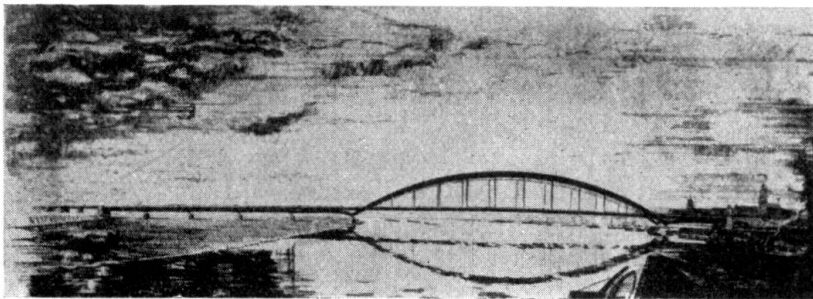

Fig. 1.

It will be suggested, moreover, that in the case of those designs which have gone no further than the design stage, it will often happen that either the external form or the underlying idea can successfully be taken up again later. The intention here is not so much to lament the tragedy of an idea being born before its time as to suggest to engineers that it is well worth while devoting attention to designs that have fallen by the wayside in competitions. Much thought of the highest quality is stored away in the prodigious labour applied to such designs by first class bridge builders, and it happens frequently that this may advantageously be drawn upon in other circumstances. This is true as regards both the design as a whole and the execution of its details.

The author wishes to declare at the outset his intention of quoting the actual names of the works in question, and he trusts that this will be excused

by his colleagues, as he considers such a course more useful than mere mention of the designs without closer designation. He also asks for indulgence in mentioning mainly works, to the design of which he himself contributed.

First a few examples will be given of the general arrangement of bridge design.

In the competition for the Rhine bridge at Cologne-Mülheim an arched design was proposed (Fig. 1) which, having a span of more than 300 m, would have resulted in a bold and remarkable structure. Perfectly feasible technically, it would have had the advantage of allowing motorists on the bridge an unobstructed view of the river (Fig. 2). For reasons which would take too long to explain here, a suspension bridge was chosen instead.

To carry the Autobahn over the Elbe at Hohenwarthe, the author proposed a suspension bridge (Fig. 3), the lightness of which would have harmonised excellently with the long lines of the approach spans (Fig. 4). Actually a lattice girder bridge was built instead.

For the Elbe bridge at Dömitz he suggested a truss bridge in which all the web members would have been struts of equal inclination (Fig. 5). As there were to have been only two main girders, the

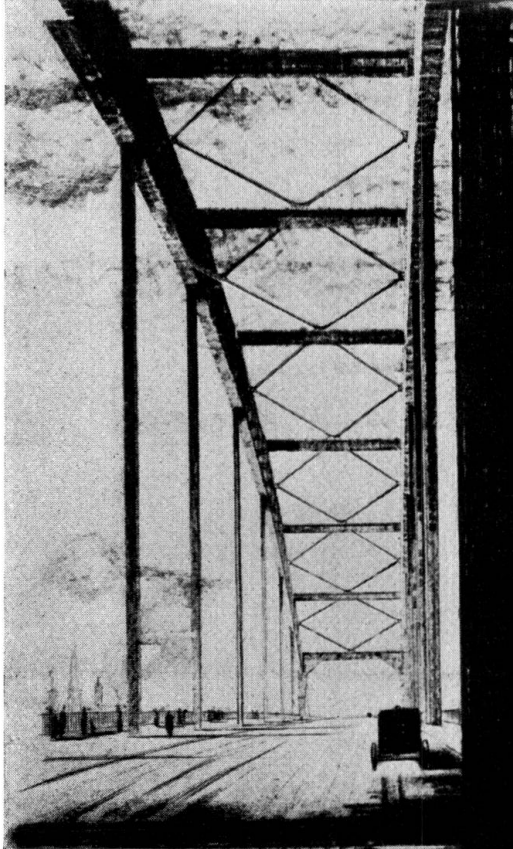

Fig. 2.

effect even of an oblique view through them would have been one of repose. The design actually chosen was a bow-string girder bridge.

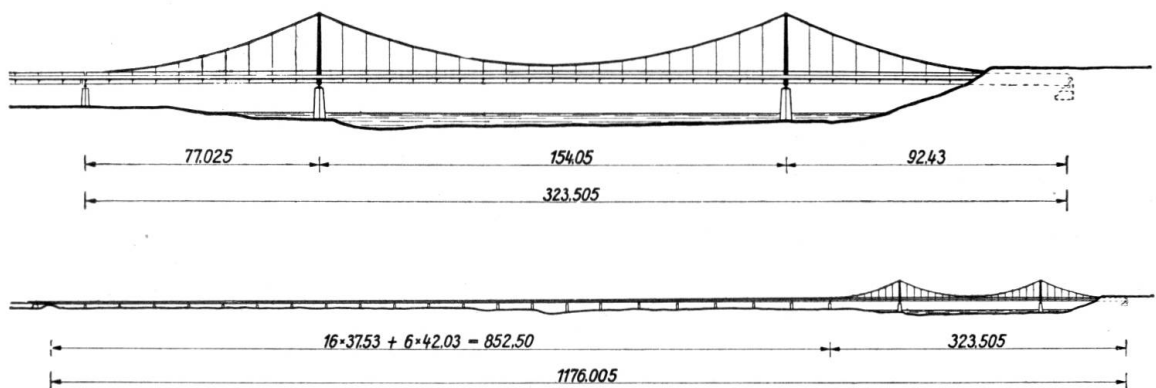

Fig. 3. (Dimensions in metres.)

This completes the circle from arch bridge to suspension bridge, from suspension bridge to trussed girder, from trussed girder to bow-string girder.

Although in these cases the wide-span arch bridge and the suspension bridge were not in fact carried out, the author believes that some day an opportunity will arise to make use of ideas embodied in these old designs and to apply these structural systems in similar cases elsewhere.

What is true of designs as a whole is also true, perhaps even more markedly, as regards constructional details. Here two examples will suffice.



Fig. 4.

In the construction of large viaducts with continuous main girders the recent practice has been to adopt tall steel hinged columns or hinged frames for the intermediate supports. In Figs. 6 and 7 a comparison is drawn between this form of construction and the use of slender concrete piers, designed for the Mulden bridge at Siebenlehn. The use of hinged portal frames of great height came originally from a suggestion made by the author in reference to the

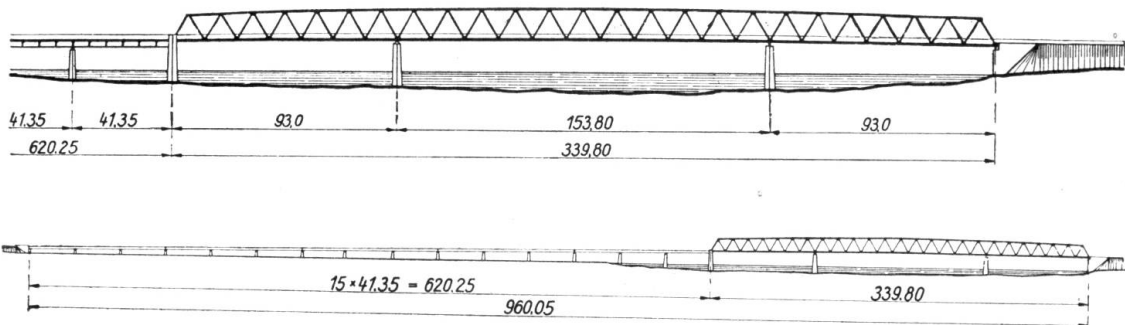

Fig. 5. (Dimensions in metres.)

Mangfall bridge, which on that occasion was not adopted. Figs. 8 and 9 are an elevation and a view from underneath of the bridge, showing the two alternative designs of solid-webbed and open webbed main girders.

The second example that may be cited in this connection is that of the overhead wind bracing. There can be no doubt that from an aesthetic point of view the Vierendeel form of bracing is very attractive, its plain cross members without diagonals giving an effect of repose. In 1934 the author proposed an

overhead wind bracing of this design for the Autobahn bridge at the Kaiserberg near Duisburg, but for statical reasons the deciding authority preferred a K-bracing. More recent bridges of this kind are in fact being built with Vierendeel

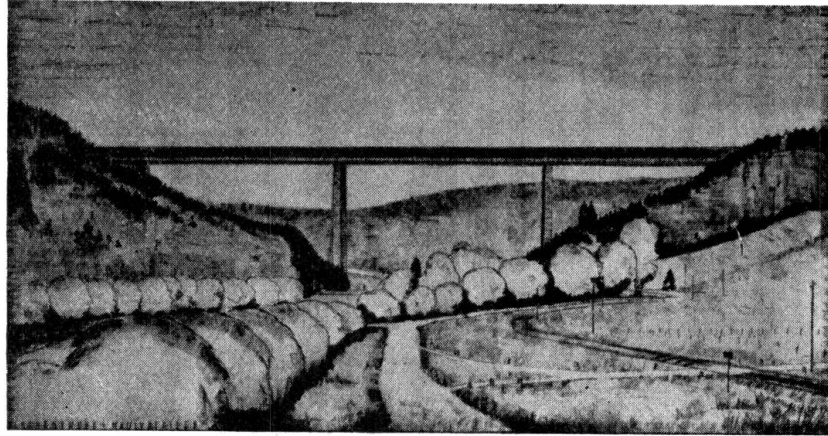

Fig. 6.

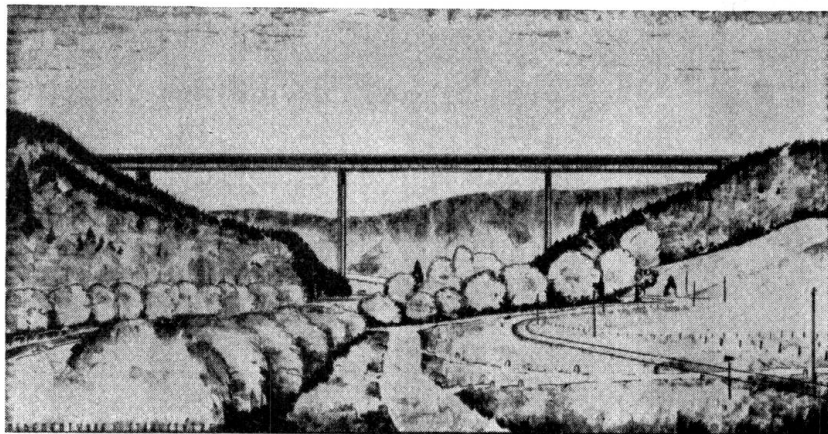

Fig. 7.

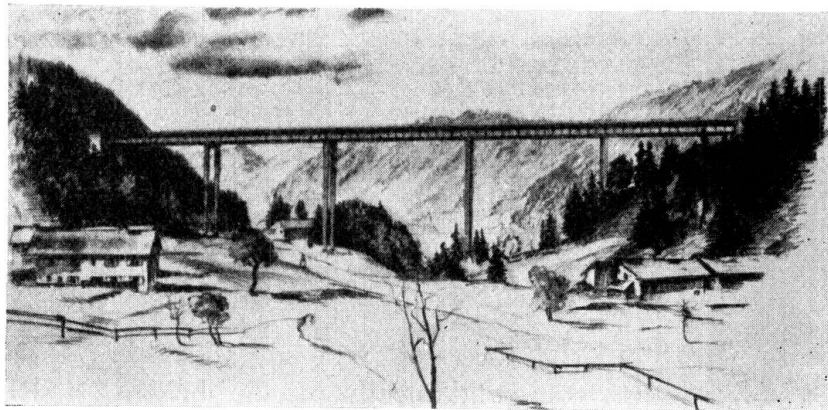

Fig. 8.

type of wind bracing, as, for instance, the Autobahn bridges over the Lech near Augsburg and over the Rhine-Herne canal near Duisburg, the latter having a span of 140 m.

Finally, a few words may be said on the subject of arch bridges. There are a considerable number of cases where an arch bridge is not only technically advantageous and competitive, but is also entirely satisfying from an aesthetic

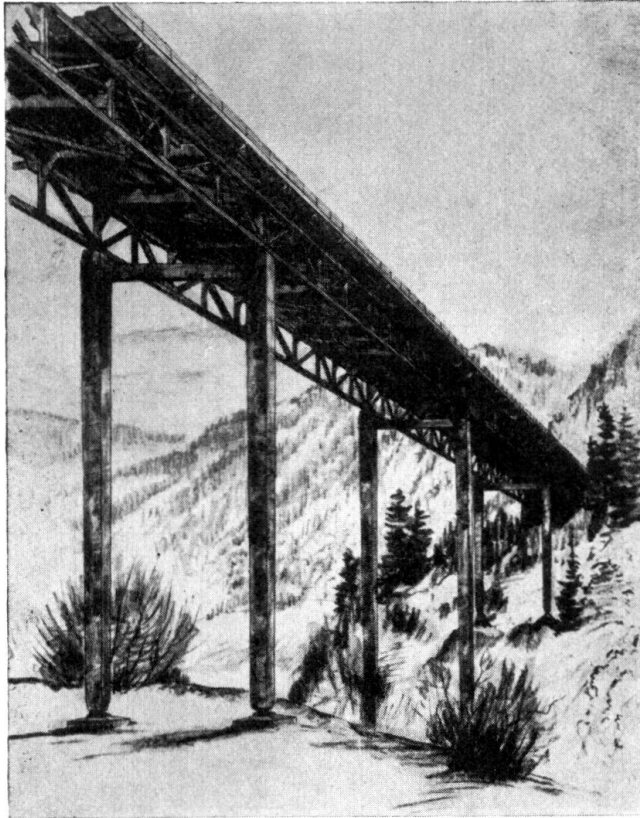

Fig. 9.

point of view, and if this were realised the present urge towards the adoption of nothing but parallel plate girder and lattice girder bridges might happily be varied. Here the author has in mind arch bridges properly so called (whether

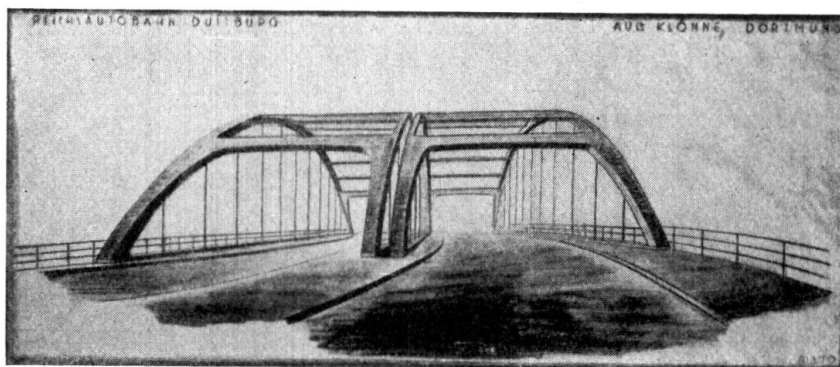

Fig. 10.

with or without a tie bar) as distinguished from girders stiffened by arches in which the girder dominates the design and emphasises the horizontal line. Even a "through" arch bridge (with the arch ribs rising above the roadway) may present a very attractive appearance. Apart from the example already given

of the arch design for the Cologne-Mülheim bridge, the author puts forward for comparison a design for an arched girder and one for a sickle girder,

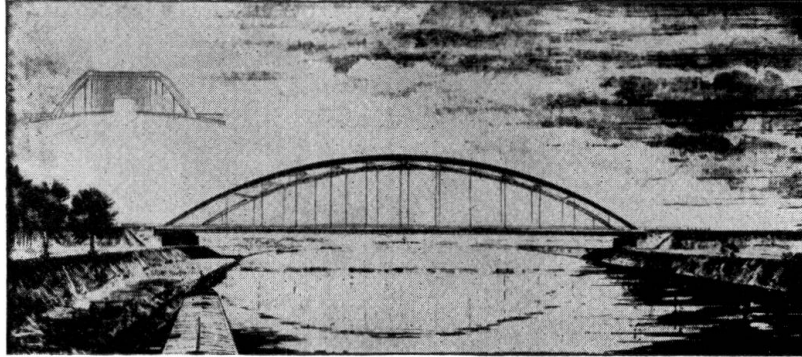

Fig. 11.

appearing in Figs. 11 and 12 respectively, which were worked out for the Rhine-Herne canal bridge.

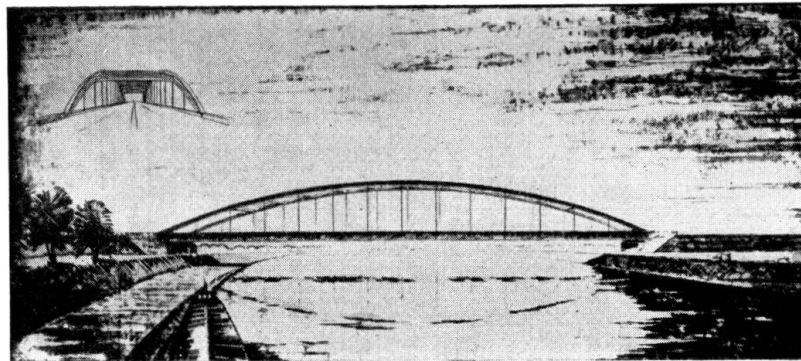

Fig. 12.

It is certain that the principal field of application for the arch bridge, whether of the sickle design or as a fixed arch, will continue to be that of bridging

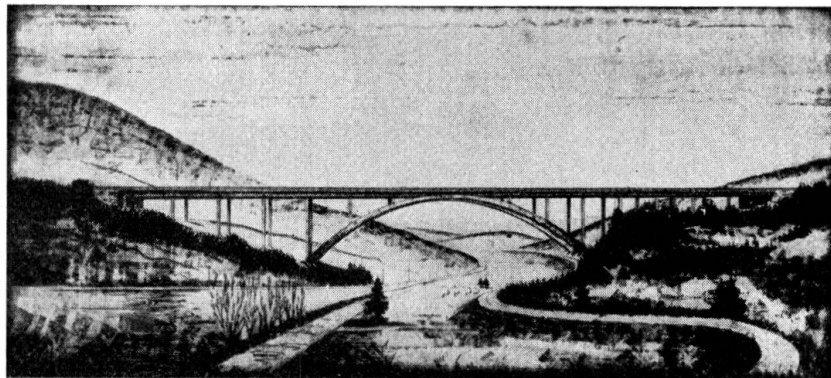

Fig. 13.

wide and deep valleys so that the whole of the arch may be placed below the level of the roadway. Fig. 13 shows a fixed arch for the Helderbachtal bridge,

which serves to illustrate how well this form of construction merges itself into the landscape. The principal dimensions of the design are indicated in Figs. 14 and 15, the former showing a transition from the arch to the girder and the

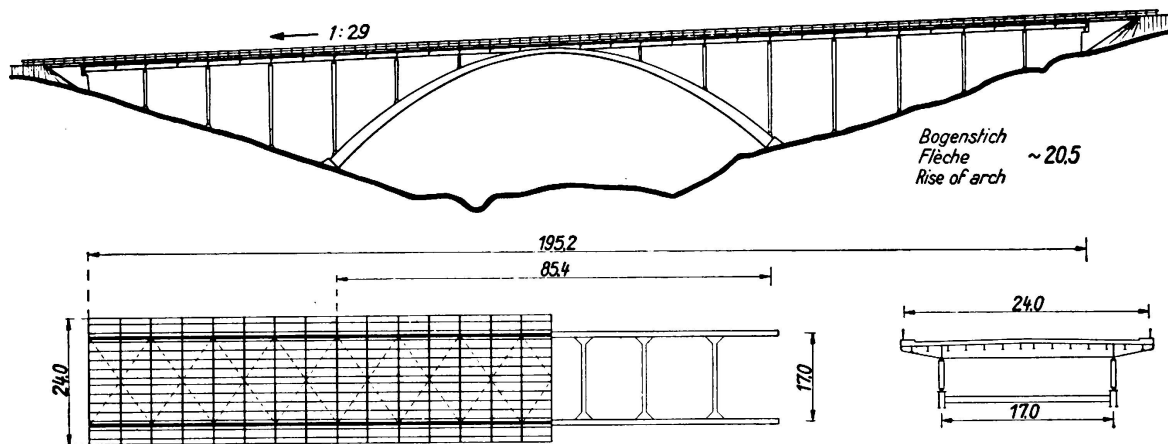

Fig. 14. (Dimensions in metres.)

second showing these two elements separated. The second form is the one which the present author prefers.

He hopes that these brief comments will have served the purpose of demonstrating that bridge designs which have not in fact been carried out are often worthy of notice, and may, indeed, predict future lines of development.

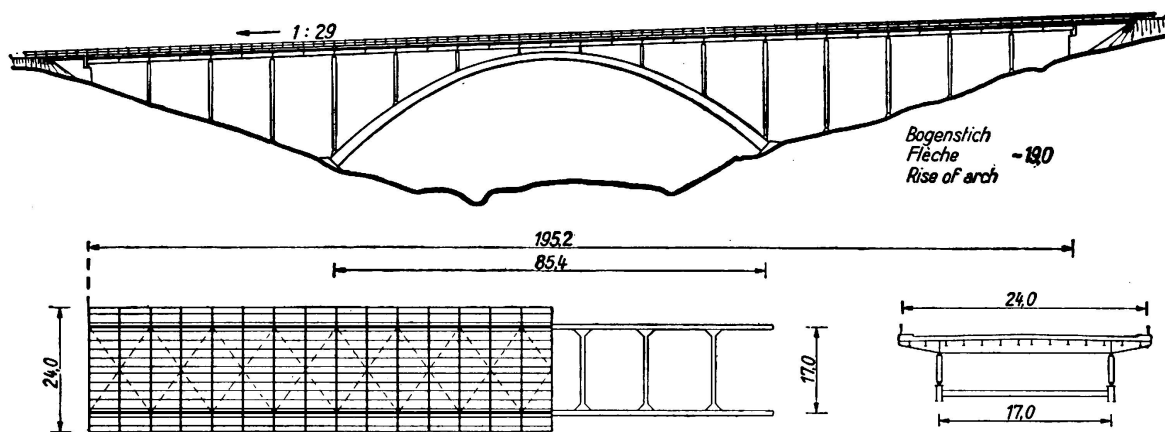

Fig. 15. (Dimensions in metres.)

We ought always to remember that bridges should be built not merely with a view to their structural performance; but, just as in appraising a man we look first for character, so should we expect to find that quality in a bridge. Such bridges cannot be “constructed”, they must be “created”.

The engineer thereby establishes his mastery, in that he brings the requirements of economy into harmony with those of beauty — a factor which he must never leave out of account.

VII a 3

Applications of Structural Steelwork in Italy.

Die Verwendung des Stahls beim Bau von Stahlkonstruktionen
in Italien.

L'application de l'acier aux constructions métalliques
en Italie.

Dr. Ing. A. Fava,

Chef de Service aux Chemins de fer de l'Etat, Rome.

1) It will be appreciated that in Italy the shortage of ore and coal render steel a very expensive material, and that its applications are consequently limited to those cases where it is an absolute necessity or offers special advantages by comparison with other materials, leaving many fields in which it is unable to compete against its rival, reinforced concrete.



Fig. 1.

2) One of the fields in which it is generally necessary to make use of steel is that of railway bridges which, frequently, are too low in height for the development of masonry arches or reinforced concrete structures. The Italian

State Railways system includes some 7000 steel bridges having a total length of nearly 100 km and during the last ten years about one third of these bridges have been renewed, a process which has usually involved the replacement of the existing spans by new ones except in the case of those of less than 10 m.

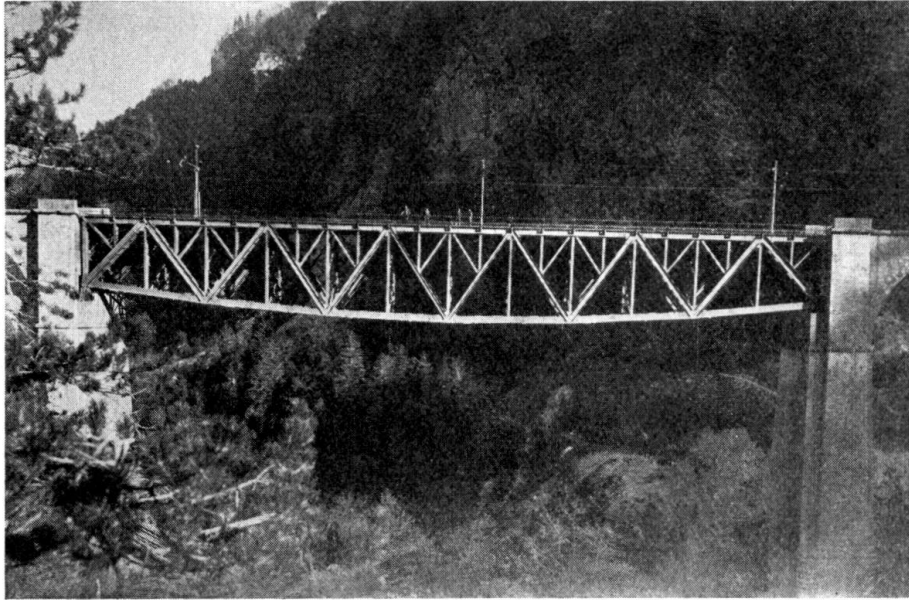

Fig. 2.

Fig. 1 shows a girder over three spans which may be considered as typical of recent work as regards constructional details. It will be seen that all the members consist of large section without small lattice work. The absence of the latter gives an effect of repose and great simplicity.

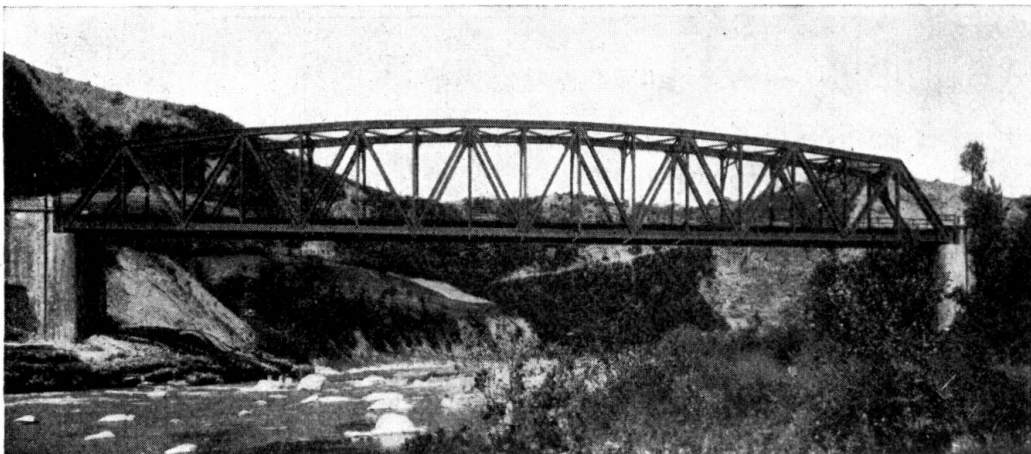

Fig. 3.

Fig. 2 shows one of the larger types of lattice bridges having a parabolic lower boom, and Fig. 3 a through span of about 90 m, again with a parabolic boom, which is representative of a great many bridges. Fig. 4 illustrates a continuous girder over two openings of 77 m each, with the exceptional feature

of intersecting diagonals in the main girders, this being adopted here as the most suitable arrangement in view of the bridge being very much on the skew.

In reference to this bridge it may be observed that for some time past the State Railways have abandoned the use of the continuous type of girder as it was found that in practice many such bridges underwent notable settlement of the supports, which seriously disturbed the distribution of forces. The continuous type is now again being adopted, but is made subject to careful

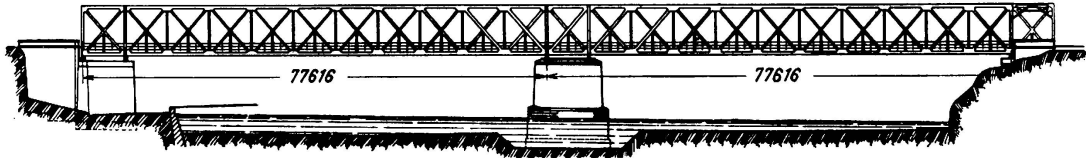

Fig. 4.

check of the levels of the supports. This is done with the aid of calibrated hydraulic jacks and precision manometers, whereby the span is lifted simultaneously from all of its supports and the respective reactions are adjusted to correspond with their theoretical values. In this way not only is it possible so to control the reactions that their values correspond to the several supports being on a level, but as an alternative it is possible to ensure experimentally,

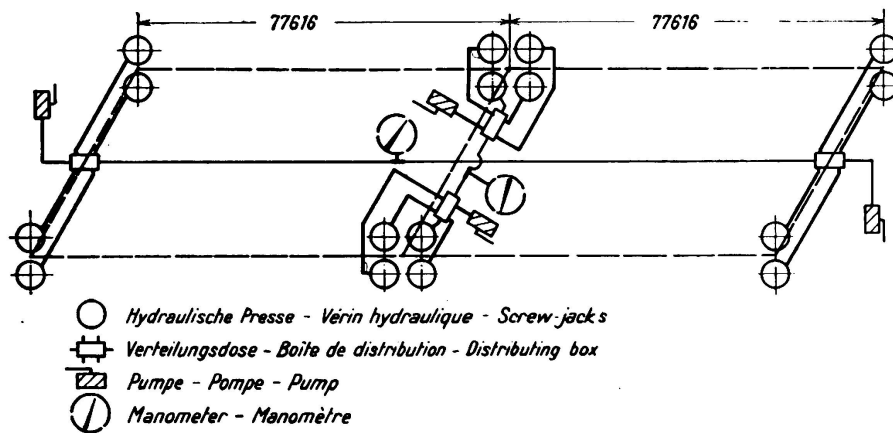

Fig. 5.

with every confidence, that the reactions assume any other values that may be the most expedient in order to obtain the greatest possible economy in the structure.

Fig. 5 shows diagrammatically the arrangement for setting the adjustment of these supports of the continuous girder illustrated in Fig. 4. The operation was combined with measurements of the stresses existing in different members of the structure, and it was found that had the adjustment not been made the reactions would have been very unfavourably influenced.

3) A very large number of public halls, varying in type, have been built entirely in steel, as well as steel framed buildings and roofs for civil, industrial and military purposes, during recent years. In this field of work welding,

especially electric arc welding, has fully established its position in Italy to such an extent that it may be expected in the course of a few years entirely to supersede the use of riveting.



Fig. 6.

From among the many examples which might be mentioned here we will take the steel roofs of the new railway station at Florence, which, at the same time, is a notable instance of modern welded construction.

These roofs are divided into two groups. The first of the latter, which covers the approach for motor cars and the booking hall, forms a structurally separate entity (Figs. 6 and 7). The supporting structure consists of eight large portal

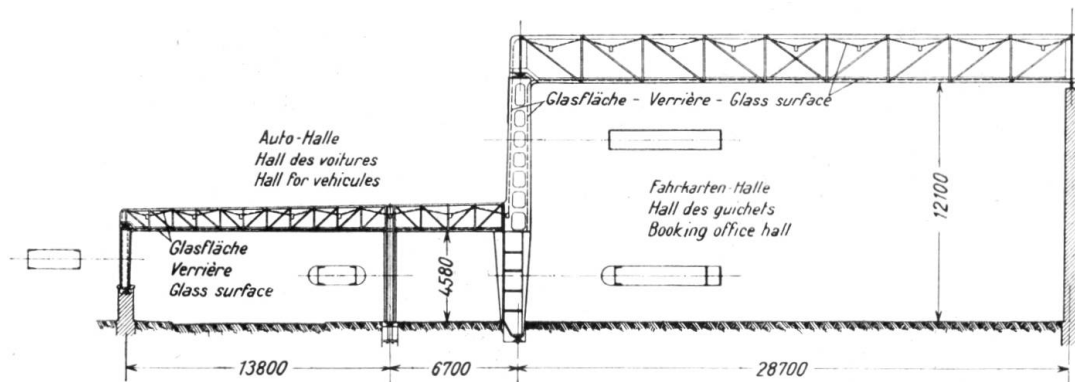

Fig. 7.

frames of three spans each, connected to one another by hinges in order to allow of thermal expansion. These carry two glass coverings, the outer one containing wire mesh glass and the inner one of Thermolux glass, both of them continuous horizontally and vertically, which gives a notable decorative effect. Between them are arranged the sources of artificial lighting for use at night. The outer glazing where it forms the roof has generally to be flat for architectural reasons, but to facilitate drainage it is built up of small elements slightly inclined to one another.

The second set of roofs at Florence is over the platforms and track (Figs. 8

and 9). Here the carrying frame consists of a series of large plate webbed girder spans of 30 m of varying double T section, built up of flat plates by welding.



Fig. 8.

For architectural reasons the shape of these girders is very special. They comprise three portions which are practically horizontal but at different levels, and are connected by steeply inclined portions. In view of the unusual shape

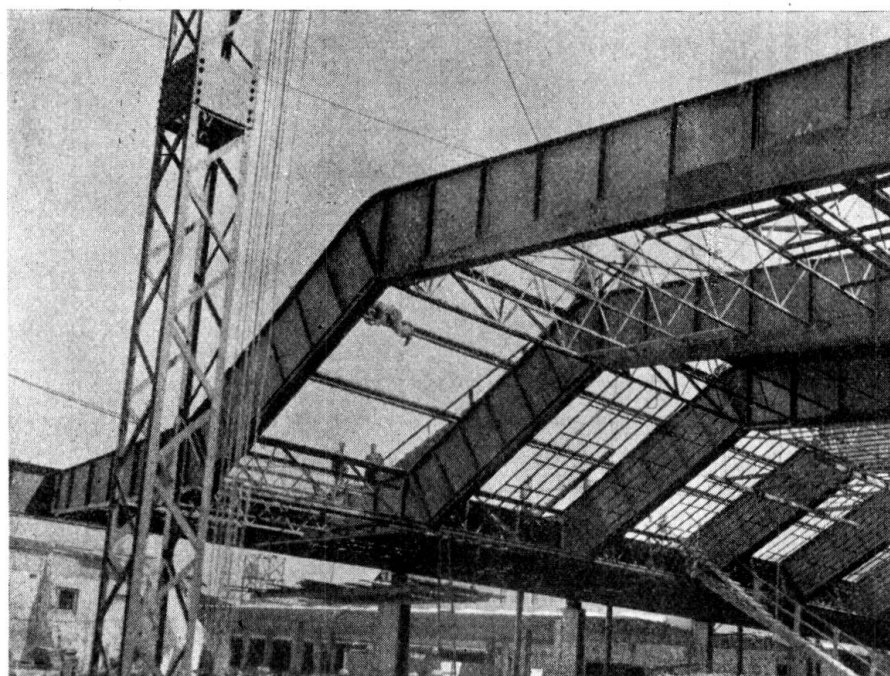

Fig. 9.

of these members their dimensions were decided after preliminary experiments on models, and after the work was completed they were made the subject of an accurate experimental investigation. All the visible portions of the steelwork at Florence have been copper coated and then burnished.

Another example of roofing is that over the public swimming baths at Milan (Fig. 10) which is notable also for the fact that a reinforced concrete construction was at first contemplated but that steel was preferred in view of

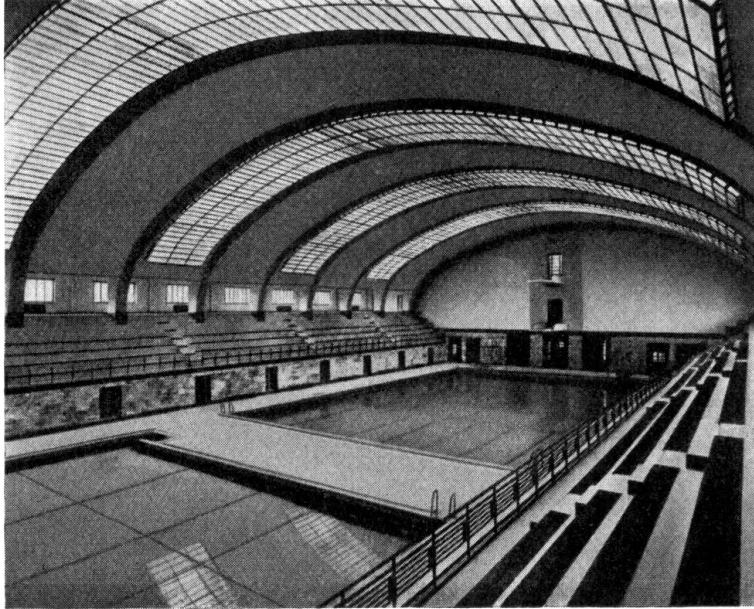

Fig. 10.

the very limited time available for carrying out the work. The arrangements for opening the glazed roof by remote control are ingenious, but these cannot be described here.

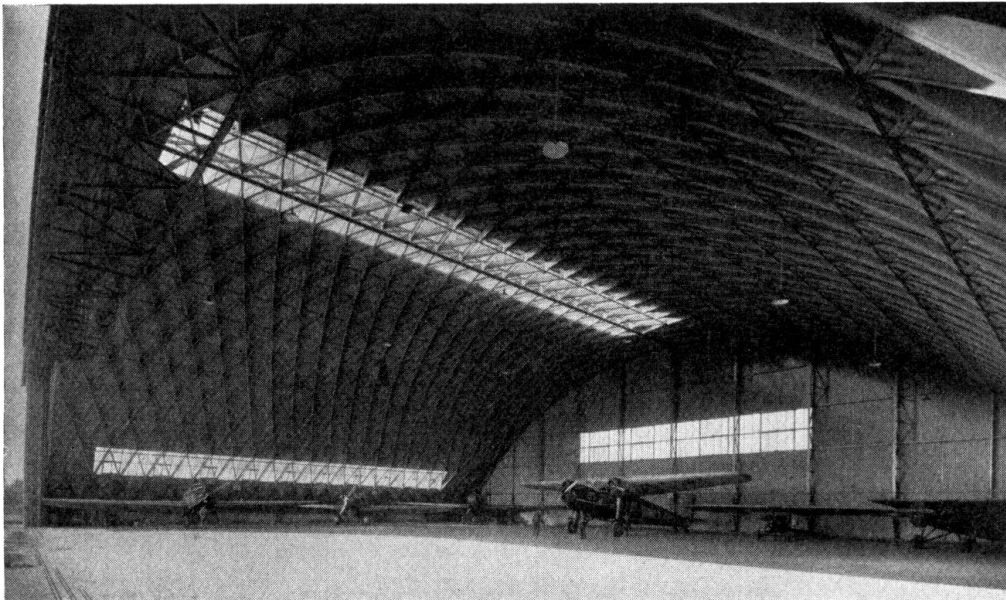

Fig. 11.

A special place among roofs is occupied by the type wherein the construction is of the coffered type. This offers not only a satisfactory solution to various technical problems but marked advantages from an architectural and aesthetic

point of view. There are some notable examples of these in Italy, especially over aircraft hangars and garages (Fig. 11).

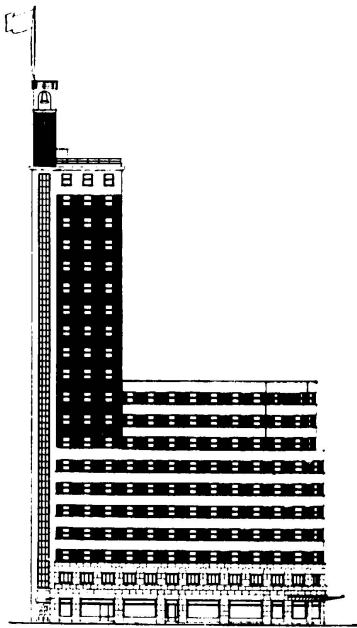

Fig. 12a.

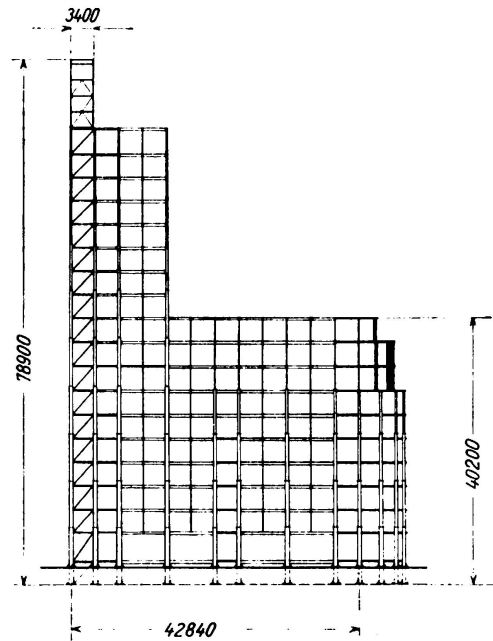

Fig. 12b.

4) In modern building practice the advantages of steel framing have become well recognised, but in Italy, on account of the high cost, steel framing is somewhat rare while concrete framing is common practice.

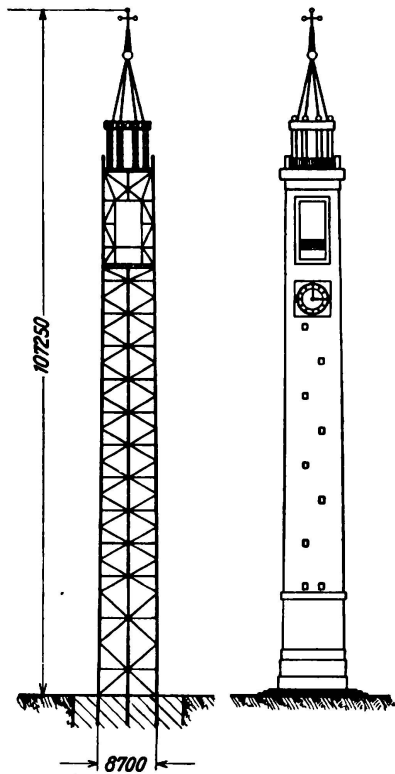

Fig. 13

An example of the latter, worth mentioning in view of its importance, is the new skyscraper at Turin (Figs. 12a and 12b) which is a large steel structure, entirely welded, reaching to a height of 80 m above ground level. Another is the bell tower at Sesto Calende (Fig. 13), some 100 m high and again of welded construction.

But rather than enlarge further upon these illustrations of rather special cases, it may be worth drawing attention to a field of work in Italy in which steel framed structures are assured of a promising future, namely that of earthquakeproof construction. Steelwork, in fact, possesses the best possible qualities for resisting seismic action — maximum lightness and maximum specific strength combined with a high degree of elastic deformability. It offers no less important advantages from a practical standpoint in that it can be manufactured in a few standardised types on an industrial scale by specialised works, and can be rapidly erected on the site by a few welders, thus reducing the call made upon local facilities which are often limited.

5) Arising from the extraordinary development of electrical installations in Italy one of the largest fields of application for steelwork is found in the construction of pylons for the transmission of energy. Allied to these, there may be mentioned, on account of the importance of the structural problems arising, the supporting towers for cable ways the number of which is continually increasing, and also aerials for wireless telegraphy and telephony.

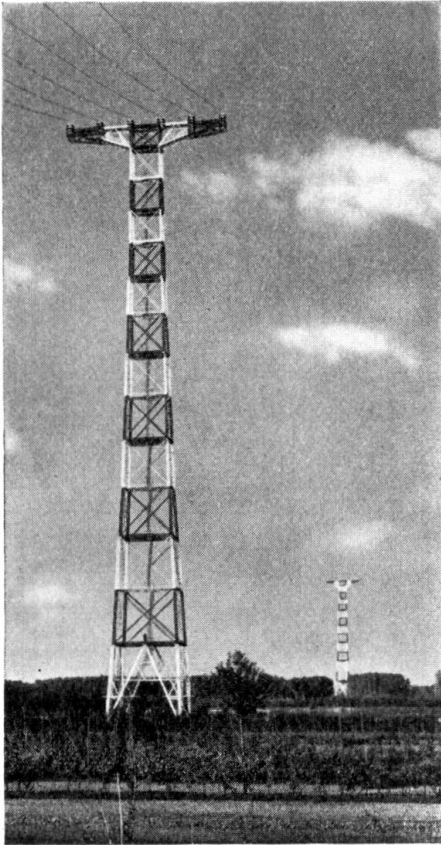

Fig. 14.

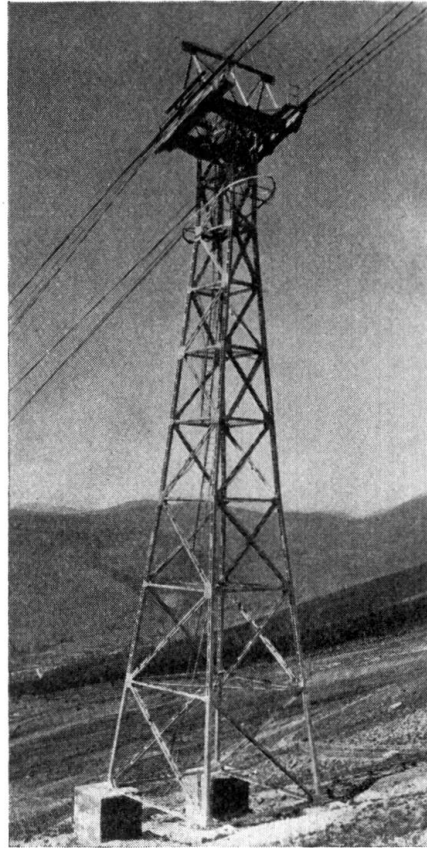

Fig. 15.

It would be of great interest to review different types of these structures as an outline of the process of evolution they have undergone in Italy, but having regard to the limited time available a few only of the most notable examples will be mentioned. Fig. 14 represents two high towers approximately 120 m above ground level for a crossing over the river Po with 1050 m span. Fig. 15 shows one of the modern pylons of welded construction to carry cable-ways namely those of the Gran Sasso d'Italia and Cervino (Matterhorn), wherein the spans are almost 1 km in length. Figs. 16a and 16b show the broadcasting station of Rome, San Palomba, which is one of the largest constructions of the kind. It reaches to the remarkable height of 267 m; the total weight of the aerial is 180 tonnes and the load on the insulator at the base is 290 tonnes.

6) A branch of engineering in which Italian industry has taken an important part is that of cranes for shipyards, factories and harbours. These are made of every kind and size, with frequent recourse to electric welding.

Here again it would be worth while to trace out the evolution of the different

types, but lack of time necessitates that reference should be confined to the crane represented in Figs. 17a and 17b, which is distinguished by its elegance

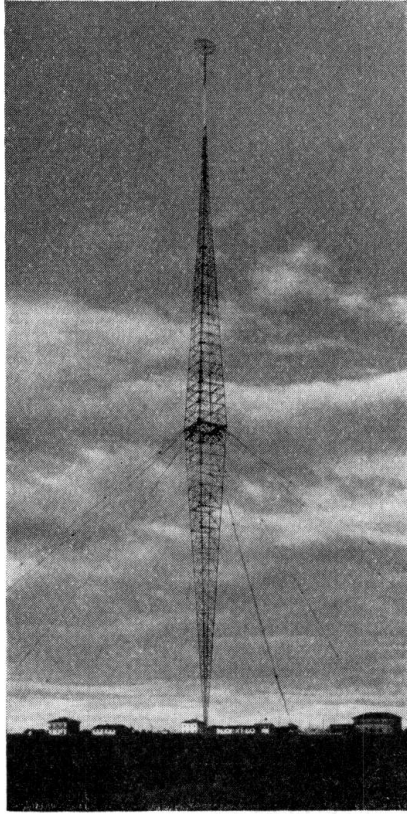

Fig. 16a.

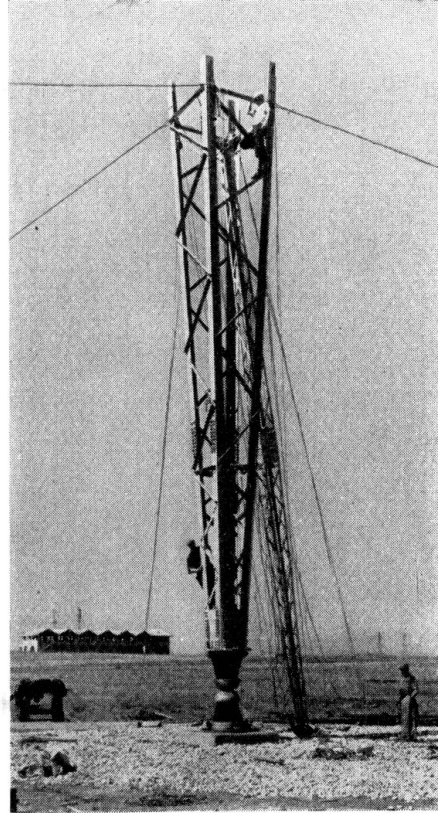

Fig. 16b.

of line and by the method of construction, entirely by welding. The vertical arm consists of two co-axial tubes; the inner tube is entirely welded and the

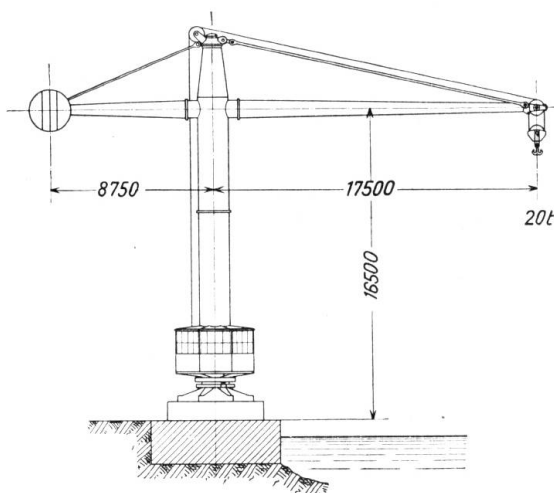

Fig. 17a.

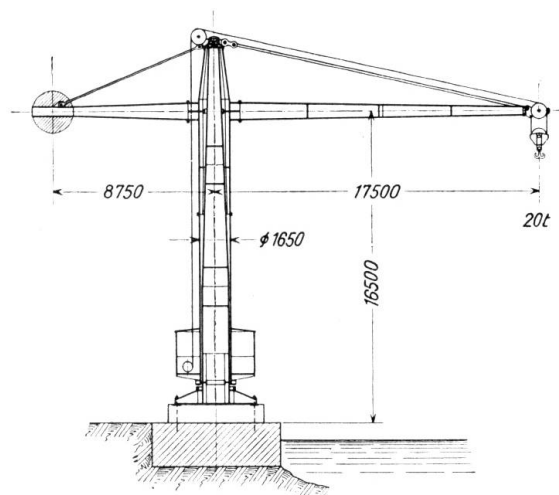

Fig. 17b.

outer one, for reasons of erection, is made in two parts connected by bolted flanges. The same form of connection is used between the two horizontal arms and the upper portion of the vertical member.

7) Finally reference may be made to some special structures made in weldless tubes of semi-hard steel, a form of work which has assumed a wide development

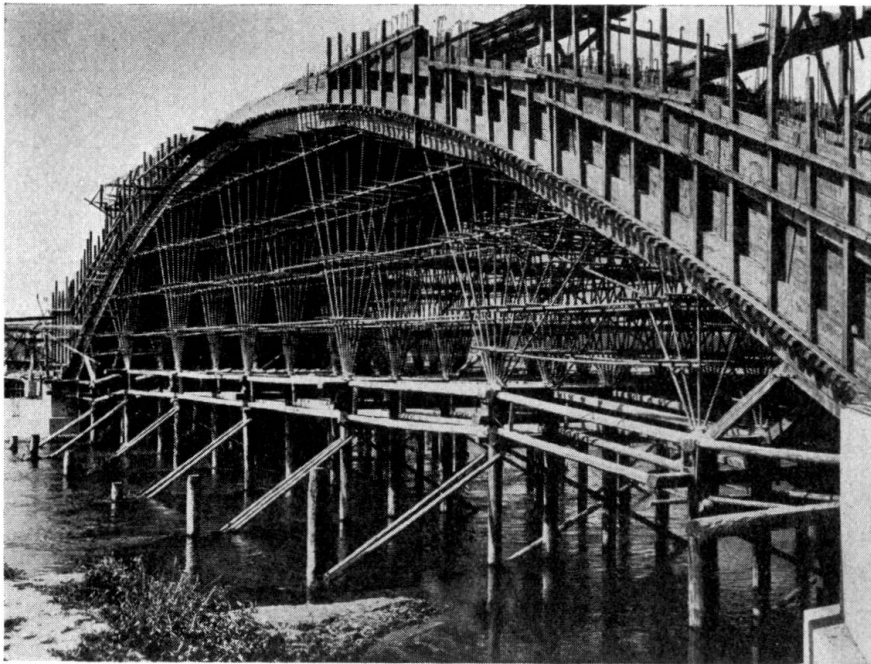

Fig. 18.

in Italy. Fig. 18 shows the centring for a concrete bridge over the river Ticino near Pavia. Fig. 19 shows the extensive falsework of the new bridge now in course of construction over the Tiber giving access to the Mussolini Stadium;

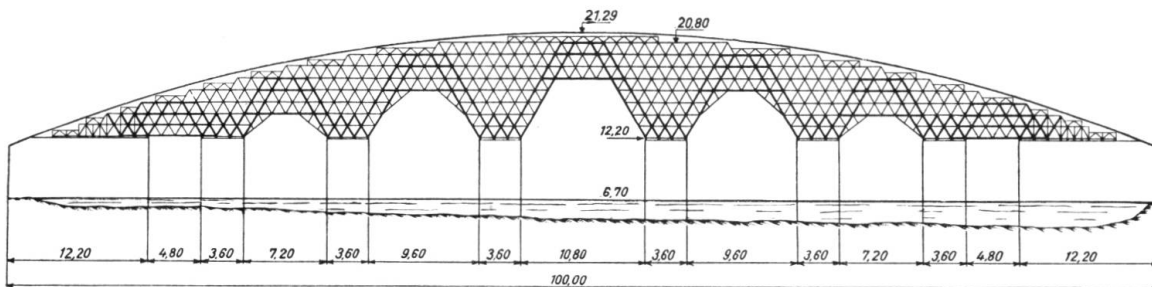

Fig. 19.

this will be a reinforced concrete bridge with a central arch of 100 m span. This centring involves the use of 64 000 m of tubing with 54 000 junction pieces.

VII a 4

Experiments on Girders with Welded Web Stiffeners.

Versuche mit Trägern, deren Stege durch angeschweißte Versteifungen verstärkt sind.

Essais sur poutrelles renforcées par des raidisseurs soudées à leur âme.

Dr. Ing. St. Bryła,

Professeur à l'Ecole Polytechnique de Varsovie (Pologne).

A series of tests was carried out to study the effect of stiffeners welded to the webs of joists, in the first place on sixteen joists PN 16, 20, 24 and 30 and secondly on six joists, PN 32 and 34, all the joists having a span of $L = 2$ m and being bent by the application of a concentrated load at the middle of the span.

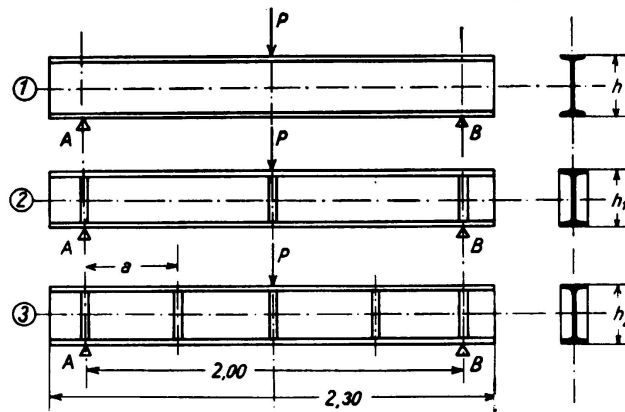

Fig. 1—3.

The joists tested were of three types.

- 1) Joists without stiffeners on the webs (Fig. 1).
- 2) Joists having three pairs of stiffeners arranged respectively over the supports and below the concentrated load (Fig. 2).
- 3) Joists fitted with five pairs of stiffeners at 0.50 m centres (Fig. 3).

Table I shows maximum values of the forces which caused failure of the joists, the suffixes denoting the numbers of pairs of stiffeners.

Table I.

NP	breaking load		
	R ₀	R ₃	R ₅
16	8.6 t	7.425 t	7.6 t
20	15.4	13.75	15.8
24	22.9	23.85	26.3
30	39.9	48.45	48.3
32	46.0	58.5	59.5
34	51.0	69.5	72.5

A study of the differences $R_3 - R_0$ as given in Table II shows that in the case of relatively deep joists the addition of three pairs of stiffeners increases the breaking load R in proportion to the depth of the joist. In the case of joists PN 16 and 20 no additional strength was obtained by the addition of stiffeners. The last column of the table gives the increase in strength brought about by the addition of five pairs of stiffeners: but in the case of joists PN 16 the strength was thereby reduced, while in the case of the other joists the increase in strength is proportionate to the height of the joist in question.

Table II.

NP	R ₃ —R ₀		R ₅ —R ₃		R ₅ —R ₀	
	tonnes	%	tonnes	%	tonnes	%
16	— 1.175	— 13.7	0.175	2.36	— 1.0	— 11.6
20	— 1.75	— 11.3	2.05	14.9	0.4	2.6
24	0.95	4.15	2.45	10.27	3.4	14.8
30	8.55	21.4	0.15	— 0.31	8.4	21.0
32	12.5	27.2	1.0	1.71	13.5	29.4
34	18.5	36.3	3.0	4.6	21.5	42.2

Here the safe load (with $\sigma = 1200 \text{ kg/cm}^2$ and $M = \frac{PL}{4}$, L being 200 cm) is

$$P_b = \frac{4 \cdot 1200}{L} W = 24 W. \quad (1)$$

The factor of safety $n = \frac{R}{P_b}$, or ratio between the breaking load and the safe load, is given in Table III for each of the cases examined.

Table III.

I NP	W cm ³	P _b tonnes	n ₀	n ₃	n ₅
16	117	2.81	3.06	2.98	3.05
20	214	5.14	3	2.68	3.08
24	354	8.50	2.7	2.80	3.10
30	653	15.67	2.55	3.09	3.08
32	782	18.75	2.45	3.12	3.16
34	923	22.32	2.28	3.12	3.25

If joists PN 16 and 20 are left out of account it will be seen that n_0 becomes less and n_3 becomes greater in proportion as the depth of the joist increases, while n_5 scarcely varies at all, but is always greater than n_0 .

Table IV gives the values of σ obtained by substituting for P the values of Q and R given in Table I and taking for W the values listed in Table III. In this way the results obtained from joists of varying depth are brought to a common measure.

Table IV.

I NP	Number of pairs of stiffeners	Stresses σ obtained by substituting the values of Q and R from Table I for those of P in equation (3)	
		Q	R
16	0	29.5	36.8
	3	29	31.7
	5	29	32.4
20	0	29.2	36
	3	27.9	32.2
	5	31	36.9
24	0	26.2	32.4
	3	27.4	33.8
	5	29.7	37.2
30	0	23	30.6
	3	29.3	37
	5	30.2	37
32	0	—	29.4
	3	—	37.4
	5	—	38.0
34	0	—	27.7
	3	—	37.7
	5	—	39.3

The diagrams in Figs. 4 and 6 are a graphical representation of the results stated in Table IV, the abscissae denoting the heights of the joists in centimetres and the ordinates denoting the stresses σ in kg/mm². Had the material of the joist been perfectly homogeneous and the tests been carried out under ideal conditions without any possibility of lateral buckling, and had the formula $\sigma = \frac{M}{W}$ been valid up to the point of failure, the curves would have been horizontal lines.

It will be noted that curve 4 drops while curves 5 and 6 are rising. The first mentioned result was to be expected, and the latter indicates that this loss of strength can be avoided by welding stiffeners on to the webs and flanges of the joists, the phenomenon being due to the collapse of the upper flange.

Figs. 7 and 8 show the manner and magnitude of the effect. Those joists which are provided with stiffeners assume after failure a double undulation

with the points of inflection at the centre of the joists (Fig. 7), whereas the joists unprovided with stiffeners (Fig. 8) assume after failure a shape containing only a single undulation; the effect of the stiffeners is, therefore, to promote the double undulation with the consequence that the critical buckling load is increased.

The phenomenon was the same in all the joists. In those with stiffeners both flanges became bent, the upper flange as much as the lower, but the joists without stiffeners remained straight with only a limited amount of deflection. In the joists without stiffeners a crushing of the upper flange underneath the concentrated load was observed and this effect increased with the depth of

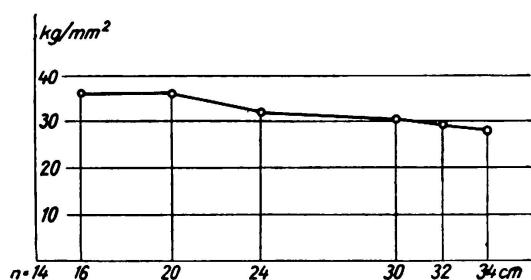

Fig. 4.

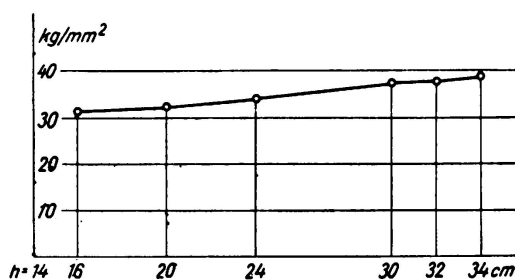

Fig. 5.

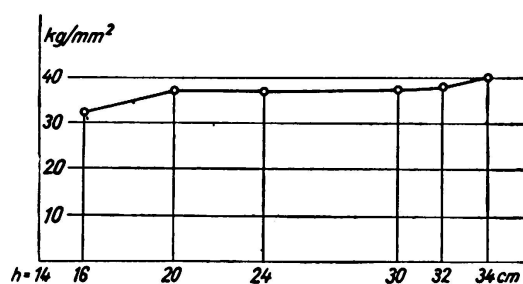

Fig. 6.

the joist. The influence of the stiffeners on the deformation of the joist becomes more marked in proportion to their depth. It follows that the resistance of the joists to bending where stiffeners were provided was on the point of being used up, and that fracture was imminent. On the other hand in the joists which had no stiffeners failure due to bending was still a long way off, and failure actually occurred on account of the buckling of the flange under the concentrated load. The collapse observed in the deep joists without stiffeners when the stresses σ were still relatively low appears to indicate that it is not these stresses which play the predominant role, but rather the normal stresses present in the horizontal section of the web immediately below the flange underneath the concentrated load, to which Professor *Huber* has given the name of transverse stresses, and has devoted several chapters of his book.¹ The present author will give a more detailed study of these transverse stresses elsewhere, and will here merely summarise the results.

¹ *M. T. Huber: Investigations of I-beams double T. Proceedings of the Technical Society of Warsaw, 1925.*

1) The reinforcing of an I-joist by means of stiffeners welded to the web below the concentrated load has the effect of increasing its resistance to bending, the increase being more marked in proportion to the depth of the joist, and

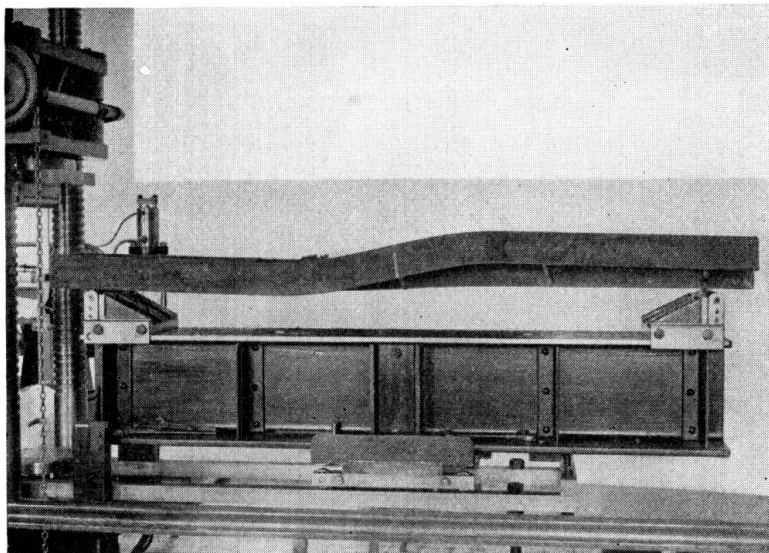

Fig. 7.

being inappreciable in a joist PN 16 but amounting to 40 % in the case of a joist PN 30. The provision of stiffeners welded to the web at other points than the concentrated load also increases the resistance of the joist, though to a smaller extent.

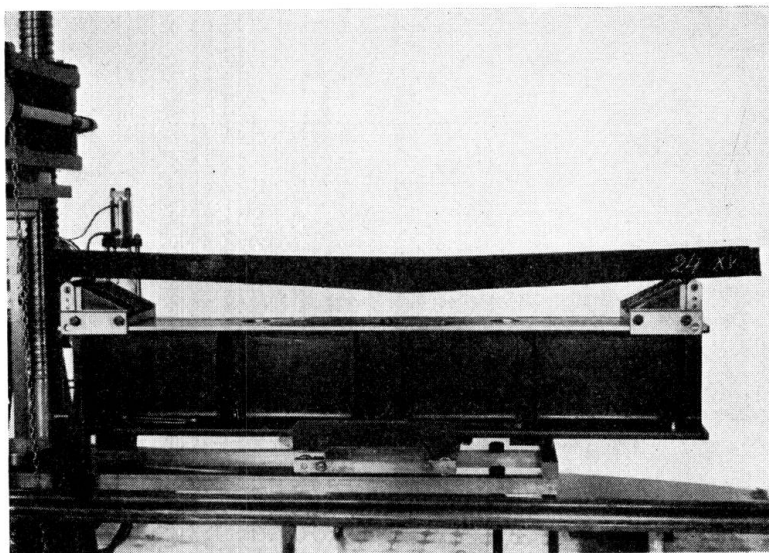

Fig. 8.

2) The maximum stresses calculated from the formula $\sigma = \frac{M}{W}$ must be reduced in the case of very deep joists. This formula cannot be used to determine the strength of joists in excess of a certain depth when subjected to concentrated loads, as such joists fail not by bending but by crushing of the flange where the load is applied. By welding on stiffeners underneath the concentrated load the failure by buckling is delayed and the formula as given may continue to be used.

VIIa 5

Illuminating and Constructional Considerations in the Arrangement of Long Span Saw-Tooth Roofs with Steel Frames.¹

Lichttechnische und konstruktive Gesichtspunkte für die Anordnung weitgespannter Sägedächer mit Traggerippe aus Baustahl.¹

Les points de vue de l'éclairage et de la construction dans la disposition des sheds de grande portée avec fermes métalliques.¹

Dr. Ing. H. Maier-Leibnitz,
Professor an der Technischen Hochschule, Stuttgart.

I. In the case of industrial single storey buildings which form the simplest special case of multiple bay sheds, the structural features are primarily influenced by the character of the daylighting, ventilation, rainwater, drainage, crane equipment and the placing of the supports as governed by operating conditions. A further condition is imposed on the design in that impressive and aesthetically satisfactory interiors as well as exteriors are to be realised.

II. As regards the arrangement of *daylight openings* in an industrial single storey building, there are a surprisingly large number of possibilities which have been tried in practice, but these vary greatly in their merits from the point of view of illumination. Ordinary skylights (see fig. 1, whether with inclined or vertical glass surfaces (Boileau roofs), result in intensities of lighting which are not uniform, and which, in their maximum values, tend to be excessive. At any time during the day, whatever may be the position of the daylight openings, sunbeams may enter. During the summer this is bound to give rise to uncomfortable greenhouse conditions of temperature in the building, and will at any time of the year tend to dazzle the workers, apart from which, in many cases, the sun's rays are undesirable for the sake of the product under manufacture.

All these disadvantages can be avoided by the adoption of *saw-tooth roofs*, which guarantee a quality of lighting in the workshop equal to that in an artist's studio, and do this under economically reasonable terms.

To assess the quality and uniformity of the daylighting use is made of the concept of the daylight ratio TQ. (*Tageslichtquotient*), which is defined as the ratio of the intensity of the illumination existing on, for instance, a horizontal

¹ Supplement to the report VIIa 9 in the Preliminary Publication: Development of structural steel-work.

element of surface within the room, to the intensity of illumination on a horizontal element of surface under the open sky.²

Fig. 1 shows the T.Q. curve for a recently completed factory building having gable skylights, which illustrates the disadvantages explained above; nor can these be overcome by the usual expedient of coating the glass surfaces exposed to the sun with whitewash or the like.

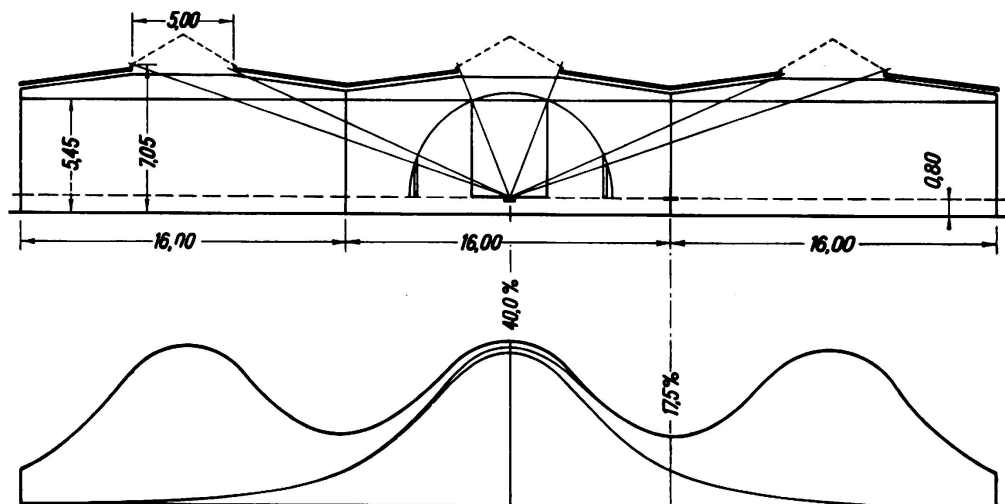

Fig. 1.

T.Q. line for saddle-shaped skylight.

It will be explained below that when a saw-tooth roof is adopted, the choice of the pitch of the transparent and non-transparent roof coverings, as well as the width of the glass surfaces, depends to a great extent on daylighting considerations. Fig. 2 shows a comparison between the following two cases, assuming a saw-tooth unit 7 m wide:

- a) Non-transparent roof covering inclined at 30° .
Transparent roof covering inclined at 60° .
- b) Non-transparent roof covering inclined at 30° .
Transparent roof covering vertical.

The T.Q. lines indicate that in case a) considerably better conditions are obtained than in case b). The T.Q. for the "characteristic" horizontal element — a concept which is also used below — in the middle of the second saw-tooth unit, amounts to 16.7% in case a) and to 12.3% in case b).

Fig. 3 shows how the saw-tooth units should be arranged with vertical glass surfaces in case c), so that the "characteristic" element of area already mentioned will have a T.Q. of equal value to that obtained in case a). The considerably greater amount of both transparent and non-transparent roof covering required in case c) as compared with case a) will be noticed. In the effect of illumination nothing is altered if, with a view to economy in case c), the transparent roof

² See *Maier-Leibnitz: Der Industriebau, die bauliche Gestaltung von Gesamtanlagen und Einzelgebäuden*, Berlin, 1932, p. 74 ff.; also DIN Sheet 5034. In the experiments on illumination described below very long strips of glass are assumed. The very simple construction for T. Q. may be seen from the illustrations.

covering is carried out from the upper edge of the gutter at right angles to the non-transparent covering, so that the non-transparent roof forms a kind of overhang. Such types of saw-tooth roofs would be specially useful, for instance, in the neighbourhood of the Equator where it is desired to prevent the entrance of very steeply incident rays of the sun into the room.

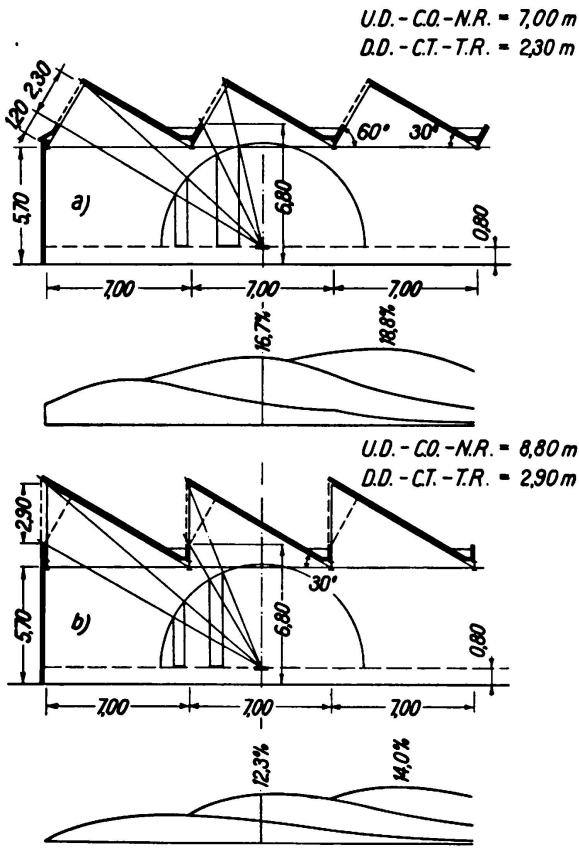

Fig. 2.

Saw-tooth roofs, 7 m — units.

T.Q.-lines for horizontal elements.

- a) T.R. = Transparent roof covering inclined at 60°.
- N.R. = Non-transparent roof covering inclined at 30°.
- b) T.R. = Transparent roof covering vertical.
- N.R. = Non-transparent roof covering inclined at 30°.

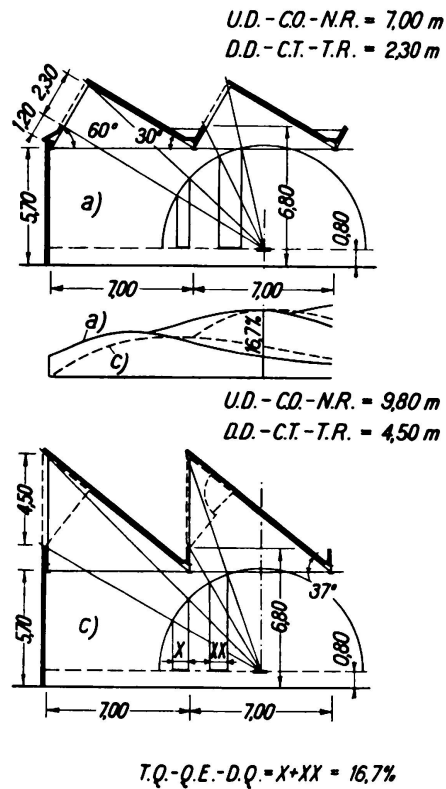

Fig. 3.

Saw-tooth roofs, 7 m — units.

T.Q.-lines for horizontal elements.

- a) T.R. = Transparent roof covering inclined at 60°.
- N.R. = Non-transparent roof covering inclined at 30°.
- c) T.R. = Transparent roof covering vertical.
- N.R. = Non-transparent roof covering inclined at 37°.

Fig. 4 gives the TQ. curve for case a₁); which is fundamentally similar to case a) except that the non-transparent portion of the roof covering has an overhang which extends to a point lying vertically above the lowest point of the glass strip. In the "characteristic" horizontal element of the second saw-tooth unit there is obtained a TQ. value of 12.3 %, equal to that for case b), whereas in case a) the value is 16.7 %. In case d) it is shown to what width the strip of glass has to be reduced (1.7 m instead of 2.30 m) in order that the characteristic element may receive the same TQ. as in case a₁). If, in case d), the upper

portion of the non-transparent roof covering is made movable, a certain "dosage" of daylight may be obtained, and just as in case a_1) the entry of sunbeams into the room may effectively be prevented under even unfavourable conditions, such as the height of summer.

Without detriment to the T.Q. value further savings in the transparent and non-transparent roof coverings might be effected by reducing the pitch of the transparent covering to, for instance, 45° .

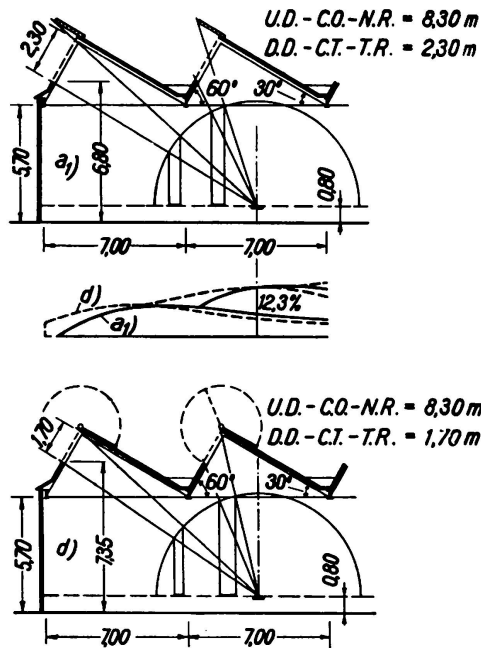

Fig. 4.

Saw-tooth roofs, 7 m — units.

T.Q.-lines for horizontal elements.

- a_1) T.R. = Transparent roof covering inclined at 60° with cantilever.
 N.R. = Non-transparent roof covering inclined at 30° .
 d) T.R. = Transparent roof covering inclined at 60° .
 N.R. = Non-transparent roof covering inclined at 30° .

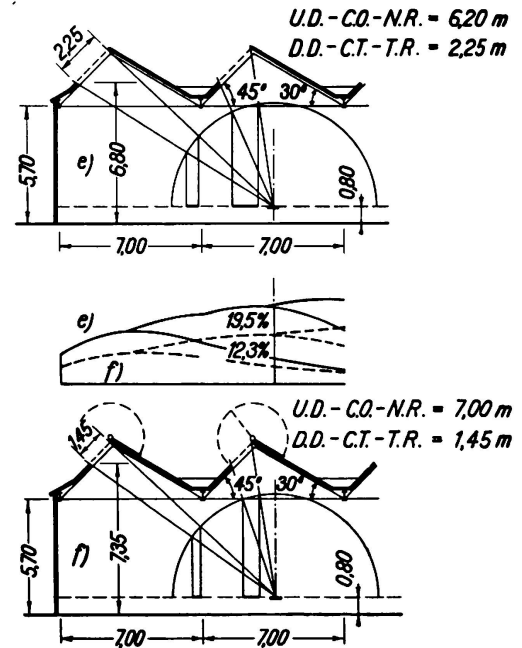

Fig. 5.

Saw tooth roofs, 7 m — units.

T.Q.-Lines for horizontal elements.

- e) T.R. = Transparent roof covering inclined at 45° .
 N.R. = Non-transparent roof covering inclined at 30° .
 Level of gutter same as for cases a — d incl.
 f) T.R. = Transparent roof covering inclined at 45° .
 N.R. = Non-transparent roof covering inclined at 30° .

Fig. 5 shows two such cases. In case e) the same conditions are chosen as in cases a) and a_1), both as regards the gutters and their top edges. At the "characteristic" point the T.Q. value is 19.5 %.

In case f) the strips of glass are only 1.45 m wide, but in spite of this there is obtained at the "characteristic" element the same T.Q. value of 12.3 % as in cases a_1), b) and d), the inclination of 30 % for the non-transparent roof covering being retained. In both cases e) and f) it is assumed that movable parts for dosing the daylight are fitted. Case f) approximates to the desired minimum of building and operating cost.

For cases a) and b) the T.Q. curves of the vertical elements of area are shown in Fig. 6.

III. As regards constructional considerations affecting the *rainage and ventilation of saw-tooth roofs*, the criticism that saw-tooth roofs are difficult to venti-

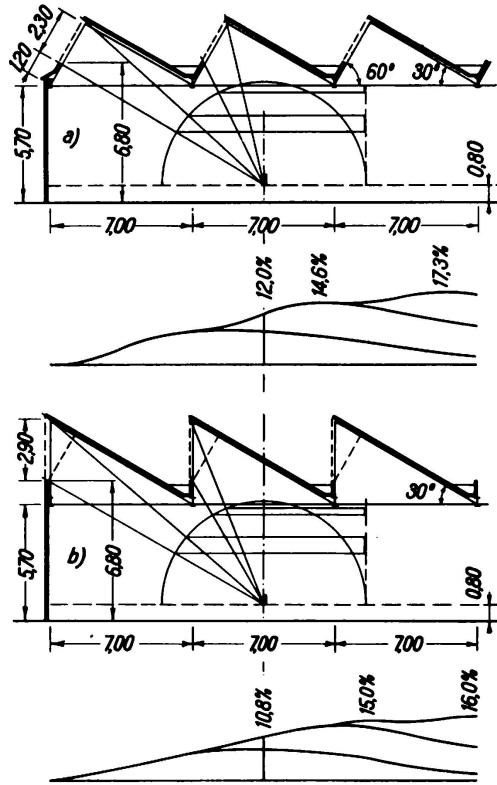

Fig. 6.

Saw-tooth roofs, 7 m — units.
T.Q.-lines for vertical elements.

- a) T.R. = Transparent roof covering inclined at 60°.
- N.R. = Non-transparent roof covering inclined at 30°.
- b) T.R. = Transparent roof covering vertical.
- N.R. = Non-transparent roof covering inclined at 30°.

late is overcome by the provision of ventilating flaps, as shown in Fig. 3 for case c) or by the provision of suitably arranged ventilators of cylindrical profile on the ridge of the saw-tooth roof. This ensures at least as good ventilation as is

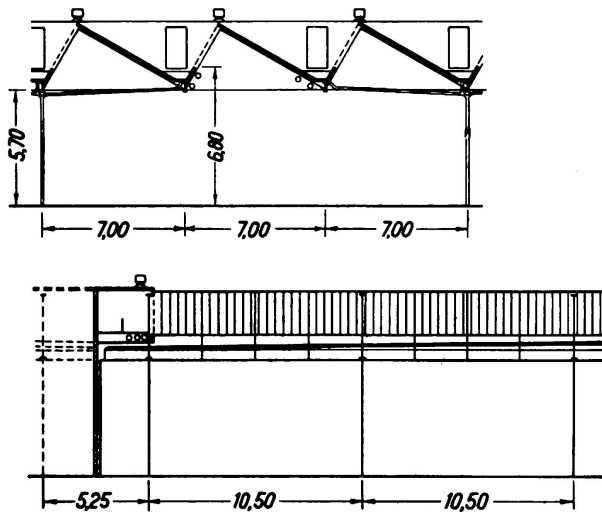

Fig. 7.

Inspection gangway on the east and west side of a building.

possible with gable skylights. Ventilation may be considerably simplified if, as shown in Fig. 7, an inspection gangway is provided either on the east or

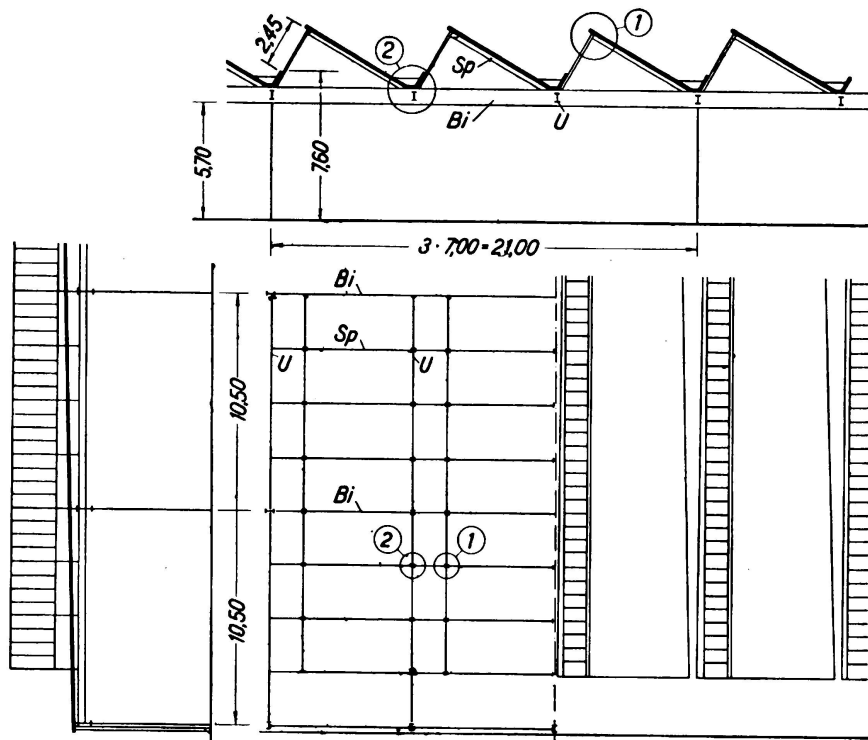

Fig. 8.

Case A: Supporting rib for bays of $21 \times 10,5$ m, plate webbed main girder running north and south.

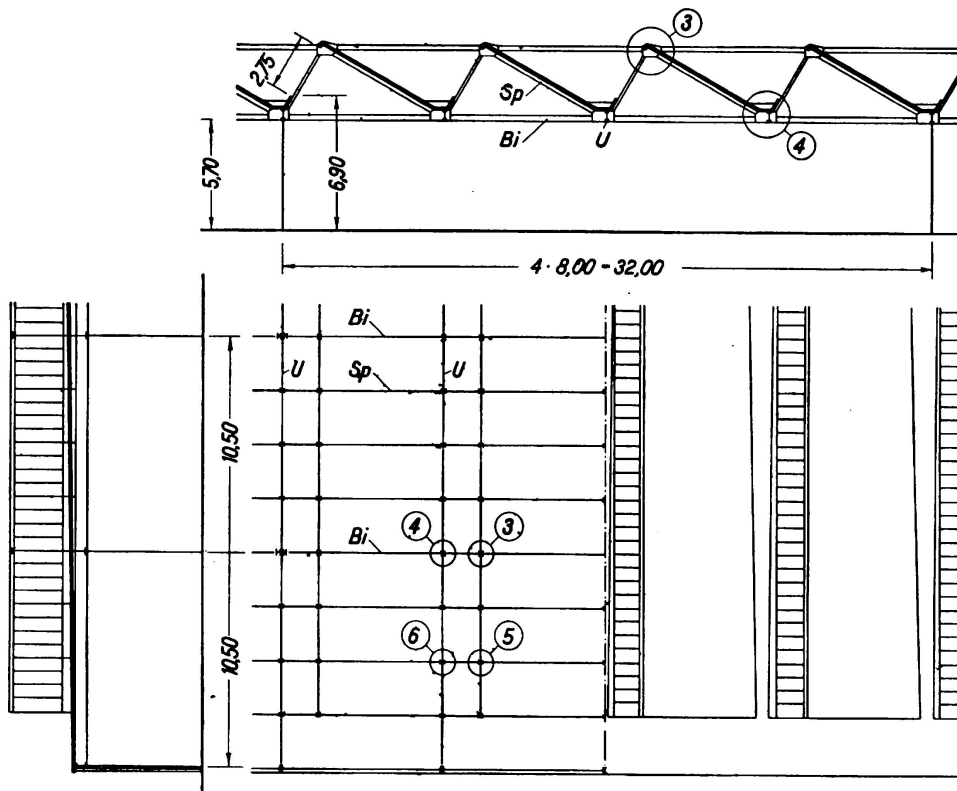

Fig. 9.

Case B: Carrying ribs for bays of $32 \times 10,5$ m, main girder of open frame construction running north and south.

the west side of the saw-tooth roof. Such a gangway also brings the gutters in the valleys between the saw-teeth within easy reach. The inner spaces below the saw-tooth roof are connected, for the purpose of ventilation, by a transverse

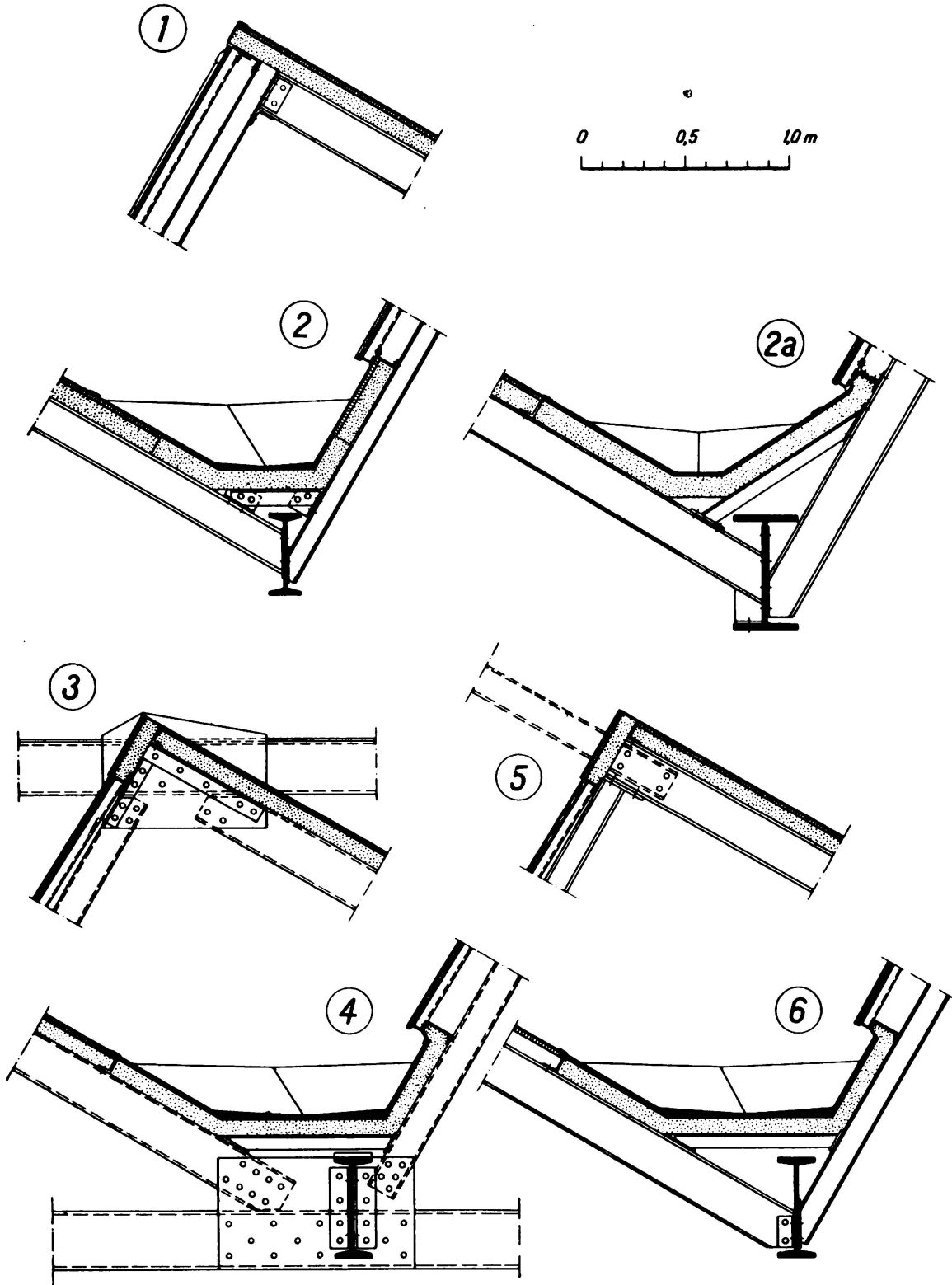

Fig. 10.

Details of the carrying ribs and arrangement of the roof covering for Figs. 8 and 9.

duct. On the transparent floor of the inspection gangway pipe lines can be laid running along the length of the building, and can easily be introduced into the spaces below the saw-tooth roof. The external design of a single storey building is greatly facilitated by the provision of an inspection gangway of this kind, and the objection that may be raised against saw-tooth roofs that they are ugly is in this way overcome.

IV. Among the different possibilities of arranging the *supporting frames of long span saw-tooth roofs*, reference will be made here only to that form in which the most important of the structural elements, namely, the main roof

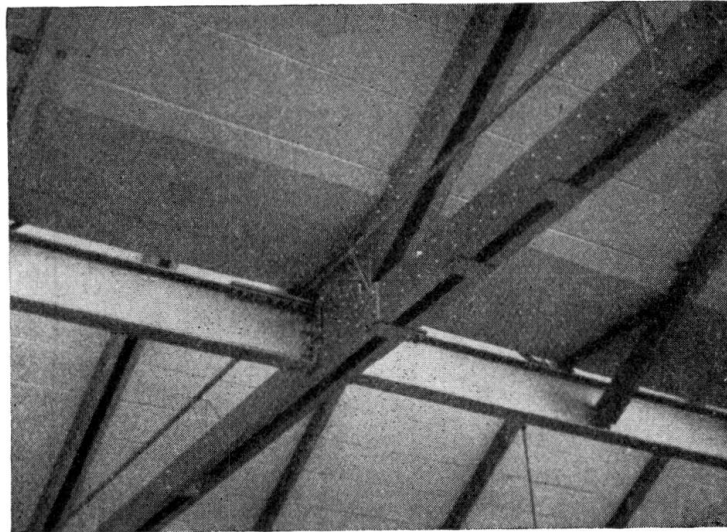

Fig. 11.

Intersection point in the lower boom of a main girder in the framing system.

trusses, run north and south, i. e. the greatest spans between the stancheons are demanded in this direction. Here two cases are to be distinguished:

Case A: In Fig. 8 the spacings of the supports are at 21 by 10.5 m. The steel skeleton consists mainly of continuous plate girders (H. Bi) together with purlins (U) spanning 10.5 m, and rafters (SP) to which the non-transparent roof covering, in the form of pumice concrete slabs, is directly attached. The spaces under the saw-tooth roof are completely free from constructional members between the main girders.

Case B: Here use is made of continuous trusses of 32 m span and the purlins are so connected as to ensure their operation as continuous beams.

The details most essential to this design are shown in Fig. 10 for both cases. In the building indicated in the sketch 2a the continuous purlins are arranged over spans of $10 + 19.5 + 19.5 + 10$ m.

Fig. 11 shows a point of junction in the bottom chord of the trusses and the above mentioned connection of the purlins with a truss. There also are to be seen the lower inclined surfaces of the gutters. Enough space is left between the lower part of the gutter and the purlin to allow of running pipe lines from one saw-tooth unit to another.

VIIa 6

Observations on the Design of New Belgian Vierendeel Bridges of Wide Span.

Betrachtungen über Vierendeel-Brücken großer Spannweite,
die vor kurzem in Belgien gebaut wurden.

Considérations sur l'étude de quelques ponts Vierendeel de grande portée construits récemment en Belgique.

R. Desprets,

Professeur à l'Université de Bruxelles.

The Vierendeel girder has been adopted for many road and railway bridges. The most important of its applications under standard gauge railway lines are those recently carried out on the Belgian State Railways at Hérenthals over the Albert canal and at Malines, in connection with the electrification of the Brussels-Antwerp line. These works were completed in 1934 and are now in operation.

I. General description.

Hérenthals Bridges (Fig. 1).

The Hérenthals bridges form two series, respectively with double and single tracks, making three spans separated by concrete piers. In view of the considerable skewness of the crossing of the railway in relation to the axis of the canal, and to the desirability of using normal type of supports for the bridges, it was decided to adopt spans of approximately 90 m for the central opening and of 33 m for each of the side openings. It was also deemed expedient to adopt independent bridges carried on simple supports under each of the spans. The central openings are crossed by two straight bridges having their main girders of the Vierendeel type, the side spans by deck bridges with plate webbed girders under the track.

In order to limit the maximum width of the intermediate piers only movable bearings were provided on these, an arrangement which was only rendered possible by making the deck of the central span monolithic with those of the side spans in order to carry all of the longitudinal reactions onto the end abutments.

Malines Bridges (Fig. 2).

The two bridges at Malines were constructed one with a span of approximately 53.50 m over the Louvain canal, and the other with a span of about 90 m over

the Malines-Louvain highway. These structures are in the electrified line between Brussels and Antwerp. They are of single span for double track. The main girders are of the Vierendeel type, those for 90 m span being similar to the corresponding bridge at Hérenthals.

II. Main Vierendeel Girders.

The Vierendeel girders for the Hérenthals and Malines bridges consist essentially of a parabolic arch with a rise of $\frac{1}{7}$ divided into eleven panels. Both were designed by reference to the same numerical tables. All the members of

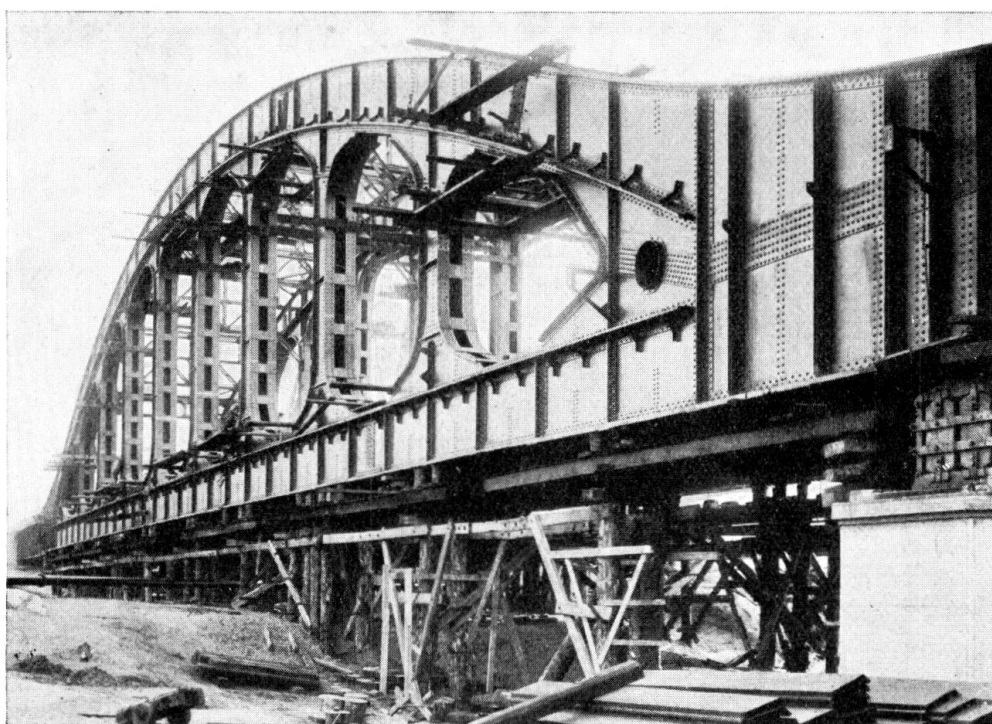

Fig. 1.

Railway bridge with Vierendeel main girders: movable bearing.

these girders are box shaped in section and are made sufficiently large to allow access to a workman for purposes of maintenance. In view of the necessity to take up bending moments in either direction the cross sections are double T; they are built up in the usual way from web plates, angles and flats. In the case of the 90 m bridge girders for the double track it was necessary to make use of special angle sections with legs 180 mm wide. As in ordinary box sections for lattice girders, cover plates have been provided only on the outside of the box, but in view of their width they are inserted between the two angles attached to the web plates and the free end is butted against the web to eliminate any tendency to bulging of the angle legs.

The verticals are, of course, run through the boxes which form the arch and the lower boom, thus making an exceptionally rigid framework. The erection joints for the verticals are made near the ends of the curved portions top and bottom and their exact position is fixed by the effective maximum width of the

gusset plate. The web of the vertical is made continuous through-out the depth of the girder. It should be remarked that the arch sections and the tie sections are continuous from end to end of the girder, an arrangement which is justified if the whole is regarded as acting like a simple bowstring girder under a continuous uniform load.

The box bracing, interior diaphragms and cross bracings were subjected to very close study in detailing, in order to ensure the greatest possible rigidity without wastage.

The girder ends connecting the arch with the tie called for particularly careful investigation in view of the large sizes of plate to be used; it was necessary

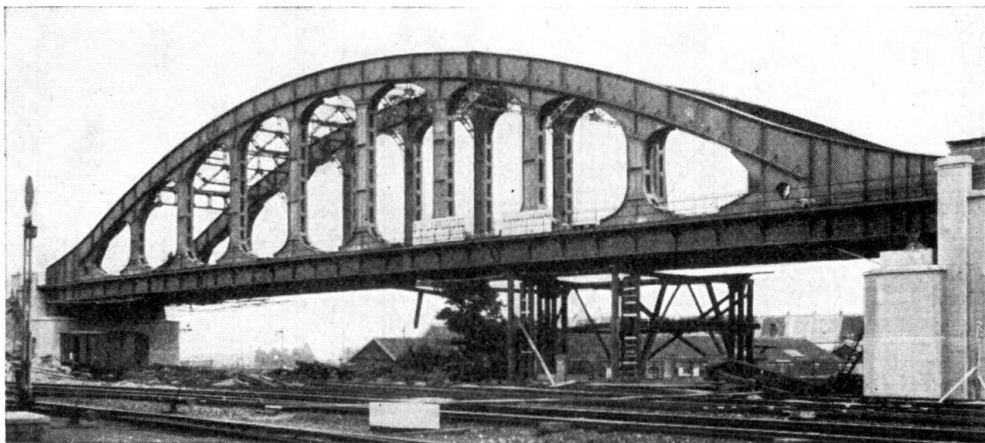

Fig. 2.

Railway bridge over the Louvain road at Malines. Elevation.

to limit the number of joints and provide a sufficient number of stiffeners, while at the same time allowing access for maintenance if required. The principle adopted is the provision of a horizontal diaphragm at an intermediate level with a series of vertical diaphragms pierced by manholes allowing access to any of the internal spaces.

Calculations.

The characteristic of the Vierendeel girder with simple verticals is the absence of any diagonal members and the consequent elimination, according to its inventor, of those secondary stresses which are so harmful in lattice girders on account of the increase in total stress which they may entail and cause to be excessive. Without again entering upon the vigorous controversy on this subject which has been maintained from time to time it may be permissible to observe that frequently what are described as secondary stresses are merely primary stresses, the term being extended to include stresses due to eccentricities of connection which admit of precise calculation and which are the result of forces acting in the ordinary way. It would be better to reserve the term "secondary stresses" to stresses caused by deformation, such as tend to arise in a lattice system on account of the angular deformations due to extension and contraction of the bars.

It is obvious that if the deformability of the intersection points is increased to an extent which makes these approximate to pin joints such stresses will disappear, and the English expression "self relieving stresses" may properly be applied to them. This result may be attained through the play of the rivets or through the plasticity inherent in the gussets and in the bars. Such stresses, thus defined, play a minor part by comparison with that sometimes attributed to them. It should be added that all structures which deform more or less are exposed to these stresses, within limits that vary according to the degree of restraint imposed upon the free interplay of forces by the rigidity of the component elements. In a lattice girder, for instance, calculations and experiments agree in indicating that these stresses are practically proportional to the inertia per unit length $\left(\frac{I}{l}\right)$ of the element.

The present girders were designed in accordance with the simplified method explained by M. Vierendeel in his course on the stability of structures. From the tables of diagrams in this work the values of the shear forces at the points of intersection of the verticals and those of the bending moments in the booms and in the verticals were read off for each loaded panel point, these elements of calculation being applicable directly to all girders of the same ratio between rise and span and the same number of panels. When the girder is under uniformly distributed load covering the whole span the force in the arch becomes a simple compression along its axis and the tie bar is uniformly stressed in tension between its supports, while the verticals are in simple tension from the weight of the floor.

It is of interest to note that in the prismatic central portions of the boom the stresses calculated on the hypothesis of a live load over the whole span are greater than those which result from partial loading. The latter condition would be less favourable only in the case of curved connections between the verticals and the booms on the assumption that these are of prismatic section. On the other hand the design of the verticals is conditioned by bending stresses when the bridge is partially loaded.

If the bending moment diagram for a panel length of the boom is examined, this diagram having been plotted on the usual hypothesis of constant cross section over the whole length of the panel, it will be seen that for certain conditions of loading the point of zero bending moment may be either within the width of the vertical member or within the covered portion of the connections. Having regard to the great increase in section as between the verticals and the booms, and to the wide extent of these transitions, it seems unlikely that these points of zero bending moment (coinciding with the points of inflection) will be displaced much outside the prismatic central portions of the booms. At any rate it may be inferred that the initial assumption of a constant moment of inertia will lead to conclusions that must be accepted with caution proportionate to the extent of the transition in comparison with the prismatic portions of the verticals and the booms. The limiting case would be reached in a girder consisting of a succession of triangles touching one another at the central points of the booms and verticals. It is, therefore, difficult to ascribe any great accuracy to a method of calculation for a Vierendeel girder which does not take account of the variations

of the moments of inertia due to the transitions, and it would appear that a simpler method of fixing the point of inflection in the prismatic portions of the booms *a priori* would give satisfactory results not necessarily more erroneous than are obtained by the method alleged to possess greater accuracy. Such a method has been devised by the German engineer Engesser and described by him in the *Zeitschrift für Bauwesen* in 1913. Engesser assumes that the verticals possess infinite rigidity, and he deduces from this that the points of inflection on the booms would be situated on the vertical line passing through the centre of gravity of each panel of the girder.

The fixing of fictitious hinges is immediately accomplished, and allows of a simple and rapid calculation of the different isostatic sections of the girder.

Relative calculations carried out to determine the stresses in a girder of about 100 m span for a railway bridge, single track, using the two methods of Vierendeel and Engesser respectively, indicate that the approximate method gives satisfactory results. It is only right to mention that before Engesser, M. Vierendeel himself had pointed out a similar simplification applicable to girders with parallel booms.

It should be noticed that the ratio of the linear moments of inertia (ratios of moments of inertia to length) in the elements of the boom, to the corresponding figure for the verticals, is of basic importance in defining the action of a Vierendeel girder. The limiting conclusions can easily be ascertained by making use of the general relationship given below (due to *Keelhoff* in his "Cours de Stabilité"):

$$\frac{(I'c)^3 + I''^3}{(I'c + I'')^3} \left[H_n^3 \frac{Z_n}{I_n} - H_{n-1}^3 \frac{Z_{n-1}}{I_{n-1}} \right] = \frac{3\lambda}{2} \frac{H_{n-1} + H_n}{I'c + I''} (M'_n + M''_n)$$

Here a single panel of the girder is considered, with the heights of the verticals given by H_{n-1} , H_n and the moments of inertia by I_{n-1} and I_n . The normal width of a panel is λ , the moments of inertia of the upper and lower booms are assumed to be constant at I' and I'' . The upper boom forms an angle φ with the horizontal for which $\cos \varphi = c$, and the lower boom is itself horizontal. If a section is taken through a panel along a vertical line passing through the centre of gravity, the bending moments in the upper and lower booms respectively are M'_n and M''_n , while Z_{n-1} and Z_n are the horizontal shear forces acting at the points of contraflexure of the verticals.

Recalling the fundamental hypotheses,

$$\frac{M'}{M''} = \frac{I'c}{I''} \quad \text{et} \quad \frac{h'}{h''} = \frac{I'c}{I''}$$

h' and h'' fix the position of the point of inflection in a vertical.

To disclose more easily the limiting conditions we will suppose that $I' = I'' = I$

$\frac{I}{\lambda} = \beta$ is the linear inertia of the lower boom,

$\frac{I_n}{H_n} = \frac{I_{n-1}}{H_{n-1}} = \alpha$ is the linear inertia of the verticals

$$\frac{1 + c^3}{(1 + c)^2} = K.$$

The general relationship takes the following form

$$H_n^2 \cdot Z_n - H_{n-1}^2 \cdot Z_{n-1} = \frac{\alpha}{\beta} \cdot \frac{1}{K} \cdot \frac{3}{2} (H_{n-1} + H_n) (M'_n + M''_n)$$

wherein the ratio $\frac{\alpha}{\beta}$ between the linear inertia of the verticals and the booms appears as a principal coefficient.

The limiting values of $\frac{\alpha}{\beta}$ are ∞ and 0, the value $\frac{\alpha}{\beta} = \infty$ or, reciprocally, $\frac{\beta}{\alpha} = 0$ corresponding to Engesser's assumption that the moment of inertia of the verticals is infinity. Applying $\frac{\beta}{\alpha}$ to the first member, the hypothesis $\frac{\beta}{\alpha} = 0$ implies M'_n and $M''_n = 0$ and since M' and M'' are of the same sign, $M'_n = 0$ and $M''_n = 0$.

We may infer that the sections of the booms on a vertical line passing through the centre of gravity of the panel are the sections of zero bending moments, whatever the loading. If nothing but the simple bending of the booms is considered, these sections will correspond to points of inflection. In the case of a girder of constant height these points will be situated at the centre of each panel.

The other limiting value $\frac{\beta}{\alpha} = 0$ corresponds to the case where the verticals possess zero inertia, as is practically the case in bowstring girders with thin suspension bars, and as would also be true of two parallel booms of equal inertia connected by vertical pin-jointed rods.

$$\begin{aligned} H_n^2 \cdot Z_n &= H_{n-1}^2 \cdot Z_{n-1} \\ Z_{n-1} &= Z_n \cdot \frac{H_n^2}{H_{n-1}^2} \end{aligned}$$

Z_{n-1} has the same sign as Z_n the proportion being that of the squares of the height of the verticals.

Under the hypothesis of vertical loads $\Sigma Z = 0$.

In the case of a girder with parallel booms $\Sigma Z = 0$ which may be written

$$Z_n \cdot H_n^2 \cdot \sum_0^m \frac{1}{H^2} = 0$$

and reduces to $Z_n = 0$. All the shear forces in the verticals are zero.

In the case of a bowstring girder with thin suspension bars the summation ΣZ_n includes a term

$$Z_0 = Z_n \cdot \frac{H_n^2}{H_0^2}$$

If $Z_n \geq 0$, H_0 being zero, Z_0 would be infinite.

Now, in this case the value of Z_0 is determined and finite, as it corresponds to the horizontal component of the axial thrust in the arch. For Z_0 to be finite while H_0 is zero it is necessary that Z_n should be zero, a conclusion which brings us back to the ordinary definition of a bowstring girder with thin vertical members pin-jointed to the arch and tensile boom.