

Zeitschrift: IABSE congress report = Rapport du congrès AIPC = IVBH
Kongressbericht

Band: 3 (1948)

Artikel: Derived moment-angle curves for web-cleat connections

Autor: Beaufoy, Leroy A. / Moharram, A.

DOI: <https://doi.org/10.5169/seals-4002>

Nutzungsbedingungen

Die ETH-Bibliothek ist die Anbieterin der digitalisierten Zeitschriften. Sie besitzt keine Urheberrechte an den Zeitschriften und ist nicht verantwortlich für deren Inhalte. Die Rechte liegen in der Regel bei den Herausgebern beziehungsweise den externen Rechteinhabern. [Siehe Rechtliche Hinweise.](#)

Conditions d'utilisation

L'ETH Library est le fournisseur des revues numérisées. Elle ne détient aucun droit d'auteur sur les revues et n'est pas responsable de leur contenu. En règle générale, les droits sont détenus par les éditeurs ou les détenteurs de droits externes. [Voir Informations légales.](#)

Terms of use

The ETH Library is the provider of the digitised journals. It does not own any copyrights to the journals and is not responsible for their content. The rights usually lie with the publishers or the external rights holders. [See Legal notice.](#)

Download PDF: 15.03.2025

ETH-Bibliothek Zürich, E-Periodica, <https://www.e-periodica.ch>

Ib

Courbes dérivées moments-angles pour les assemblages goussets-âmes

Abgeleitete Moment-Drehwinkel-Kurven für Verbindungen mit am Steg angebrachten Befestigungswinkeln

Derived moment-angle curves for web-cleat connections

LEROY A. BEAUFOY

Ph. D., M. Sc. (Eng.), A. M. I. C. E.,
M. I. Mech. E., Chartered Civil Engineer
University Reader in Civil Engineering,
University of London, at King's College

&

A. MOHARRAM

M. Sc. (Eng.), A. M. I. Struct. E.,
Chartered Structural Engineer
Department of Civil and Mechanical Engineering,
University of London, at King's College

Introduction

In the investigations on beam-to-stanchion connections which were carried out by Professor C. Batho ⁽¹⁾ curves of the relationship between applied moment and change of angle between the beam and the stanchion were plotted. From these curves, standard moment-angle curves to be used as a basis for design were drawn for flange-cleat connections only. No similar curves were obtained for web-cleat connections since insufficient systematic experimental information was available. Nevertheless, some information was obtained.

For the connections shown in fig. 1 the moment-angle curves given in fig. 2 were obtained. The results prove that in a beam-to-stanchion connection, if both flange and web cleats are used, a very rigid connection is obtained the total rigidity of which is greater than the sum of the two component rigidities. This may be seen from the comparison, shown in fig. 2, where curve A represents the moment-angle curve for web cleats only, curve B that for flange cleats only, curve C the algebraic sum of the ordinates of the two previous curves for the same θ , and curve D the experimental moment-angle curve for both the web and the flange cleats mentioned above. Table I, fig. 2, shows the increase in the moments in curve D over those in curve C, expressed as a percentage

⁽¹⁾ *Second and Final Reports of the Steel Structures Research Committee of the Department of Scientific and Industrial Research (H. M. S. O.), 1934 and 1936.*

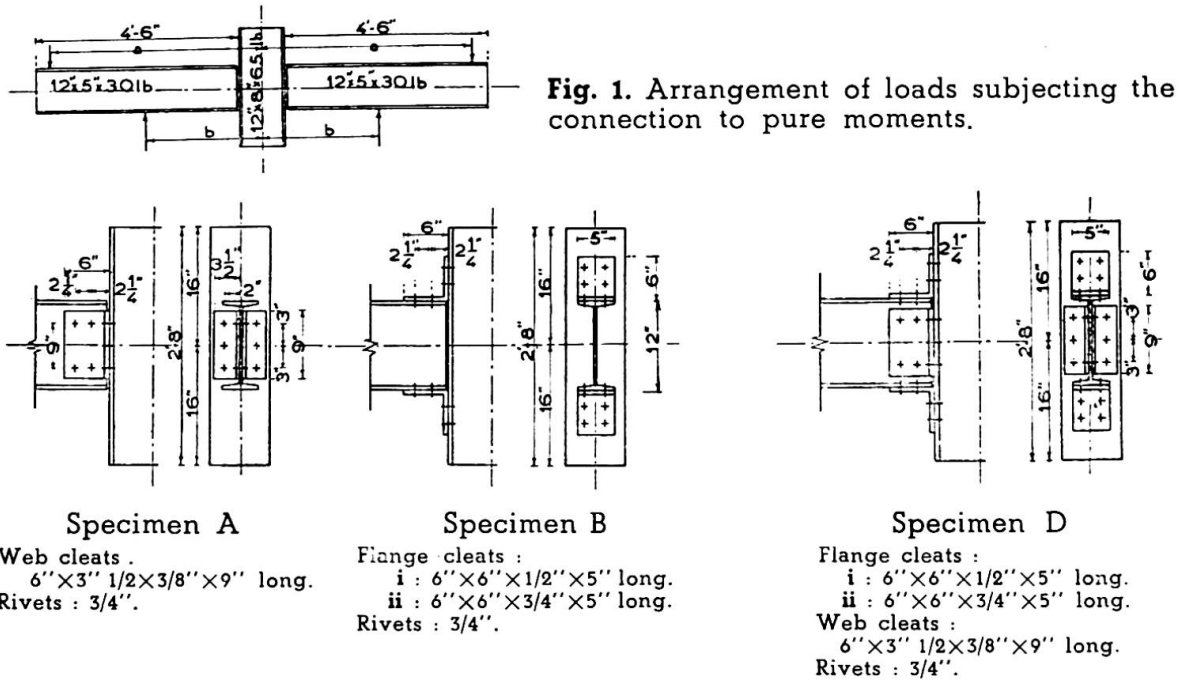

of the latter, while table II, fig. 2, shows the increase in the moments in curve D over those in curve B, expressed as a percentage of the the latter. Table II, therefore, indicates the influence of web cleats on the rigidity of the connection although, in these particular test specimens, the web cleats employed were relatively thin and very shallow.

Among the results of an independent investigation by Professor J. C. Rathbun ⁽²⁾ are the four moment-angle curves shown in fig. 3, which

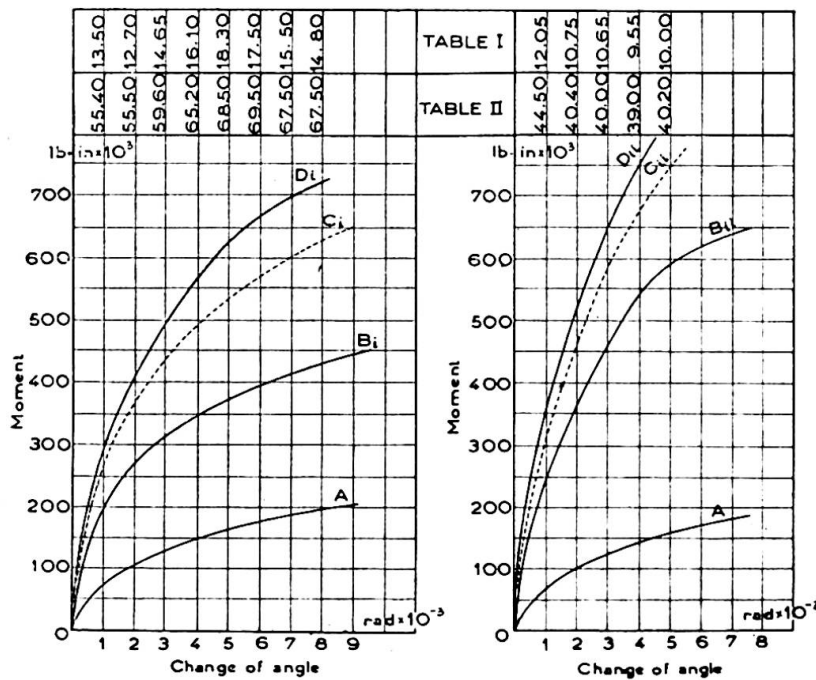

Fig. 2. Moment-angle curves obtained for the connections shown in fig. 1.

- A : Web-cleats only.
- B : Flange-cleats only.
- C : A + B.
- D : Experimental curve for both the web and the flange cleats.

⁽²⁾ *Elastic Properties of Riveted Connections* (Trans. Am. Soc. Civ. Eng., vol. 101, 1936).

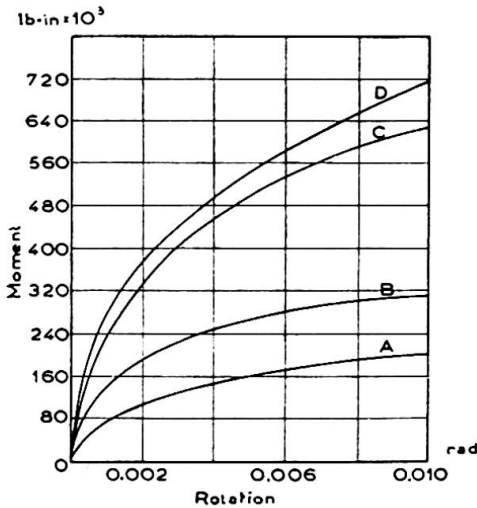

Fig. 3. Moment-angle curves obtained for the connections shown in fig. 4.

were obtained for the four types of connections given in fig. 4. The moment-angle curve (D) for the web-cleat connection of the 18-inch beam proves that in deep beams the rigidity of the connection is substantial.

It is common practice to neglect the stiffness of web-cleat connections in design. The above-quoted results, however, suggest that the rigidity of such connections should be taken into account. Actually, a very considerable number of experiments would be needed to furnish data to establish by experiment standard moment-angle curves for various web-cleat connections, corresponding to those already established for flange-cleat connections. The specimens required would have to be so detailed as to include all the items affecting the behaviour and deformation of the connections, and a considerable experimental programme would be involved. In the absence of such a programme, it is the purpose of the present paper to suggest a way in which standard moment-angle curves for web-cleat connections may be derived from similar curves for connections having only upper and lower flange cleats.

Behaviour of the web-cleat connection under moment

If a plate A is connected to a rigid structure B by means of two angles, as shown in fig. 5, and subjected to a pull F, then the behaviour of these connecting angles will be similar to the behaviour of the tension cleat in a flange-cleat connection subjected to a bending moment (fig. 6), and will also be similar to the behaviour of the part of the web-cleat above the neutral axis in a web-cleat connection subjected to a bending moment

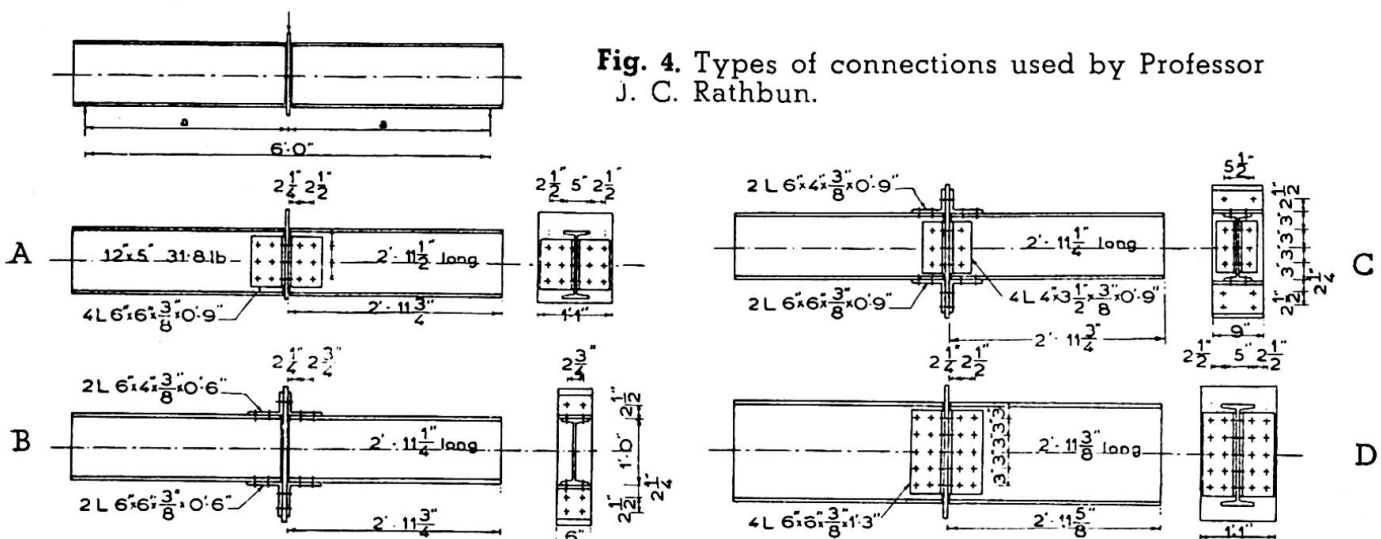

Fig. 4. Types of connections used by Professor J. C. Rathbun.

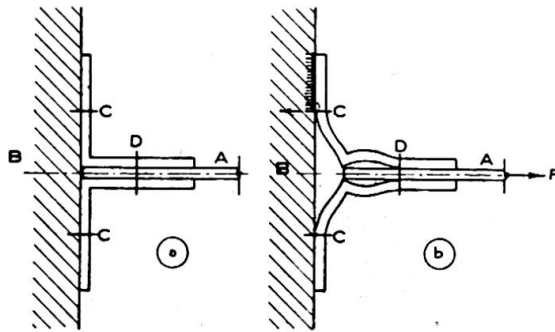
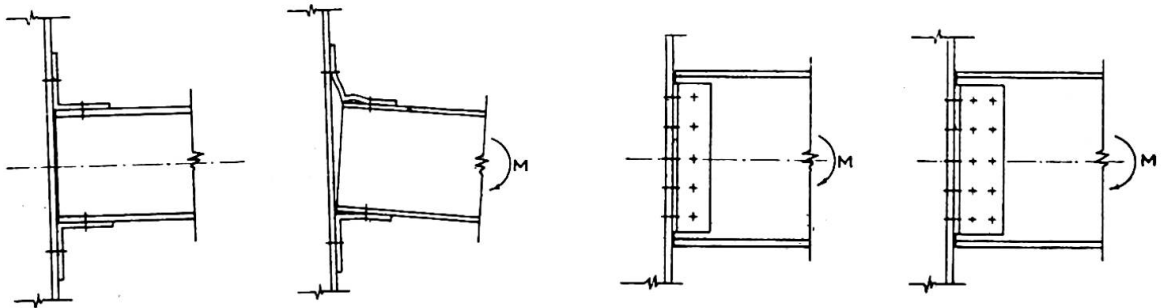

Fig. 5. Connection of a plate A to a rigid structure B by means of two angles C.

Fig. 6 and 7. Flange cleat connections subjected to a bending moment.



(fig. 7). In both cases, the angles are subjected to a similar pull and will undergo a similar deformation, with the exception that in a web-cleat connection the pull is of varying intensity. In the same way, the behaviour of the compression cleat in a flange-cleat connection can be shown to be similar to the behaviour of the part of the web cleat below the neutral axis in a web-cleat connection under moment.

In general, all the factors causing deformation in the case of flange-cleat connections will have similar effects in the case of web-cleat connections. These factors may be classified with respect to flange-cleat connections as follows :—

1. The elastic deformation of the cleat legs regarded as two beams rigidly connected together at the corner.
2. The plastic deformation of the connecting rivets and angles. This is evidenced by two facts : (a) No part of the moment-angle curve shows a linear relationship; (b) A permanent set takes place even at low moments, as was proved by the unloading curves.
3. The closing-in of the compression cleat towards the face of the stanchion due to the fact that the surfaces are not initially in perfect contact. This is indicated in fig. 8b which records the horizontal movements of the bottom flange of a test beam ⁽³⁾ showing that the compression cleat is not prevented from bending.

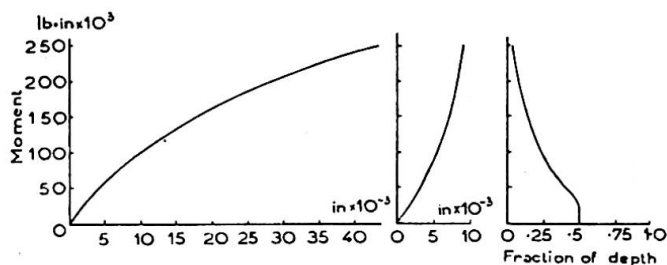

Fig. 8. Horizontal movement of top flange; horizontal movement of bottom flange; distance of centre of rotation from bottom of beam.

⁽³⁾ *Second Report of the Steel Structures Research Committee of the Department of Scientific and Industrial Research (H. M. S. O.), 1934, page 108*

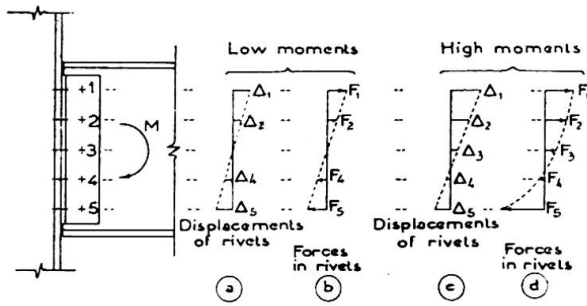

Fig. 9.

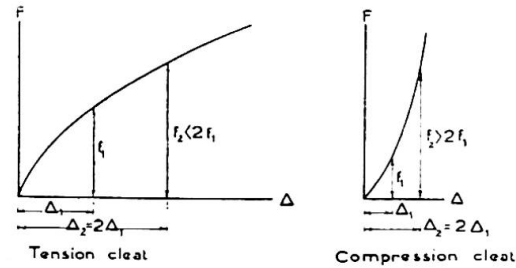

Fig. 10.

4. The slip between the flanges of the beam and the horizontal legs of the connecting angles due to the rivets not completely filling the rivet holes after cooling. This slip takes place at high moments when the forces transmitted by these rivets exceed the frictional forces due to their initial tension.

5. The variation in the initial tension in the rivets. This variation depends on fabrication and affects the elastic deformations.

Therefore, in the initial stages of applying a gradually-increasing moment to a web-cleat connection the initial clearance which in practice exists between the face of the stanchion and the back of the web cleats permits the compression part of the web cleat to bend freely in a similar way to the tension part. Thus, the closing-in of the lower parts is very nearly equal to the opening-out of the upper parts at the same distances from the centre line of the beam, with the result that the neutral axis is very nearly at the axis of the beam, and the forces F_1 to F_5 (fig. 9b) in the connecting rivets attached to the web of the beam are very nearly proportional to their distances from the neutral axis.

As closing-in is gradually stopped with increase of the applied moment, the lower parts are restrained from bending freely, while the opening-out of the upper parts is continued at an increasing rate, and the neutral axis of the connection moves gradually downwards (fig. 8c). This phenomenon is continued until failure of the connection takes place due to (a) excessive yield in the tension part of the cleat, (b) excessive deformation of the topmost row of rivets attached to the stanchion, or (c) crushing or shearing failure of the lowest rivet attached to the beam under the excessive force it sustains.

For higher moments, assuming that the cross section of the beam web through the connecting rivets which are firmly attached to it remains plane after deformation, the horizontal displacements Δ_1 to Δ_5 (fig. 9c) of the rivets will still follow a straight line. But the forces in the rivets will no longer be in a linear relationship, because the ratio $\frac{F}{\Delta}$ at any place must correspond to the $F - \Delta$ curves⁽⁴⁾ obtained for tension and compression cleats in flange-cleat connections (fig. 10).

From the shape of these curves, it follows that at high moments, due to the linear displacements, the distribution of the forces between the connecting rivets attached to the beam web will follow the curve given in fig. 9d.

⁽⁴⁾ See Appendix, p. 117, of this *Preliminary Publication*.

Derivation of moment-angle curves for a web-cleat connection

Two methods of derivation of the moment-angle curves for web-cleat connections will be given, the first on the basis of conditions at low moments, and the second on the basis of conditions at high moments near failure.

a) *Low-Moment Assumption.*

When a gradually-increasing couple M' is applied to the web-cleat connection shown in fig. 11 a, the connecting rivets attached to the web of the beam resist the couple. Forces in a very nearly linear relationship are created in these rivets as shown in the figure. This distribution of forces takes place only at low moments, as stated previously. The extreme rivets exert the maximum resistance F_1 in a direction normal to the riveting line, and it can easily be shown that

$$F_1 = \frac{M' \times Y_1}{\sum Y^2}$$

where Y is the distance of any rivet from the axis of the beam.

If the force F_1 on the upper rivet is responsible for the deformation of the upper strip p_u , and F_1 on the lowest rivet is responsible for the deformation of the lowest strip p_l , then, on the basis of linearity of displacements, it follows that the angular deformation of the connection is equal to the sum of the two displacements of n and n' divided by the distance D' between n and n' (fig. 11b).

Now the resistance to moment of the web-cleat connection, consisting only of two such strips (fig. 11b) will be similar to that of a flange-cleat connection (fig. 12a) in which each flange cleat has a length $2p$ of the same section as the web cleats previously considered, and in which the depth D is equal to the distance D' between the centres of the upper and lower strips in the web-cleat connection.

Then it may be shown that, if the transformed curve of the flange-cleat connection is as given in fig. 12b, this curve will be the same for two

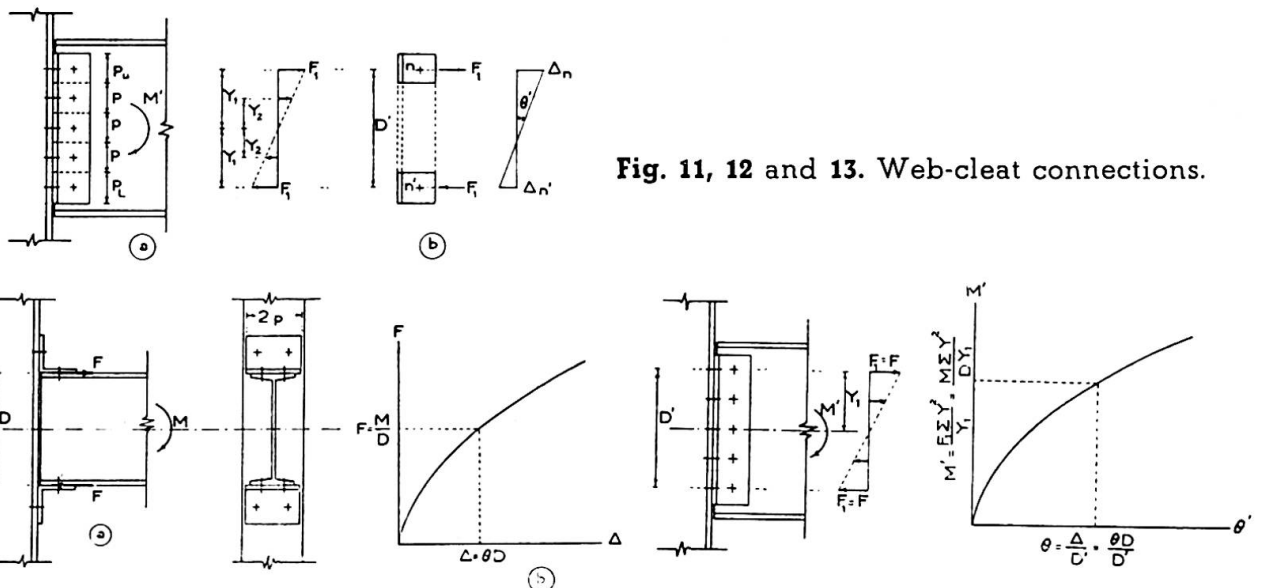
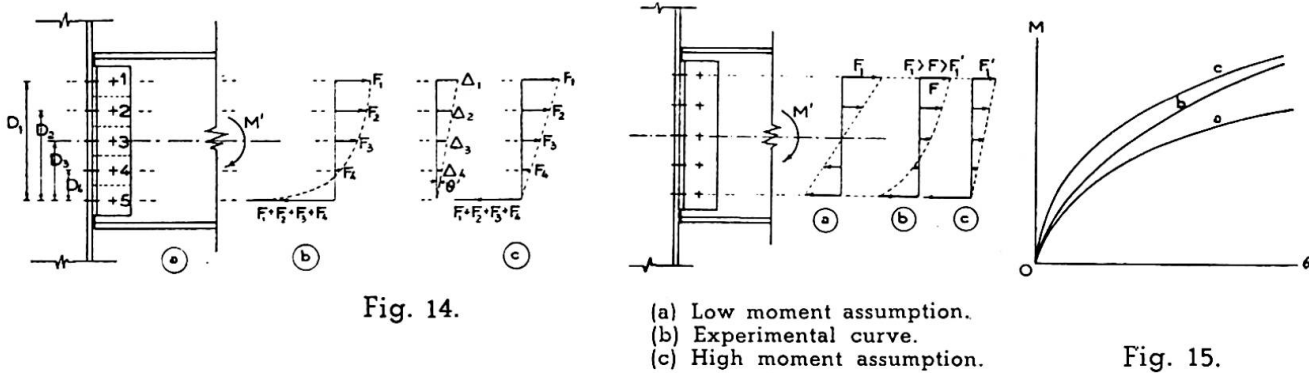

Fig. 11, 12 and 13. Web-cleat connections.



strips p_u and p_l of the web-cleat connection, whatever the values of D and D' are.

Let M' , the external moment acting on the whole web-cleat connection, produce in the upper and lower rivets the same pull as is produced in the rivets of the corresponding flange-cleat connection by the moment M .

$$\text{Then, } M' = \frac{F_1 \Sigma Y^2}{Y_1} = \frac{M}{D \times Y_1} \cdot \Sigma Y^2$$

the $F - \Delta$ curve being the same for both cleats in the two connections.

Let θ' be the angular rotation of the web-cleat connection due to the external moment M' .

$$\text{Then } \theta' = \frac{\Delta}{D'} = \frac{\theta \cdot D}{D'}$$

Δ being the same in both connections for the same pull.

Thus, a moment-angle curve $M' - \theta'$ (fig. 13) for the given web-cleat connection may be derived from a moment-angle curve $M - \theta$ for the corresponding flange-cleat connection, assuming low-moment conditions to exist throughout the whole range of the curve.

b) *High-Moment Assumption.*

In discussing the probable behaviour of web-cleat connections under high-moment conditions, it was stated that the neutral axis moves towards the compression fibres as the applied moment increases. In the final stages, the extreme rivet in the compression zone will probably act alone in compression, while the other connecting rivets are in tension. This assumption is thought to be reasonable—at failure—for web-cleat connections having up to six rivets in line, in other words, the assumption covers all practical conditions.

The distribution of forces between the connecting rivets will be as shown in fig. 14b, as previously mentioned. Assuming the distribution on the tension side to be linear (as in fig. 14c), and treating the web-cleat strips in the tension zone as flange cleats acting at different lever arms $D_1, D_2 \dots D_n$ from the centre line of the compression strip counteracting them all, a moment-angle curve for the web-cleat connection may be derived as follows :

For any given angular rotation θ' there correspond certain horizontal displacements $\Delta_1, \Delta_2 \dots \Delta_n$. From an $F - \Delta$ curve of a similar flange-cleat connection, the values of the forces $F_1, F_2 \dots F_n$ corresponding to $\Delta_1, \Delta_2 \dots$

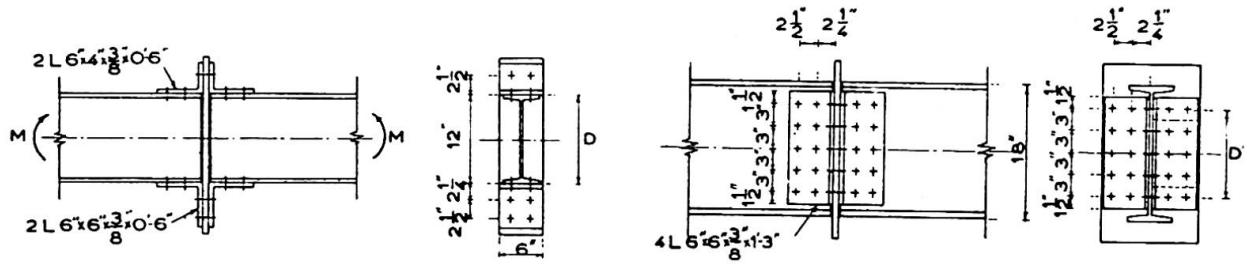

Fig. 16.

Δ_n may be estimated. The bending moment M' to which these displacements and forces correspond may be arrived at by taking moments about the compression rivet, i.e., $M' = \Sigma F \times D$. Thus, a moment-angle curve $M' = \theta'$ for the given web-cleat connection may be derived assuming high-moment conditions to exist throughout the whole range of the curve.

There are certain dissimilarities between the web-cleat connection under consideration and the flange-cleat connection used in the derivation of these curves. The rivets connecting the beam flange to the flange cleat in the second type act in single shear or bearing, while the rivets connecting the beam web to the web cleats in the first type act in double shear or bearing, and the thickness of the beam flange connected to the flange cleats in the second type is different from the thickness of the beam web connected to the web cleats in the first type. It is thought, however, that these dissimilarities are unimportant and that their influence on the rotation of the connection is negligible.

The main point affecting the results is the assumption of a linear distribution of the forces created in the connecting rivets attached to the beam web at extreme conditions of low and high moment. Whereas the actual distribution according to the experimental evidence is as in fig. 15*b*, this is idealized for low-moment conditions to the form shown in fig. 15*a*, and for high-moment conditions to the form shown in fig. 15*c*. Consideration of these figures will show that if the assumption of low-moment conditions is made, the fraction of the external moment resisted by the uppermost rivet is greater than it would be on the basis of the actual distribution of forces; if the assumption of high-moment conditions is made, the reverse is true. It follows that, for a given moment, the θ value on the first assumption is greater than the actual value, whereas on the second assumption it is smaller. In other words we should expect the derived $M - \theta$ curve to be everywhere lower than the actual curve on the first assumption, the two curves showing more or less coincidence near the origin and then diverging as the applied moment increases, as shown in fig. 15*d*. On the other hand, the $M - \theta$ curve derived on the assumption of high-moment conditions will lie above the actual $M - \theta$ curve for the same connection, the two curves diverging near the origin and coinciding more or less as the applied moment increases, as shown in fig. 15*d*.

Application of the methods of derivation to experimental results

Among the experimental results available, there are only two experiments⁽⁵⁾ which may be used as a yardstick against which the methods

⁽⁵⁾ RATHBUN, *Elastic Properties of Riveted Connections* (Trans. Am. Soc. Civ. Eng., vol. 101, 1936).

of derivation given above may be examined to test to what extent they are justified. The two specimens concerned (fig. 16) are not ideally suited for the purpose as the compression cleat in the flange-cleat connection has one row of rivets in the vertical leg while the web-cleat connection has two rows. This difference is, however, unimportant since the major part of the deformation comes from the tension cleat, which has the same dimensions and details in both specimens; moreover, the closing-in which is the distinctive deformation of the compression cleat, appears to be of equal tendency in both connections due to similarity up to the first row of rivets.

a) *Low-moment Assumption.*

For a gradually-applied couple M' , let the force resulting in the furthest rivet be S_1 (fig. 17). Let point O be the centre of rotation of the rivet group and x_1, x_2 , etc. denote distances from this centre of rotation to the individual rivets.

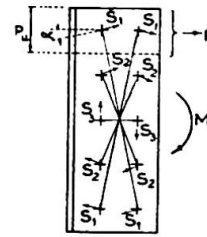

Fig. 17.

Then, according to the usual assumptions :

$$S_1 = \frac{M' x_1}{\sum x^2}$$

Also, if $F =$ the force on the upper strip p_u .

Then, $F = 2 S_1 \cos \alpha$.

Fig. 18 shows the experimental $M - \theta$ curve for the flange-cleat connection. From it, the $M' - \theta'$ curve (fig. 19A) for the web-cleat connection may be derived as follows :—

$$\text{Since } M' = \frac{S_1 \sum x^2}{x_1} \quad \text{and} \quad S_1 = \frac{F}{2 \cos \alpha}$$

$$\begin{aligned} \text{Therefore } M' &= \frac{F \sum x^2}{2 \cos \alpha (x_1)} \\ &= \frac{M \sum x^2}{2 x_1 D \cos \alpha} \end{aligned}$$

(since $F = \frac{M}{D}$ in the case of the flange-cleat connection).

$$\text{Also } \theta' = \frac{\theta D}{D'}$$

Values of M' and θ' may therefore be calculated to correspond to the experimental values M and θ . These values are given in table III.

Experimental Values for Flange-Cleat Connection (fig. 18)		Derived Values for Web-Cleat Connection (fig. 19 A)	
M (In. lb. 10 ³)	θ (Rad)	$M' = \frac{M \sum x^2}{2 \cos \alpha (x_1 D)}$	$\theta' = \frac{\theta \cdot D}{D'}$
140	0.001	189	0.001
195	0.002	263	0.002
227	0.003	306	0.003
248	0.004	335	0.004
264	0.005	358	0.005
276	0.006	373	0.006

TABLE III.

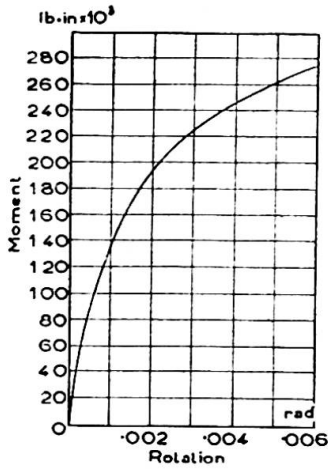

Fig. 18. Moment-angle curve for the flange cleat connection of fig. 16.

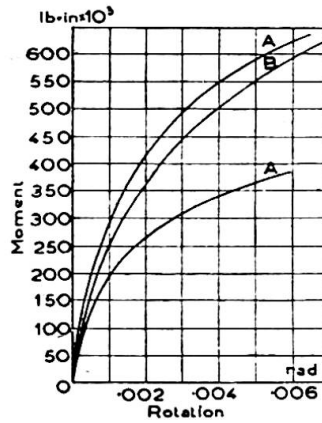

Fig. 19.

A : Derived $M-\theta$ curve according to low moment assumption.
 B : Experimental $M-\theta$ curve.
 C : Derived $M-\theta$ curve according to high moment assumption.

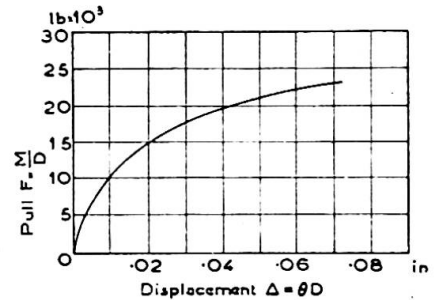

Fig. 20. $F-\Delta$ curve for the flange cleat connection of fig. 16.

b) *High-moment Assumption*

Fig. 20 gives the transformed $F-\Delta$ curve for the flange-cleat connection as deduced from fig. 18. Following the steps stated previously for high-moment conditions, and referring to fig. 14, table IV may be completed.

θ (Rad)	Rivet N° 1		Rivet N° 2		Rivet N° 3		Rivet N° 4		M' $= F_1 D_1 + F_2 D_2$ $+ F_3 D_3 + F_4 D_4$ (in. lb)
	Δ_1 (in)	F_1 (lb)	Δ_2 (in)	F_2 (lb)	Δ_3 (in)	F_3 (lb)	Δ_4 (in)	F_4 (lb)	
	$12'' \times \theta'$		$9'' \times \theta'$		$6'' \times \theta'$		$3'' \times \theta'$		
0.001	0.012	11 700	0.009	10 000	0.006	7 750	0.003	5 000	292 500
0.002	0.024	16 200	0.018	14 150	0.012	11 750	0.006	7 750	415 500
0.003	0.036	19 000	0.027	17 000	0.018	14 150	0.009	10 000	495 900
0.004	0.048	20 700	0.036	19 000	0.024	16 200	0.012	11 750	551 850
0.005	0.060	22 200	0.045	20 250	0.030	17 600	0.015	13 000	593 250
0.006	0.072	23 100	0.054	21 500	0.036	19 000	0.018	14 150	627 150

TABLE IV.

The two moment-angle curves obtained for the web-cleat connection, according to tables III and IV, are shown in fig. 19 together with the experimental curve for the same connection. The two derived curves are located as expected with reference to the experimental one. The low-moment assumption method, which will be taken as a basis for deriving standard moment-angle curves, gives a curve well within the working range of the connection, and offering a certain margin of safety. The divergence of this curve from the experimental one with increase in applied moment is not serious viewed in the light of the range of variation of the

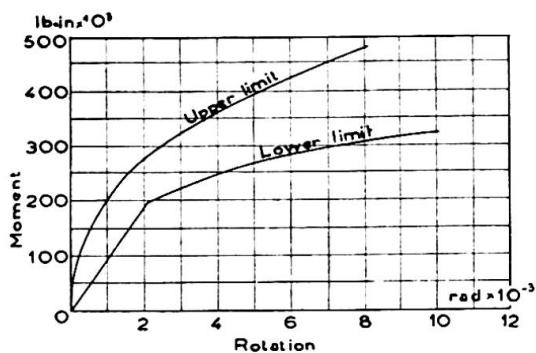

Fig. 21.

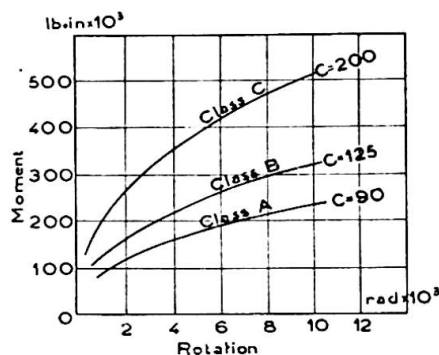

Fig. 22. Standard curves for classified flange cleat connections.

upper and lower limit experimental curves for seven similar specimens for one special connection ⁽⁶⁾ (fig. 21). Moreover, the experimental curve in the previous example is for a single experiment on a 3/8" cleat where great discrepancies are to be expected, the cleats being thin.

Standard curves for web-cleat connections

In the Final Report of the Steel Structures Research Committee, flange-cleat connections were classified into three classes having different standard moment-angle curves with 12-in beam depth (fig. 22). The equations of these curves are shown to be of the form $M = C(1\ 000 \times \theta)^{0.412}$, where C is a constant depending on the class of connection and equals 90, 125 and 200 respectively. Web-cleat connections could similarly be classified (table V) into three classes having three different standard moment-angle curves for each given depth of web cleat or in other words for each number of rows of the connecting rivets or bolts, the rivets and bolts specified in table V being symmetrically arranged about the horizontal axis of the beam.

The derivation, according to the assumptions given before, of the standard moment-angle curve for the set of web-cleat connections having five rows of connecting rivets (fig. 23b), class A, is as follows:—

The equation of the moment-angle curve for the similar flange-cleat connection with 12-in beam depth is

$$M = 90(1\ 000 \times \theta)^{0.412}$$

i.e.,
$$D \times F = 90 \left(1\ 000 \cdot \frac{\Delta}{D} \right)^{0.412}$$

or
$$\frac{D \times M' \times Y_1}{\Sigma Y^2} = 90 \left(1\ 000 \cdot \frac{\theta' \times D'}{D} \right)^{0.412}$$

i.e.,
$$\frac{12 \times 6}{2(6^2 + 3^2)} \cdot M' = 90 \left(1\ 000 \times \frac{12}{12} \times \theta' \right)^{0.412}$$

Therefore
$$M' = 112.5 (1\ 000 + \theta')^{0.412}$$

⁽⁶⁾ Final Report of the Steel Structures Research Committee of the Department of Scientific and Industrial Research, (H. M. S. O.), 1936, p. 283.

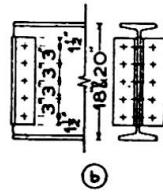
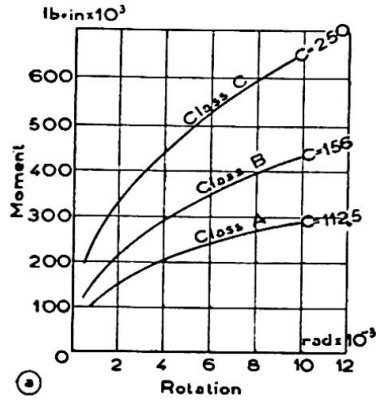

Fig. 23. Proposed standard curves for classified web cleat connections with five rows of rivets.

which is an equation of the same form as those given for flange-cleat connections, but having a different constant C.

For the other two classes—with the same depth and number of connecting rivets or bolts as specified in table V—the constant C is 156 and 250 respectively. The corresponding M — θ curves are given in fig. 23a.

In the same manner, moment-angle curves could be derived for the three classes of connections with different web-cleat depths.

Class	Connection (The first dimension shown is that of the cleat leg connected to the beam web)	Bolts or Rivets	
		To beam	To stanchion
A	6 in × 4 in × $\frac{1}{2}$ in web cleats	Ten $\frac{3}{4}$ in rivets	Ten $\frac{3}{4}$ in mild steel bolts
	4 in × 4 in web cleats, thickness $\geq \frac{1}{2}$ in	Five $\frac{3}{4}$ in rivets	Ten $\frac{3}{4}$ in rivets or ten $\frac{3}{4}$ in high tensile steel bolts at 3 000 lb-in torque
	6 in × 4 in × $\frac{3}{8}$ in web cleats	Ten $\frac{3}{4}$ in rivets or ten $\frac{3}{4}$ in high tensile steel bolts at 3 000 lb-in torque	Ten $\frac{3}{4}$ in rivets or ten $\frac{3}{4}$ in high tensile steel bolts at 3 000 lb-in torque
B	6 in × 4 in × $\frac{1}{2}$ in web cleats	Ten $\frac{3}{4}$ in rivets or ten $\frac{3}{4}$ in high tensile steel bolts at 3 000 lb-in torque	Ten $\frac{3}{4}$ in rivets or ten $\frac{3}{4}$ in high tensile steel bolts at 3 000 lb-in torque
C	6 in × 4 in × $\frac{3}{4}$ in web cleats	Ten $\frac{7}{8}$ in rivets or ten $\frac{3}{4}$ in high tensile steel bolts at 3 000 lb-in torque	Ten $\frac{7}{8}$ in rivets or ten $\frac{3}{4}$ in high tensile steel bolts at 3 000 lb-in torque

TABLE V.

The table V is for web-cleat connections with five rows of connecting rivets or bolts as shown in fig. 23b. Similar tables could be worked

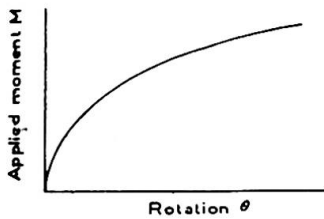

Fig. 24. Moment-angle curve for a flange cleat connection with 12" beam depth.

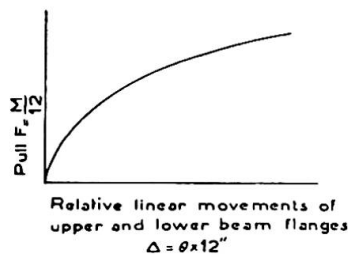

Fig. 25. Transformed curve for the flange connection whose $M-\theta$ curve is given in fig. 24.

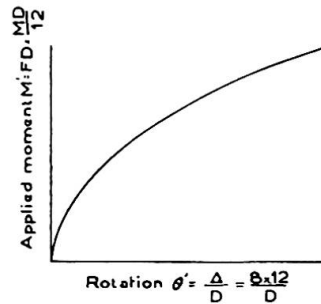

Fig. 26. Moment-angle curve for the same connection with another beam of depth D .

out for connections with different numbers of rows of connecting rivets or bolts.

Appendix. Transformed curve

The experimental tests given in the Reports of the Steel Structures Research Committee were carried out on beams 12 inches deep, and moment-angle curves of the form shown in fig. 24 were obtained for each connection. These curves were transformed so as to show directly the pull on the connection plotted against the relative linear movements of the ends of the upper and lower flanges. The results obtained could thus be used for such connections with beams of any depth. The pull F was arrived at approximately by dividing M by the depth of the beam (12 in). (This is exact in the case of a split-I connection. In flange-cleat connections, M should be divided by a slightly-increased lever arm.) The relative linear movement Δ is obtained by multiplying the abscissa by the depth 12 in of the beam (fig. 25).

Following the same principle, a moment-angle curve may be drawn for the same connection attached to beams of any depth D by multiplying each ordinate F of the $F-\Delta$ curve by D to get M' , and dividing the abscissa Δ by D to get θ' (fig. 26).

Experiments on beams of depths ranging from 10 in to 18 in were carried out and showed that the above-mentioned method was sufficiently accurate for all practical purposes.

Résumé

Des essais systématiques effectués en Angleterre et aux Etats-Unis ont permis d'établir des relations entre le moment appliqué et la déformation angulaire entre poutre et montant suivant le type d'assemblage. Certains essais furent réalisés par goussets mais ne permirent pas d'extrapoler une relation avec suffisamment de précision pour ce type de liaison. Les auteurs proposent de déduire la courbe de liaison âme-gousset de celle entre aile et gousset. Ils donnent deux méthodes de dérivation de ces courbes, selon qu'il s'agit de faibles ou de forts moments, et montrent que la courbe réelle doit se trouver entre ces deux courbes. Une série d'essais confirme ce point de

vue. Les auteurs proposent la mise au point d'assemblages types conformément aux spécifications américaines élaborées par le *Steel Structures Research Committee of the Department of Scientific and Industrial Research for flange-clip connections*. Pour conclure, les auteurs donnent les relations recherchées pour quelques cas particuliers.

Zusammenfassung

Systematische Untersuchungen in England und Amerika an einer Reihe von Verbindungen zwischen Balken und Stützen mit nur Flansch-Befestigungswinkeln haben Zusammenhänge zwischen dem angreifenden Moment und dem Verdrehungswinkel ergeben. Einige auch an Verbindungen mit Steg-Befestigungswinkeln durchgeführte Versuche erlauben aber noch nicht, auch für diese Ausbildungsart entsprechende Beziehungen aufzustellen. Die Verfasser schlagen deshalb deren Abteilung aus den Kurven der Verbindungen mit Flansch-Befestigungswinkeln vor. Zwei Ableitungsmethoden für die Fälle kleiner, resp. grosser Momente werden gegeben, und es wird gezeigt, dass die wirkliche Moment-Drehwinkel-Kurve zwischen den so erhaltenen Kurven liegen muss. Dies bestätigt auch die Kontrolle der Methode an Hand der wenigen veröffentlichten Versuche. Es wird vorgeschlagen, eine Zusammenstellung von Muster-Verbindungen mit Steg-Befestigungswinkeln auszuarbeiten, entsprechend der im *Final Report of the Steel Structures Research Committee of the Department of Scientific and Industrial Research* bereits vorhandenen Zusammenstellung über Verbindungen mit Flansch-Befestigungswinkeln. Schliesslich werden mit der im vorliegenden Aufsatz entwickelten Methode die Gleichungen der Moment-Drehwinkel-Kurven einiger typischer Fälle von Verbindungen mit Steg-Befestigungswinkeln bestimmter Stärke abgeleitet.

Summary

Systematic experimental studies both in England and America have established relationships between applied moment and change of angle between beam and stanchion for a range of beam-to-stanchion connections having flange cleats only. Some experimental work has been done on web-clip connections but this has not been on a sufficient scale to enable moment-angle relationships to be obtained experimentally for such a range of connections as in the other case. The paper therefore proposes a method of deriving the curve for a web-clip connection from that for the corresponding flange-clip connection. Two methods of derivation are given, based on assumptions of low-moment and high-moment conditions respectively throughout the whole range and it is shown that the actual moment-angle curve should lie between those derived according to these two assumptions. Confirmation of this is obtained by applying the methods to the only suitable pair of experiments for which published information is available. It is suggested that a classification should be prepared of standard web-clip connections corresponding to that already available in the *Final Report of the Steel Structures Research Committee of the Department of Scientific and Industrial Research for flange-clip connections*. A typical set of three standard classes is assumed for web-clip connections of a given depth, and the methods developed in the paper are used to determine the equations of the moment-angle curves for each class.