

Zeitschrift: IABSE congress report = Rapport du congrès AIPC = IVBH
Kongressbericht

Band: 4 (1952)

Artikel: The use of high-strength steel in ordinary reinforced and prestressed
concrete beams

Autor: Abeles, P.W.

DOI: <https://doi.org/10.5169/seals-5072>

Nutzungsbedingungen

Die ETH-Bibliothek ist die Anbieterin der digitalisierten Zeitschriften. Sie besitzt keine Urheberrechte an den Zeitschriften und ist nicht verantwortlich für deren Inhalte. Die Rechte liegen in der Regel bei den Herausgebern beziehungsweise den externen Rechteinhabern. [Siehe Rechtliche Hinweise.](#)

Conditions d'utilisation

L'ETH Library est le fournisseur des revues numérisées. Elle ne détient aucun droit d'auteur sur les revues et n'est pas responsable de leur contenu. En règle générale, les droits sont détenus par les éditeurs ou les détenteurs de droits externes. [Voir Informations légales.](#)

Terms of use

The ETH Library is the provider of the digitised journals. It does not own any copyrights to the journals and is not responsible for their content. The rights usually lie with the publishers or the external rights holders. [See Legal notice.](#)

Download PDF: 07.10.2024

ETH-Bibliothek Zürich, E-Periodica, <https://www.e-periodica.ch>

CII 2

The use of high-strength steel in ordinary reinforced and prestressed concrete beams

Emploi de l'acier à hautes résistances dans les poutres en béton armé ordinaire et précontraint

Die Verwendung von hochwertigem Stahl in gewöhnlichen und vorgespannten Eisenbetonbalken

P. W. ABELES D.Sc. (VIENNA), M.I.STRUCT.E., M.AM.SOC.C.E.
Civil Engineer's Department, The Railway Executive, Eastern Region, London

INTRODUCTION

High-strength steel is not generally used in ordinary reinforced concrete because of the danger of excessive cracking with small extension of the concrete. For a long time only mild steel was used and the permissible stresses were limited, but later work-hardened deformed steel bars were introduced and higher steel stresses were allowed, the extent of cracking being limited because of better bond conditions obtained. Plain bars have been excluded mainly because of the very smooth surface. The author had the opportunity of investigating the use of plain high-strength steel bars in connection with spun-concrete poles¹ and ordinary rectangular beams² which showed limited width of individual cracks, because owing to good bond a great number of fine cracks developed. Further tests on spun-concrete tubular beams³ indicated that the concrete tensile zone co-operates greatly up to failure, in spite of the development of cracks. The resistance moment of such slightly reinforced beams was so high that the nominal steel stress, computed for this resistance moment and a lever arm equalling the depth, considerably exceeded the strength of the work-hardened steel used. Extensive tests carried out by Dr. Hajnal-Konyi⁴ on beams reinforced with work-hardened square twisted bars in 1942/43 proved that the full strength of such bars could be reached at failure (and not as previously assumed only at the yield-point stress) when the size of the bars was below $\frac{1}{2}$ in. (1.25 cm.). In these tests even a nominal stress in excess of the strength of the steel was obtained. Further tests by Dr. Hajnal-Konyi⁵ showed that an increase in ultimate resistance approaching the ultimate strength of cold-worked steel is possible also with bars of larger size provided that an increased bond resistance by surface patterns is ensured.

¹ For references see end of paper

In ordinary reinforced concrete, no use has yet been made of the full strength of high-strength steel. With prestressed concrete, wire of extraordinary high-strength properties has been introduced and there has been no objection to permitting high steel-stresses when, under working load, only compressive stresses occur, as is the case with "full" prestressing, because any possibility of cracking is definitely avoided. The use of such high-strength wire became particularly advantageous when it was realised that losses of prestress, except that due to the creep of the steel, are independent of the steel stress and depend only on the magnitude of the concrete prestress, shrinkage and creep. The ultimate load conditions of prestressed concrete were rarely investigated. However, it has been realised that they are also of importance and must be considered. In the tests⁵ also the use, as reinforcement, of thin untensioned wire of very high strength, as preferably used in prestressed concrete, was investigated and it was found that approximately the same ultimate resistance can be attained as when the beam is prestressed. This shows that an investigation of the use of high-strength steel is possible on general lines for ordinary reinforced and prestressed concrete.

CRACKING

It was intended to investigate in the present paper not only the ultimate resistance of work-hardened steel and high-strength wire in concrete beams but also the behaviour of such structures generally. However, in view of the wide field, the question of cracking will be only briefly discussed, while the main part of the paper is devoted to ultimate load conditions.

With regard to cracking, reference may be made to the publications by Professor R. H. Evans,⁶ Dr. F. G. Thomas⁷ and the author.⁸ In reinforced-concrete beams, cracks become visible at a bending moment at which the computed bending tensile-stress in a straight-line distribution for a homogeneous material reaches the so-called modulus of rupture (bending tensile strength). This nominal stress depends on the tensile strength and plasticity of the concrete and on the shape of the cross-section. It may vary between 500 and 1,000 lb./in.² (35 to 70 kg./cm.²) for high-strength concrete. If prestressing is applied, this stress seems to be higher than in ordinary reinforced concrete of the same properties but it would appear that actual cracking commences at the same state, the cracks being invisible at first to the unaided eye. Professor Evans has shown⁶ that by measurements with a high-powered microscope fine cracks of a depth of 1/20 in. (1.25 mm.) and a width of 1/15,000 in. (1/600 mm.) may be detected when the unaided eye does not notice cracking. In a recent publication⁹ results of investigations by Wenzel and Suhrmann were shown, according to which the intensity of the transmitted pulse was measured by supersonic methods. A reduction of intensity was already noticed at 40% of the load at which cracks became visible, and at the latter load only 40% of the intensity was transmitted. The same investigations also showed that the intensity was reduced to zero long before failure occurred. This method of measurement is based on the fact that even a very narrow air-filled crack reflects the ultrasonic pulse almost completely, and thus a reduction in intensity transmitted indicates the occurrence of cracks. However, when comparing the results mentioned with the actual strength properties, it would appear that such fine and very shallow invisible cracks do not affect the strength properties. With increased prestress the state at which cracks become visible may be further delayed, but commencement of cracking can be inferred from the load-deflection line, even if the cracks are not visible, as was shown in the tests.¹⁰

From the author's paper ⁸ it is seen that cracks not exceeding 0.01 in. (0.25 mm.) can be considered as harmless from the point of view of corrosion. With concrete reinforced with ordinary mild steel designed in accordance with the permissible stresses, cracks of even greater width may occur if the concrete is not cured and the influence of shrinkage is great, which is often the case. If the concrete is vibrated a much denser material is obtained and the danger of corrosion is reduced. When considering only the state of cracking, high-strength steel could be used provided the bars were of relatively small cross-section or increased bond resistance were ensured by surface patterns on the reinforcement; even plain high-tensile wire might be used. Nevertheless, it does not seem advisable to use plain high-strength wire in view of the great deflection of such members. By prestressing the entire reinforcement or part of it, cracking under working load can be avoided altogether or its extent limited to a desired degree. For example, it is possible to design a structure in such a way that under ordinary (dead) load no tensile stresses occur and thus any cracks close entirely, while under working load cracks may temporarily open up. As long as this loading is not sustained longer than a certain period, these temporary cracks can be ignored. In view of the author's investigation,⁸ even visible fine cracks are harmless with regard to corrosion, but where heavy impact takes place the occurrence of cracks should be avoided altogether unless further investigations have proved that such impact is harmless. In tests ¹⁰ it was shown that cracks in prestressed beams with bonded wires close completely on unloading even if the failure load is approached. Advantage can be taken of this great resilience by providing a prestressing force of such magnitude that a considerable range is obtained between noticeable deflection and cracking and failure, as suggested by the author in his paper ¹¹ and embodied in Appendix 2 of the "First Report on Pre-stressed Concrete."¹²

Reference may be made to recent fatigue tests ¹³ for British Railways carried out at Prof. Campus' Laboratory in Liège on partially prestressed composite members with tensioned and untensioned wires. These members were tested in a cracked state. In one case one million repetitions of loading were applied in a range corresponding to 100 lb./in.² compressive stress and approximately 600 lb./in.² nominal tensile stress (7 and 42 kg./cm.² respectively); after this fatigue test the cracks became entirely invisible. In a second case three million repetitions were applied and after each million the loading was increased so that for the third million nominal tensile stresses of approximately 1,000 lb./in.² (70 kg./cm.²) occurred; after this test very fine cracks were visible. It is noteworthy that just before completion of the third million repetitions, two tensioned wires fractured in gaps provided for affixing the gauges; nevertheless the maximum calculated ultimate resistance was reached at a static failure test, in spite of the previous fatigue loading, as discussed later (see Table VII—slab S2).

ULTIMATE RESISTANCE

The elastic theory is quite suitable for working-load conditions but does not agree with failure conditions. The author showed in 1935/7 ^{1, 14} that with ordinary reinforced concrete for various percentages of reinforcement quite different factors of safety are obtained when the design is based on permissible stresses. If cases are excluded at which failure occurs owing to shear or slipping of the steel, two cases must be distinguished, i.e. under-reinforced beams when failure is primarily due to the steel (either fracture or excessive elongation of steel followed by crushing of the concrete), and over-reinforced beams where failure is due to crushing of the concrete at a state

when extension of the steel is relatively small and no warning is given of imminent failure. Some of the special methods which were suggested a long time ago have been discussed by Prof. R. H. Evans,¹⁵ Dr. K. Hajnal-Konyi¹⁶ and the author.^{1, 14, 17} The following names and dates may be mentioned: L. J. Mensch (1914), H. Kempton-Dyson (1922), F. Emperger (1931), Prof. F. Stüssi (1932), Dr. F. Gebauer (1933), Dr. C. Schreyer (1933), S. Steuermann (1933), Dr. E. Bittner (1935/6), Prof. R. Saliger (1936), Charles S. Whitney (1937), Kenneth C. Cox (1941), Prof. V. P. Jensen (1943) and R. H. Squire (1943). In addition to these methods three further suggestions may be mentioned, e.g. those of Prof. A. L. L. Baker,¹⁸ Mr. J. W. King¹⁹ and Prof. Hjalmar Granholm.²⁰

Professor R. H. Evans has shown in his paper¹⁵ that there is little difference in the results of the various methods, and it seems therefore most advisable to employ the simplest solution. All methods are only approximations, though it is claimed by some proposers that they have presented exact formulae based on strain consideration. However, it must not be forgotten that there is a great variety in the behaviour of concretes of different mixes, and practically any property may be obtained.¹⁴ Whitney has shown²¹ that the resistance stress at failure $Q = M_m / (b \cdot d^2)$ approximates to $f'_c / 3$, where f'_c is the cylinder strength if f'_c exceeds 2,500 lb./in.² while for lower values of f'_c higher values apply for Q / f'_c . Whitney suggested a rectangular compressive distribution of a stress $0.85 f'_c$ balancing the ultimate steel resistance. Kenneth C. Cox²² has modified this formula by introducing the entire cylinder strength instead of $0.85 f'_c$ for the rectangular stress distribution; but Whitney stated in the discussion

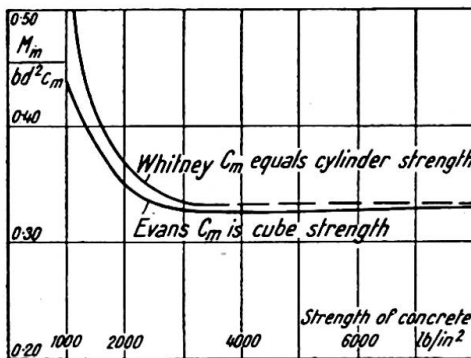

Fig. 1

that this applied only if the cylinder strength was obtained from specimens differing in size from the standard cylinder. Prof. Evans, in his paper,¹⁵ has come to the conclusion that the prism strength with high strength values approaches the cube strength and has introduced the cube strength for the compressive stress. Fig. 1 shows the results of Whitney's and Evans' investigations. The author, who took part in the discussion on these papers,^{21, 22} has used stress distributions according to Cox in his publications^{23, 24, 25} when dealing with ultimate load conditions, but would like to modify this method slightly in the following paragraphs.

The magnitude of the maximum compressive stress c_m , as shown in fig. 2(a),* depends mainly on the strength and plasticity of the concrete used. It will be appreciated that this measure could only be considered as a strength value if this strength were obtained from specimens of definite size. Take, for example, prisms; quite different sizes are being used with the consequence of different strength values. Thus the stress c_m cannot be taken as a strength value; but as a stress it may be considered as dependent on the strength; e.g. it can be assumed that $c_m = G \cdot c_u$, where c_u is the cube strength and G is a coefficient generally varying between 0.6 and 0.8, but c_m may also in certain circumstances equal the prism strength c_p . The second modification of the Whitney method consists in the assumption that the maximum equivalent depth of the rectangular stress-distribution is half the depth d , resulting in $M_{max} = 0.375 bd^2 c_m$. If G is taken as 0.6 a value of $M_{max} = 0.225 bd^2 c_u$ is

* In fig. 2, the formulae written with the symbols used in German-speaking countries are shown in parentheses.

obtained, as suggested by the author²⁵ and introduced in the "First Report on Prestressed Concrete."¹² Preliminary investigations have proved that this assumption agrees very well with test results, as may be seen from the charts, figs. 6 and 7.

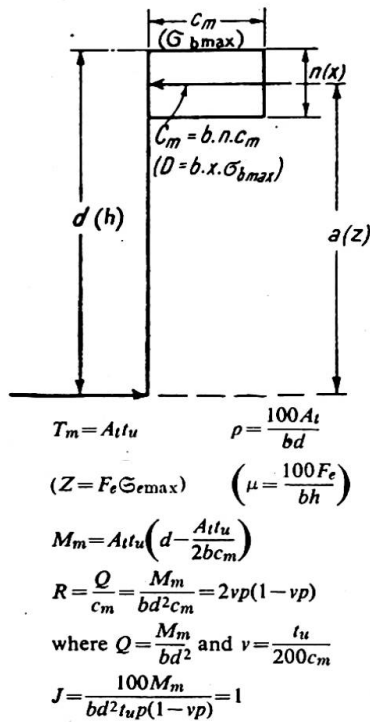

Fig. 2(a)

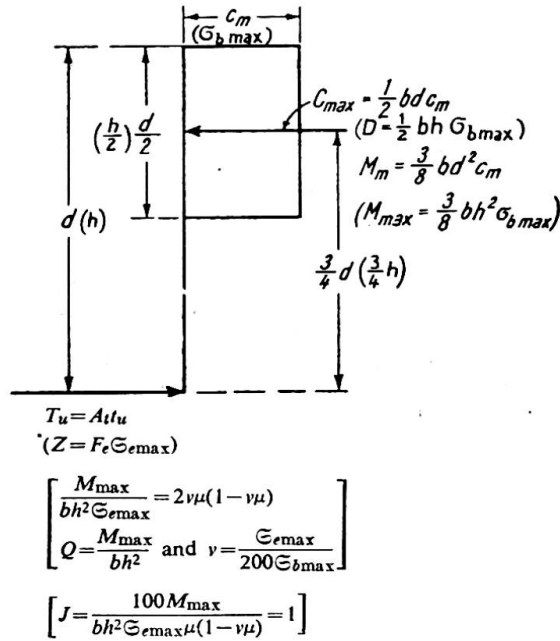

Fig. 2(b)

Fig. 2 shows the stress distribution at failure for (a) an under-reinforced section and (b) for balanced design, including formulae for balancing the ultimate resistances. The percentage of reinforcement for balanced design \bar{p} is determined by the relation $\bar{p} = 0.25/\nu = 50 c_m/t_u$, where $\nu = t_u/200 c_m$; t_u is the ultimate steel-strength (in certain cases it should be replaced by t_y , the yield-point stress), and c_m is the maximum concrete stress. The stress $Q = M_m/(b d^2)$ due to maximum bending moment M_m is investigated with regard to c_m and t_u . The stress-ratio $R = Q/c_m$, obtained from the test results, can be compared with the value $2 \nu p (1 - \nu p)$ obtained from the force equilibrium for under-reinforced beams. If R is greater than $2 \nu p (1 - \nu p)$, the calculation gives safe values. For over-reinforced beams ($p \geq \bar{p}$) the theoretical value is 0.375. Similarly the utilisation of the steel can be investigated by computing $J = 100 Q/(t_u \cdot p (1 - \nu p))$; the theoretical value is unity for under-reinforced sections and \bar{p}/p for over-reinforced sections. The steel strength is fully utilised if $J \geq 1$ or $J \geq \bar{p}/p$, where $p \geq \bar{p}$, while lower values of J indicate that full use is not made of the steel strength. J represents, in fact, the ratio t_m/t_u , were t_m is the steel stress in a cracked section calculated for the maximum bending moment. When the values for J obtained from test results are greatly in excess of the theoretical values, it must be assumed that the concrete tensile zone co-operates in spite of its interruption by cracks. In such a case the stress distributions according to fig. 2 would have to be modified by considering an average concrete tensile resistance, as, for example, has been suggested by the author in the discussion to Cox's paper.²²

These formulae have been investigated for a number of tests on prestressed and ordinary reinforced concrete beams, the cross-sections of which are shown in figs. 3 and 4 respectively. Fig. 3(a) relates to unpublished tests carried out by Stott at the

University of Leeds and fig. 3(b) to similar tests carried out by Revesz at the Imperial College, London. The author has obtained the data shown in Tables I and II from Profs. R. H. Evans and A. L. L. Baker respectively, to whom as well as to Messrs. Stott and Revesz he expresses his thanks. The test results are to be discussed in more detail in these.

The results of published Swiss tests,²⁷ omitting beam II reinforced with mild steel, and those of the Brixton School of Building^{28, 29} have been investigated, cross-sections

TABLE I

Data obtained from Prof. R. H. Evans regarding tests carried out by Mr. J. P. Stott at the University of Leeds. (Cross-section, see fig. 3(a); span 10 ft. for beams 1-17 and 3 ft. 4 in. for beam 18; loading at third points.)

Mark	<i>b</i>	<i>d</i>	<i>c_u</i> *	<i>t_u</i>	Wires†		Failure‡ moment in.-tons	$R = \frac{M_m \S}{bd^2c_u}$
					top	bottom		
	in.		lb./in. ²	tons/in. ²	number			
1	2.5	8.13	7,000	140	11	45	136.0	0.264
2	2.5	8.21	7,430		9	36	174.6	0.321
3	2.5	8.13			8	31	152.6	0.285
4	2.63	8.13			6	27	147.2	0.271
5	2.56	8.13			8	32	146.8	0.269
6	2.56	8.23		9,100	8	31	126.4	0.189
7	2.56	8.12	8		29	123.4	0.185	
8	2.53	8.0	7		27	119.4	0.179	
9	2.59	8.1	7		25	107.4	0.161	
10	2.50	8.25	8,260		9	35	152.0	0.250
11	2.60	8.26		9	33	149.8	0.247	
12	2.56	8.20		10	39	164.4	0.271	
13	2.56	8.19		10	37	152.4	0.251	
14	2.50	8.13		11	44	180.4	0.297	
15	2.56	8.06		11	42	154.8	0.255	
16	2.50	8.06		10	41	164.4	0.271	
17	2.50	8.06		10	39	164.6	0.272	
18	2.50	8.06		10	39	152.0	0.254	

* Concrete strength on 4-in. cubes.

† All wires were of 0.08 in. diameter; initial prestress for the individual beams varying between 76.6 and 81.7 tons/in.²

‡ The bending moment, due to dead load, of 1.7 in.-tons must be added to these values.

§ These values include the bending moment due to dead load of beam and the influence of the residual tension in top steel at failure.

TABLE II

Data obtained from Prof. A. L. L. Baker regarding tests carried out by Mr. S. Revesz at the Imperial College of Science in London. (Cross-section, see fig. 3(b); span 14 ft.; loading at third points.)

Mark	Group	b^*	d	d'	c_u †	Number of Wires‡	p_i	Failure¶ moment	At failure	
		in.							lb./in. ²	tons/in. ²
K	Ia Fig. 3(b)i	3.00	5.03	0.55	7,840	8	83.58 to 84.44	38.56	—	—
A		2.92	4.61		7,820	12		0		
B		2.91	4.85		7,820		55.3			
E		2.88	5.00		7,650		51.38			
H		2.93	4.77		7,840	52.4	57.82			
D	Ib Fig. 3(b)ii	4.25	6.92	3.16	4,010	12	84.44	74.40	—	—
C			6.72		3,090	12	84.44	92.04		
			6.05		2§	45.8				
F	II Fig. 3(b)iii	21.5	7.74	4.00	2,280	12	92	107.88	0.407	0.567
M			6.96	2.56	2,240			93.32	0.195	0.702
L			7.46	3.35	6,560			107.88	0.42	0.81
G			7.01	2.62	5,560			52.4	99.48	0.304
J			7.78	3.25	3,720	8	84.4	69.14	0.29	0.76

* The width b in Group Ia is obtained if the co-operation of the top reinforcement A'_t is taken into account, based on strain measurements.

† Concrete strength on 6-in. cubes.

‡ The number of wires relates to the bottom reinforcement. In each beam two top wires were provided. The wire is throughout 12-gauge (area per wire 0.0087 in.²) of a strength of 132 tons/in.² and bonded except for beam C (see next note).

§ In addition to twelve bonded wires, as specified above, two non-bonded wires 0.2 in. diameter of a strength of 107 tons/in.² were provided.

|| The initial prestress in the two top wires was equal to that in the bottom wires. The prestress was transferred when the concrete strength was approximately 5,500 lb./in.²

¶ Failure in all cases occurred owing to fracture of tensile wire, except for beams C and E (crushing of concrete) and J (horizontal shear).

being shown in figs. 3(c) and 3(d) respectively. Furthermore, two types of slabs according to fig. 3(e) are included as tested for British Railways.¹³ Particulars of the slabs S I and S II have not yet been printed but were given by the author in a lecture.¹³ These tests relate to 9-ft. long members loaded as cantilevers at both sides 9 in. away from the ends and supported at two points each 9 in. from the centre. The tensioned reinforcement consisted of eight wires 0.2 in. diameter placed in groups of four in grooves which were later filled with cement mortar, Magnel-Blaton anchorages being provided at the ends. Each slab S I and S II contained four untensioned wires in the compression zones and four additional tensioned wires were provided in the tensile zone of S II. It may be pointed out that S 2 also contained untensioned wires, as proposed by the author when suggesting partial prestressing.^{23, 30}

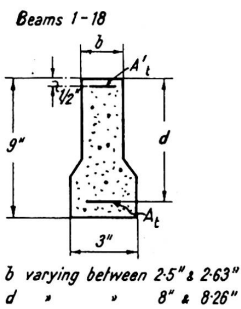

b varying between 2.5" & 2.63"
 d " " 8" & 8.26"
 • TESTS LEEDS 1950 +
 Fig. 3(a)

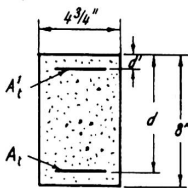

SWISS TESTS ♦
 Fig. 3(c)

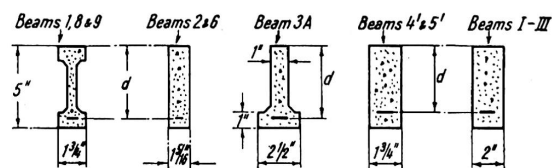

TESTS BRIXTON 1950/51 X
 Fig. 3(d)

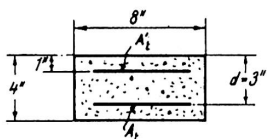

TEST BRITISH RAILWAYS
 EASTERN REGION +

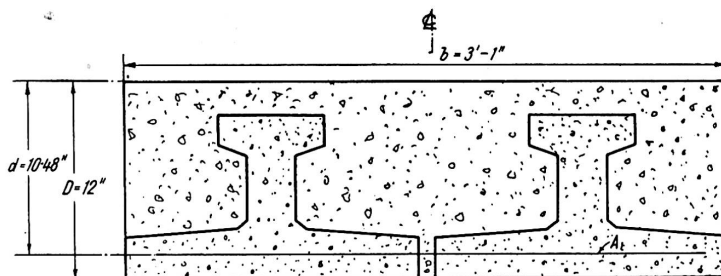

S2
 FATIGUE TEST - RAILWAY EXECUTIVE +
 Fig. 3(e)

TABLE III
Tests of Stott, Leeds (see Table I)

Mark	p	Q	$v = \frac{t_u}{200c_m^*}$	$\frac{p}{\bar{p}}$	R	$2vp(1 - vp)$	J
	%	lb./in. ²					
1	1.11	1,850	0.304	1.42	0.377	0.428	0.775
2	0.875	2,320		1.064	0.459	0.340	1.17
3	0.762	2,070		1.028	0.407	0.356	1.13
4	0.630	1,900		0.764	0.387	0.309	1.18
5	0.768	1,940		0.956	0.384	0.359	1.05
6	0.735	1,640	0.202	0.620	0.270	0.261	0.985
7	0.697	1,645		0.592	0.264	0.252	1.03
8	0.667	1,658		0.560	0.255	0.240	1.085
9	0.595	1,420		0.504	0.230	0.220	1.01
10	0.85	2,016	0.232	0.79	0.356	0.317	1.22
11	0.77	1,900		0.71	0.352	0.294	1.12*
12	0.93	2,150		0.86	0.387	0.338	1.27
13	0.98	2,000		0.82	0.359	0.326	1.06
14	1.08	2,470		1.0	0.425	0.375	1.125
15	1.02	2,090		0.944	0.364	0.360	1.01
16	1.02	2,280		0.944	0.387	0.360	1.11
17	0.97	2,280		0.900	0.385	0.348	1.25
18	0.97	2,100		0.900	0.363	0.348	1.15

* $c_m = 0.7 c_u$.

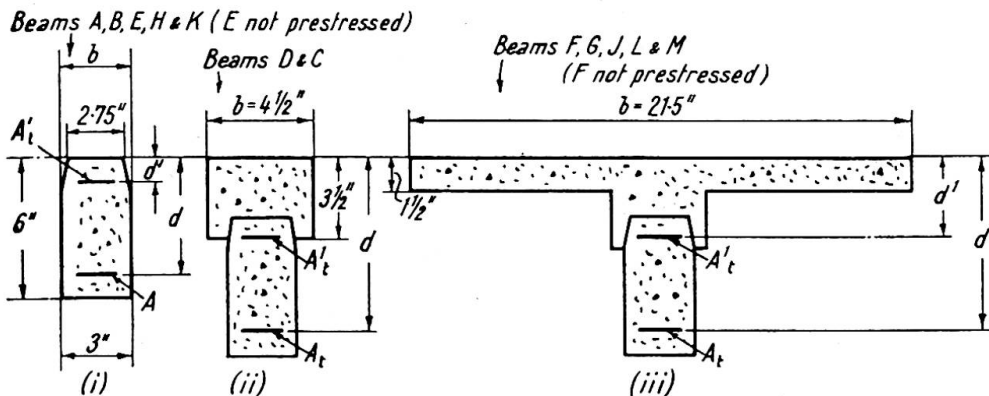

TESTS IMPERIAL COLLEGE
1949/50

Fig. 3(b)

TABLE IV
Tests of Revesz, Imperial College (see Table II)

Mark	p	Q	ν †	p/\bar{p}	R	$2\nu p(1-\nu p)$	J
	%	lb./in. ²					
K	0.461	1,140	0.314	0.579	0.243	0.248	0.978
A	0.776	1,780		0.976	0.378	0.369	1.025
B	0.740	1,810		0.932	0.384	0.355	1.084
E*	0.724	1,595	0.322	0.932	0.348	0.357	0.976
H	0.747	1,940	0.314	0.940	0.356	0.359	1.145
D	0.355	818	0.613	0.87	0.339	0.341	0.996
C	0.605	1,160	0.740	1.764	0.614	0.493	1.25
F*	0.0714	208	1.078	0.288	0.148	0.136	1.04
M	0.0835	229	1.097	0.366	0.171	0.167	1.02
L	0.079	231	0.375	0.118	0.059	0.057	1.02
G	0.0815	239	0.443	0.145	0.072	0.070	1.03
J	0.0507	143	0.660	0.133	0.065	0.064	1.01

* Non prestressed.

† $c_m = 0.6 c_u$.

TABLE V
Swiss tests (Section, see fig. 3(c))

Mark	p	Q	ν	p/\bar{p}	R	$2\nu p(1-\nu p)$	J	c_m	t^u
	%	lb./in. ²						lb./in. ²	
I	0.5	1,175	0.233	0.446	0.235	0.206	1.14	5,000	233,000
III		1,050			0.210	0.200	1.02		
VII		995			0.221	0.215	1.04		
IV	0.394	850	0.219	0.346	0.170	0.158	1.08	5,000	219,000
V		800			0.160	0.158	1.02		
VI		605			0.151	0.193	0.785		
VIII	0.222	618	0.275	0.244	0.124	0.114	1.08	5,000	275,000
IX	0.0975	296	0.306	0.119	0.066	0.052	1.14	4,500	

TABLE VI

Tests at Brixton School of Building (Section, see fig. 3(d), $t_u=138$ tons/in.²)

Mark	p	Q	v	p/\bar{p}	R	$2vp(1-vp)$	J	c_m
	%	lb./in. ²						lb./in. ²
1	0.22	641	0.386	0.340	0.160	0.155	1.03	4,000
2	0.29	402		0.448	0.200	0.199	1.01	
3A	1.58	885		2.40	0.495	0.480	1.03	
4'	0.60	1,432		0.928	0.358	0.356	1.01	
4A	0.47	1,212		0.726	0.303	0.297	1.02	
6	0.27	786		0.418	0.201	0.187	1.05	
8*	0.22	461		0.34	0.114	0.155	0.735	
9		625			0.156		1.00	
I*	0.224	433	0.341	0.306	0.096	0.141	0.68	$\frac{2}{3} \times 6,800$
II		765		0.169			1.23	
III	0.50	1,390	0.288	0.576	0.256	0.247	1.05	$\frac{2}{3} \times 8,040$

* Wires non-bonded.

TABLE VII

Tests of British Railways (Section S2, see fig. 3(e); Section S I and S II, see fig. 3(e))

Mark	p	Q	v	p/\bar{p}	R	$2vp(1-vp)$	J	c_m	t_u	Notes
	%	lb./in. ²						lb./in. ²	lb./in. ²	
S2	0.483	942	1.735	0.334	0.153	0.153	1.005	6,150	213,000	After fatigue loading
SI	1.05	1,866	0.224	0.940	0.373	0.359	1.037	5,000	224,000	Eight tensioned wires 0.2 in. dia.
SII	1.57	2,653		1.412	0.532	0.360	1.03			Eight tensioned plus four untensioned wires 0.2 in. dia.

TABLE VIII

Tests on spun-concrete tubes (Section, fig. 4(a), $t_u=65,000$ lb./in.², $c_m=8,000$ lb./in.²)

Mark	p	Q	v	p/\bar{p}	R	$2vp(1-vp)$	J	Notes
	%	lb./in. ²						
9b	0.38	445	0.0406	0.06	0.056	0.030	1.83	Tubular Beams
7a	1.26	910		0.20	0.114	0.097	1.175	
10b	1.92	1,280		0.31	0.160	0.144	1.115	
13b	0.61	620		0.10	0.078	0.049	1.605	Inverted tubular T. beams
14a	2.15	1,550		0.35	0.194	0.160	1.215	

TABLE IX

Tests on rectangular beams, Vienna (Section, fig. 4(b))

Mark	p	Q	v	p/\bar{p}	R	$2vp(1-vp)$	J	t_y	c_u^*
	%	lb./in. ²						lb./in. ²	
22	0.38	502	0.0850	0.128	0.0895	0.0619	1.44	95,000	8,400
23	0.84	911	0.0775	0.26	0.163	0.122	1.34	87,000	
24	1.47	1,375	0.0811	0.476	0.246	0.210	1.17	91,000	
4	0.39	378	0.346	0.54	0.280	0.234	1.175	95,000	2,060
5	0.84	480	0.316	1.056	0.373	0.389	0.85	87,000	

$$* c_m = \frac{2}{3} c_u.$$

TABLE X

Tests of Dr. Hajnal-Konyi, 1942 (Section fig. 4(c))

Mark	p	Q	v	p/\bar{p}	R	$2vp(1-vp)$	J	c_p	t_u	Notes
	%	lb./in. ²						lb./in. ²		
20	0.214	193.8	0.208	0.174	0.108	0.083	1.25	1,800	75,000	Twisted bar, 5-gauge
25	1.19	647	0.184	0.832	0.323	0.327	0.945*	2,000	73,600	Twisted bar, $\frac{1}{2}$ -in.
27	1.19	811	0.143	0.680	0.324	0.282	1.21	2,500	71,500	
33	0.353	310	0.20	0.282	0.155	0.131	1.18	2,000	80,000	Twisted bar, 5-gauge
34	0.562	482		0.450	0.241	0.199	1.23			
31	0.750	594		0.600	0.297	0.255	1.16			
32	0.938	725		0.670	0.362	0.304	1.19			

* below 1.0, since bars under-twisted

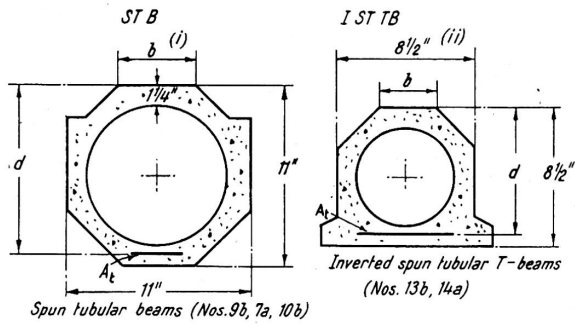

Spun tubular beams (Nos. 9b, 7a, 10b)

Inverted spun tubular T-beams (Nos. 13b, 14a)

TESTS ON SPUN CONCRETE SPECIMENS REINFORCED WITH I STEG STEEL *

Fig. 4(a)

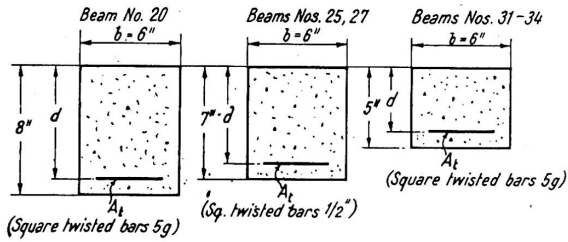

(Square twisted bars 5g)

(Sq. twisted bars 1/2")

(Square twisted bars 5g)

TESTS DR. HAJNAL-KONYI 1943 *

Fig. 4(c)

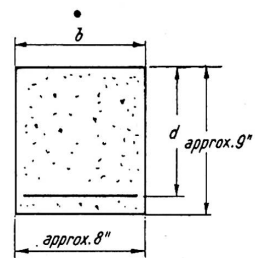

TESTS ON RECTANGULAR BEAMS REINFORCED WITH HIGH STRENGTH STEEL (Nos. 4, 5, 22, 23 & 24) *

Fig. 4(b)

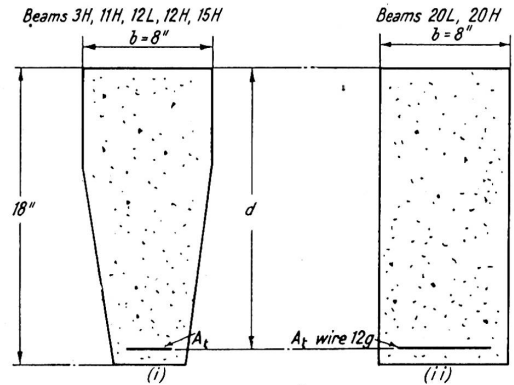

(Various types of work hardened steel)

TESTS DR. HAJNAL-KONYI 1951 *

Fig. 4(d)

Fig. 4 relates to ordinary reinforced concrete; fig. 4(a) refers to the author's tests on spun-concrete tubular beams,³ fig. 4(b) to the author's tests on rectangular beams,² and figs. 4(c) and 4(d) to Dr. Hajnal-Konyi's tests^{4, 5} respectively.

TABLE XI
Tests of Dr. Hajnal-Konyi, 1951 (Section, fig. 4(d))

Mark	p	Q	v	p/\bar{p}	R	$2vp(1-vp)$	J	c_u	t_u	t_y	Notes
	%	lb./in. ²						lb./in. ²			
3H	0.608	396	0.0873	0.213	0.096	0.100	0.95	6,200	72,130	—	Square twisted bar, $\frac{7}{8}$ in. dia.
			0.0760	0.185		0.088			1.09	—	
11H	0.584	447	0.1043	0.244	0.111	0.115	0.97	6,050	84,220	—	Tor steel 1 in. dia.
			0.0875	0.205		0.097			1.11	—	
12L	0.505	417	0.1736	0.393	0.170	0.177	0.97	3,230	85,300	—	Indented twisted bar 1 in.
			0.1490	0.337		0.154			1.10	—	
12H	0.570	461	0.1168	0.266	0.121	0.124	1.015	5,760	86,000	—	
			0.0997	0.227		0.107			1.165	—	
15H	0.580	456	0.1113	0.258	0.121	0.121	1.00	5,890	83,600	—	American ribbed type, twisted 1 in.
			0.0935	0.217		0.103			1.19	—	
20L	0.178	456	0.478*	0.340	0.163	0.155	1.05	3,990*	268,000	—	High-tensile wire
20H	0.180	491	0.355*	0.256	0.130	0.120	1.09	5,400*			

* $c_m = 0.7 c_u$.

The investigation of these test results with regard to the presented formulae is shown in Tables III–XI. It is obviously of greatest importance to select the right value c_m when calculating v , assuming that t_u is accurately known, which will be the case generally. In the tests in fig. 3(a) a ratio $G = c_m/c_u = 0.7$ has been taken into account, while with regard to the tests in fig. 3(b) $G = 0.6$ is still rather on the low side. If the wire fractures in a certain case, it must be expected that J is not less than unity. Hence for $J = 1$, the corresponding value v and thus c_m can be computed, resulting

in $c_m = \frac{(t_u p)^2}{200(t_u p - 100 Q)}$ which results for beam K, in $c_m = 3,980$ lb./in.² which would have corresponded to a ratio $G = 0.515$ instead of 0.6 as taken into account. In the case of the Swiss tests, the concrete strength was not known accurately, but from the fact that in specimen III the wires fractured and the steel strength was given, it was possible to assume c_m . In the Brixton and British Railways tests the published prism strength values have been taken into account. For the spun-concrete tubular beams $c_m = 8,000$ lb./in.² has been assumed in view of the extraordinary strength properties of these specimens and the ultimate strength of the Isteg steel has been considered, although there was a distinct yield point of this reinforcement. Nevertheless

an extraordinary excess over unity was obtained for the ratio J . The high-strength steel used in the rectangular beams tested by the author had a distinct yield point, and this stress and two-thirds of the concrete cube strength were taken in analysing the results. In Dr. Hajnal-Konyi's tests the published prism strength values have been used, except for 20L and 20H, when 70% of the cube strength as with the Stott tests has been used. For the specimens (fig. 4(d)i) the ultimate strength and the yield point stress have been investigated. The examples (fig. 4(d)ii) were not included in the paper⁵ but were given during its presentation and published in *Magazine of Concrete Research* in March, 1952.

The results evaluated in the Tables III–XI have been plotted in charts figs. 5–7.

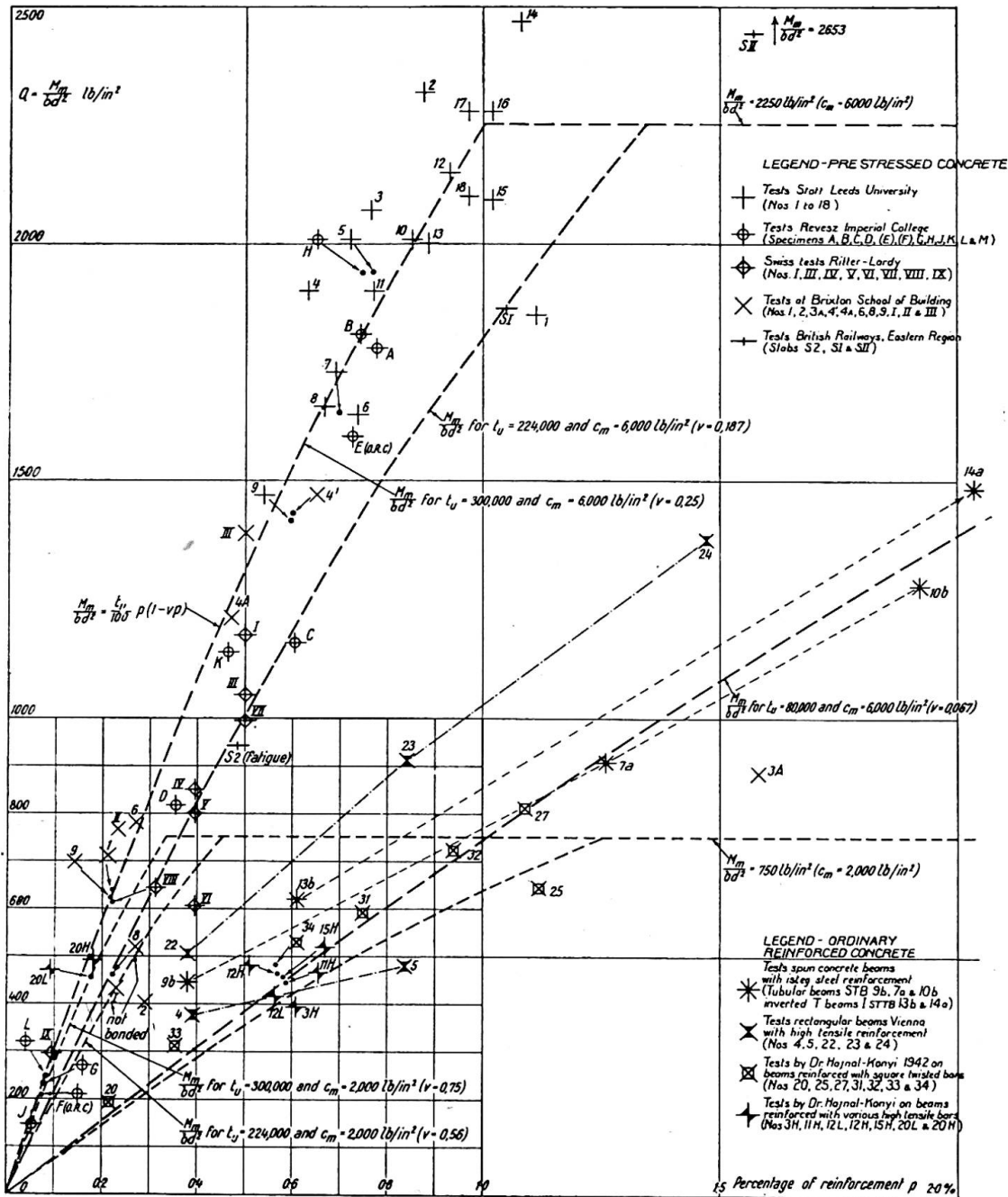

Fig. 5

Fig. 5 shows the relation between the percentage p and the stress $Q = M_m / (bd^2)$. In addition to test results theoretical values have been plotted for $t_u = 80,000$, and $224,000$ and $300,000$ lb./in.², and in each case two concrete values have been distinguished: $c_m = 2,000$ and $6,000$ lb./in.² According to fig. 1 the value for balanced design for a low stress, such as $c_m = 2,000$ lb./in.² would be rather higher than $c_m/3$. In figs. 6 and 7 prestressed and ordinary reinforced concrete are separated. Fig. 6 indicates how far the concrete strength is utilised, while fig. 7 shows the exploitation of the steel strength in exaggerated presentation, a difference of 5% appearing as a great deviation. The chart fig. 6 has been plotted in such a way that the abscissa represents $2vp(1-vp)$, while the ordinate is R ; thus a straight line between the origin and $R = 2vp(1-vp) = 0.375$ is obtained. In fig. 7 the values of J are plotted against p/\bar{p} . A very good agreement between the minimum values indicated in figs. 6 and 7 and the actual

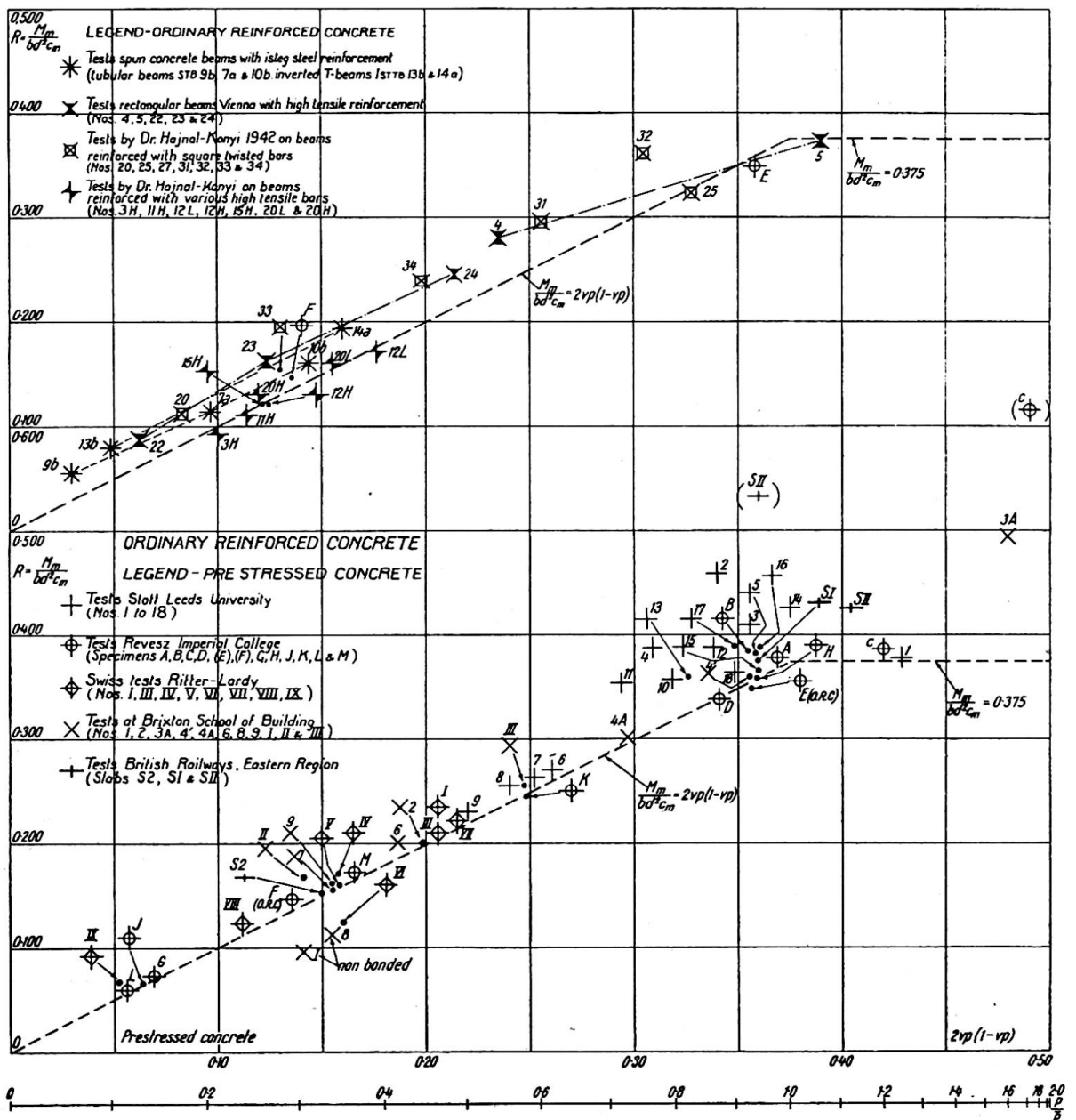
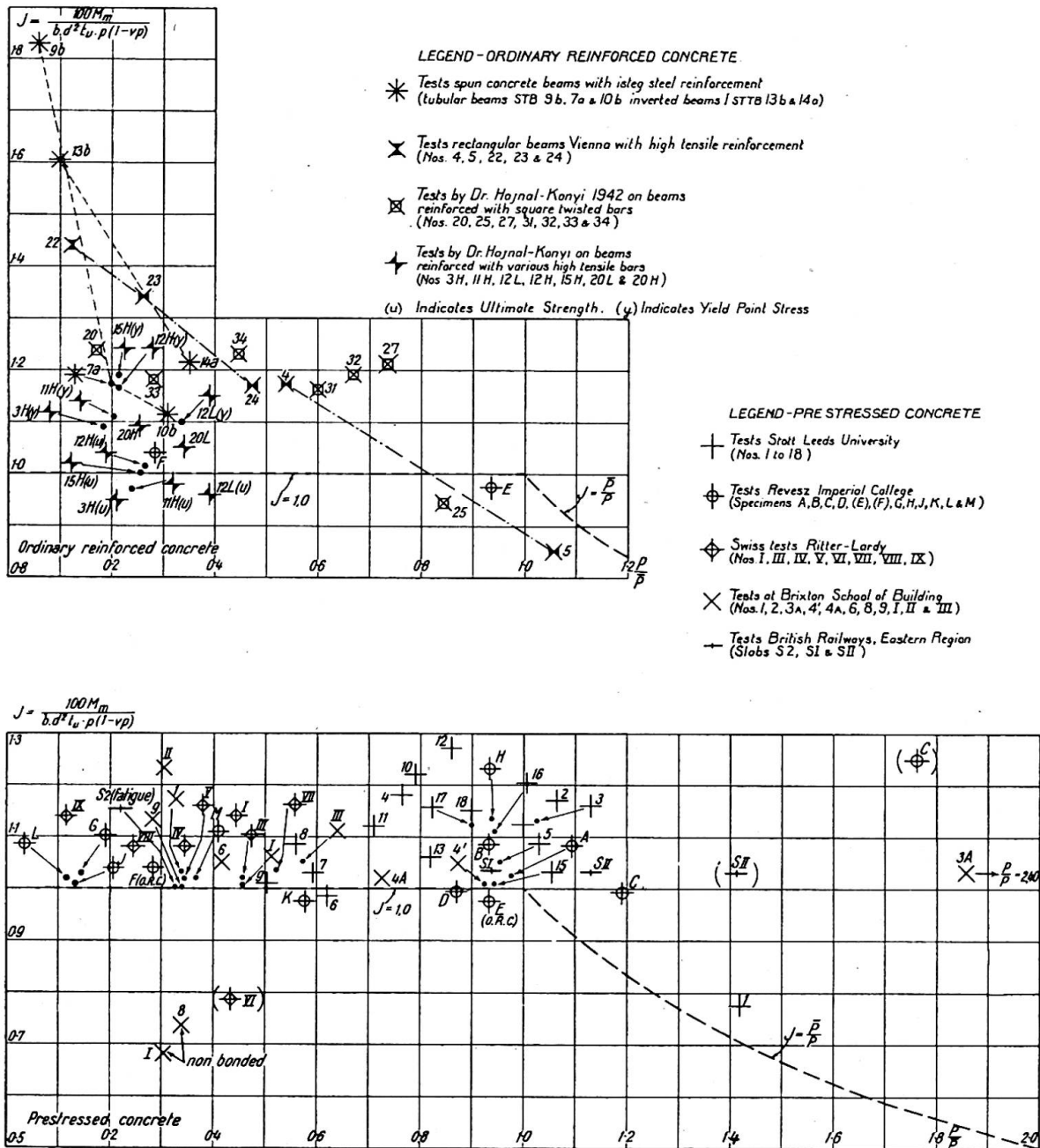

Fig. 6 (Note:—the point 27 is not shown)

values is seen, and it can be concluded that safe values are obtained if G is assumed as 0.6.

However, there are a few points which require further discussion. The slab S II of the British Railways and the beam C of the Imperial College show very high values of R , much exceeding the expected limit of 0.375. In the first case the reason is that the compressive reinforcement consisting of four untensioned high-strength wires has not been taken into account in Table VII. However, when considering a nominal width of 10 in., corrected values are obtained as plotted in figs. 6 and 7 in addition to the original values, indicated by brackets. The values for beam C have been obtained from $c_m = 0.6 \times 3,090 = 1,854 \text{ lb./in.}^2$, a very low value, resulting in $R = 0.614$, which seems to be an impossible value and must be excluded. It must be assumed that



the concrete strength was higher than stated in Table II. However, if a value $c_m=3,000$ lb./in.² is taken into account, a quite reasonable value for R is obtained, as seen from the diagram. It may be mentioned that this beam C contained bonded and additional non-bonded tensioned wires. Apparently this co-operation is quite successful, while the ultimate resistance is much less with beams with only non-bonded wires, as seen from specimens 8 and I of the Brixton tests. The behaviour of beams with non-bonded wires requires further study. Further tests have been carried out at the Imperial College and it is hoped results will be available to enable the author to supplement this study. It may be added that Prof. R. H. Evans was probably the first to point out the difference between the behaviour of bonded and non-bonded wires.³¹

Like the two beams with non-bonded wires the beam VI of the Swiss tests had a relatively low ultimate resistance. In this case the initial tensioning stress was about 50,000 lb./in.² and only a small prestress may have remained effective after all losses had taken place. However, this cannot be taken as an explanation for a reduced ultimate resistance, since the present study has proved that beams with untensioned high-strength wires (E and F of tests by Revesz and 20L and 20H of tests by Dr. Hajnal-Konyi) reached approximately the same high values as prestressed beams. Moreover there are two beams with lower prestress among the tests by Revesz, i.e. G and H, which show no appreciable difference from the other results with high prestress, although one approached the balanced design. It seems therefore reasonable to exclude the test result VI of the Swiss tests. This may be also justified by the fact that for this test the lowest cracking load was obtained, but it would be very important for similar tests to be carried out to check this question.

It was previously mentioned that slab S2 was statically tested to failure after a fatigue test extended over three million repetitions. It may be pointed out that bonded 0.2-in. wire was provided and this test has proved the complete efficiency of this wire, although it was considered from tests³² that wire of such a large diameter is not suitable. Apparently it depends greatly on the surface conditions, and the British wire of 0.2 in. diameter is suitable.

In conclusion it can be said that the tests presented have proved that generally the same conditions apply with regard to ultimate resistance to prestressed and non prestressed members. The modified simple formulae for ultimate resistance have shown a very good agreement with test values and when assessing the ultimate resistance safe results are obtained if a low stress c_m is taken, e.g. $0.6 c_u$. The two charts, figs. 6 and 7, permit the separate investigation of concrete and steel resistance. This investigation is limited to bonded reinforcement and further research is necessary on the behaviour of non-bonded tensioned steel. In this case a reduction factor of, say, 0.60 to 0.80 will have to be considered and particulars will be shown in a supplement.

ACKNOWLEDGEMENTS

The author would like to express his thanks to the Railway Executive and the Civil Engineer of the Eastern Region for the facilities granted to him when preparing this paper.

REFERENCES

- (1) ABELES, P. W. "Ueber die Verwendung hochwertiger Baustoffe im Eisenbetonbau" (On the Use of High-Strength Materials in Reinforced Concrete), *Beton u. Eisen*, Nos. 8 and 9, 1935.

- (2) ABELES, P. W. "Versuche mit Rechtecksbalken, bewehrt mit besonders hochwertigem Stahl" (Tests on Rectangular Beams Reinforced with Steel of Specially High Strength), *Beton u. Eisen*, Nos. 17 and 18, 1937.
- (3) ABELES, P. W. "Spun Tubular Beams. Economy in Steel in Floor Construction," *Concrete and Constr. Engr.*, May, 1940.
- (4) HAJNAL-KONYI, K. "Tests on Square Twisted Steel Bars and their Application as Reinforcement of Concrete," *Struct. Engr.*, September, 1943.
- (5) HAJNAL-KONYI, K. "Comparative Tests on Various Types of Bars as Reinforcement of Concrete Beams," *Struct. Engr.*, May, 1951.
- (6) EVANS, R. H. "Extensibility and Modulus of Rupture of Concrete," *Struct. Engr.*, December, 1946.
- (7) THOMAS, F. G. "Cracking in Reinforced Concrete," *Struct. Engr.*, July, 1936.
- (8) ABELES, P. W. "Die Rostgefahr von Eisenbetonkonstruktionen bei Rissbildung" (The Danger of Corrosion in Reinforced-Concrete Constructions at Cracking), *Zement*, Nos. 7-9, 1937.
- (9) EISENMANN. "Untersuchung der Rissbildung des Betons mit Ultraschall" (Investigation of Cracking in Concrete by Means of Supersonic Pulse), *Beton und Stahlbetonbau*, January, 1951.
- (10) "Report on Pre-stressed Concrete Sleepers Tested as Simply Supported Beams," *Concrete and Constr. Engr.*, April and May, 1947.
- (11) ABELES, P. W. "Further Notes on the Principles and Design of Pre-stressed Concrete," *Civil Eng. (L)*, October, 1950.
- (12) "First Report on Pre-stressed Concrete," *Instn. of Struct. Engrs.*, September, 1951.
- (13) ABELES, P. W. "Some New Developments in Pre-stressed Concrete," *Struct. Engr.*, October, 1951.
- (14) ABELES, P. W. "Elastizität des Betons" (Elasticity of Concrete), *Zement*, Nos. 37, 38 and 40, 1937.
- (15) EVANS, R. H. "The Plastic Theories for the Ultimate Strength of Reinforced-Concrete Beams," *J. Instn. Civ. Engrs.*, December, 1943.
- (16) HAJNAL-KONYI, K. "The Modular Ratio. A new method of design omitting m ," *Concrete and Constr. Engr.*, January, February, and March, 1937.
- (17) ABELES, P. W. "Neuere Entwicklungen im Stahlbetonbau" (New Developments in Reinforced Concrete), *Oesterreichische Bauzeitschrift*, Nos. 1/3, 1948.
- (18) BAKER, A. L. L. "Recent Research in Reinforced Concrete and its Application to Design," *J. Instn. Civ. Engrs.*, February, 1951.
- (19) KING, J. W. H. "The Design of Pre-stressed Concrete Beams from Fundamental Principles," *Concrete and Constr. Engr.*, September, 1950.
- (20) GRANHOLM, HJALMAR. "Modern Developments in Reinforced Concrete Design and the Influence of Research," Building Research Congress, London, 1951.
- (21) WHITNEY, CHARLES S. "Plastic Theory of Reinforced Concrete Design," *Trans. Amer. Soc. Civ. Engrs.*, Paper 2133 (published December, 1940).
- (22) COX, KENNETH C. "Tests of Reinforced Concrete Beams with Recommendations for Attaining Balanced Design," *J. Amer. Concrete Inst.*, September, 1941.
- (23) ABELES, P. W. "Fully and Partly Pre-stressed Reinforced Concrete," *J. Amer. Concrete Inst.*, January, 1945.
- (24) ABELES, P. W. *Principles and Practice of Pre-stressed Concrete*, Crosby, Lockwood & Son Ltd., London, 1949; F. Ungar Publ. Ltd., New York, 1949.
- (25) ABELES, P. W. "Further Notes on the Principles and Design of Pre-stressed Concrete," *Civ. Eng. (L)*, August, 1950.
- (26) EVANS, R. H. "Research and Development in Pre-stressing" (Unwin Lecture), *J. Instn. Civ. Engrs.*, February, 1951.
- (27) RITTER, M., and LARDY, P. *Vorgespannter Beton* (Prestressed Concrete), Gebr. A. Lehmann & Co., Zurich, 1946.
- (28) ABELES, P. W., and HOCKLEY, C. H. "Small Scale Demonstration Tests on Pre-stressed Concrete Beams," *Struct. Engr.*, June, 1950.

- (29) ABELES, P. W. "The Ultimate Resistance of Pre-stressed Concrete Beams," *Concrete and Constr. Eng.*, October, 1951.
- (30) ABELES, P. W. "Saving Steel by Pre-stressing," *Concrete and Constr. Eng.*, July, 1940.
- (31) EVANS, R. H. "Relative Merits of Wire and Bar Reinforcement in Pre-stressed Concrete," *J. Instn. Civ. Engrs.*, February, 1942.
- (32) E. M. P. A. Bericht No. 155, "Vorgespannter Beton" (Report No. 155, Prestressed Concrete), Zurich, 1946.

Summary

The behaviour of concrete beams with high-strength reinforcement (including work-hardened steel) is investigated on the basis of various test results. Cracking is discussed and the resilience of prestressed concrete pointed out. Fatigue tests have shown that cracks which opened one million times closed entirely on removal of the load. The main study of the paper is devoted to ultimate load conditions. Formulae for the design are employed which allow a simple assessment of the ultimate resistance. These formulae are based on a rectangular stress distribution of the maximum concrete compressive stress c_m over a maximum depth of $0.5 d$, resulting in a maximum resistance $M_{max} = 0.375 b d^2 c_m$. If this stress is taken as $0.6 c_u$, a safe approximation of the ultimate resistance is obtained. The percentage for the balanced design \bar{p} amounts to $0.25/\nu$, where $\nu = t_u/200 c_m$. The ultimate steel strength t_u is normally reached but must in certain cases be replaced by the yield-point stress t_y . Three charts are shown for the various test results. One contains the stress $Q = M_m/(bd^2)$, the other the stress-ratio $R = Q/c_m$, and the third the stress-ratio $J = t_m/t_u$. This gives a measure of the co-operation of the concrete tensile zone between the cracks and indicates the quality of adhesion between steel and concrete. The investigation has shown that the high-strength properties of steel and concrete can be fully exploited, both in prestressed and ordinary reinforced concrete, provided that efficient bond is ensured. If the reinforcement is not efficiently bonded, M_{max} , Q , R , and J are appreciably reduced and reduction factors must be considered.

Résumé

L'auteur étudie, sur la base de divers résultats expérimentaux, le comportement des poutres en béton armées avec de l'acier à hautes résistances, y compris l'acier écroui. Il aborde sommairement la question de la formation des fissures et attire particulièrement l'attention sur l'élasticité du béton précontraint. Des essais de fatigue ont montré que des fissures qui s'ouvraient sous une charge appliquée 1 000 000 fois se refermaient complètement au moment de la suppression de la charge.

La partie principale du présent rapport traite de la question de la rupture elle-même. L'auteur emploie des formules simplifiées pour la détermination approchée du moment de rupture. Ces formules sont basées sur une répartition rectangulaire de la contrainte maximum calculée dans le béton σ_{bmax} sur une hauteur maximum de $0,5 h$, ce qui donne un moment maximum $M_{max} = 0,375 b h^2 \sigma_{bmax}$. En admettant pour σ_{bmax} 60% de la résistance de cube W , on obtient pour le moment de rupture des valeurs approchées du côté correspondant à la sécurité. L'armature limite pour laquelle la rupture se produit par destruction soit du béton, soit de l'acier, est définie par $\mu_g = 0,25/\nu$ avec $\nu = \sigma_{eB}/200\sigma_{bmax}$ en désignant par σ_{eB} la charge de rupture de l'acier, qui doit être ici remplacée dans certains cas par sa limite écoulement σ_{eF} .

Trois diagrammes mettent en évidence les résultats fournis par les essais. Ces diagrammes donnent :

la contrainte $Q = M_{max}/(bh^2)$

le taux de contrainte $R = M_{max}/(bh^2\sigma_{bmax})$

le taux des contraintes dans l'acier $J = \sigma_{emax}/\sigma_{eB}$, c'est-à-dire le rapport entre la contrainte calculée dans l'acier, pour une section de rupture et la charge de rupture de l'acier.

On obtient ainsi une mesure du degré de coopération entre le béton et l'acier, entre les fissures, ainsi qu'une mesure de l'adhérence entre ces deux éléments. Les recherches ici exposées ont montré que, sous réserve d'une bonne adhérence, les caractéristiques de résistance mécanique de l'acier et du béton sont pleinement utilisées, aussi bien dans le béton armé ordinaire que dans le béton précontraint. Si l'acier n'a pas une bonne adhérence M_{max} , Q , R et J sont réduits considérablement et l'utilisation des facteurs de réduction doit être considérée.

Zusammenfassung

Das Verhalten von mit hochwertigem (einschliesslich verdrilltem) Stahl bewehrten Betonbalken wird an Hand verschiedener Versuchsergebnisse untersucht. Die Rissbildung wird kurz behandelt und es wird auf die Elastizität von vorgespanntem Beton besonders hingewiesen. Ermüdungsversuche haben bewiesen, dass sich Risse, die sich unter wiederholter Belastung 1 000 000 mal öffneten, geschlossen haben, sowie die Last entfernt wurde. Der Hauptteil des vorliegenden Berichtes bezieht sich auf den Bruchzustand. Einfache Formeln werden verwendet, die eine angenäherte Bestimmung des Bruchmomentes ermöglichen. Diese Formeln sind auf eine rechteckige Spannungsverteilung der grössten rechnermässigen Betonspannung $\sigma_{b(max)}$ aufgebaut, die sich maximal auf die halbe Höhe h erstreckt, was ein Grösstmoment $M_{max} = 0.375 bh^2\sigma_{bmax}$ ergibt. Wenn σ_{bmax} als 60% der Würfelfestigkeit W angenommen wird, dann ergeben sich Annäherungswerte für das Bruchmoment, die auf der sicheren Seite sind. Die Grenzbewehrung, bei welcher der Bruch entweder durch Beton- oder Stahlzerstörung erfolgt, ergibt sich als $0.25/\nu$, $\nu = \sigma_{eB}/200 \sigma_{b(max)}$, wobei σ_{eB} die Festigkeit des Stahles in einzelnen Fällen durch die Streckgrenze σ_{eF} zu ersetzen ist. Drei Diagramme zeigen die Ergebnisse der Auswertung der Versuche. Eines enthält die Spannung $Q = M_{max}/(bh^2)$, das andere das Spannungsverhältnis $R = M_{max}/(bh^2\sigma_{bmax})$ und das dritte das Verhältnis der Stahlspannungen $J = \sigma_{emax}/\sigma_{eBruch}$, d.i. das der rechnermässigen Stahlspannung für einen gerissenen Querschnitt und der Stahlfestigkeit. Dies stellt den Grad der Zusammenarbeit zwischen Beton und Stahl zwischen den Rissen dar und ist ein Mass für die Haftung zwischen Beton und Stahl. Die vorliegende Untersuchung hat bewiesen dass—gute Haftung vorausgesetzt—die hohen Festigkeitseigenschaften von Stahl und Beton sowohl beim gewöhnlichen Eisenbeton als auch beim vorgespannten Beton voll ausgenützt werden. In dem Falle, dass keine zuverlässige Haftung der Bewehrung gesichert ist, werden M_{max} , Q , R , und J wesentlich kleiner und Reduktionsfaktoren müssen eingesetzt werden.

Leere Seite
Blank page
Page vide