

The behaviour of a symmetrical pitched roof portal loaded to collapse

Autor(en): **Baker, J.F. / Eickhoff, K.G.**

Objektyp: **Article**

Zeitschrift: **IABSE congress report = Rapport du congrès AIPC = IVBH
Kongressbericht**

Band (Jahr): **5 (1956)**

PDF erstellt am: **22.07.2024**

Persistenter Link: <https://doi.org/10.5169/seals-5965>

Nutzungsbedingungen

Die ETH-Bibliothek ist Anbieterin der digitalisierten Zeitschriften. Sie besitzt keine Urheberrechte an den Inhalten der Zeitschriften. Die Rechte liegen in der Regel bei den Herausgebern.

Die auf der Plattform e-periodica veröffentlichten Dokumente stehen für nicht-kommerzielle Zwecke in Lehre und Forschung sowie für die private Nutzung frei zur Verfügung. Einzelne Dateien oder Ausdrucke aus diesem Angebot können zusammen mit diesen Nutzungsbedingungen und den korrekten Herkunftsbezeichnungen weitergegeben werden.

Das Veröffentlichen von Bildern in Print- und Online-Publikationen ist nur mit vorheriger Genehmigung der Rechteinhaber erlaubt. Die systematische Speicherung von Teilen des elektronischen Angebots auf anderen Servern bedarf ebenfalls des schriftlichen Einverständnisses der Rechteinhaber.

Haftungsausschluss

Alle Angaben erfolgen ohne Gewähr für Vollständigkeit oder Richtigkeit. Es wird keine Haftung übernommen für Schäden durch die Verwendung von Informationen aus diesem Online-Angebot oder durch das Fehlen von Informationen. Dies gilt auch für Inhalte Dritter, die über dieses Angebot zugänglich sind.

Ia1

**The Behaviour of a symmetrical pitched roof portal
loaded to collapse**

**Das Verhalten eines symmetrischen Portalrahmens mit
geneigten Dachflächen bei einer Beanspruchung,
die zum Bruch führt.**

Ensaio de rotura de um pórtico simétrico de duas águas

Essai à la rupture d'un portique symétrique à deux pans

PROF. J. F. BAKER
M. A., Sc. D., M. I. C. E.

K. G. EICKHOFF
M. A., A. M. I. C. E.

Cambridge University
Cambridge

1. Introduction.

The aim of every method of design is to produce a structure which will carry the working loads safely. That is to say, the structure must be so proportioned that it will not fail until it is subjected to a load greater than the working load.

Elastic design methods [1] are based on the assumption that a structure fails when the stress anywhere reaches the elastic limit, but it is well known that redundant structures, which are composed of a ductile material and derive their strength primarily from the bending of their members, can continue to carry additional load long after this elastic limit is reached.

The Plastic Method of Design focusses attention on the real collapse load of the framework and consists in so proportioning the framework that it is on the point of collapse when subjected to the working load multiplied by a load factor. It is thus of fundamental importance that the methods of calculating the collapse loads [2, 3] shall be accurate, and these have been verified by a considerable number of small scale tests on beams and model portal frames [4, 5].

Designers are not only interested in the overall safety of their structure, but in its deflections both under the normal working loads and under various overloads. These deflections are much more difficult to calculate than the collapse loads themselves. Moreover, they cannot be predicted satisfactorily from model tests, since the behaviour of details such as joint connections or effects such as strain hardening in

the plastic hinges considerably influence the deflections, and these quantities cannot be reproduced faithfully in models.

Some experiments must therefore be carried out on full scale structures; in addition to providing information about deflections, these experiments also add strong support to the results of the model tests in verifying the plastic theory of collapse. The Pitched Roof Portal Frame, whose behaviour is described in this paper, forms one of a series of full scale frames which are being loaded to collapse as part of the investigation guiding the development of the plastic design of structures which was started in England in 1936 [6]. The results of other tests in this series have been published elsewhere [7, 8].

2. General Description of the Portal Frame and Instruments.

The frame consisted of two similar symmetrical pitched roof portals, constructed throughout of 7" \times 4" \times 16 lb. per foot Rolled Steel Joist, having a span of 16 feet, a stanchion height of 8 feet and a roof slope of $22\frac{1}{2}^\circ$. The two portals were erected 12 feet apart, and braced by two eaves beams of 6" \times 3" channel, and purlins and sheeting rails of 3" \times 1 $\frac{1}{2}$ " R. S. J. (Figs. 1 and 2). The feet of the stanchions were rigidly attached to two heavy girders, also at 12 foot centres, which were in turn bolted down to a reinforced concrete raft. The raft to girder connections were such that the raft did not apply any restraining moment to the girder and thus, since the girder was stout enough to remain elastic when subjected to the full plastic moment of the stanchions, the rotations of the stanchion feet under any applied moments could be calculated from the elastic properties of the girder.

The joints of the portals were made by cutting off the lengths of R. S. J. to the required angle, and then profile welding them to $\frac{3}{8}$ " thick division plates (Fig. 3). These division plates were flame cut. The profile welds were of $\frac{1}{2}$ " leg round the flanges, and $\frac{1}{4}$ " leg round the web. This form of joint has been used extensively throughout the whole series of portal tests, and has proved entirely satisfactory.

Vertical load was applied to the portals by a pair of steel tanks which were suspended from an 8" \times 6" R. S. J., the ends of this joist being attached to the apex of each portal (Figs. 1 and 4). As will be seen from the photograph (Fig. 4) the load was applied through a length of half round material on the underside of the 8" \times 6" R. S. J., and each frame was stiffened at this point by two pieces of $\frac{3}{8}$ " plate welded to the web and flanges of the 7" \times 4" R. S. J.

Horizontal load was applied by a second pair of tanks, each of which was suspended from a pair of steel cables passing over a large pulley held in a fixed frame (Fig. 2). The cables were attached to each portal through a heavy lug welded to the top of the stanchion (Fig. 3).

Dead load was provided in the form of weighed lengths of steel caterpillar track, and by water run in from four storage tanks. Each storage tank, holding about a ton of water, was connected to a particular loading tank by a hose line, and the increment of load was controlled by a valve in the bottom of the storage tank, and was recorded on a graduated tube.

The horizontal deflections of the tops of the stanchions were measured by verniers supported on tripods which were quite separate from the frame, these verniers being attached to the stanchions by

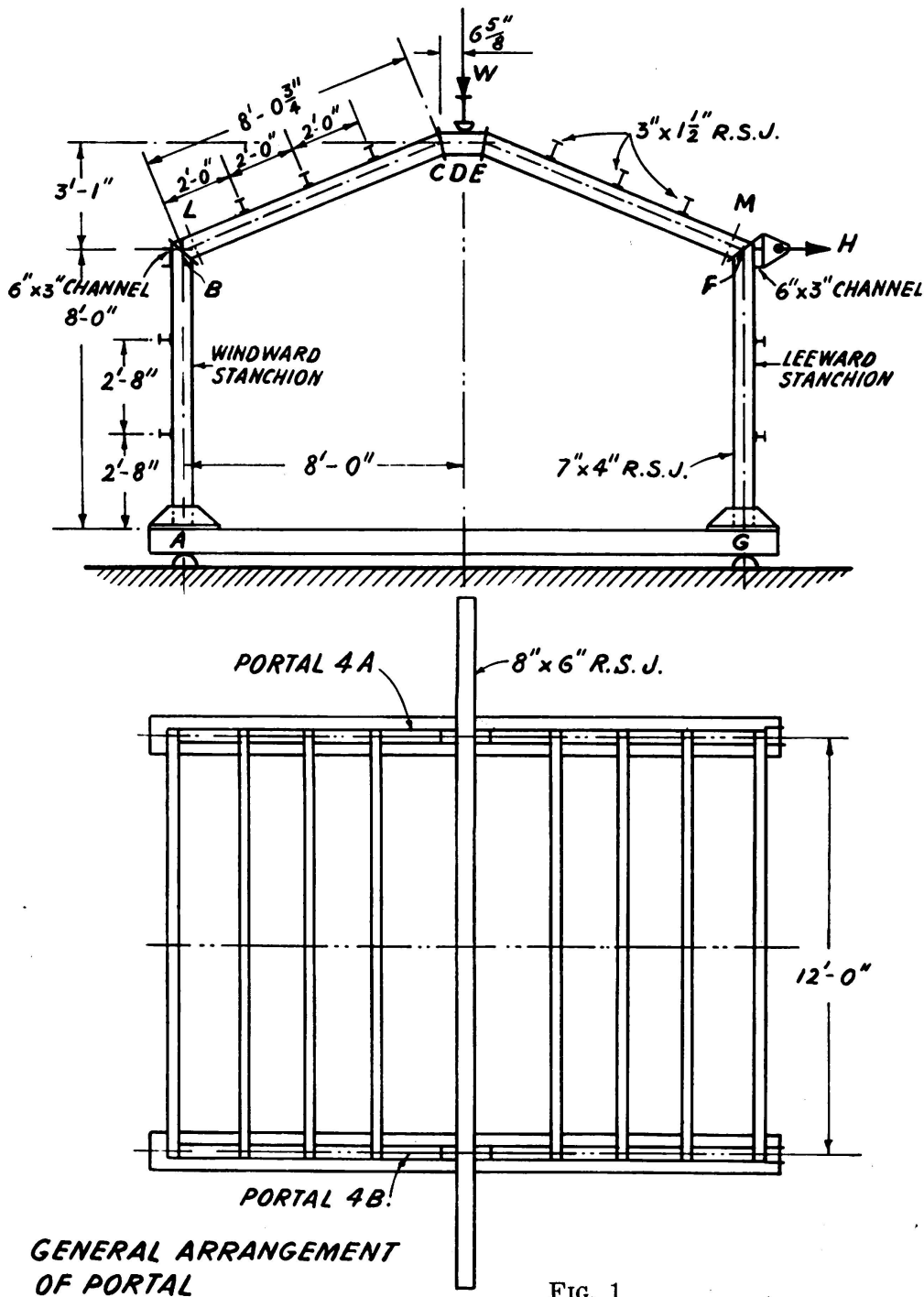

FIG. 1

fine stranded wires under tension. The tripods were placed adjacent to the windward stanchions and the wires to these stanchions were tensioned by lengths of rubber cord. The wires to the leeward stanchions, which were 17 feet long, were tensioned by 20 lb. weights suspended

over pulleys, In this way the longitudinal deflection of each stanchion was measured to an accuracy of 0.01 inches.

The vertical deflection of the apex of each portal was measured by observing, through a theodolite, the position of a steel rule suspended vertically from the apex, and the lateral deflection of the main loading

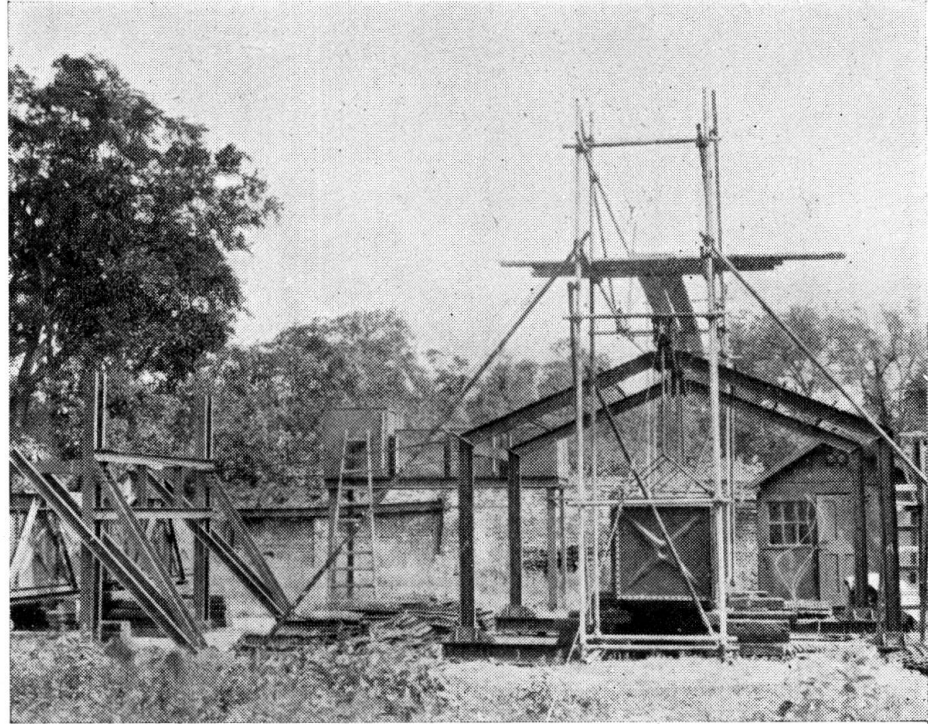

FIG. 2. Side view of frame before loading

beam was similarly measured by observing a steel rule attached to the centre of the web of the beam. Again an accuracy of 0.01 inches was obtained.

The joints A, B, D, F and G of portal 4 A were coated with plumbers resin so that some indication could be observed when plastic flow occurred at these joints.

3. *Experimental Procedure.*

(a) *Choice of Loads.*

A portal will collapse when a sufficient number of plastic hinges has formed to transform the portal into a mechanism [2]. Each different mechanism is called a mode of collapse. The mode of collapse, depends upon the ratio of side load to vertical load at collapse, and the theoretical behaviour of the particular portal under test is expressed in Fig. 5 in the form of a diagram. The portal can support any combination of horizontal and vertical loads corresponding to a point in the area between the origin and the line P Q R S, and cannot support any combination of loads corresponding to a point outside this area. Any

sequence of loading can be represented by a curve on this diagram, and when such a loading curve reaches the line P Q R S the portal will collapse in the mode corresponding to the particular portion of the line P Q R S which has been reached.

The portal was loaded in such a way that collapse according to the mode [1] would be expected. This mode corresponds to the line P Q



FIG. 3. Joint F, showing side load attachment

in Fig. 5, and has plastic hinges at the points B, D, F and G, the bottom of the windward stanchion remaining elastic. The total horizontal load, H, was applied before any of the vertical load, this being purely a matter of convenience in testing. The final choice of $H=1.70$ tons for the total horizontal load, corresponding to the vertical line shown in Fig. 5, was quite arbitrary.

It must be emphasized that it is the combination of loads at collapse which determines the mode of collapse. The order of loading should have no effect.

(b) *Description of Test.*

The application of load to the portals until collapse occurred extended over two days. Initially the supports on which the vertical and side loading tanks had been resting were removed, thus applying a small amount of vertical and side load. The side load was then increased to the required value of 1.70 tons per portal, and this load was kept unaltered throughout the remainder of the test.

Load increments of 1 ton per portal were then added to the vertical loading tanks until a total of 5.00 tons vertical load per portal was reached, when the frame was left over night. It was still within the elastic range, and only negligible creep, of the order of 0.02 inches, was observed when the deflections were re-measured in the morning.

The test was continued by applying further vertical load in increments of 1 ton per portal until a load of 7 tons per portal was obtained,

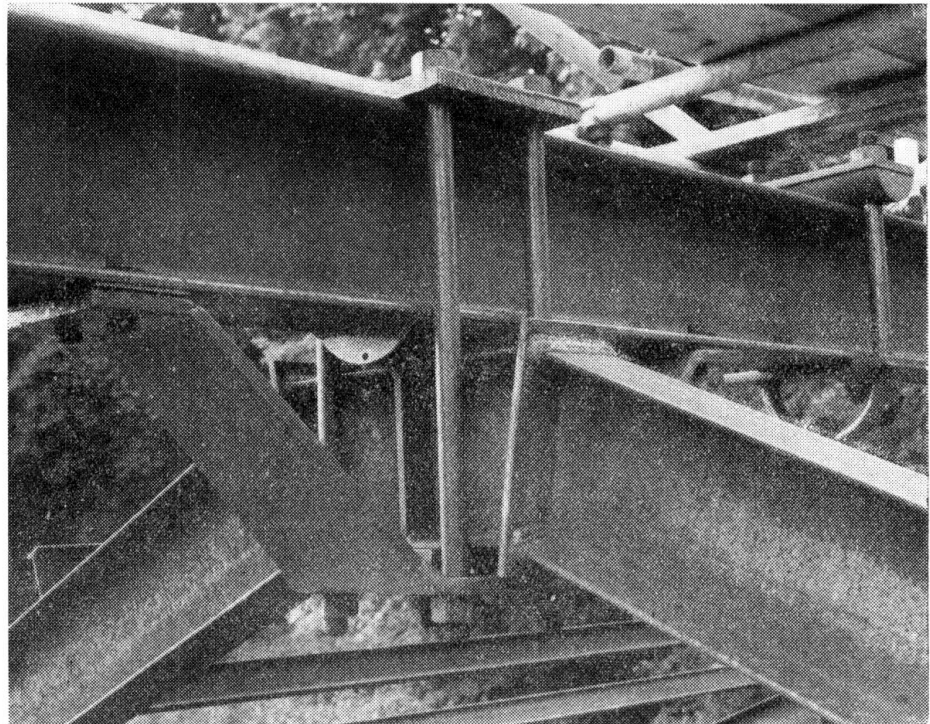

FIG. 4. Vertical load attachment

after which load was added in half ton increments until the frame collapsed at a vertical load of 14.20 tons per portal.

Considerable care was taken to ensure that the loading of both frames was carried out evenly. It is interesting to record that the lateral movement of the loading beam was very small, less than $\frac{1}{8}$ " , up to a vertical load of 13.70 tons. As a precaution against excessive sidesway during collapse, inclined cables were attached to the ends of the main loading beam, but these were left slack and remained so throughout the whole test.

In the interests of safety, the last few increments of load were put into the tanks from above, being lowered down into the tanks from steel scaffolding spanning the frame.

Final collapse of the frame occurred at a vertical load of 14.20 tons per portal. The frame supported this load for about twenty minutes, the vertical and longitudinal deflections creeping all the time, and then collapsed laterally (Fig. 6). Viewed from the leeward end, (Fig. 6) the tops of the leeward stanchions moved over to the left, while the main loading beam deflected to the right, and the vertical loading tanks

settled down on the supports prepared for them, thus preventing further deformation of the frame.

THEORETICAL COLLAPSE LOADS

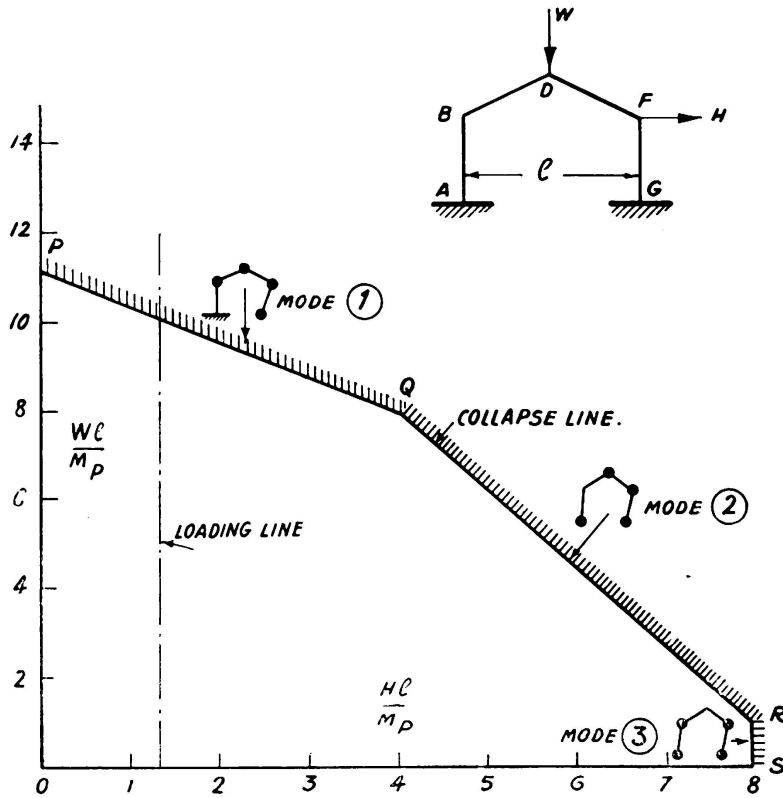

FIG. 5

The vertical deflection of the apex of portal 4 A is shown in Fig. 7, and the horizontal deflections of the tops of the stanchions in Fig. 8. The first signs of yield were observed as follows:—

Vertical Load of	9 tons.	Yield at Joint F
»	» 10.5 tons.	» » » B
»	» 11.75 tons.	» » » D
»	» 12.0 tons.	» » » G

In accordance with usual experimental practice, the creep of deflections after loading was allowed to continue until it reached the negligible value of about 0.005 inches per minute. The deflections were then recorded, and the next load increment added.

(c) Control Tests.

In order to obtain values for the elastic flexural rigidity and full plastic moment of the 7" x 4" R. S. J. from which the frame was made, bend tests were carried out on four beams, each 8 feet long, cut from the same material. They were tested as simply supported beams in an

Amsler 500 ton Compression Machine, two of them being loaded by a central concentrated load, and two by a pair of equal concentrated loads symmetrically placed on either side of the centre of the beam.

The following average values were obtained:

Full plastic moment, M_p	247 tons inches
Elastic Flexural Rigidity, EI	5.73×10^5 tons ins. ²

4. Analysis of the Test Results.

(a) Elastic Behaviour.

The moments and deflections of the portal in the elastic range were calculated theoretically by slope-deflection methods, and the corresponding elastic load deflection lines are shown in Figs. 7 and 8. It will be seen

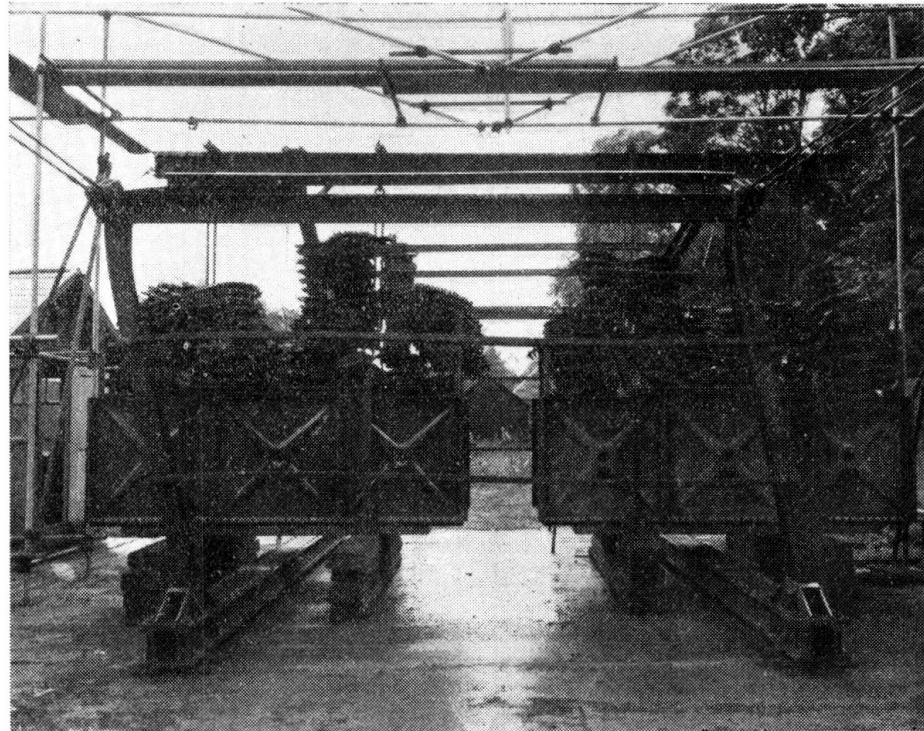

FIG. 6. End view of frame after collapse

that, in each case, the portal was less rigid than theory predicted. Full account was taken of the deflection of the girder to which the stanchion feet were attached, but the attachments themselves formed a connection of unknown rigidity. They consisted of 1" thick plates profile welded to the stanchions, bolted to the girder, and stiffened by some $\frac{1}{2}$ " thick web plates (Figs. 2 and 6) and although they appeared rigid in the engineering sense, it must be concluded that they did in fact deform sufficiently to produce deflections in excess of those calculated.

A full plastic moment of 247 tons inches corresponds to a maximum elastic moment of resistance 216 tons inches. A moment of this value

is theoretically first attained in the frame at the point D, directly under the vertical load, when $H = 1.70$ tons, and $W = 9.55$ tons.

It will be seen from Figs. 7 and 8 that the load-deflection curves for the portal 4 A depart from the elastic line at a vertical load of about 8 tons. This premature departure from elastic behaviour is due both to residual stresses in the members forming the portal and to the lack of complete rigidity in the connections. It is a measure of the extent to which an elastic analysis differs from reality when applied to a «rigidly jointed» structure.

(b) *Plastic Behaviour.*

The portal was designed on the assumption that, at collapse, plastic hinges would form at the four points B, D, F and G (Fig. 1). However, owing to local increases in the depth of the section at B and F, due to the construction of the joints, plastic hinges did not form at these points, but at L and M where the section had returned to normal.

Assuming plastic hinges transmitting a moment $M_p = 247$ tons inches at the points L, D, M and G, the load system appropriate to this set of moments is found to be

$$W = 13.36 \text{ tons. } H = 1.70 \text{ tons.}$$

The deflections of the portal at the time of formation of these plastic hinges can be calculated by an approximate method due to Neal and Simonds [9]. This method assumes that, until the formation of the fourth and last hinge, those plastic hinges which have already formed rotate at a constant moment M_p , and that the members between the plastic hinges still remain entirely elastic. At the time of formation of the final plastic hinge, this hinge has not rotated, so that continuity can be assumed over it and thus the deflected form of the portal can be determined. The method is only approximate, in that it neglects strain hardening in the plastic hinges and the spread of plastic zones along the members. These two effects tend to cancel one another.

Using this method, it is found that the hinge at G is the last to form, and the deflections of the frame at the formation of this hinge are

$$\begin{aligned} B &= -0.16 \text{ inches.} \\ F &= +1.18 \quad \gg \\ D &= +1.70 \quad \gg \end{aligned}$$

Using the deflected form of the frame, a correction can be made to the calculation of the load system appropriate to this condition. It is found to be

$$W = 13.13 \text{ tons } H = 1.70 \text{ tons.}$$

The points corresponding to these loads and deflections are shown in Figs. 7 and 8. Considering the somewhat sweeping assumptions made

in calculating the deflections, these points are in surprisingly good agreement with the experimental results.

(c) *Final Collapse.*

Three estimates of the collapse loads have been obtained theoretically, each more refined than the last.

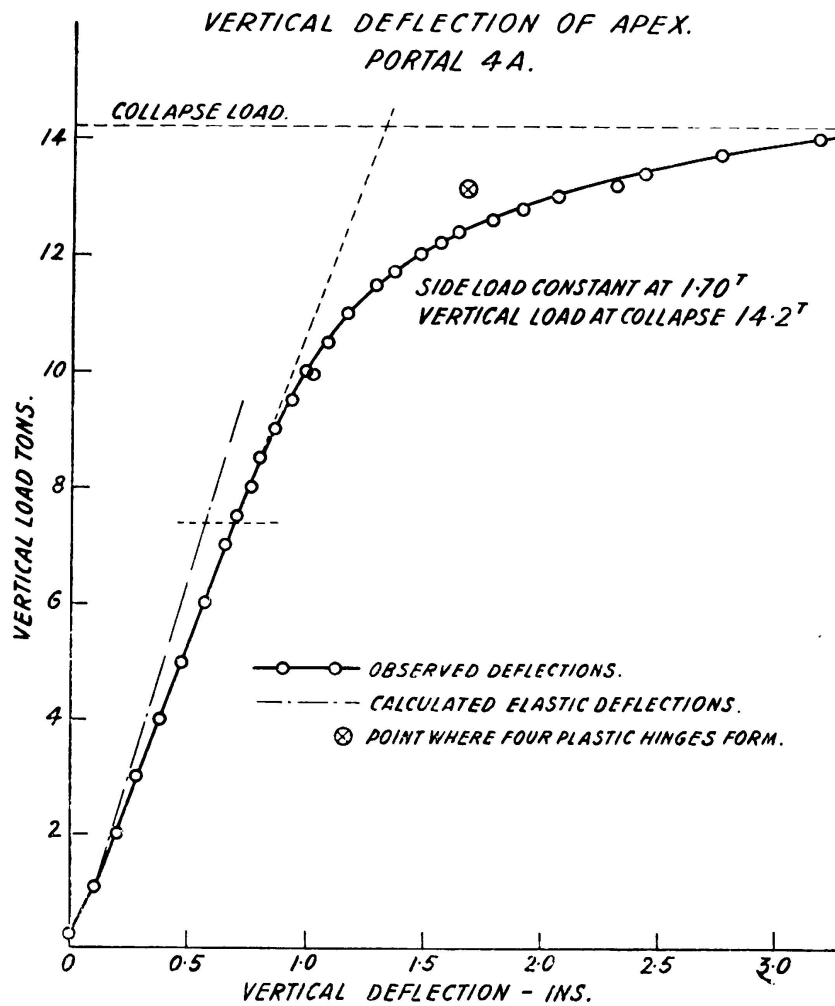

FIG. 7

- They assume (1) that the plastic hinges are at B, D, F and G (Fig. 1)
- (2) that the plastic hinges are at L, D, M and G.
- (3) that, with hinges as in (2), the portal has deformed according to the deflections calculated above.

The values of these three estimates of the collapse load are

- | | | |
|-----|------------------|------------------|
| (1) | $W = 12.95$ tons | $H = 1.70$ tons |
| (2) | $W = 13.36$ tons | $H = 1.70$ tons |
| (3) | $W = 13.13$ tons | $H = 1.70$ tons. |

The portal finally collapsed when the vertical load W was 14.2 tons, so that all three estimates are conservative. The increase in load carrying capacity above the theoretical is almost certainly due to strain hardening in the plastic hinges.

5. Conclusions.

Although the combined effects of strain hardening and lateral instability complicate the behaviour of the structure, the test on the symmetrical pitched roof portal demonstrates that the simple plastic

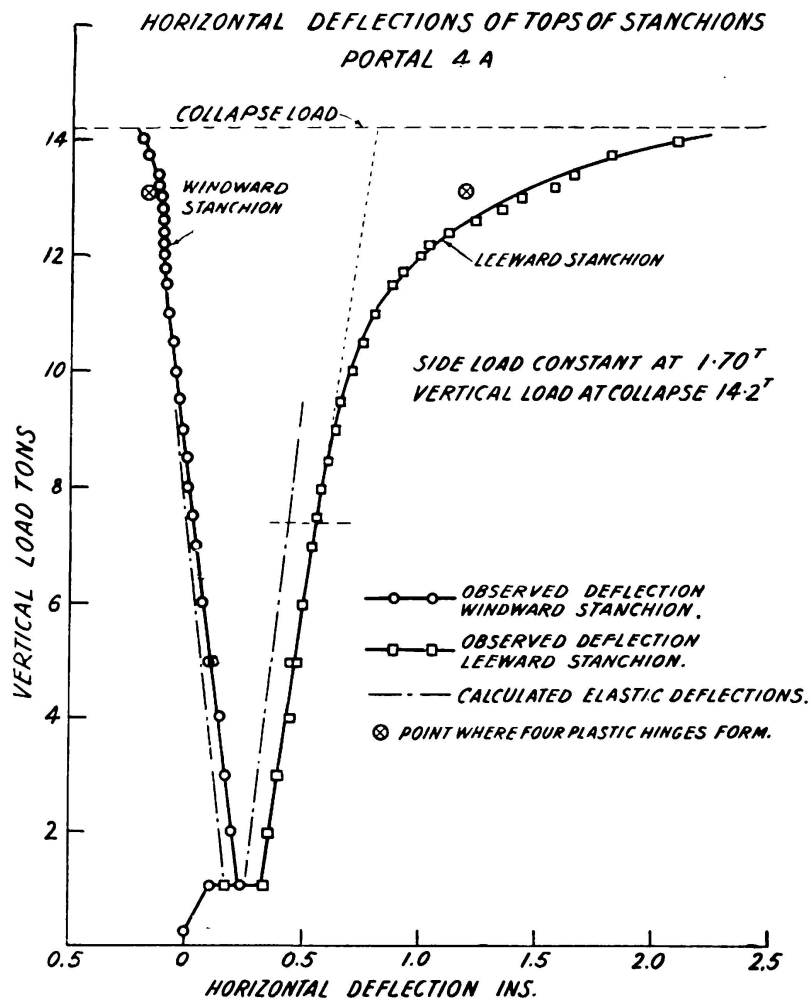

FIG. 8

theory can predict satisfactorily the mode of failure of such a structure, the load at which the deflections become large, and the approximate value of those deflections. The theory may therefore be used with confidence to form the basis of a design method.

The frame finally collapsed laterally, and the precise form of collapse was of course influenced by the amount of lateral bracing between the

portals. This consisted in the main of the eaves beams, purlins and sheeting rails, but it must not be forgotten that the connection between the apex of each frame and the main loading beam (Fig. 4) prevented the apex from twisting, and thus provided a restraint which would not have been there if the frames had been loaded by separate tanks. It is, however, common practice to provide a double purlin at the ridge of the roof of a shed building composed of such frames, so that the restraint provided was not wholly unrepresentative.

It is unlikely that the addition of further lateral bracing between the frames would have increased the collapse load, although such an addition might have affected the precise type of lateral instability which took place at final collapse, or have prevented lateral instability altogether, in which case failure would have occurred by ever increasing vertical and longitudinal deflections.

If a load factor of 1.75 is assumed, the corresponding working load would be $W = 7.4$ tons, $H = 0.97$ tons per portal.

It will be seen from Figs. 7 and 8 that under these working loads the frame would be elastic, with approximate deflections of 0.68 inches vertical at the apex and 0.51 inches horizontal at the top of the leeward stanchion.

6. Acknowledgements.

The authors wish to express their thanks to the Department of Scientific and Industrial Research, and the British Welding Research Association, whose continued support has made the experimental work possible.

REFERENCES

- (1) BAKER, J. F.—*The Steel Skeleton*. Volume 1. Elastic Behaviour and Design. Camb. Univ. Press. 1954.
- (2) BAKER, J. F.—*The Design of Steel Frames*. J. Inst. Struct. Engrs. Vol. 27 (1949-50) p. 397.
- (3) NEAL, B. G. and SYMONDS, P. S.—*The Calculation of Plastic Collapse Loads for plane frames*. I. A. B. S. E. 4th Congress 1952.
- (4) HORNE, M. R.—*Experimental investigations into the behaviour of continuous and fixed-ended beams*. I. A. B. S. E. 4th Congress 1952.
- (5) BAKER, J. F. and HEYMAN, J.—*Tests on Miniature Portal Frames*. J. Inst. Struct. Engrs. Vol. 28 (1950).
- (6) BAKER, J. F., HORNE, M. R. and HEYMAN, J.—*The Steel Skeleton*, Volume 2. Plastic Behaviour and Design. Camb. Univ. Press. 1956.
- (7) BAKER, J. F. and RODERICK, J. W.—*Tests on Full Scale Portal Frames*. Proc. Inst. Civ. Engrs. Part I Volume I (1952).
- (8) BAKER, J. F. and EICKHOFF, K. G.—*The Behaviour of Saw Tooth Portal Frames*. Inst. Civ. Engrs. Conference on the Correlation of Stresses and Displacements 1955.
- (9) SYMONDS, P. S. and NEAL, B. G.—*The Interpretation of Failure Loads in the Plastic Theory of Continuous Beams and Frames*. J. Aer. Sci. Vol. 19 (1952).

SUMMARY

A number of full size rectangular portal frames have been tested to collapse under various combinations of side and vertical load. The experimental results have been in good agreement with the predictions of the simple plastic theory. While the rectangular frame has many practical uses, the portal with pitched roof is more common in building structures, and due to the thrust in the rafters and the differential sway of the stanchions, its analysis is more complicated.

This paper describes the behaviour of a symmetrical pitched roof portal having a span of 16 feet, a stanchion height of 8 feet, and a roof slope of $22\frac{1}{2}^\circ$, constructed throughout of $7'' \times 4'' \times 16$ lb. per foot R. S. J. (British Standard No. 111), the joints being made by cutting the ends of the joists to the required angles and profile welding them to $\frac{3}{8}$ inch thick division plates. The portal was subjected to a concentrated horizontal load of 1.70 tons applied at the top of one stanchion, and a concentrated vertical load at the apex of the rafters, the vertical load being increased until collapse occurred. The deflections of the portal during loading and at collapse were recorded.

The observed behaviour of the frame is analysed according to the elastic and simple plastic theories, and the observed collapse load and mode are shown to be in good agreement with those predicted.

ZUSAMMENFASSUNG

Eine Anzahl rechteckiger Rahmen wurden bei verschiedenen Zusammensetzungen von seitlichen und vertikalen Belastungen, die bis zum Bruch führten, untersucht. Die gewonnenen Ergebnisse stimmten gut mit den vorausgerechneten Werten der einfachen Plastizitätstheorie überein. Während der Rechteckrahmen ganz verschiedenartige praktische Aufgaben erfüllen kann, ist der Portalrahmen mit geneigten Dachflächen vorwiegend im Hochbau üblich; mit Rücksicht auf die Schubkräfte in den Sparren und die verschiedenartige Beeinflussung der Stiele bietet die Berechnung mehr Schwierigkeiten als beim Rechteckrahmen.

In diesem Bericht wird das Verhalten eines symmetrischen Dachrahmens behandelt, dessen Spannweite 16 Fuss und dessen Stielhöhe 8 Fuss beträgt; das Dach hat eine Neigung von $22\frac{1}{2}\%$. Stiele und Sparren sind Doppel-T-Profile vom Brit. Standard-Typ Nr. 111. Die Profilenden waren auf die entsprechenden Winkel zugeschnitten und an den Stoss-Stellen über $\frac{3}{8}$ Zoll dicke Platten miteinander verschweisst.

Am obern Stielende wurde eine horizontale Einzellast von 1,70 Tonnen und am Giebelpunkt eine vertikale Einzellast angebracht. Die Grösse der letzteren wurde bis zur Bruchlast gesteigert und die Formänderungen während der Belastung und beim Bruch aufgezeichnet. Es ergab sich eine gute Uebereinstimmung zwischen den Versuchsergebnissen und auf Grund der Elastizitäts- und Plastizitätstheorie ermittelten Werten.

RESUMO

Efectuaram-se ensaios de rotura com vários modelos de pórticos em escala natural, submetendo-os a diversas combinações de cargas laterais e verticais; os resultados experimentais coincidem com os obtidos pela aplicação da teoria plástica simples. Se bem que o quadro rectangular tenha numerosas aplicações práticas, o pórtico de duas águas é de uso mais corrente nas estruturas de edifícios; a existência de esforços normais nas vigas e a deformação diferencial dos montantes tornam no entanto o cálculo mais difícil que no caso dos quadros rectangulares.

O autor descreve o comportamento de um pórtico simétrico de duas águas com 16 pés de vão, montantes de 8 pés de altura e uma inclinação de vertentes de $22\frac{1}{2}^{\circ}$. Este pórtico foi inteiramente construído em perfilados I de $7'' \times 14''$ pesando 16 lbs/pé (British Standard N.º 111). As juntas obtiveram-se cortando a extremidade dos perfilados com a inclinação desejada, soldando-os a seguir a chapas de ligação de $\frac{3}{8}''$ de espessura.

O pórtico foi submetido a uma carga horizontal concentrada de 1,70 toneladas, aplicada no topo de um pilar e a uma carga vertical concentrada aplicada no vértice das duas vigas, tendo-se aumentado gradualmente esta última até à rotura. Mediram-se as deformações do pórtico durante a carga e quando da rotura.

O comportamento do pórtico durante o ensaio foi estudado pela teoria da elasticidade e pela teoria plástica simples, estando os valores observados para a carga e o modo de rotura perfeitamente de acordo com os valores previstos pelo cálculo.

RÉSUMÉ

Des essais à la rupture ont été effectués sur un certain nombre de modèles de portiques en vraie grandeur, soumis à différentes combinaisons de charges latérales et verticales; les résultats expérimentaux coïncident avec ceux obtenus par l'application de la théorie plastique simple. Bien que le cadre rectangulaire trouve de nombreuses applications pratiques, le portique à deux pans se rencontre plus couramment dans les structures de bâtiments; la présence d'efforts normaux dans les poutres, ainsi que la déformation différentielle des piliers rendent néanmoins leur calcul plus difficile que celui des cadres rectangulaires.

Ce mémoire décrit le comportement d'un portique symétrique à deux pans ayant une portée de 16 pieds, une hauteur de piliers de 8 pieds l'inclinaison des pans étant de $22\frac{1}{2}^{\circ}$. Ce portique a été entièrement construit en profilés I de $7'' \times 14''$ pesant 16 lbs/pied (British Standard N.º 111), les joints étant obtenus en coupant les extrémités des profils avec l'inclinaison voulue et en les soudant ensuite à des plaques de liaison de $\frac{3}{8}''$ d'épaisseur.

Le portique a été soumis à une charge horizontale concentrée de 1,70 tonnes appliquée au sommet d'un pilier et à une charge verticale concentrée appliquée au sommet des poutres; cette dernière ayant été graduellement

augmentée jusqu'à la rupture. Les déformations du portique ont été mesurées pendant la mise en charge et lors de la rupture.

Le comportement du portique pendant l'essai a été étudié en appliquant la théorie de l'élasticité et la théorie plastique simple, et les valeurs observées pour la charge et le mode de rupture sont en parfait accord avec les valeurs prévues par le calcul.

Leere Seite
Blank page
Page vide