

Comparative tests on concrete beams and slabs reinforced with mild steel and deformed bar

Autor(en): **Lewis, H.E.**

Objektyp: **Article**

Zeitschrift: **IABSE congress report = Rapport du congrès AIPC = IVBH
Kongressbericht**

Band (Jahr): **5 (1956)**

PDF erstellt am: **22.07.2024**

Persistenter Link: <https://doi.org/10.5169/seals-6011>

Nutzungsbedingungen

Die ETH-Bibliothek ist Anbieterin der digitalisierten Zeitschriften. Sie besitzt keine Urheberrechte an den Inhalten der Zeitschriften. Die Rechte liegen in der Regel bei den Herausgebern.

Die auf der Plattform e-periodica veröffentlichten Dokumente stehen für nicht-kommerzielle Zwecke in Lehre und Forschung sowie für die private Nutzung frei zur Verfügung. Einzelne Dateien oder Ausdrucke aus diesem Angebot können zusammen mit diesen Nutzungsbedingungen und den korrekten Herkunftsbezeichnungen weitergegeben werden.

Das Veröffentlichen von Bildern in Print- und Online-Publikationen ist nur mit vorheriger Genehmigung der Rechteinhaber erlaubt. Die systematische Speicherung von Teilen des elektronischen Angebots auf anderen Servern bedarf ebenfalls des schriftlichen Einverständnisses der Rechteinhaber.

Haftungsausschluss

Alle Angaben erfolgen ohne Gewähr für Vollständigkeit oder Richtigkeit. Es wird keine Haftung übernommen für Schäden durch die Verwendung von Informationen aus diesem Online-Angebot oder durch das Fehlen von Informationen. Dies gilt auch für Inhalte Dritter, die über dieses Angebot zugänglich sind.

V a 5

**Comparitive tests on concrete beams and slabs reinforced
with mild steel and deformed bar**

**Vergleichende Untersuchungen an Betonbalken und -Platten,
welche mit Weichstahl und gedrehten Einlagen
bewehrt sind**

**Ensaio comparativos de vigas e lajes de betão
armadas com aço macio e varões estriados**

**Essais comparatifs de poutres et de dalles en béton, armées
de ronds en acier doux et de ronds striés**

H. E. LEWIS

Cement and Concrete Association
London

1. Introduction

Tensile reinforcement in concrete members has hitherto in the United Kingdom been generally confined to plain round mild steel bars and cold twisted steel bars of circular and square section. With the advent of home produced Tentor deformed bar it was considered necessary to carry out some tests, albeit of restricted scope, to compare the behaviour of members reinforced with the new steel with others which were conventionally reinforced with plain mild steel bars.

Tentor is an improved type of deformed bar which was first produced in Denmark. It is produced from hot rolled mild steel round bars manufactured to British Standard 785 having two parallel diametrically opposed longitudinal ribs and transverse ribs whose inclination to the longitudinal axis is such that after cold working their directions are reversed on opposite sides of a longitudinal rib, Figure 1.

The cold working is a combination of tension and twisting which respectively give an overall increase to the strength of the bar and an increase mainly localised in the outer fibres.

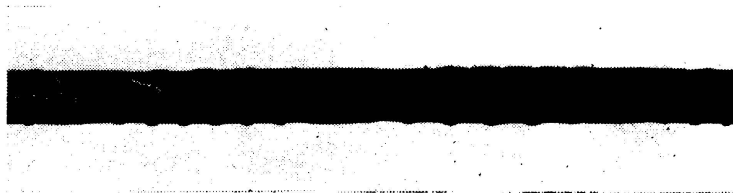

FIG. 1. The $\frac{3}{4}$ in. diameter Tentor bar

The bars are produced by an automatic process, the as-rolled bar being fed from coils and continuity maintained by butt welding the junction with a new coil, the welds themselves being adequately tested by the subsequent cold working process.

The surface characteristics of the bar comply with the specification of the American Society for Testing Materials, A 305-50 T.

The properties of the two sizes of Tentor used in the work to be described were determined by tests and are given in Table 1, together with the corresponding details for the round mild steel bars used. It should be noted, diameter refers to equivalent diameter, i. e. the diameter of a plain bar having the same weight per unit length.

Since Tentor has no definite yield a conventional yield stress is taken to be that stress which produces a strain of 0.5 per cent. This is the figure specified in B. S. 1144. Cold Twisted Steel Bars for Concrete Reinforcement.

Suggestions for the use of this type of bar have been made by a committee of the Institution of Structural Engineers, but recommendations as to its properties have not, as yet, been included in any specification of the British Standards Institution.

The suggestion with regard to permissible working tensile stress is that it should not exceed one-half of the yield stress or 33,000 lb/sq. in. whichever is the smaller. In slabs, however, the limit may be increased to 37,000 lb/sq. in.

Design suggestions are that deformed bar can be substituted for mild steel in the inverse ratio of working stresses without modification to the concrete section, provided that deflection does not become excessive.

2. *Scope of tests*

Tests were carried out primarily to investigate the behaviour of typical beams and slabs insofar as cracking, deflection and factor of safety against flexural failure were concerned. Tests were also carried out on short beams to study the relative bond resistance of the two steels with concrete.

3. *Beam tests*

The system adopted in casting beams was to manufacture in each operation a pair of long beams and a pair of short beams, one of each pair having mild steel reinforcement and the other Tentor.

Table 2 gives the 28 day cube strength for each casting operation. Specimens are given the following code letters:—

- A Long beams with Tentor reinforcement
- B Long beams with mild steel reinforcement
- C Short beams with Tentor reinforcement
- D Short beams with mild steel reinforcement

A particular member is designated by its casting number after its code letter e. g. A3 (h), where in addition (h) signifies that the main bars were hooked. The concrete strength varied considerably from operation

TABLE 1
Properties of steels

Properties	Tentor		Mild Steel	
	$\frac{3}{4}$ in. diam.	$\frac{3}{8}$ in. diam.	1 in. diam.	$\frac{1}{2}$ in. diam.
Equivalent diameter (in.)	0.765	0.391		
Measured diameter (in.)			1.004	0.497
Cross-sectional area (sq. in.)	0.460	0.120	0.792	0.194
Ultimate stress (lb/sq. in.)	81,900	83,400	62,700	65,000
Yield stress (lb/sq. in.)	71,000*	71,400*	39,600	39,300
Young's modulus (lb/sq. in.)	28.9×10^6	30.2×10^6	30×10^6	30.4×10^6
Elongation at failure (per cent)	5**	9**	24**	25**

* Conventional yield stress: Stress at a strain of 0.5 per cent.

** Excluding «necking» zone.

TABLE 2
Details of concrete crushing strengths for beams

Casting operation	Specimens cast	Concrete crushing strength (28 days) (lb/sq. in.)
1	A 1 (h), B 1 (h) C 1, D 1	2,570
2	A 2, B 2* C 2 (h), D 2 (h)	
3	A 3 (h), B 3 (h) C 3 (h), D 3 (h)	4,310
4	A 4, B 4 C 4, D 4	5,300
5	A 5, B 5	4,350

* Broke in handling.

to operation due to the fact that the concrete was produced under site conditions. The strength from the first casting was extremely low and was probably the result of the concrete being affected by the very cold weather at that time.

It was intended that the concrete should correspond to the 1 : 2 : 4 by volume Portland Cement concrete which is the leanest mix specified in

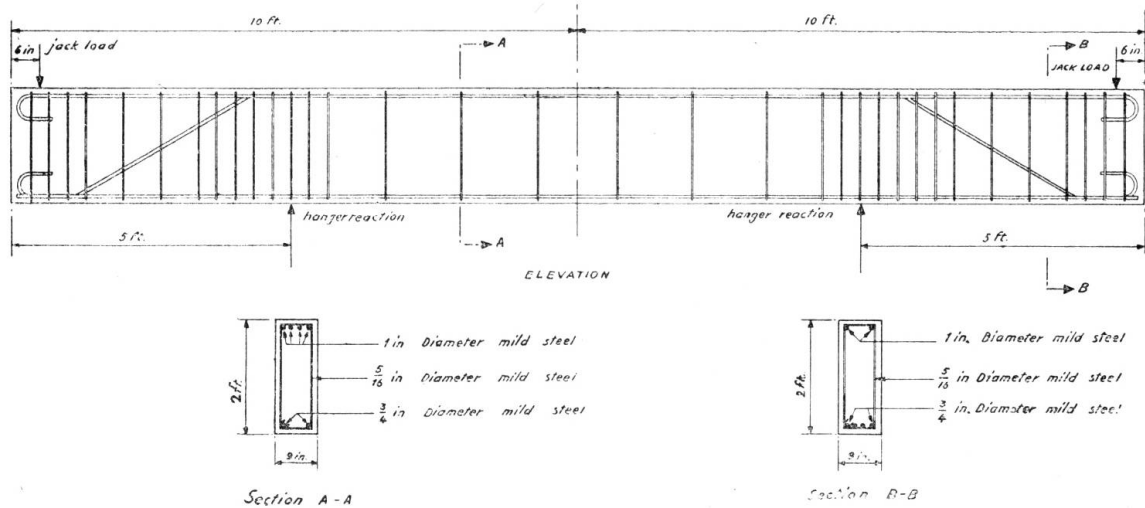

FIG. 2. Dimensions and reinforcement of 20 ft beam with mild steel

the British Standard Code of Practice CP 114 (1948) The Structural Use of Normal Reinforced Concrete in Buildings. The mix proportion used was 1 : 6.5 by weight with a nominal water-cement ratio of 0.65 since the concrete was to be hand placed.

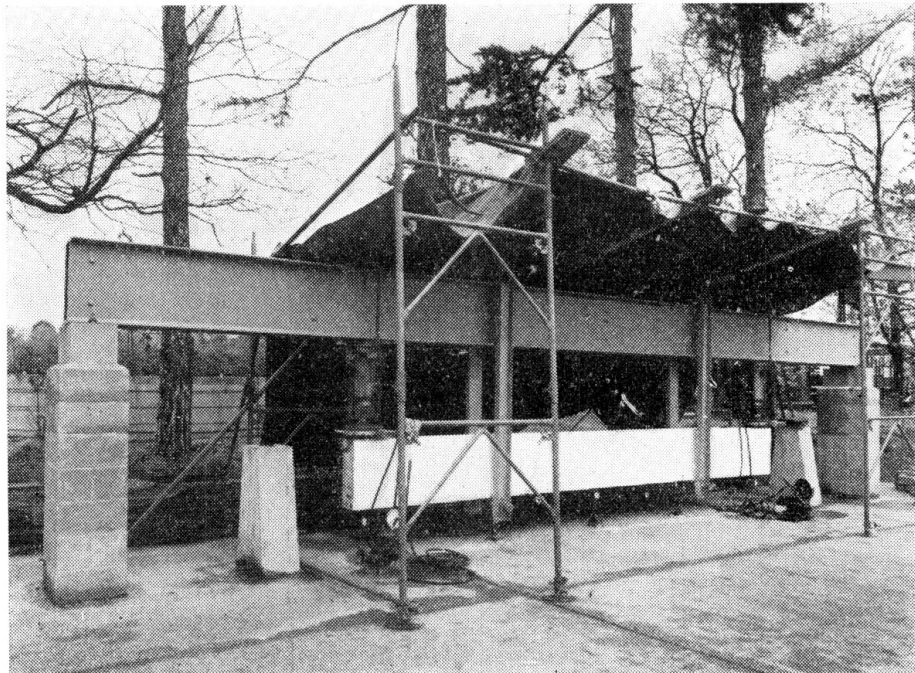

FIG. 3. Method of test of 20 ft beams

The long beams were of 20 ft overall length and had a rectangular section of 24 in. \times 9 in. The standard beam, Figure 2 was the one with mild steel reinforcement which comprised four 1 in. diameter bars lying in a horizontal plane with a cover of 1 in.

The beams were tested in an inverted position by application of point loads from hydraulic jacks 6 in. in from each end, and they were suspended at points 5 ft on either side of the centre section, Figure 3. Outside the zone of uniform bending moment adequate shear resistance was supplied by stirrups and the bending up of some of the tensile bars.

The applied load necessary to create the working steel stress of 18,000 lb/sq. in. was 8.55 tons on each jack. The corresponding concrete stress was 1,140 lb/sq. in. The usual reinforced concrete design theory was used in these calculations using a modulus of elasticity ratio of 15.

The size of bar in the Tentor reinforced beams was determined by a bar by bar substitution in the inverse ratio of the working stresses, 18,000 lb/sq. in. and 33,000 lb/sq. in. Thus the requisite area of one bar was 0.43 sq. in. The nearest convenient size was the $\frac{3}{4}$ in. diameter (equivalent) bar whose area is 0.46 sq. in. There was therefore a 7 per cent excess of steel area which, together with the higher neutral axis due to a smaller steel area, resulted in a working load on each jack of 9.56 tons. The maximum theoretical compressive stress in the concrete under this load was 1,480 lb/sq. in.

Testing was carried out by simultaneous application of equal load increments to the two hydraulic jacks. At convenient intervals in the loading the number of cracks occurring on the top surface of the beams within the middle 8 ft 8 in. were recorded together with the maximum crack width existing at steel level and the deflection at mid-span relative to the ends. Periodically surface strain measurements were taken down the depth of the beam at mid-span.

Table 3 gives details of the number and spacing of cracks in the various beams at their working load and also at a 50 per cent overload. There are random variations between the groups of beams but there is no indication of any trend related to concrete strength, neither is there any noticeable difference between beams having hooked bars and those having straight bars, Therefore the results for all the beams have been averaged to give figures which indicate a slightly closer spacing of cracks in Tentor reinforced beams.

Steel stresses were calculated at various load stages by the standard method with 'm' equal to 15. Figure 4 indicates the upper and lower limits of maximum crack widths measured at any particular steel stress for both types of specimen. The stresses as shown are a little higher than those which actually existed since strain readings on the concrete indicated a neutral axis position slightly nearer the compression face than the calculated position; however, both types of beam are similarly affected.

In Table 4 the average values of maximum crack widths measured in similar beams are tabulated for proportions of the steel working stresses and it is seen that in the region of working stress the maximum crack width in Tentor reinforced beams is 2 to 2 $\frac{1}{2}$ times greater than in mild steel reinforced beams but the crack widths at working stresses

TABLE 3

Number of tensile cracks falling within a length of 8ft 8in. in the zone of uniform bending moment in 20 ft beams

Reference mark	Average cube strength (lb/sq. in.)	Age at tests (days)	No. of cracks at working load	No. of cracks at 50 per cent overload
* A1 (hooked)	2,570	58	33	36
B1 (hooked)		57	34	37
A2	3,790	30	35	36
A3 (hooked)		30	37	38
B3 (hooked)	4,310	28	29	32
A4		30	31	32
B4	5,300	28	33	35
A5		35	35	38
B5	4,350	36	31	35
Average for A's			34	36
Average for B's			32	35
			Working load (in.)	50 per cent overload (in.)
Average spacing in A's			3.1	2.9
Average spacing in B's			3.3	3.0

TABLE 4

Average value of measured maximum crack widths in 20 ft beams at various proportions of the steel working stress

Steel stress as proportion of working stress	Average maximum crack width	
	Tentor (in. $\times 10^{-3}$)	Mild steel (in. $\times 10^{-3}$)
0.25	—	—
0.50	1.0	—
0.75	3.0	1.0
working stress	4.0	1.5
1.25	5.0	2.0
1.50	7.0	3.0
1.75	9.0	4.0
2.00	11.0	5.0
2.25	15.0	—

* Beam A1 was tested twice, on the first occasion loading had be discontinued at 15 tons, on the second occasion the full strength was developed. Information regarding the number of cracks was obtained from the second test. Crack width measurements are taken from the first test.

are well below the critical width of crack according to the most conservative estimate (8×10^{-3} in.). The maximum width measured at the working load for a Tentor reinforced beam was 5×10^{-3} in. and in no case was a width of 8×10^{-3} in. reached before achieving a stress of 48,000 lb/sq. in.

It should be mentioned here that no special treatment was given to the surface of the mild steel bars other than wire brushing. The bars

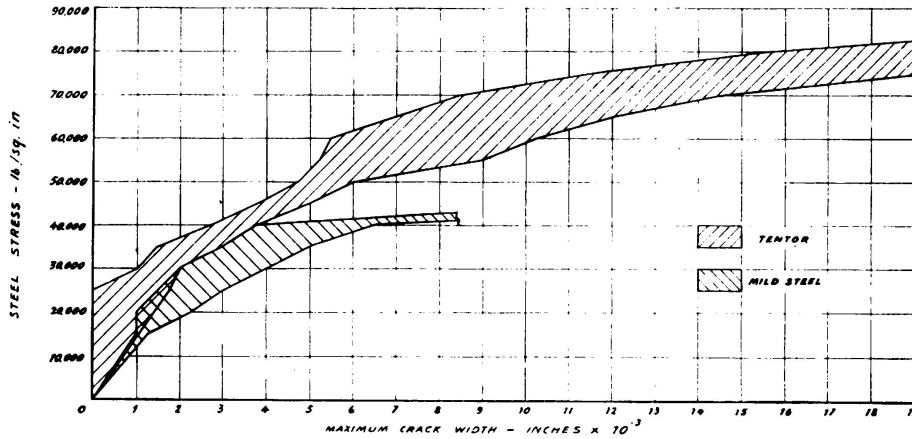

FIG. 4. Limits of maximum crack width in Tentor and mild steel reinforced beams

used in beam B1 were only slightly rusty while those used in B5 were in the average condition of bars on site.

Table 5 gives the deflection-span relationship for all the beams for which complete information was available. At both working loads and

TABLE 5

Deflection-span ratios at working load and at a 50 per cent overload in 20 ft beams

Mild Steel			Tentor steel		
Beam	Working load	50 per cent overload	Beam	Working load	50 per cent overload
B5	$\frac{1}{1,170}$	$\frac{1}{700}$	A5	$\frac{1}{640}$	$\frac{1}{400}$
B4	$\frac{1}{1,140}$	$\frac{1}{680}$	A4	$\frac{1}{620}$	$\frac{1}{380}$
B3	$\frac{1}{1,170}$	$\frac{1}{690}$	A3	$\frac{1}{620}$	$\frac{1}{380}$
			A1	$\frac{1}{510}$	$\frac{1}{320}$

50 per cent overloads, deflections are approximately 1.8 times greater in Tentor reinforced beams. It will be noticed that beam A1 which had the lowest 28 day concrete strength deflected by an amount which was significantly greater than measured values for the other Tentor reinforced beams. The load-deflection curve for beams A5 and B5 is shown in Figure 5, which emphasizes the marked difference in behaviour of the two types of beams at loads nearing failure. In contrast to the mild steel reinforced beam the Tentor reinforced beams continued to carry increasing load even at very large deflections. This was typical of all the beams of

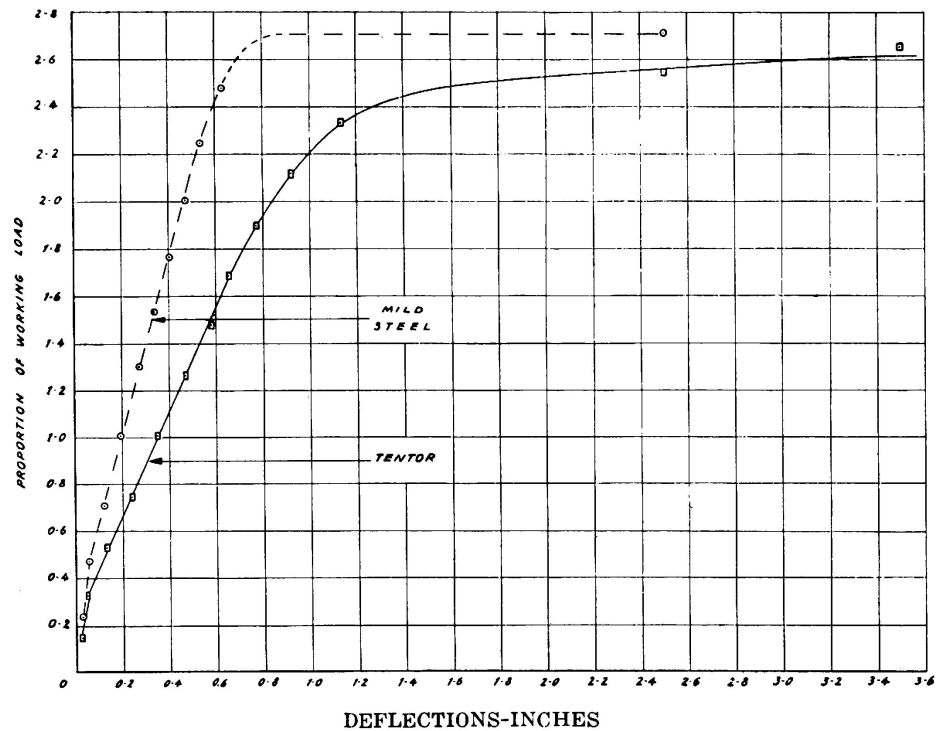

FIG. 5. Load-deflection curves. Beams A 5 and B 5

TABLE 6

Factors of safety against bending failure in 20 ft beams

Mild steel reinforced			Tentor reinforced		
Beam	Failing * load (tons)	F. S. **	Beam	Failing * load (tons)	F. S. **
B 1	22.35	2.57	A 1	22.90	2.37
B 3	22.00	2.52	A 3	24.30	2.46
B 4	21.00	2.41	A 4	24.00	2.46
B 5	23.00	2.64	A 5	25.00	2.57

NOTE: * Failing load is the applied load on *each* jack which causes either crushing of the concrete or increasing deflection under almost constant load.

** Ratio of failing load plus dead load bending moment to working load plus dead load bending moment.

this type which sustained such large deflections that it was possible to produce failure in beam A1 only. The other beams were loaded to practically their failing load but deflections were so great as to make it necessary to terminate the tests.

Table 6 gives the factors of safety against flexural failure as the ratios of total bending moment at failure to total bending moment under the working load. For the Tentor reinforced beams the figures are calculated for the maximum applied load which in all cases except A1 was less than the failing load. The reserve of strength which these beams had could not however have been sufficiently large to alter materially the figures given.

In the tests on the long beams the loading conditions were not of the appropriate form to test the efficiency of un-hooked Tentor bar, in fact there was no difference between the behaviour of beams with straight

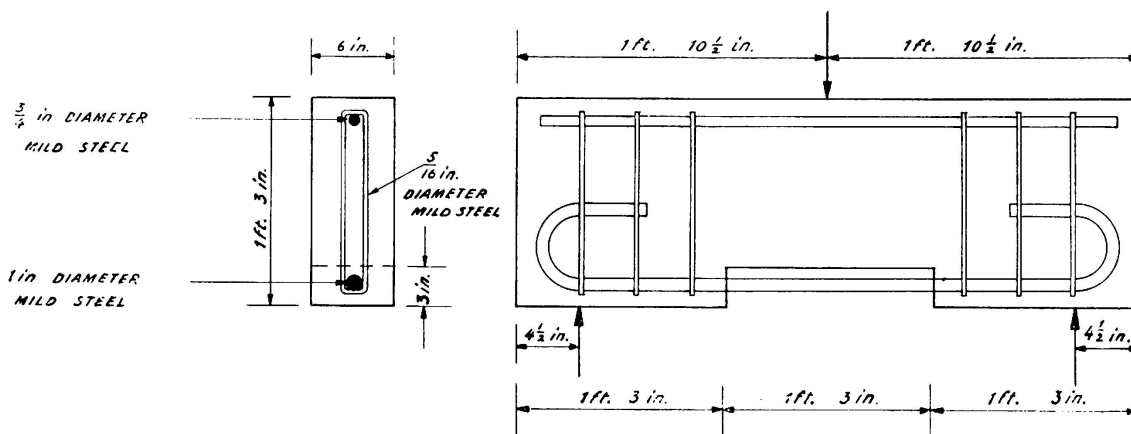

FIG. 6. Dimensions and reinforcement of short beam with mild steel

and hooked mild steel bars. The tests on short beams were made specially to obtain some indication of the bond with concrete of the two types of steel.

The test specimens were of an overall length of 3 ft 9 in. and had rectangular sections of 15 in. \times 6 in. and were reinforced with either one 1 in. diameter mild steel bar or one $\frac{3}{4}$ in. diameter Tentor bar, both having a cover of 1 in. Over a central length of 15 in. the depth of the beams was reduced by 3 in. to enable strain measurements to be taken on the steel. Figure 6 shows the details of reinforcement for a member with hooked mild steel bar. Loading was by a central point load, the beam being supported on a span of 3 ft., Figure 7. During the progress of the tests strain readings were taken on the reinforcement by means of a demountable mechanical strain gauge having an 8 in. gauge length. The operation of the gauge necessitated the drilling of a pair of very small shallow holes in the steel on each of two diametrically opposite generators.

In some of the beams the bars were hooked while in others they were straight, also some beams were without any secondary reinforcement while others had three stirrups of $\frac{5}{16}$ in. diameter in each end. In all cases the tensile bars were embedded $13\frac{1}{2}$ in. in the concrete at each end.

Table 7 gives the average bond stress in each beam at its ultimate load together with remarks on the mode of failure.

Since no legitimate assumption could be made concerning the distribution of bond stress along the bars an average figure has been tabulated, being the load in the bar divided by the embedded surface area. In the case of Tentor steel the perimeter of the bar has been taken to be that of the equivalent diameter bar. Where bars were hooked the length of hook has not been included in the embedded length used for calculation.

Table 7 shows that in the case of hooked bars and no stirrups the beams failed by the splitting away of the sides due to the movement of the hook, this occurred at very nearly the same bar load for Tentor as for mild steel. Where there were no hooks the mild steel bar pulled out freely at an average bond stress of 340 lb/sq. in. while the Tentor bar

again, due to lateral pressure from the deformations, caused splitting of the sides of the beam. The average bond stress was 550 lb/sq. in.

The addition of even a moderate quantity of stirrups proved most beneficial to the behaviour of the Tentor bar. The tensile stress in the straight bar was increased by more than 80 per cent and the average bond stress was 1,000 lb/sq. in. while the increase for the straight mild steel bar was less than 20 per cent, the average bond stress being 400 lb/sq. in.

When hooks and stirrups were used there was for mild steel an increased of about 11 per cent over the tensile stress in a hooked bar without stirrups. The average bond stress on the depth of embedment only was 660 lb/sq. in. The corresponding increase for Tentor bar was 38 per cent; the bond stress being 1,080 lb/sq. in.

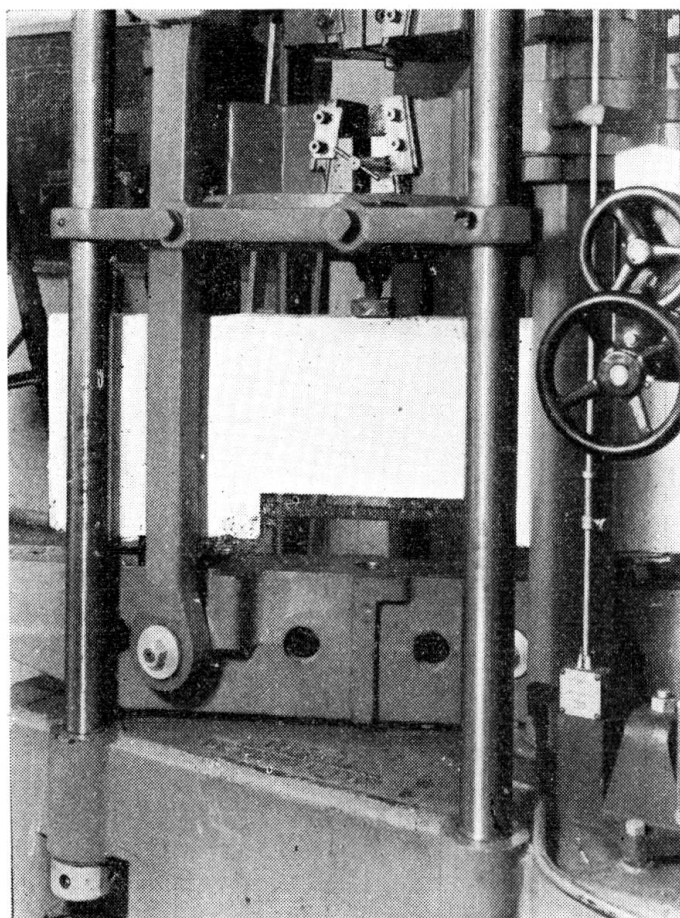

FIG. 7. Method of test of short beams

Although these tests were not sufficient in number to detect the influence of random variation to which bond tests are notoriously prone a striking feature is the excellent behaviour of straight Tentor bar when stirrups are used. The tensile stress which the bar developed was more than twice as high as that developed by mild steel hooked bar.

TABLE 7

Values of average bond stress in short beams at ultimate loads

Specimen	Steel	Age (days)	Cube strength (lb/sq. in.)	Hooks	Stirrups	Load (tons)	Bar Force (tons)	Bar stress (lb/sq. in.)	Average Bond Stress (lb/sq. in. *)
C1	Tentor	28	2,570	No	No	13.0	7.9	38,700	550
D1	M. S.	31				10.0	6.4	18,200	340
C2	Tentor	27	3,790	Yes	No	18.6	11.3	55,500	790
D2	M. S.	27				18.9	11.2	31,800	590
C3	Tentor	35	4,310	Yes	Yes	26.6	15.6	76,000	1,080
D3	M. S.	35				22.2	12.5	35,500	660
C4	Tentor	36	5,300	No	Yes	25.1	14.5	70,600	1,000
D4	M. S.	36				13.7	8.4	23,910	400

Specimen	Remarks
C1	Radial cracking around emerging bar at between 6 and 7 tons. These cracks intersected the faces of the beam and increased in size with increasing load.
D1	Bar pulled out freely without cracking of concrete.
C2	Sudden failure. Cracks appeared in the vicinity of one hook just before ultimate load and a portion of the side of the beam was forced off.
D2	Sudden failure. Cracks appeared in the vicinity of one hook just before ultimate load and a portion of the side of the beam was forced off.
C3	Radial cracking at about 7 tons. Inclined crack formed between load point and one support at failing load. Only slight movement of the bar.
D3	Radial cracking at about 10 tons. Vertical crack occurred in end face of beam at ultimate load.
C4	Radial cracking at 9 tons. Diagonal crack between load and one support at failing load. Pull out quite pronounced before crack formed.
D4	Radial cracking at 10 tons. No other damage to concrete.

NOTE: * Average bond stresses for beams having hooked bars have been calculated for a depth of embedment of $13\frac{1}{2}$ in.

4. *Slab tests*

The same procedure was employed as with the beam tests, in that from each casting operation two slabs were made which differed only in the type of steel used. The overall length of slab was 11 ft, the width 3 ft and the depth 5 in. Reinforcement consisted of six or eleven bars of $\frac{1}{2}$ in. diameter mild steel or $\frac{3}{8}$ in. diameter Tentor with a cover of $\frac{3}{4}$ in. Eight slabs were produced from four castings and were given the following reference marks:—

Slab having eleven mild steel bars	With hooks	M. 11 (h)
	Without hooks	M. 11
Slab having six mild steel bars	With hooks	M. 6 (h)
	Without hooks	M. 6
Slab having eleven Tentor bars	With hooks	T. 11 (h)
	Without hooks	T. 11
Slab having six Tentor bars	With hooks	T. 6 (h)
	Without hooks	T. 6

The concrete mixes were, as before, equivalent to 1 : 6 by volume. The crushing strengths of the concrete in the various slabs are given in Table 8.

Testing was carried out on a span of 10 ft by equal loads at the third points, the loads being distributed laterally through 6 in. \times 6 in. broad flanged beams, Figures 8 and 9.

TABLE 8

Concrete strength and age data for 11 ft slabs

Reference mark	Age at test (days)	Age of 6 in cube at test (days)	Average cube strength (lb/sq. in.)
M. 11 (h)	66	23	4,210
T. 11 (h)	72		
M. 11	35	35	3,950
T. 11	36		
M. 6 (h)	34	35	4,270
T. 6 (h)	35		
M. 6	35	35	5,140
T. 6	34		

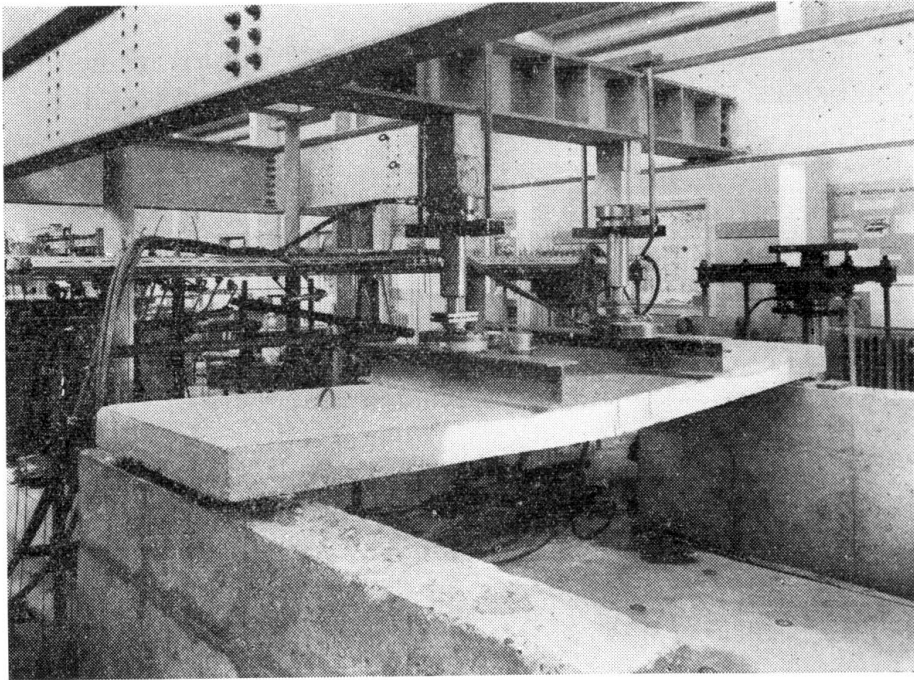

FIG. 8. Condition at maximum load of a slab with six mild steel bars

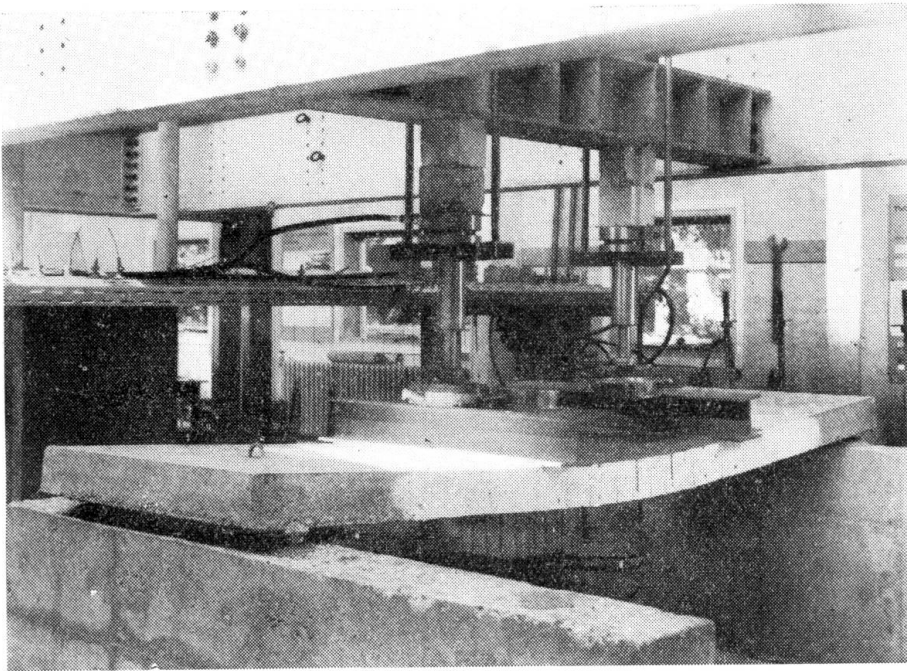

FIG. 9. Condition at maximum load of a slab with six Tentor bars

The loads on each jack calculated to produce the working stresses of 18,000 lb/sq. in. and 33,000 lb/sq. in. in the steels were as follows:—

Slabs with eleven bars:—

Mild steel reinforced: 2,430 lb
(concrete stress: 1,120 lb/sq. in.)

Tentor reinforced: 3,030 lb
(concrete stress: 1,480 lb/sq. in.)

Slabs with six bars:—

Mild steel reinforced: 1,055 lb
(concrete stress: 760 lb/sq. in.)

Tentor reinforced: 1,368 lb
(concrete stress: 1,020 lb/sq. in.)

TABLE 9

Number of tensile cracks falling within the 40 in. zone of uniform bending moment in 11 ft slabs

Reference mark	Age at test (days)	Average cube strength (lb/sq. in.)	No. of cracks at working load	No. of cracks at 50 per cent overload
M. 11 (h)	66	4,210	8	9
T. 11 (h)	72		8	13
M. 11	35	3,450	6	11
T. 11	36		8	10
M. 6 (h)	34	4,270	0	9
T. 6 (h)	35		2	8
M. 6	35	5,140	0	7
T. 6	34		1	9
Average for M. 11 (h) and M. 11			7	10
Average for T. 11 (h) and T. 11			8	12
Average for M. 6 (h) and M. 6			0	8
Average for T. 6 (h) and T. 6			2	9
			At working load (in.)	At 50 per cent overload (in.)
Average spacing in M. 11 (h) and M. 11			5.7	4.0
Average spacing in T. 11 (h) and T. 11			5.0	3.3
Average spacing in M. 6 (h) and M. 6			—	5.0
Average spacing in T. 6 (h) and T. 6			—	4.4

The working loads are once again higher in the Tentor reinforced specimens due to the steel area being 13 per cent in excess of the figure for direct substitution in the inverse ratio of steel stresses.

During testing the loads on both jacks were increased together and details of cracking within the 40 in. zone of uniform live load bending

moment, together with deflection and surface strain measurements were recorded.

Table 9 gives particulars for each slab of the number of cracks and their spacing at the working load and 50 per cent overload. On account of the low bond stresses between the steels and concrete the effect of hooks is not reflected in the behaviour of the slabs. The variation of concrete strength also does not appear to affect the results.

The slabs with six bars had a low percentage of reinforcement considering the concrete strength and thus cracking did not occur until loads in the region of the calculated working loads were applied.

As in the beam tests the average crack spacing is closest in the Tentor reinforced slab, being closer for the larger number of bars. However in spite of the bars being of a smaller diameter than those used in the beams they did not control the spacing between cracks so well as did the 1 in. diameter and $\frac{3}{4}$ in. diameter bars.

Table 10 gives the average maximum crack widths for certain proportions of the steel working stresses. The widths for mild steel correspond with those obtained in the beams, but for the Tentor bar the widths are much smaller than they were previously for stresses near the working stress. Stresses were calculated using a constant value of 7.5 for the modulus of elasticity ratio since the concrete surface strains indicated this

TABLE 10

*Average value of measured maximum crack width
in 11 ft slabs at various proportions of the steel
working stress*

Steel stress as proportion of working stress	Average maximum crack width	
	Tentor (in. $\times 10^{-3}$)	Mild steel (in. $\times 10^{-3}$)
0.75	1.5*	1.0*
working stress	2.0	2.0
1.25	3.0	2.0
1.50	5.0	3.0
1.75	7.0	3.0
2.00	10.0	4.0
2.25	15.0	5.0

NOTE: * These figures are averages for slabs having 11 bars only since cracking had not occurred in slabs having 6 bars under the load calculated to give 0.75 of the working stress.

to be the appropriate value. Figure 10 shows the upper and lower limits of maximum crack width measured at any particular stress in both steels.

The load deflection curves were similar in all respects to those obtained for the beams, the warning of failure given by the Tentor reinforced slabs being excellent.

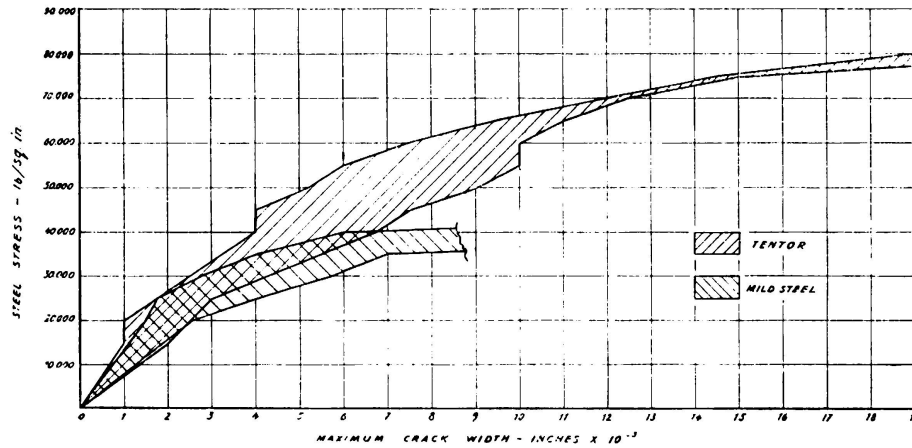

FIG. 10. Limits of maximum crack width in Tentor and mild steel reinforced slabs

Table 11 gives deflection-span ratios for various proportions of the working loads; a relationship with the cube strengths is evident. The deflections at working loads of the slabs having six bars are of little consequence since cracking was not fully developed at that stage.

TABLE 11

Deflection-span ratios at working loads and 50 per cent and 100 per cent overloads in 11 ft slabs

Mild steel reinforced				Tentor reinforced			
Beam	Working load	50 per cent overload	100 per cent overload	Beam	Working load	50 per cent overload	100 per cent overload
M. 11 (h)	$\frac{1}{860}$	$\frac{1}{550}$	$\frac{1}{330}$	T. 11 (h)	$\frac{1}{440}$	$\frac{1}{240}$	$\frac{1}{160}$
M. 11	$\frac{1}{700}$	$\frac{1}{400}$	$\frac{1}{270}$	T. 11	$\frac{1}{400}$	$\frac{1}{230}$	$\frac{1}{160}$
M. 6 (h)	$\frac{1}{3,000}$	$\frac{1}{1,100}$	$\frac{1}{600}$	T. 6 (h)	$\frac{1}{1,000}$	$\frac{1}{360}$	$\frac{1}{220}$
M. 6	$\frac{1}{3,000}$	$\frac{1}{1,300}$	$\frac{1}{630}$	T. 6	$\frac{1}{1,700}$	$\frac{1}{480}$	$\frac{1}{270}$

As in the tests of the long beams the Tentor reinforced slabs were capable of suffering such large deflections before failure that in no case was the actual failing load reached although the rate of flexure was so great that the reserves of strength could not have been large.

All the mild steel reinforced slabs failed by primary yield of the steel followed by secondary concrete crushing. Figures 8 and 9 illustrate respectively the conditions at maximum load of slabs with six mild steel and six Tentor bars. The mild steel reinforced slab has one well developed yield crack and the concrete has crushed over the full width. The Tentor reinforced slab has many well developed cracks, all of similar magnitude, but there is no sign of crushing.

TABLE 12

Factors of safety against flexural failure in 11 ft slabs

Mild steel reinforced			Tentor reinforced		
Beam	Failing * load (tons)	F. S. **	Beam	Failing * loads tons	F. S. **
M. 11 (h)	3.85	2.9	T. 11 (h)	4.35	2.8
M. 11	3.6	2.7	T. 11	4.15	2.6
M. 6 (h)	2.05	2.9	T. 6 (h)	2.25	2.7
M. 6	1.9	2.7	T. 6	2.3	2.8

NOTE: * Maximum loading achieved on each jack: this is slightly less than the failing load for Tentor reinforced specimens.

** Ratio of failing load plus dead load bending moment to working load plus dead load bending moment.

The overall factors of safety against flexural failure have been calculated as for the beams and appear in Table 12. It will be noticed that slightly higher factors of safety exist for mild steel reinforced slabs when the bars are hooked.

5. Conclusions

In drawing conclusions from the tests reported care must be taken that they are not applied too generally. With regard to the distribution of cracks the tests on beams and slabs showed a slightly better control by the deformed bar. In the beams the crack widths were considerably greater for Tentor than mild steel at equal proportions of their working stress. This disparity was much reduced in the slabs. In no case were the cracks at working stress of such a width that corrosion of the steel would be likely. It must be remembered however that the tests were carried out under static loading and that there was no cracking due to shrinkage. It seems reasonable to presume that since the mechanical

wedging between the Tentor bar deformations and the concrete becomes most effective after a small amount of relative displacement has taken place shrinkage cracking, which in many cases is much more severe than flexural cracking, would be controlled better by the deformed bar.

Deflections were naturally greater in Tentor reinforced members than in the mild steel reinforced member and in the slabs they were particularly severe especially in view of the fact that the measurements were instantaneous and did not include the effect of creep. The suggestions of the Institution of Structural Engineers committee include a limitation on the effective depth of Tentor reinforced simple slabs to $1/28$ of the span. Thus for a span of 10 ft the effective depth should not be less than 4.3 in. The measured effective depth of the slabs tested was slightly less, i. e. 4.2 in.

Warning of failure was good in the Tentor reinforced members and the overall factors of safety were not affected by the higher concrete working stresses. With regard to the suggestion that a higher permissible stress should be allowed for Tentor when used in slabs, this would seem to be quite safe in so far as failure is concerned (the same also applies to mild steel), but as far as working load conditions are concerned a more stringent limitation on the depth-span ratio would seem to be necessary in cases where the appearance of finishes has to be considered.

Bond stresses developed between Tentor bars and the concrete were extremely good where sufficient secondary reinforcement was provided and it may be concluded that the bars can be used without hooks.

6. Acknowledgments

The work described in this paper forms part of the research programme of the Cement and Concrete Association and is published with the permission of the Director. Acknowledgment is made to the Tentor Bar Co., Ltd., for the provision of the steel.

S U M M A R Y

Results are given for tests on beams and slabs reinforced with mild steel and Tentor deformed bar. For both types of steel the dimensions of members are kept constant and the areas of the steels are, as closely as possible, in the inverse ratio of their proposed working stresses. Details of cracking, deflection and ultimate strength are reported.

ZUSAMMENFASSUNG

Der Bericht enthält die Versuchsergebnisse von Eisenbetonbalken und -Platten, deren Bewehrung aus Weichstahl- und kalt verformten Tentor-Einlagen besteht. Die Betonabmessungen sind für beide Bewehrungsarten gleich und die Querschnittsflächen der Stahleinlagen so genau als möglich im umgekehrten Verhältnis zu den vorgesehenen Wirkungsspannungen gehalten worden. Es folgen Einzelheiten über Rissebildung, Durchbiegungen und Grenzspannungen.

RESUMO

O autor relata os resultados de ensaios comparativos efectuados com vigas e lages armadas com varões de aço macio e varões do tipo Tentor. Para cada ensaio com os dois tipos de armadura, mantiveram-se constantes as dimensões das secções e empregaram-se secções de aço inversamente proporcionais às tensões admissíveis respectivas. O autor indica também pormenores acerca da fissuração, das flechas e das tensões de rotura.

RÉSUMÉ

L'auteur rend compte des résultats d'essais comparatifs effectués sur des poutres et des dalles armées de barres rondes en acier doux et de barres Tentor. Au cours de chaque essais avec les deux types d'armature, les dimensions de la section étaient maintenues constantes et les sections de fer employées étaient inversement proportionnelles aux contraintes admissibles respectives. L'auteur donne également des détails au sujet de la fissuration, des flèches et des charges de rupture.

Leere Seite
Blank page
Page vide