

Theme II: Interaction problems in structures

Objektyp: **Group**

Zeitschrift: **IABSE congress report = Rapport du congrès AIPC = IVBH
Kongressbericht**

Band (Jahr): **9 (1972)**

PDF erstellt am: **21.07.2024**

Nutzungsbedingungen

Die ETH-Bibliothek ist Anbieterin der digitalisierten Zeitschriften. Sie besitzt keine Urheberrechte an den Inhalten der Zeitschriften. Die Rechte liegen in der Regel bei den Herausgebern.

Die auf der Plattform e-periodica veröffentlichten Dokumente stehen für nicht-kommerzielle Zwecke in Lehre und Forschung sowie für die private Nutzung frei zur Verfügung. Einzelne Dateien oder Ausdrucke aus diesem Angebot können zusammen mit diesen Nutzungsbedingungen und den korrekten Herkunftsbezeichnungen weitergegeben werden.

Das Veröffentlichen von Bildern in Print- und Online-Publikationen ist nur mit vorheriger Genehmigung der Rechteinhaber erlaubt. Die systematische Speicherung von Teilen des elektronischen Angebots auf anderen Servern bedarf ebenfalls des schriftlichen Einverständnisses der Rechteinhaber.

Haftungsausschluss

Alle Angaben erfolgen ohne Gewähr für Vollständigkeit oder Richtigkeit. Es wird keine Haftung übernommen für Schäden durch die Verwendung von Informationen aus diesem Online-Angebot oder durch das Fehlen von Informationen. Dies gilt auch für Inhalte Dritter, die über dieses Angebot zugänglich sind.

IIa

Interaction of different Materials

Interaction de matériaux différents

Wechselwirkung zwischen verschiedenen Materialien

C.F. MCDEVITT

I.M. VIEST

Bethlehem Steel Corporation
Bethlehem, Pa., U.S.A.

This preliminary report outlines the present state of the art of combining steel with other materials to form useful structural components. Its purpose is to delineate the topic for participants in the discussion. Hopefully, the contributions to the prepared and free discussions together with this report will provide an authoritative worldwide survey of the topic as of 1972.

Because of the broad nature of the topic, the report relies heavily on former summaries that are readily available and is supplemented by a substantial, although by no means exhaustive, bibliography. The great predominance of English references reflects the authors' area of familiarity. The authors would welcome contributions that would correct this deficiency.

The topic is divided into seven subtopics: composite steel-concrete beams, concrete encased steel beams, steel-concrete columns, hybrid beams, prestressed steel beams, composite plate components and cable-stayed bridges. While the contributions should be generally limited to these seven subtopics, examples of promising new combinations of steel with other materials in the form of structural components will be, of course, welcome.

Finally, the authors realize that in a paper of this broad nature there must be errors and omissions of important facts. They would, therefore, welcome any corrections and supplements as well as contributions based on new developments.

COMPOSITE STEEL CONCRETE BEAMS

Only beams with mechanical connectors will be included in this discussion.

In 1921, Julius Kahn of Detroit applied for a patent on composite beams in which the natural bond between the rolled steel beam and the concrete encasement was augmented by shearing prongs in the edges of the top flange of the rolled section and bending them upward to project into the slab. This was probably the birth of the mechanical shear connector which, as it turned out later, became an essential component of the composite beam as we know it today. A number of experimental studies carried out during the 20's and early 30's, some of which were discussed at the First IABSE Congress (1), were soon supplemented by a number of practical applications (2) (3) (4) (5) although some designers of the early bridges with shear connectors, like the George Washington Bridge in New York, did not count on composite action (6). The continued use of composite bridge construction in the United States led to the adoption of general specification provisions for this type of design in 1944 and to further intensive research which culminated in the development of practical design rules for shear connectors. This, combined with the introduction of the stud shear connector in the middle 50's, provided such a stimulus that by the end of the decade composite design became an everyday technique in the field of bridges.

The developments in the building field lagged considerably behind. Even though the literature contains a few earlier examples, the beginnings of a systematic and continuous application of composite design to buildings in the United States may be traced to the late 50's (7) (8) and a widespread use of the method came only in the 60's after the codification of design rules in 1961. Today, composite construction is an indispensable tool of the structural engineer. In bridge work, it is the major technique for medium spans and in buildings it is one of the primary structural systems for multistory construction.

Considerable body of research information has accumulated over the years. The following discussion will be concerned primarily with the developments of the past decade. For a review of investigations carried out prior to 1960 the reader is referred to an earlier paper by Viest (9) and to a somewhat more limited survey of the period 1940-1966 by Davies (10). An excellent discussion of the behavior of a simple composite section and of shear connectors was presented by Chapman (11).

Shear Connectors

While composite beams with mechanical connectors came into use in the 1930's, definite rules for the design of connectors appeared in widely used specifications only in the middle of the 1950's (12) (13). They were based primarily on static tests and were quite conservative so that there was no need for a separate consideration of fatigue.

The American bridge specifications (13) and, later, the tentative recommendations for buildings of the Joint ASCE-ACI Committee on Composite Construction (14) based the design of connectors on the concept of limiting the slip between the slab and the beam. However, extensive tests of push-out specimens and composite beams carried out at Lehigh University in the late 50's (15) showed that such a limitation was unnecessary: composite beams developed the

full flexural capacity of the cross section as long as the sum of the ultimate strengths of the individual connectors was at least equal to the total horizontal shear. On the basis of these studies, the design of connectors was based on their ultimate strength and substantially higher allowable loads for connectors were adopted by the AISC Specification in 1961 (16). Extensive studies of connectors were also carried out at Imperial College at the University of London (17) (18) during the late 50's and early 60's. These studies led to essentially the same conclusions as the work at Lehigh University and formed the basis for the British Standard Code of Practice for composite building design CP117: Part 1 (19). Both the American and the British specifications permitted uniform spacing of connectors because tests had shown plastic redistribution of forces among the connectors prior to their failure.

All of the studies which led to the adoption of the new design rules were based on tests conducted with normal weight concrete. This limitation was expressed clearly in the 1963 edition of the AISC Specification (20) which referred to "concrete made with ASTM C33 aggregates". No design rules were available for connectors embedded in lightweight aggregate concrete. An early recognition of the need to provide information in this area led to experimental investigations first at the University of Colorado (21) and later at the University of Missouri (22) (23) and Lehigh University where commercial tests were conducted on a number of proprietary products. These early studies were generally limited in scope. They not only did not show any clear trends but also appeared to lead occasionally to contradictory results. A more systematic series of tests of small scale beams in Australia (24) indicated a decrease of connector strength for specimens with lightweight concrete. To resolve the problem, two systematic studies were initiated in 1968, one at Lehigh University and the other at the University of Missouri. The results (25) (26) have shown conclusively that the strength of shear connectors in lightweight aggregate concrete is lower than the strength of connectors in concrete made with normal weight aggregate. A formula has been developed for estimating the strength as a function of the strength of concrete, stud area and the modulus of elasticity of concrete (25).

In order to be able to utilize in the design of bridges the improved knowledge regarding the static strength of connectors, researchers on both sides of the Atlantic set out to examine fatigue strength of shear connectors. Initial tests at Lehigh University (27), carried out principally on push-out specimens, were followed by a series of small-scale beam tests (28) and by tests of seven full-size beams, each thirty-six feet long, at the University of Texas (29). These American studies were completed with a comprehensive series of push-out tests at Lehigh University (30) that resulted in a design procedure adopted by the AASHTO Bridge Committee in 1967 (31). The procedure was noteworthy for its simplicity. It based fatigue design on the concept of stress range, that is the difference between the maximum and minimum stress rather than on the common engineering concept of stress ratio. The concept of stress range not only simplified the design but also led to uniform spacing of connectors, a feature particularly desirable from the standpoint of fabrication.

The work in the United States was concerned principally with stud shear connectors. Only a limited effort was devoted to

channels. On the other hand, British fatigue studies involved three types of connectors: studs, channels and rigid bars with hooks (32) (33) (34) (35). Their work also came to a successful conclusion in 1967 by the adoption of design rules for composite bridges CP117: Part 2 (36).

Numerous additional studies of both the static and fatigue strength of connectors have been completed or are still in progress. A considerable effort is being channeled into the study of fatigue strength of connectors in the negative moment regions of continuous beams (35) (37). The effect of the thickness of beam flange on the strengths of stud connectors was investigated by Goble (38) who found that for flange thicknesses less than about 0.4 times the stud diameter, the strength of the joint depends on the thickness of the flange. The effect of welded studs on fatigue strength of the tension flange was studied at the University of Illinois (39). The research teams at Imperial College (18) and the University of Missouri (40) contributed studies of the effect of a concrete haunch on the strength of connectors. Robinson and Fisher addressed themselves to the problem of the design of connectors placed in the troughs of a corrugated metal deck (41) (42). Numerous investigators in various parts of the world have recently investigated methods of connecting precast slabs to the steel beams (43) (44) (45). Investigations of the replacement of mechanical connectors with epoxy adhesives were studied both in the laboratories (46) (47) and in the field (47). Gogoi (48) and Toprac (49) found that the so-called checkerèd plate, that is a plate with rolled-in protrusions developed to produce a slip-resistant surface, is not particularly effective as a shear connection.

Beams

While the elastic behavior of composite beams was well established by the end of the 1950's and, furthermore, adequate theories were available at that time for computing the ultimate flexural strength of a composite beam with complete interaction, the post-elastic behavior needed further studies. Considerable progress was made during the past 10 years through extensive investigations carried out primarily at Lehigh University, Imperial College, the University of Missouri and Cambridge University.

Among the numerous studies concerned with ultimate strength, one of the most significant new contributions to the knowledge was the development of a theory of the ultimate strength of beams with inadequate shear connection (15). While in itself this theory was of limited practical usefulness, it established the lowest number of shear connectors necessary to develop fully the flexural strength of the beam cross-section and thus provided a rational basis for the design of connectors. This, and the adoption in Great Britain of a purely ultimate strength procedure for the design of composite beams for buildings (19), represent the most significant practical impact of the improved knowledge of the strength and behavior of composite beams.

Systematic investigations of the behavior of composite beams at all loads up to failure were made possible by the development of inelastic analyses at the University of Illinois (50) (53),

University of Missouri (51) and Imperial College (52). The analyses were based on the following assumptions:

1. Strains in the slab and beam are distributed linearly.
2. Deflections of the slab and beam are equal at all points along the span.
3. Concrete has no tensile strength.
4. Compression stress-strain relationship of concrete is trapezoidal.
5. Stress-strain relationship for steel is either trapezoidal (50) (51) or bilinear with the slope of both lines larger than zero (52).
6. Slab and beams are interconnected with either discrete shear connectors (50) (51) or a continuous shear connection (52).
7. The load-slip relationship, obtained by fitting the results of push-out tests, is either a smooth curve (51) (52) or a three-sided polynomial (50).

All three analyses were programmed for computer solutions and their results were found to be in reasonable agreement with the results of tests of composite beams. The investigators at Imperial College used their program to study the effects of a large number of variables on the behavior of composite beams; the results (52) were used to prepare the British Code of Practice CP117: Part 1 (19). The Missouri program was utilized in studies of the behavior of composite beams with lightweight aggregate concrete (26).

All of the above described studies of beams were concerned with simple spans. Substantial studies of continuous beams were carried out in England (54) (55) (56) and in the United States (57). All of them reached the conclusion that continuous composite beams with longitudinal reinforcement in the region of negative moments can be analyzed adequately by simple plastic theory. However, they warned that there is a need for adequate transverse reinforcement in the slab and that further studies are needed of compression flange buckling at the interior support.

Among the numerous other studies of composite beams, Barnard (58) investigated the effect of the shape of the stress block on the ultimate flexural capacity of composite beams; Mackey and Wong (59), Lee (60), Severn (61) and Adekola (62) studied the effective slab width; Manus (63) addressed himself to the strength of composite beams in torsion; Zuk (64) and Berwanger (65) reported on studies of thermal and shrinkage effects; and Daniels and Fisher (66) reported on tests of composite beams with simulated moving loads. Finally, prestressing of slabs in the negative moment regions has received considerable attention (44) (67).

Other Types of Steel Section

Occasionally, steel beams other than the customary rolled and welded shapes have been used compositely with the slab. Open-web

joists, castellated beams and inverted T-beams fall into this category.

The first recorded tests of composite open-web joists were made by Lembeck in 1965 at Washington University in St. Louis (68). The web bars of these joists were extended above the compression cord into the slab to serve as shear connectors. Further tests were made by Wang and Kaley (69) who tested open-web joists with a concrete slab keyed into a top cord formed into a dovetail-shaped trough. The third series of tests was carried out at Washington University by Tide and Galambos (70) on specimens with 3/8" diameter stud shear connectors. In all of these tests a high degree of interaction was observed, but the three series were too limited to permit any general conclusions. The work at Washington University is being continued for the purpose of developing general design recommendations, since open-web joists are used extensively in multi-story buildings.

Encased composite castellated beams were tested by Wong at Imperial College in 1957 (71), where it was found that reinforced encasement strengthened the webs of castellated sections. Encased composite castellated beams were used in the construction of the mechanical engineering laboratory building at Imperial College of the University of London (72); castellated composite beams were used in a three-span continuous bridge over the Mongaturanga River in New Zealand. In a 21-story office building in Seattle (73), reinforcing bars were welded to the top flanges of the castellated beams and then bent up to act as shear connectors. Larnach and Park (74) tested castellated composite beams with spiral shear connectors. Giriyappa (73) developed a simplified method of analyzing castellated composite beams that appears to be satisfactory for design purposes and tested two hybrid castellated composite beams with the bottom portions of the beams made of A441 steel and the top portions of A36 steel.

Inverted T-sections with the top few inches of the web embedded in the concrete slab and connected to the slab through stud shear connectors were used in tests of composite beams at the University of Texas (49) (75). Similar steel sections were used by McDermott, who tested prefabricated simple span bridge units (76) (77). Inverted T-sections were used in the construction of a 140 foot long, two-span continuous bridge in Kansas (78) (79).

CONCRETE ENCASED STEEL BEAMS

Composite steel I-beams encased in concrete may be classified into three categories: infilled beams, partially encased beams and fully encased beams. Infilled beams are steel I-beams transformed into rectangular sections by filling with concrete the spaces between their flanges on both sides of the web. They have been used in research studies (80) (81). Partially encased steel I-beams, i.e., beams with their top flanges embedded in concrete, were tested in the 1930's (9) but soon were made obsolete by the more efficient composite beams with mechanical connectors. Hawkins (82) recently tested a partially encased beam and concluded that the increase in

strength and stiffness due to bond is unreliable because lateral shrinkage can markedly reduce bond strength. Thus, only fully encased beams - now normally referred to as encased beams - are still used in buildings, usually for architectural and rarely for fire-protection purposes. Even this use of fully encased beams is declining because of availability of more economical fireproofing systems.

The first test of a composite, fully encased beam made in Canada in 1923 was followed by tests in England, United States and Continental Europe. For a review of these and later tests, the reader is referred to Viest (9) and Shanmuganayagam (80). The early investigators attempted to determine the bond strength, since at working loads the interaction between the steel beam and the surrounding concrete resulted from natural bond between the two materials. However, the reported values varied widely (83) and no satisfactory direct answer was found.

Accordingly, the code-writing bodies were forced to follow an indirect approach. Both the 1965 British Code of Practice CP117: Part 1 (19) and the American 1969 AISC Specification (84) allow a fully encased beam without shear connectors to be designed as a composite beam using the ordinary elastic procedures - but the encasement must meet certain specific requirements that are believed to assure a satisfactory bond. The allowable bending stress is the same as the allowable stress for a steel beam without encasement. The British code makes allowances taking into consideration the stiffening effect of the concrete. The American specifications consider the steel beams as "compact" regardless of the dimensions of the steel sections. As for encasement requirements, both codes require complete, properly reinforced encasement although they differ in a number of specific details.

The AISC Specification also permits an alternate design procedure: the steel beam may be assumed to carry all live and dead loads at an allowable bending stress in excess of that permitted for bare steel beams. This alternate procedure, while not entirely rational, is based on a common engineering practice (85) and has simplicity as its principal advantage.

After a lapse of two decades, during which practically all research on composite beams was directed toward beams with mechanical connectors, the 1960's brought renewed interest in research on encased composite beams. The work included studies of stability and ultimate strength. Procter directed his attention to the questions of stability. His theoretical (86) and experimental (87) work on lateral-torsional stability showed that the encasement increases the rigidity of the beam to such an extent that there is little possibility of failure due to lateral-torsional instability. His experiments (81) led also to the finding that encasement substantially increases the shear capacity of beams without web stiffeners. His tests on encased beam-to-column connections (81) showed that the encasement had little effect on the strength of a beam connection to a column flange, but greatly increased the strength of a beam connection to a column web.

Shanmuganayagam (80) and Varghese, Radhakrishnan and Parmasivam (88) directed their attention toward the development of ultimate

strength equations for beams encased in normal weight concrete. Naghshineh and Bannister (89) tested beams encased in lightweight aggregate concrete and concluded that the behavior of simple span beams can be predicted adequately by the ordinary elastic theory based on a cracked section. They also found that all continuous beams failed due to shear after some moment redistribution had occurred. Wide shear cracks were observed on each side of the intermediate support. The effect of shear on the ultimate strength of encased beams was studied further by Shanmuganayagam (80) and Johnson (83), who reviewed earlier tests of simply supported beams by Wong (90), Shanmuganayagam (80) and a number of other researchers, and found that shear failure was present in all but one test. Johnson concluded that because of considerable uncertainty regarding the bond strength, any practical ultimate strength equations for encased beams must be based on their behavior after both bond failure and concrete cracking had occurred. On the other hand, Hawkins (82) concluded that the design of encased beams is best based on the moment at bond failure. Thus, it appears that the question of predicting the strength of a concrete encased steel beam remains unresolved and the ordinary elastic procedure required by the British and American codes is presently the best available method of design.

STEEL-CONCRETE COLUMNS

Three types of steel-concrete columns will be discussed: composite columns in which the steel column is connected to the adjacent wall in such a manner as to assure composite action between the wall and the column, concrete encased steel columns and concrete filled steel tubes. All three types have been used in buildings, although only the latter two can be considered common.

Composite Columns

Just as slabs supported on steel beams present an opportunity to realize economies through utilization of composite action between these two elements, a similar opportunity also exists with respect to walls and adjacent steel columns. Although this was pointed out by Ros (91) in 1934 when he reported on tests of four composite columns, the concept has not made much headway. It has been revived recently by Gwylon (92) who proposed to utilize the end walls as wind bracing by connecting them to the steel columns with mechanical connectors. Furthermore, the current studies of the effect of cladding (93) on the stiffness and strength of the steel frame are likely to lead to the exploitation of this potential source of economy.

Concrete Encased Steel Columns

Encasing structural steel columns in concrete to increase their fire resistance became a widespread practice early in this century but the increase in stiffness and strength of the column resulting from the encasement was not taken into consideration until some years later.

The first tests of encased steel columns were made in 1908 by Burr in New York who observed that concrete encasement caused a considerable increase in strength. These, as well as other early

tests, were referred to by Stevens (94) and summarized by Laredo and Bard (95). Made on relatively short columns loaded axially, they showed that the load capacity of an encased column was equal to the sum of strengths of the steel and the effective concrete sections. None of the early tests were made on eccentrically loaded columns and this was reflected in the code provisions. To this day, the ACI Building Code (96) requirements for encased columns are limited to axial loads. In Great Britain, the 1948 edition of British Standard BS449 (97) was the first to recognize the increased column stiffness by permitting an increase in the least radius of gyration for an encased column. The 1959 edition recognized the increased strength of encased columns by permitting the design assumption that the concrete carries load over its entire cross section.

The beginnings of modern research on encased columns may be traced to Stevens (94) who summarized the results of tests of axially and eccentrically loaded encased columns made at the Building Research Station in Great Britain. Most of the 35 axially loaded columns were encased in normal weight concrete, but some were encased in lightweight concrete. The type of concrete, whether normal or lightweight, had no effect on the strength of the column. Three modes of failure were observed: crushing of concrete and yielding of steel in compression near the top of the column for slenderness ratios less than 60, crushing of concrete on one face near the middle of the column for slenderness ratios between 60 and 120, and failure due to tensile cracking on one face of the column for slenderness ratios greater than 120. Stevens concluded that the behavior of axially loaded encased columns is similar to that of reinforced concrete columns.

Twenty-four encased columns were eccentrically loaded in such a way as to cause bending about the minor axis. The behavior and failure modes of these columns were again similar to those observed for reinforced concrete columns. On the basis of these tests, Stevens suggested formulas and rules for the design of encased columns and compared his proposals with the procedures then prescribed by the British codes BS449 for steel (97) and CP114 for concrete (98).

Additional tests of encased columns were reported by Jones and Rizk (99), who investigated the effect of longitudinal and lateral reinforcement in the concrete encasement and the effect of slenderness on the behavior and strength of axially loaded columns; and by Procter (100) who investigated the possibility of lateral-torsional failure in eccentrically loaded columns. Wanatabe in Japan, and Laredo and Bard in France (95) studied the question of bond between the steel section and the encasement and found no weakness in this regard.

Further studies were concerned primarily with analytical developments. Bondale (101) presented a rigorous treatment of column stability and compared it with the results of tests of 16 encased columns. A good correlation was found between the experiments and the theory. In 1967, Basu (102) reported the development at Imperial College of a computer program for calculation of the ultimate loads of eccentrically loaded rectangular columns based on classic theory of inelastic column buckling. Again, good agreement was observed between the failure loads predicted by the computer

program and the results of 30 tests of encased columns made at the Building Research Station and at Imperial College. One year later, Basu and Hill (103) reported the development of a new computer program based on the actual equilibrium shape of the deflected column rather than on the assumed cosine wave assumption of the deflection shape used in the earlier program. Furthermore, the new program was applicable to columns with unequal eccentricities at each of their ends. The differences between the loads computed with these two programs were found to be small and it was concluded that the earlier simpler program was sufficiently accurate for practical purposes.

Another computer program for calculating the ultimate load carrying capacity of axially and eccentrically loaded columns was developed by Roderick and Rodgers (104) from three basic assumptions: that plane sections remain plane, that there is no slip between the concrete and the steel, and that the concrete cracks and carries no load when it is subjected to tension. Roderick and Rodgers compared their computer solutions with the results of full-size tests reported by Stevens (94) and small-scale column tests made by the authors at the University of Sydney.

It would seem then that the data and the tools necessary for the development of improved design methods for concrete encased steel columns are available and that improvements of code provisions are in order.

Concrete Filled Steel Tubes

Most of the concrete filled steel tubes that were used at the beginning of this century were made with circular tubes. Square and rectangular tubing entered the market relatively recently. This has been reflected in research; most of the tests have been made on columns of circular cross section.

The experimental and theoretical work on concrete filled steel tubes carried out prior to 1967 was reviewed by Gardner and Jacobson (105). They developed equations for predicting the ultimate axial load carrying capacity of short columns and estimated buckling loads of long columns by the tangent modulus method. They also made a limited investigation of the effects of various end conditions. Gardner and Jacobson compared their results with allowable loads calculated using the formula given in the 1963 ACI Building Code and concluded that the magnitudes of loads allowed by this code should be reexamined for slenderness ratios less than 60 to take advantage of the increased strength offered by high yield strength steels. A test series of concrete filled spirally welded steel tubes loaded axially was reported by Gardner in 1968 (106). The strengths of these columns were found to be similar to those of columns made with seamless pipe. Extensive studies of concrete filled steel tubes of both circular and square cross sections were reported by Furlong in two papers (107) (108). On the basis of 52 tests, Furlong developed an interaction equation for combined axial load and bending moment. On the basis of his tests and tests reported by Kloppel and Goder, by Sims and Salani, and by the U. S. National Bureau of Standards, Furlong proposed design equations that have been included in the 1970 draft of the ACI Building Code (109).

Further analytical work was reported in 1969 by Neogi, Sen and Chapman (110) who developed a computer program for predicting the maximum loads of axially loaded straight columns by the tangent modulus approach and for predicting the load deflection curves and the maximum loads for eccentrically loaded concrete filled tubular columns of both circular and rectangular cross sections. They compared the analytical predictions with the results of tests carried out at Imperial College and tests made by Kato and Kanatani in Japan and concluded that the program, based on uniaxial strength of concrete, is conservative for shorter columns but quite accurate for circular columns with length-to-depth ratios of 15 or more.

The structural response of concrete filled tubular columns seems to be well in hand. However, it appears that additional information may be needed on their fire resistance. The Lally Company, which has been manufacturing concrete filled tubular columns for about 60 years, reports that the fire resistance of an unprotected steel tube filled with concrete is about 3 to 4 times as high as that of the steel tube alone (105). On the other hand, Furlong (107) reported that Professor Kordina who conducted fire tests in Germany has warned that entrapped moisture can cause the steel shell of the concrete filled tube to explode during a fire. And finally, Neogi, Sen and Chapman (110) recently pointed out that the degree of fire resistance of concrete filled tubes has not yet been established and that the possibility of tubes bursting due to freezing should also be investigated.

HYBRID BEAMS

A hybrid beam is defined as a fabricated beam which has a stronger grade of steel in its flanges than in its web. Its behavior differs from that of a homogeneous steel beam of the same dimensions in that yielding starts in the web rather than in the flanges and its plastic moment capacity is lower. However, the yielding of the web alone does not result in large permanent deformations and the strength differential is small in relation to the differential between the yield points of the web and flange steels.

While steels of different yield strengths have been used in the same girder for several decades, the concept of a hybrid beam was developed only in the middle fifties. The term "hybrid beam" was advanced by Haaijer (111), who wrote the following in 1961:

"It is intuitively obvious...that the higher strength steels will be more effective in the flanges than in the web. Hybrid steel beams constructed by welding higher strength steel flanges to lower strength steel webs should, therefore, be more economical."

The development of the concept was followed by several research studies carried out principally by Professor Toprac at the University of Texas and by Schilling at the Monroeville laboratories of the United States Steel Corporation. The studies culminated in design recommendations published in 1968 as the report of a subcommittee of the Joint ASCE-AASHO Committee on Flexural Members (112).

The report summarized the work completed as of that date and referred to 32 principal papers published on the subject. There was sufficient theoretical and experimental information available from these papers and from unpublished results of research in progress for the subcommittee to develop conservative guidelines for the design of symmetrical noncomposite hybrid beams and for the design of composite beams formed by connecting a reinforced concrete slab to the top flange of a hybrid steel section.

The subcommittee concluded that composite and noncomposite hybrid beams can be designed efficiently using an allowable flange stress based on the moment required to initiate flange yielding. This allowable flange stress is a function of the beam dimensions and the ratio of the yield strengths of the two steels, and is slightly lower than the allowable stress normally used for the flange steel. Milek (113) has indicated that this reduction would be about 7% for plate girders of average proportions which have ASTM A-514 flanges (100 ksi) and ASTM A-36 webs (36 ksi). The bending stress in the web does not have to be checked when this reduced allowable flange stress is used. However, the shear stress in the web must be limited to the normal allowable stress for the web steel. The suggested allowable width-to-thickness ratios and stiffener requirements were generally the same as the AISC and AASHTO provisions for homogeneous beams and girders. The available fatigue data indicated that these hybrid beams can generally be designed for fatigue as if they were made entirely of the grade of steel used in the flanges.

The report also pointed out some problem areas where more research work would be helpful, including plastic design, lateral buckling and tension field action.

A number of additional papers (114) (115) (116) (117) reporting the results of research have been published since the issuance of the Joint Committee report. Schilling (114) published the detailed studies which resulted in the design equation for the reduced allowable flange stress used in the Joint Committee report. Carskaddan (115) reported on theoretical and experimental studies aimed at determining the maximum acceptable slenderness ratios for unstiffened webs. Lew, Natarajan and Toprac (116) reported the results of extensive static tests carried out at the University of Texas over a number of years. The results of fatigue tests of some fifty hybrid girders carried out at the same institution are now being made ready for publication. Finally, Carskaddan reported in 1969 (117) on the effect of bending stresses on the maximum permissible web slenderness of vertically stiffened webs.

The Joint Committee report led quickly to the adoption of design specifications for highway bridges and for buildings: The American Association of State Highway Officials adopted provisions for both noncomposite and composite hybrid girders in 1969 (118) and the American Institute of Steel Construction adopted provisions for noncomposite hybrid plate girders in 1969 (84). Simultaneously, designers started using the hybrid concept in the design of various steel structures, particularly for highway bridges. Some of them are now in use and more are under construction. One of the hybrid girder bridges, designed by the Texas State Highway Department, was among the winners in the 1970 Award Program of the Lincoln Arc

Welding Foundation. The structure included three-span continuous, 360 feet long, hybrid girders with A-441 flanges (50 ksi) and A-36 webs (36 ksi).

Milek (113) discussed the changes in the AISC Specification and the way they affected plate girder design. He pointed out that under the 1969 AISC Specification, a designer has the option of designing a plate girder either as a hybrid beam or as a homogeneous girder having a thin web which is designed utilizing tension field action. Another discussion of current design methods and trends in the analysis and design of large, thin-web plate girders and hybrid beams was published by Massonnet (119). Further studies of hybrid beams under repeated loads are reported to be underway in Japan (120). However, it appears that up to now the practical applications of hybrid beams and girders have been limited to those in the United States.

PRESTRESSED STEEL COMPONENTS

For the purposes of this discussion, prestressed steel components are divided into three categories: components prestressed with high strength tendons, hybrid beams prestressed internally and Preflex beams. This classification originated in a report titled "Development and Use of Prestressed Steel Flexural Members" prepared by a subcommittee of the Joint ASCE-AASHTO Committee on Flexural Members and published in 1968 (121). The report, documented with 46 references, summarizes the subject of prestressed steel components and needs no further amplification at this time. Therefore, this discussion is limited to certain general remarks and simple descriptions of these three categories. The descriptions were taken from the above report.

The general subject of prestressed steel has been covered in a comprehensive treatise by Ferjencik and Tochacek (122), published in 1966. The book includes a worldwide survey of the state of the art, a thorough classification of prestressed steel, design methods based on limit states and a wealth of practical details. Two items are of particular interest in this discussion: (a) most of the examples of practical applications indicate that prestressing is used more for the overall structure than for individual components and (b) prestressed steel has been getting considerable attention in the Soviet Union in both the areas of research studies and practical applications.

The more limited subject of prestressed steel bridges was discussed at the Seventh Congress of IABSE. It attracted four papers which dealt with strengthening old bridges (123), an experimental investigation of continuous beams (124), examples of recently completed structures (125) and structural safety (126).

It may be noted that even though several noteworthy structures have been built with prestressed components during the past twenty years and although their design does not seem to be handicapped by any substantial gaps in technical knowledge, the use of prestressed steel components has been limited. This lack of market penetration

suggests that prestressed steel components usually do not offer an economic advantage.

The two basic methods available for prestressing steel components with high strength steel tendons can be illustrated by means of simply supported I-beams. In one method, the tendons are placed below the centroid of the beam and are attached to the beam at its ends. In this case a constant prestressing force results. The second method is to attach the tendons at the centroid of the beam above the two supports and drape the tendons by providing hold-downs below the centroid at locations between the supports. In this case a variable eccentricity results. Numerous variations and combinations of these two methods have been used for beams, girders, trusses, frames and arches. High strength wires, cables, ropes and bars have been used as tendons. Steel components prestressed with tendons have been used for bridges, crane runways, roofs and other structures. They appear to be the most commonly used prestressed components.

The basic principle of internally prestressing hybrid beams involves the application of tension to a high strength cover plate to induce favorable prestress into the remaining portion of the beam which is made out of an ordinary grade of structural steel. There are two possible ways of prestressing hybrid beams. One is by applying a direct tensile force to a high strength plate, which is welded while under stress, to an unstressed T or I section. The second method is to deflect a structural steel I-beam and weld high strength cover plates to the flanges of the beam while the beam is in the deflected position. In both methods the release of the external load results in the desired prestress. The principal advantage of such prestressing is that it permits a more efficient use of hybrid sections within the limitations established by codes and specifications for the elastic design of homogeneous members. However, the more liberal design method for hybrid beams which was described in the preceding section of this report is likely to make prestressed hybrid beams uneconomical. Beams prestressed by this technique were used in a highway bridge built in 1962 (127). The authors are not aware of any other applications.

In a Preflex beam, the bottom flange of a steel section is encased in concrete subjected to permanent compressive stress. During fabrication, a rolled or welded high strength steel I-beam is deflected in the direction of design load application. The intensities of the deflecting forces are high enough to produce stresses at least equal to the maximum design stresses. Prior to predeflection, the steel beam is cambered and shear connectors are welded to the tension flange. While the steel core is maintained in the deflected position, the tension flange is embedded in high strength concrete. After the concrete on the tension flange has cured, it is precompressed by releasing the external loads. Preflex beams are transported and erected similarly to steel beams. Their webs and top flanges are encased in concrete cast monolithically with the floor slab. This predeflecting technique has been used since the early 1950's, particularly in Belgium where Preflex beams were developed as a proprietary product (128). The technique makes it possible to use concrete encased high strength steel beams in cases where deflection or cracking of the concrete would be excessive. Preflex beams have been used primarily in structures where shallow construction depths were required.

COMPOSITE PLATE COMPONENTS

Three types of composite plate components are of interest in this discussion: composite concrete-steel plates, composite form-reinforced concrete slabs and sandwich panels.

Composite Concrete-Steel Plates

Composite concrete-steel plates have been used in a number of specialized applications, such as storage tanks, pressure vessels and blast resistant hatch covers. They have also been used as composite liners for concrete walls.

One type of composite plate consists of a circular concrete slab cast in a steel "dish". This dish is formed by welding a steel ring around the periphery of a steel plate. Beadle, Dally and Riley (129) tested concrete infilled circular steel plates and concluded that concrete confined by a steel ring can be used to greatly increase the rigidity as well as the load carrying capacity of circular steel plates. Theoretical and experimental studies of composite plates of this type are in progress at the University of New Mexico (120).

Another type of composite plate is comprised of a steel plate connected by stud connectors to a concrete slab. This type of composite plate has been tested at the University of Illinois (130) and at Imperial College (49). Most of the tests were made with concentrated loads on one-way slab strips, both simple and continuous. Even after bond failure, there was still a high degree of interaction between the plates and the slabs. The stud connectors also served as shear reinforcement. Wide spacing of connectors resulted in shear failures.

In commenting on the results of Gogoi's test of a two-way slab at Imperial College, Johnson (131) concluded that two-way composite plates should show greater promise than one-way composite plates because shear forces are lower. He suggested that ultimate strength design would lead to greater economy when composite plates are used in buildings. He also suggested that the plate membrane strength could be utilized in order to avoid shoring during construction. Plates of this type, developed by Robinson, are being used in France for orthotropic bridge floors (132). The Tarcanville suspension bridge, an overpass over the railroad tracks near Paris (133), and other structures serve as examples of practical applications.

Composite Form-Reinforced Concrete Slabs

Light gage steel forms have been used as formwork for concrete slabs in high-rise buildings for many years. Removable steel pans were developed for forming ribbed and waffle concrete slabs. They were soon followed by various types of corrugated sheet and ribbed panel forms which were left in place even though they were not intended to serve a structural purpose after the concrete had hardened. These forms are characterized by their shallow and narrow corrugations. Another type of floor system was developed in which a steel cellular flooring is the load-carrying element not only during construction but also after the completion of the floor. The top of

this cellular decking is usually covered with lightweight concrete of low strength which serves only as a finishing material.

More recently, a number of manufacturers in the United States have developed and marketed corrugated sheet or ribbed panel forms which interact with the concrete slab to form a composite floor system, often referred to as a form-reinforced concrete slab because the steel form acts as a one-way reinforcement. Some manufacturers are using proprietary form profiles to prevent separation of the slab from the deck form and to promote bond between the concrete and the steel. Others have achieved a mechanical shear connection by welding wires to the top of the steel deck form or by rolling indentations or embossments into the top flanges or webs of the forms. The beam bending and shear tests made by or for the manufacturers during development of their steel forms have demonstrated that these floor slabs respond to load as composite units and that they can be designed for one-way bending by conventional methods.

Ekberg and Schuster described the state of the art of using form-reinforced concrete slabs in buildings in a paper included in the final report of the Eighth IABSE Congress (134). They have been engaged in an extensive theoretical and experimental investigation of steel decking as reinforcement for concrete slabs at Iowa State University. Laboratory tests have shown that most of the steel deck-reinforced concrete slab systems exhibit a shear-bond type failure. Ekberg and Schuster have developed a semi-empirical equation relating the ultimate strength of a composite metal deck form to the compressive strength of concrete, the percentage of steel, and several pertinent dimensions of the form and slab.

Sandwich Panels

A structural sandwich is a laminated construction comprised of a combination of alternating dissimilar, simple or composite materials assembled in such a way that the properties of each contribute to the total usefulness of the entire assembly (135). The key to the structural sandwich concept is that the total assembly is superior to the sum of its components through multiple interrelated functions of each component.

The basic concepts and principles of sandwich construction are by no means a recent development. About 1820, Duleau discovered that rigidly connected spaced facings were far stiffer than the sum of the stiffnesses of the individual facings. Within 50 years, the first commercially successful sandwich was introduced in the form of corrugated cardboard. This development emphasized an essential factor of all practical construction; the connection system must be simple and inexpensive, for on it depends the integrity of the sandwich (151).

The aircraft industries' need for a lightweight structural element was the catalyst required for the development of sandwich panels. In 1924, Von Karman proposed several skin and core combinations suitable for aircraft construction. This scheme was made practical with the development of high-strength glues for wood and, in 1937, the De Havilland Albatross airplane utilized a monocoque fuselage formed by bonding thin cedar plywood to both surfaces of a balsa wood core.

At about the same time, lightweight cellular cores were developed. De Bruyne's work in this field was especially important through the development of a practical fabricating system for a hexagonal honeycomb core (147). But even with these developments, further progress was limited by the availability of suitable adhesives. Metal-to-metal sandwiches were not practical until 1944 when vinyl phenolic adhesives were developed. Since that time, the development of structural sandwiches has continued through technical advances in both materials and adhesives. Many of the test procedures developed for adhesives and sandwich constructions have been standardized by ASTM (135). Today, nearly any combination of materials can be fabricated if the end product can be justified by practical and economic needs.

Most of the early sandwich panel development efforts were directed toward the aircraft industry. Strength-to-weight criteria were paramount; cost was often of second consideration. In a search for new outlets, the manufacturers of such panels turned to building construction as a potential large-volume market. Here, the design criteria are different; cost and ease of in-place installation are of prime importance. Interest in this new market area was reflected in three ASTM Symposia held between 1951 and 1959 (136) (137) (138) and a research correlation conference held in 1960 (150).

However, the growth of sandwich panels in building construction has been slow. Sandwiches have been used somewhat, but their cost and the inflexibility of factory-produced components has limited these uses to curtain walls, doors and interior partitions. Most of the sandwich-type wall constructions have been built in place by multiple-layer construction. However, some are not sandwiches as defined earlier, for the components do not function as a total, integral assembly. Platts has discussed in detail the more promising core and face materials (151). As a general rule, face sheets are of relatively dense materials while cores are usually weak, lightweight materials serving the dual function of separating the face sheets and thermally and/or acoustically insulating the sandwich.

The interested reader should refer to the bibliography at the end of the paper which lists a few of the many references available on this subject. Of particular interest, Plantema summarized the available theoretical knowledge of sandwich panel bending strength and stability in 1966 (141). Non-English references not covered by Plantema may be found in books by Aleksandrov and Bruypper (142) and by Dundrova, Kovarik and Slapak (143). Furthermore, an excellent bibliography of British and American references was published by Allen in 1969 in which the analysis and design of sandwich panels is treated in engineering terms (144).

The complexities of sandwich panel design make computer solutions practical and desirable. Several computer programs may be found in a book by Hartsock (145). The computer program outlined in a paper by Smolenski and Krokosky (146) is aimed at optimum design in which simultaneous consideration is given to structural, acoustic, thermal and economic criteria.

Further references cite the development of structural sandwich panels for exterior load-bearing walls (153) (154) (155), floors (156) and roofs (157). Indications are that the structural sandwich panel can be a construction medium of the future. The needed

technology has been developed and applications are ready and waiting. Mass production and widespread acceptance may alleviate the remaining hurdle - relatively high cost compared to some standard constructions (154). It is expected that the current move toward mass produced housing and simplified building techniques may increase the use of sandwich panels in all types of building construction.

CABLE-STAYED BRIDGES

The last portion of this discussion differs somewhat from the preceding parts in that it deals with structures rather than components. It has been included because of the timeliness of the topic; until recently cable-stayed bridges have been built principally in Germany but now are spreading rapidly throughout the world.

There is no need to define the topic of cable-stayed bridges. Several excellent reviews have been written during the past few years (158) (159) (160) (161) (162) (163) and are readily available to the interested reader. Contributions on developments not included in any of the above references are particularly desired.

BIBLIOGRAPHY

For brevity, the titles of a number of professional societies have been abbreviated as follows:

ACI	American Concrete Institute
AISC	American Institute of Steel Construction
AISI	American Iron and Steel Institute
ASCE	American Society of Civil Engineers
ASTM	American Society for Testing and Materials
IABSE	International Association for Bridge and Structural Engineering

1. IABSE, Final Report, First Congress, 1932.
2. Knight, A. W., "The Design and Construction of Composite Slab and Girder Bridges," Journal, Institution of Engineers, Australia, 1934.
3. Paxson, G. S., "Loading Tests on Steel Deck Plate Girder Bridge with Integral Concrete Floor," Oregon Highway Department Technical Bulletin No. 3, 1934.
4. Kolm, R. C., "The Compound Action of Concrete Slabs and Rolled Steel Girders for Bridge Decking," Preliminary Publication, Second Congress, IABSE, 1936.
5. Krebitz, J., "Verbund zwischen vollwandigen Stahltragern und daruberliegender Fahrbahnplatte aus Eisenbeton durch Bugel," Beton and Eisen (Berlin), 1938.
6. Bowden, E. W., "Roadways on Bridges," Engineering News Record, 1938.
7. Hooper and Hotchkiss, "Record for Composite Construction," Engineering News Record, March 1960.
8. Leabu, V. F., "Composite Design with Lightweight Aggregates on Building Projects," AISC Engineering Journal, October 1965.
9. Viest, I. M., "Review of Research on Composite Steel-Concrete Beams," ASCE Journal of the Structural Division, June 1960.

10. Davies, C., "Steel-Concrete Composite Beams with Flexible Connectors - Survey of Research," Concrete (London), December 1967.
11. Chapman, J. C., "Composite Construction in Steel and Concrete - Behaviour of Composite Beams," Structural Engineer (London), April 1964.
12. "Verbundtrager-Strassenbrucken, Richtlinien fur die Berechnung und Ausbildung, DIN 1078," Die Bautechnik (Berlin), 1954.
13. American Association of State Highway Officials, "Standard Specifications for Highway Bridges," 7th Edition, 1957.
14. "Tentative Recommendations for the Design and Construction of Composite Beams and Girders for Buildings," ASCE Journal of the Structural Division, December 1960.
15. Slutter and Driscoll, "Flexural Strength of Steel-Concrete Composite Beams," ASCE Journal of the Structural Division, April 1965.
16. "Specification for the Design, Fabrication and Erection of Structural Steel for Buildings," AISC, 1961.
17. Chapman and Balakrishnan, "Experiments on Composite Beams," Structural Engineer (London), November 1964.
18. Chapman and Teraszkiewicz, "Research on Composite Construction at Imperial College," British Constructional Steelwork Association Proceedings, Conference on Steel Bridges, 1968.
19. CP117: Part 1, "Composite Construction in Structural Steel and Concrete, Simply Supported Beams in Buildings," British Standards Institution, 1965.
20. "Specification for the Design, Fabrication and Erection of Structural Steel for Bridges," AISC, 1963.
21. Chin, J., "Pushout Tests on Lightweight Composite Slabs," AISC Engineering Journal, October 1965.
22. Proctor, H., "Analytical and Experimental Study of Lightweight Concrete-Steel Composite Beams," University of Missouri M. S. Thesis, 1963.
23. Buttry, K. E., "Behavior of Stud Shear Connectors in Lightweight and Normal Weight Concrete," University of Missouri M. S. Thesis, 1965.
24. Roderick, Hawkins and Lim, "Behavior of Composite Steel and Lightweight Concrete Beams," Civil Engineering Transactions, Institution of Engineers, Australia, October 1967.
25. Ollgaard, Slutter and Fisher, "The Strength of Stud Shear Connectors in Lightweight and Normal Weight Concrete," Lehigh University, Fritz Engineering Laboratory Report No. 360.2.
26. McGarraugh, J. B., "Light Weight Concrete on Steel Composite Beams," University of Missouri, Columbia, 1970.
27. Thurlimann, B., "Fatigue and Static Tests of Stud Shear Connectors," ACI Journal, 1959.
28. King, Slutter and Driscoll, "Fatigue Strength of 1/2 Inch Diameter Stud Shear Connectors," Highway Research Record 103, 1965.
29. Toprac, A. A., "Fatigue Strength of 3/4 Inch Stud Shear Connectors," Highway Research Record 103, 1965.
30. Slutter and Fisher, "Fatigue Strength of Shear Connectors," AISI Steel Research for Construction, Bulletin 5, 1967.
31. American Association of State Highway Officials, "Interim Specifications, 1966-67," 1968.
32. Mainstone and Menzies, "Shear Connectors in Steel-Concrete Composite Beams for Bridges (1) Static and Fatigue Tests on Push-Out Specimens," Concrete (London), 1967.
33. Mainstone and Menzies, "Shear Connectors in Steel-Concrete Composite Beams for Bridges (2) Fatigue Tests on Beams," Concrete (London), 1967.
34. Mainstone, R. J., "Shear Connectors in Steel-Concrete Beams for Bridges and New CP 117, Part 2," Institution of Civil Engineers Proceedings, September 1967.
35. Teraszkiewicz, J. S., "Static and Fatigue Behaviour of Simply-Supported and Continuous Composite Beams of Steel and Concrete," Imperial College Ph. D. Thesis, 1967.

36. CP117: Part 2, "Composite Construction in Structural Steel and Concrete Beams for Bridges," British Standards Institution, 1967.
37. Daniels and Fisher, "Fatigue Behavior of Continuous Composite Beams," Highway Research Record 253, 1968.
38. Goble, G. G., "Shear Strength of Thin Flange Composite Specimens," AISC Engineering Journal, April 1968.
39. Selby, Stallmeyer and Munse, "Fatigue Tests of Plates and Beams with Stud Shear Connectors," Structural Research Series 270, University of Illinois, 1963.
40. Das and Baldwin, "Shear Connections in Haunched Composite Beams," University of Missouri, 1967.
41. Robinson, H., "Composite Beam Incorporating Cellular Steel Decking," ASCE Journal of the Structural Division, March 1969.
42. Fisher, J. W., "Design of Composite Beams with Formed Metal Deck," AISC Engineering Journal, July 1970.
43. Sattler, K., "Betrachtungen zu verschiedenen Problemen der Verbundbauweise (Hochstrassen)," IABSE, 7th Congress, Preliminary Publication, 1964.
44. Dubas, P., "Developments suisses recents en matiere de ponts mixtes acier-beton," Construzioni Metalliche, No. 1, 1969.
45. Ford, J. H., "Use of Precast, Prestressed Concrete for Bridge Decks," Purdue University M. S. Thesis, 1969.
46. Miklofsky and Gonsior, "Investigation of Physical Properties of Epoxy Bonding Compound for Composite Beam Bridge Construction," Highway Research Record 34, 1963.
47. Kriegh and Richard, "Epoxy-Bonded Composite T-Beams for Highway Bridges," University of Arizona, 1966.
48. Gogoi, S., "Interaction Phenomena in Composite Beams and Plates," Imperial College Ph. D. Thesis, 1964.
49. Toprac, A. A., "Strength of Three New Types of Composite Beams," AISI Steel Research for Construction Bulletin 2, 1965.
50. Dai and Siess, "Analytical Study of Composite Beams with Inelastic Shear Connection," University of Illinois, Structural Research Series 267, 1963.
51. Baldwin, Henry and Sweeney, "Study of Composite Bridge Stringers, Phase II," University of Missouri, 1965.
52. Yam and Chapman, "Inelastic Behavior of Simply Supported Composite Beams of Steel and Concrete," Proceedings, Institution of Civil Engineers, December 1968.
53. Dai, Thiruvengadam and Siess, "Inelastic Analysis of Composite Beams," Proceedings of ASCE Specialty Conference, University of Missouri, 1970.
54. Barnard and Johnson, "Plastic Behavior of Continuous Composite Beams," Proceedings, Institution of Civil Engineers, October 1965.
55. Johnson, Van Dalen and Kemp, "Ultimate Strength of Continuous Composite Beams," Proceedings, Conference on Structural Steelwork, British Constructional Steelwork Association, 1967.
56. Park, R., "Ultimate Strength of Continuous Composite T-Beams," Civil Engineering Transactions, Institution of Engineers, Australia, October 1967.
57. Daniels and Fisher, "Static Behavior of Continuous Composite Beams," Lehigh University, Fritz Engineering Laboratory Report 324.2, 1967.
58. Barnard, P. R., "Series of Tests on Simply Supported Composite Beams," ACI Journal, April 1965.
59. Mackey and Wong, "Effective Width of a Composite Tee-Beam Flange," Structural Engineer (London), September 1961.
60. Lee, J. A. N., "Effective Width of Tee Beams," Structural Engineer (London), January 1963.
61. Severn, R. T., "The Effective Width of T-Beams," Magazine of Concrete Research, June 1964.
62. Adekola, A. O., "Effective Widths of Composite Beams of Steel and Concrete," Structural Engineer (London), September 1968.

63. Manus, P. F., "Nonuniform Torsion of Composite Beams," ASCE Journal of the Structural Division, June 1969.
64. Zuk, W., "Thermal Behavior of Composite Bridges, Insulated and Uninsulated," Highway Research Record 76, 1965.
65. Berwanger, C., "Thermal Stresses in Composite Bridges," Proceedings of ASCE Specialty Conference, University of Missouri, 1970.
66. Daniels and Fisher, "Static Behavior of Composite Beams with Variable Load Position," Lehigh University, Fritz Engineering Laboratory Report 324.3, 1967.
67. Reagan and Krahl, "Behavior of Prestressed Composite Beams," ASCE Journal of the Structural Division, December 1967.
68. Lembeck, H. G., Jr., "Composite Design of Open Web Steel Joists," Washington University M. S. Thesis, St. Louis, 1965.
69. Wang and Kaley, "Composite Action of Concrete Slab and Open Web Joist," AISC Engineering Journal, January 1967.
70. Tide and Galambos, "Composite Open-Web Joists," AISC Engineering Journal, January 1970.
71. Wong, K. C. F., "Building Frames of Composite Construction," Imperial College Ph. D. Thesis, 1957.
72. Cassell, Chapman and Sparkes, "Observed Behavior of a Building of Composite Steel and Concrete Construction," Institution of Civil Engineers Proceedings, April 1966.
73. Giriappa, J., "Behavior of Composite Castellated Hybrid Beams," University of Missouri M. S. Thesis, 1966.
74. Larnach and Park, "Behavior Under Load of Six Castellated Composite T-Beams," Civil Engineering, March 1964.
75. Toprac and Eyre, "Composite Beams with a Hybrid Tee Steel Section," ASCE Journal of the Structural Division, October 1967.
76. McDermott, J. F., "Tests Evaluating Punching Shear Resistance of Prefabricated Composite Bridge Units Made with Inverted Steel T-Beams," Highway Research Record 103, 1965.
77. McDermott, J. F., "Prefabricated Composite Highway Bridge Units with Inverted Steel T-Beams," Highway Research Record 167, 1967.
78. Delameter, R. S., "Experimental Design for Short-Span Bridges," Modern Steel Construction, AISC, 1963.
79. "Composite Design Lowers County Bridge Costs," Engineering News Record, March 26, 1964.
80. Shanmuganayagam, V., "The Ultimate Strength of Simply Supported Encased Beams," Cambridge University M. S. Thesis, 1966.
81. Procter, A. N., "Composite Construction," Consulting Engineer, February 1969.
82. Hawkins, N. M., "Strength of Concrete-Encased Steel Beams," Proceedings of ASCE Specialty Conference, University of Missouri, 1970.
83. Johnson, R. P., "Composite Beam Design - Ultimate Strength Design of Encased Composite Beams," Consulting Engineer, November 1968.
84. "Specification for the Design, Fabrication and Erection of Structural Steel for Buildings," AISC, 1969.
85. "Commentary on the Specification for the Design, Fabrication and Erection of Structural Steel for Buildings," AISC, 1969.
86. Procter, A. N., "Lateral Torsional Stability of Composite Members," Consulting Engineer, February 1965.
87. Procter, A. N., "Tests on Stability of Concrete-Encased I-Beams," Consulting Engineer, February and March 1967.
88. Varghese, Radhakrishnan and Paramasivan, "Flexural Strength of Encased Beams," Indian Concrete Journal, January 1968.
89. Naghshineh and Bannister, "Behavior of Steel Beams Encased in Lightweight Aggregate Concrete," Civil Engineering (London), October and November 1967.
90. Wong, F. K. C., "Horizontal Shear Resistance of Composite Beams," Structural Engineer (London), August 1963.

91. Ros, M., "Les constructions acier-beton, systeme Alpha," L'Ossature Metallique (Bruxelles), April 1934.
92. Gwylon, I., "Further Developments in Composite Techniques," Journal of the British Constructional Steelwork Association, August 1964.
93. Barsoum, R. S., "The Stiffening Effect of Cladding on Multi-story Buildings," Cornell University M. S. Essay, 1968.
94. Stevens, R. F., "Encased Stanchions," Structural Engineer (London), February 1965.
95. Laredo and Bard, "Etude des poteaux mixtes acier beton et leur application aux gratte-ciel," Inst. Technique de Batiment et des Travaux Publics, Paris, February 1969.
96. "Building Code Requirements for Reinforced Concrete, ACI 318-63," ACI, 1963.
97. BS 449, "The Use of Structural Steel in Buildings," British Standards Institution, 1965.
98. CP 114, "The Structural Use of Reinforced Concrete in Buildings," British Standards Institution, 1957.
99. Jones and Rizk, "Investigation on Behavior of Encased Steel Columns Under Load," Structural Engineer (London), January 1963.
100. Procter, A. N., "Full Size Tests Facilitate Derivation of Reliable Design Methods," Consulting Engineer, August 1967.
101. Bondale, D. S., "Column Theory with Special Reference to Composite Columns," Consulting Engineer, July, August and September 1966.
102. Basu, A. K., "Computation of Failure Loads of Composite Columns," Proceedings, Institution of Civil Engineers, March 1967.
103. Basu and Hill, "More Exact Computation of Failure Loads of Composite Columns," Proceedings, Institution of Civil Engineers, May 1968.
104. Roderick and Rogers, "Load Carrying Capacity of Simple Composite Columns," ASCE Journal of the Structural Division, February 1969.
105. Gardner and Jacobson, "Structural Behavior of Concrete Filled Steel Tubes," ACI Journal, July 1967.
106. Gardner, N. J., "Use of Spiral Welded Steel Tubes in Pipe Columns," ACI Journal, November 1968.
107. Furlong, R. W., "Strength of Steel-Encased Concrete Beam Columns," ASCE Journal of the Structural Division, October 1967.
108. Furlong, R. W., "Design of Steel-Encased Concrete Beam-Columns," ASCE Journal of the Structural Division, January 1968.
109. "Proposed Revisions of ACI 318-63," ACI Journal, February 1970.
110. Neogi, Sen and Chapman, "Concrete-Filled Tubular Steel Columns Under Eccentric Loading," Structural Engineer (London), May 1969.
111. Haaijer, G., "Economy of High Strength Steel Structural Members," ASCE Journal of the Structural Division, December 1961.
112. Report of Subcommittee 1 on Hybrid Beams and Girders, Joint ASCE-AASHTO Committee on Flexural Members, ASCE Journal of the Structural Division, June 1968.
113. Milek, W. A., "Homogeneous and Hybrid Girder Design in the 1969 AISC Specifications," AISC Engineering Journal, January 1970.
114. Schilling, C. G., "Bending Behavior of Composite Hybrid Beams," ASCE Journal of the Structural Division, August 1968.
115. Carskaddan, P. S., "Shear Buckling of Unstiffened Hybrid Beams," ASCE Journal of the Structural Division, August 1968.
116. Lew, Natarajan and Toprac, "Static Tests on Hybrid Plate Girders," Welding Journal, February 1969.
117. Carskaddan, P. S., "Bending of Deep Girders with A514 Steel Flanges," ASCE Journal of the Structural Division, October 1969.
118. "Standard Specifications for Highway Bridges," 9th Edition, American Association of State Highway Officials, 1969.
119. Massonnet, C., "Tendances actuelles dans la conception et le calcul," Construction Metallique, June 1969.

120. "Survey of Current Structural Research," ASCE Manual 51, 1970.
121. "Development and Use of Prestressed Steel Flexural Members," Subcommittee 3 on Prestressed Steel of Joint ASCE-AASHO Committee on Flexural Members, ASCE Journal of the Structural Division, September 1968.
122. Ferjencik and Tochacek, "Predpate Kovove Konstrukcie," Slovenske Vydavatelstvo Technickej Literatiry, Bratislava, 1966.
123. Cholous, J., "La precontrainte dans le renforcement des ponts metalliques de la S.N.C.F.," IABSE Seventh Congress, Preliminary Publication, 1964.
124. Tachibana, Kondo and Ito, "Experimental Study on Composite Beams Prestressed with Wire Cable," IABSE Seventh Congress, Preliminary Publication, 1964.
125. Iljasevitsch, S. A., "Vorgespannte Stahlkonstruktionen und Stahlbrucken," IABSE Seventh Congress, Preliminary Publication, 1964.
126. Li, S., "Control of Prestress in Steel Structures," IABSE Seventh Congress, Preliminary Publication, 1964.
127. "Prestressed Steel Beams Replace Concrete," Welding Design and Fabrication, April 1961.
128. Baes and Lipski, "La Poutre Preflex," Congress International du Beton Precontraint de Gand, September 1951.
129. Beadle, Dally and Riley, "Rigidity and Strength of Composite Plates," ASCE Journal of the Engineering Mechanics Division, December 1964.
130. Casillas, Khachaturian and Siess, "Studies of Reinforced Concrete Beams and Slabs Reinforced with Steel Plates," University of Illinois, Structural Research Series 134, 1967.
131. Johnson, R., "Research on Composite Steel-Concrete Beams, 1960-1968," ASCE Journal of the Structural Division, March 1970.
132. Fauchart and Sfintesco, "The Development and Use of the Robinson Composite Deck in France," IABSE Symposium on Wearing Surfaces for Steel Bridge Decks, 1968.
133. "The Paris-Massena Bridge, A Cable-Stayed Structure," Acier-Stahl-Steel, June 1970.
134. Ekberg and Schuster, "Floor Systems with Composite Form-Reinforced Concrete Slabs," IABSE Eighth Congress, September 1968.
135. "Structural Sandwich Construction," ASTM Standards, Part 16, 1969.
136. "Symposium on Structural Sandwich Constructions," ASTM Special Technical Publication No. 118, 1951.
137. "Symposium on Structural Sandwich Constructions," ASTM Special Technical Publication No. 201, 1956.
138. "Symposium on Durability and Weathering of Structural Sandwich Constructions," ASTM Special Technical Publication No. 270, 1959.
139. Dietz, A. G. H., Editor, "Composite Engineering Laminates," Chapters 2, 3 and 9, MIT Press, 1969.
140. "Structural Design Concepts - Some NASA Contributions," National Aeronautics and Space Administration Technology Utilization Publication SP-5039, 1967.
141. Plantema, F. J., "Sandwich Construction - The Bending and Buckling of Sandwich Beams, Plates and Shells," John Wiley and Sons, 1966.
142. Aleksandrov, Bryukker, et. al., "Raschet Trekhsloynnykh Pamley," Gosudarstevnoye Naucho-Tekhnicheskoye Izdatel'stvo, Oborongiz, Moskva, 1960.
143. Dundrova, Kovarik and Slapak, "Teorie Ohybu Sendvicovykh Desek," Technical University in Prague, Building Research Institute, 1964.
144. Allen, H. G., "Analysis and Design of Structural Sandwich Panels," Pergamon Press, 1969.
145. Hartsock, J. A., "Design of Foam-Filled Structures," Technomic Publishing Co., 1960.
146. Smolenski and Krobosky, "Optimal Multifactor Design Procedure for Sandwich Panels," ASCE Journal of the Structural Division, April 1970.

147. Bishop, W., "Thin Walled Steel Structures - Their Design and Use in Buildings," Symposium at University College of Swansea School of Engineering, Gordon and Breach Science Publishers, pp. 340-355, 1967.
148. Epstein, G., "Adhesive Bonds for Sandwich Constructions," Adhesives Age, August 1963.
149. Becker, W. E., "U. S. Sandwich Panel Manufacturing/Marketing Guide," Technomic Publishing Co., 1968.
150. "Sandwich Panel Design Criteria," Proceedings of Research Correlation Conference Conducted by the Building Research Institute, National Academy of Science - National Research Council, Publication 798, 1960.
151. Platts, R. E., "Structural Sandwich Components in Buildings," National Research Council of Canada, Technical Paper 267, July 1968.
152. Deborde, B., "Prefabricated Curtain-Walling in Stainless Steel," Acier-Stahl-Steel, March 1963.
153. "Load-Bearing Sandwich Panels Form Weather-Tight Skin," Architectural Record, September 1969.
154. Cran, J. A., "Developments in Sandwich Panels," Symposium on Panelized Building Systems, Sir George Williams University, June 1970.
155. McCavour, T. C., "Frameless Industrialized Steel Building Systems," Symposium on Panelized Building Systems, Sir George Williams University, June 1970.
156. Caldwell and Cooke, "Thin-Walled Steel Structures - Their Design and Use in Buildings," Symposium at University College of Swansea School of Engineering, Gordon and Breach Science Publishers, 1967.
157. Silva, J., "Thin-Walled Steel Structures - Their Design and Use in Buildings," Symposium at University College of Swansea School of Engineering, Gordon and Breach Science Publishers, 1967.
158. Thul, H., "Seilverspannte Brücken," Deutscher Stahlbau-Verband, 1966.
159. Thul, H., "Cable-Stayed Bridges in Germany," British Constructional Steelwork Association, Conference on Structural Steelwork, September 1966.
160. Feige, A., "Evolution of German Cable-Stayed Bridges - Overall Survey," AISC Engineering Journal, July 1967.
161. Taylor, P. R., "Cable-Stayed Bridges and Their Potential in Canada," Engineering Journal (Canada), November 1969.
162. Simpson, C. V. J., "Modern Long Span Steel Bridge Construction in Western Europe," Proceedings, Institution of Civil Engineers, 1970.
163. Leonhardt and Zellner, "Cable-Stayed Bridges - Report on Latest Developments," Canadian Structural Engineering Conference, University of Toronto, February 1970.

SUMMARY

The most common structural components which involve interaction of structural steel with other materials or steel of other quality are discussed. Included are composite steel-concrete beams, concrete-encased steel beams, steel-concrete columns, hybrid beams, composite plate components and cable-stayed bridges.

The state-of-the-art is outlined for each element either directly in the paper or by reference to other recent publications. Particular attention is given to principal research completed during the past decade and the practical impact of its results. The paper is documented by a selective bibliography.

RESUME

Il est question dans cet article des éléments de construction les plus courants faisant intervenir l'interaction de l'acier avec d'autres matériaux ou avec des aciers de caractéristiques différentes. Citons par exemple poutres mixtes béton-acier, poutres en acier encastées dans du béton, colonnes de béton armé, poutres hybrides, éléments de dalles, ponts à cables.

L'état actuel du développement est exposé soit directement soit en renvoyant le lecteur à d'autres publications récentes. On prête une attention particulière aux recherches des dix dernières années ainsi qu'à leurs conséquences pratiques. L'article est documenté par une bibliographie choisie.

ZUSAMMENFASSUNG

Die gebräuchlichsten Konstruktionselemente, die durch die Zusammenwirkung mit Baumaterialien oder Stahl anderer Baugüte entstehen, werden erläutert. Erwähnt werden Verbundträger aus Beton und Stahl, von Beton umhüllte Stahlträger, von Beton umhüllte oder mit Beton gefüllte Stahlstützen, Hybrid-Träger, Plattenelemente in Verbundbauweise und seilverspannte Brückenträger.

Von jedem Element wird der neueste Stand der Entwicklung entweder direkt umrissen oder auf die neuesten Publikationen verwiesen, wobei der Grundlagenforschung des letzten Jahrzehnts mit dem Einfluss ihrer Resultate auf die Praxis besondere Beachtung geschenkt wird. Eine ausgewählte Bibliographie ist beigefügt.

Leere Seite
Blank page
Page vide

IIb

Interaction of different Structural Elements

Interaction entre différents éléments

Wechselwirkung zwischen verschiedenen Konstruktionsgliedern

LEO FINZI

Professor at the Polytechnic
University of Milan, Italy
F.A.S.C.E.

1. Introduction

The designer of a structure, especially when this is made up of one-dimensional elements, is often induced to study its behaviour by means of the analysis of the state of stress and strain of plane elements (continuous beams, frames, trusses), considering them as autonomous in spite of the fact that these normally act in parallel with similar structural elements side by side with them.

So for example the steel skeleton of a multi-story building of the "rigid frame" type (fig. 1 a) is really made up of a space frame, but in fact the calculation of the internal actions N , M and T is carried out by means of an autonomous study of continuous beams, of transversal and of longitudinal plane frames. Only when testing the stability of the single members (e. g. a column) is the problem put in three-dimensional terms.

The secondary structures between the main beams (slabs and beams) are thus normally considered as elements carried by the main structures and may be called in as incidental collaborators only to improve the performance of the transversal section of the beams (e. g. composite beams).

This kind of approach can, in reality, be only fully justified, for structures that have complete geometrical and loading symmetry but, if these conditions are not present, interaction phenomena will show up between the structures functioning in parallel. This will clearly work in favour of the safety of those structures which are helped out by adjacent structures, but to the disadvantage of these latter.

The two dimensional approach, then, practically ignores the respect for compatibility in three-dimensional space in which all structures stand.

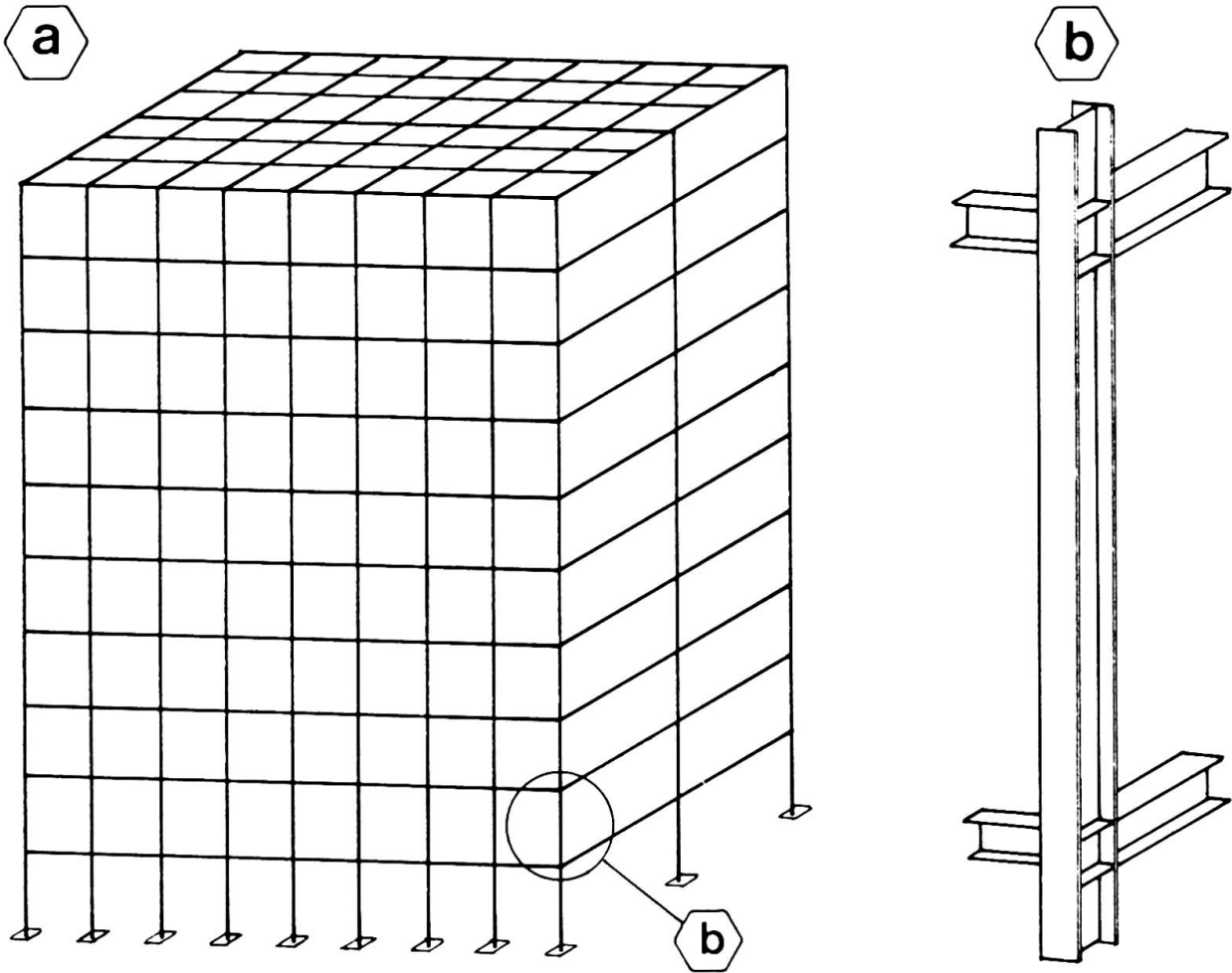

Fig. 1

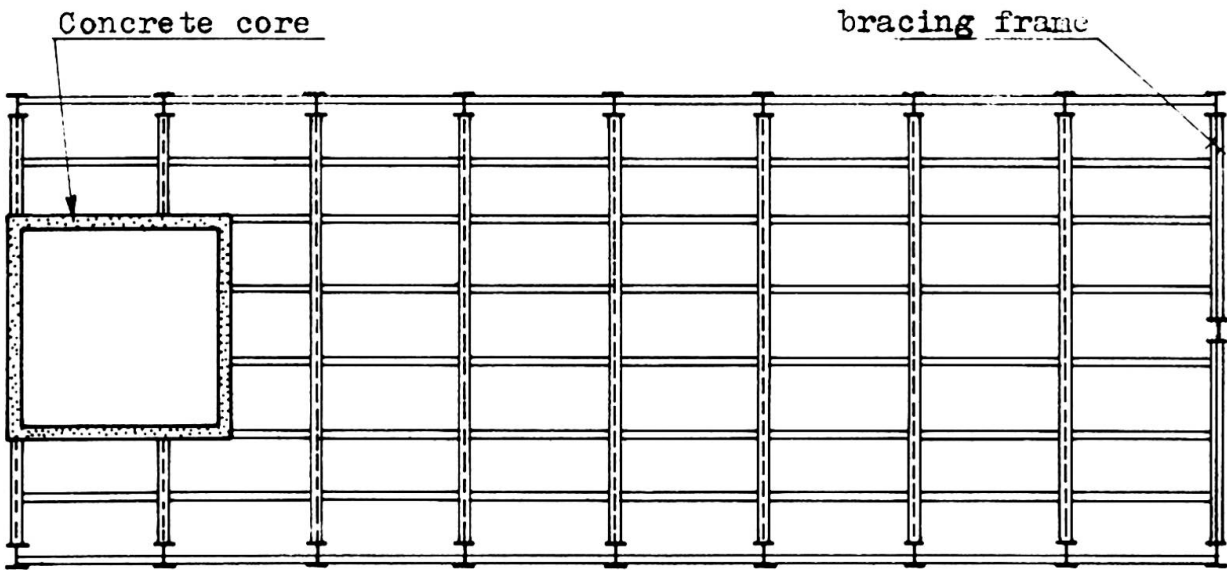

Fig. 2

The interactional behaviour that this paper is about stems from this omission.

A great deal of work has been done on the qualitative aspect of this subject. Its quantitative aspect, however, as received far less attention.

In effect, the designer is much more likely to turn to a single plane approach, because of the smaller number of unknowns present in calculation, and because it is easy to represent and to read. Also, in order to attain this result, he will accept simplifying hypotheses which, though they are often reasonable, sometimes may not be so.

There are cases in which neglecting this interaction between structural elements certainly leads to giving the structure as a whole larger dimensions than strictly necessary. In this respect a typical case is that of beam and slab bridges made up of a slab and a series of longitudinal beams side by side. The presence of loads which are mobile and flanked by others that are remarkably different (civil and military loads) leads, if this interaction is neglected, to giving such dimensions to all of the beams as would only be needed for those committed to the most heavily loaded trains.

Correctly evaluating and taking into account the effects of interaction is therefore fundamental for rational and economic designing.

A great deal of theoretical and experimental work has been done on this problem, which is still receiving considerable attention.

This can also be referred to large panel prefabricated buildings, where taking into account the stresses induced by horizontal forces (wind and earthquakes) in all the walls and correctly sharing out the loads among them, rather than entrusting this to apposite bracing walls, leads to a much wider range of architectural and distributive solutions. A considerable amount of research is being carried out in this particular field.

When working with one-dimensional, typically steel, elements, architectural and distributive requirements govern the designers choice of the number and position of the bracing structures. It would seem then that the problem of interaction would be of minor importance in this case.

Nevertheless these general requirements mentioned above often impose the insertion of shear trusses in eccentric positions unfavourable to an equitable distribution of the horizontal forces. They also discourage the mutual collaboration of structures in reinforced concrete, such as stair cases and elevator wells, with steel trusses or frames (fig. 2). Less work has been done on this problem than might be thought, with the result that bracing systems are often overdone.

However, there are cases in which the effects of interaction do not greatly improve the static commitment of those structures favoured by the process of interaction itself, but noticeably overburden the elements called in to help them.

This happens, for example, in large span factory roofs supported by reinforced concrete columns. Neglecting the friction forces of the supports, assumed to be frictionless, has sometimes led to splitting in the columns. This is because they impede the thermal deformations of the roof to a greater extent than the designer had allowed for.

Or again, everyone knows how frequent is cracking parallel to the reinforcement in the slabs of concrete and ceramic blocks (widely used as secondary elements in mediterranean countries) adjacent to the edge beams, i. e. in those areas where the beams tend to make the slab act as a plate, a function for which it was not designed.

These examples confirm that it is a question of sins of commission against the compatibility of displacements and strains, the more serious in their consequences as the material involved is more brittle, and thus important in composite structures of steel and concrete.

Nevertheless, there can also be serious drawbacks for metal structures at least in the presence of geometrical second order effects or corresponding to the presence of plastic flow. Thus for example in a tower, such as the one shown in plan form in fig. 2 the resistance to wind action can be largely entrusted to the core walls containing the staircase and utilities located at one side.

This core wall will furthermore be heavily subjected to torsional stress and, in the more distant transversal frames, will give rise to a $P-\Delta$ effect of considerable importance for the purposes of the limit design of the structure as a whole.

In this category there are also the instability phenomena (lateral buckling) which arise in thin partitions following elastic or thermal deformations in the loadbearing structure when suitable steps have not been taken to prevent it (figs. 3 a and 3 b).

Having shown, by means of examples, the essence of the phenomena in question, it seems suitable to refer to the following categories of problems.

a) Interaction in multi-storey buildings between beam-column frames, shear trusses, and concrete walls, in the resistance to lateral forces.

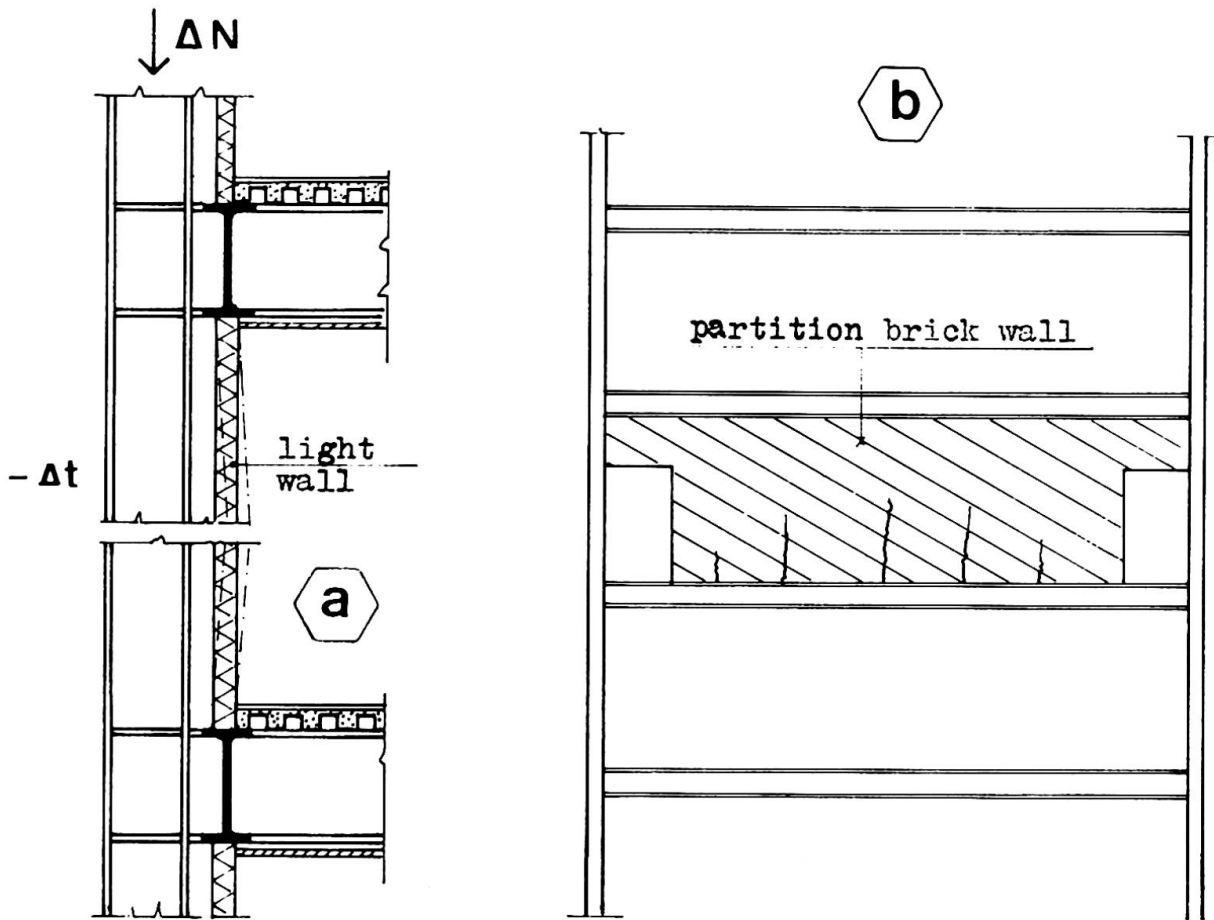

Fig. 3

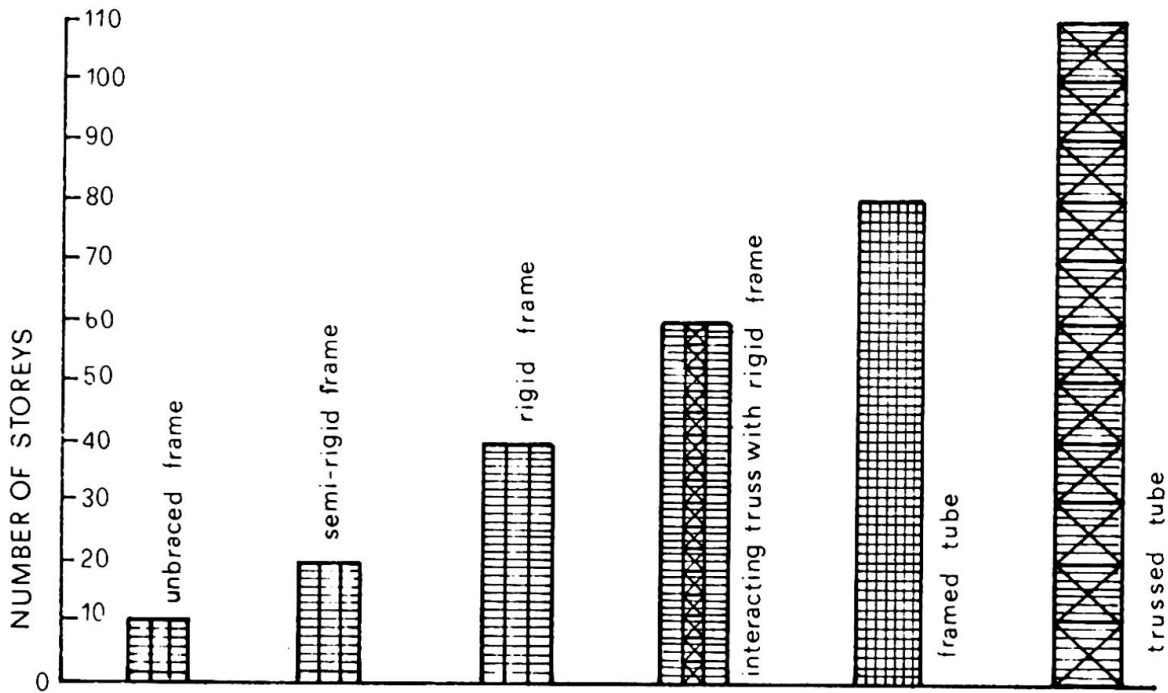

Fig. 4

- b) Interaction between the beams of bridge decks when faced with moving loads.
- c) Interaction between beams and slabs or roofings and between columns and wall decking when faced with instability phenomena.
- d) Interaction between the structure and the soil.
- e) Interaction between loadbearing structures and nonloadbearing elements.

2. Bracing systems for high-rise buildings

In tall buildings the premium for height is very much tied to the type of wind bracing used, and the best solutions vary with the height. The question has been thoroughly treated by F. R. Khan and others [1] [2] [3] [4] [5] [6] [7] [8].

In particular the suitability of various types of vertical wind bracing (fig. 4) has been quite well gone into, while the discussion is still open on the limits within which apposite horizontal floor bracing (fig. 5) can be left out for transferring the forces acting on each floor to the wind bracing.

American examples, the World Trade Center in New York and the U. S. S. Headquarters building in Pittsburgh, seem to show that, for massive constructions the problem does not exist. However, it should not be forgotten that in buildings that are so compact and rich in wind bracing, the slab floor is much less called upon to participate than in a European type of building with an extended rectangular plan and without rigid joints.

Another problem that is still open involves thermal effects in the structures of tall buildings. This becomes particularly important when one part of the structure is exposed and another is not [9].

In this respect for example it is to be feared that the advantage to the wind bracing system deriving from the use of rigid cap trusses (fig. 6) will be greatly reduced.

An interesting but infrequent case is that of buildings with a central concrete or steel core and cap horizontal trusses from which the lower floors are suspended by tendons. If a "rigid frame" is adopted interaction effect may be of great importance due to the contrary behaviour of the external vertical structures whose tensile axial load increases from the bottom to the top of the building and the interior ones which are increasingly compressed from the roof to the basement.

A similar lateral force distribution problem arises in large factory buildings, especially when containing heavy cranes. In this event a careful evaluation of the effects of interaction between the columns, both transversally

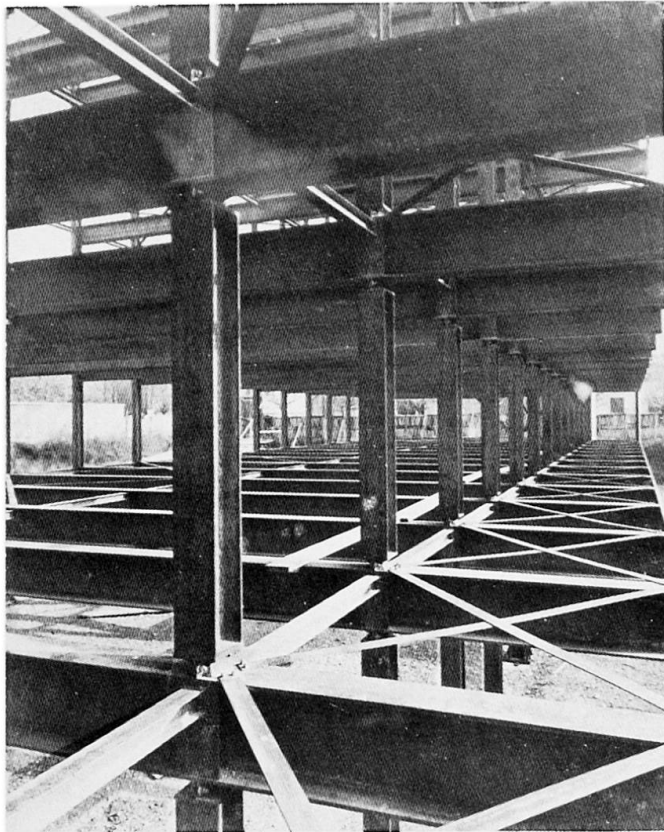

Fig. 5

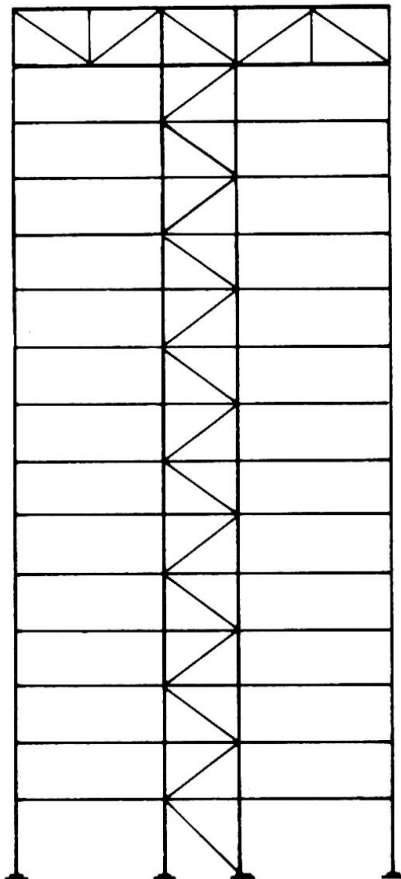

Fig. 6

and longitudinally, can be very rewarding [10]. Such an interaction can be obtained by using either opportune roof bracings or the horizontal bracings of the crane runways. Minor details may be of great importance [11].

It can be said then, that the greatest advantages are obtained when, as in the above case, there are moving loads or loads concentrated in limited areas.

A case of this type arises for great aircraft hangars, where wind forces act in widely varied ways depending on wind direction and whether or not the doors are open. In this sort of case diffused wind bracing (fig. 7) produces the best interaction effects.

3. Bridge decks

For bridge decks, whether of the "beam and slab" (fig. 8 a) or the "box girder" (fig. 8 b) type, the problem of the distribution of wheel loads, or the effects of interaction between side by side longitudinal beams, has been studied very thoroughly, both experimentally and theoretically in the last 25 years. The recent Report 83 of the U. S. A. Highway Research Board [12] quotes almost 300 papers on the subject. These studies have been carried out with differing approaches: orthotropic plate analysis, articulated plate theory, equivalent grid system, harmonic analysis and numerical moment distribution, prismatic folded-plate theory, beam on elastic foundation analogy, ecc. . . .

The present state of knowledge seems satisfactory for small and medium span (40 m.max) supported floor systems of highway bridges. But this is not true for the large spans and multicellular cross sections used for very wide bridges. There are some problems of interaction still open, too, for skew bridges [13] and curved girder bridges [14] [15] which are far from being infrequent. Finally, behaviour in the case of continuity and for portal frame bridges is also being studied as the secondary moments in the bridge due to its flexibility and the eccentricity of the loading are not equally reduced [16] [17]. It is felt that the assumption that the effective length of the bridge for load distribution effects is the distance between points of contraflexure should be clarified through future additional theoretical work.

Particularly difficult, for the effect of interaction phenomena, are the large span orthotropic steel plate deck bridges. Here in fact, the deck plate and the longitudinal ribs are subject to a double interaction effect i. e. the deck as a part of the main carrying members (system I) with either the deck as the bridge floor (system II) or the deck plate acting between longitudinal ribs (system III).

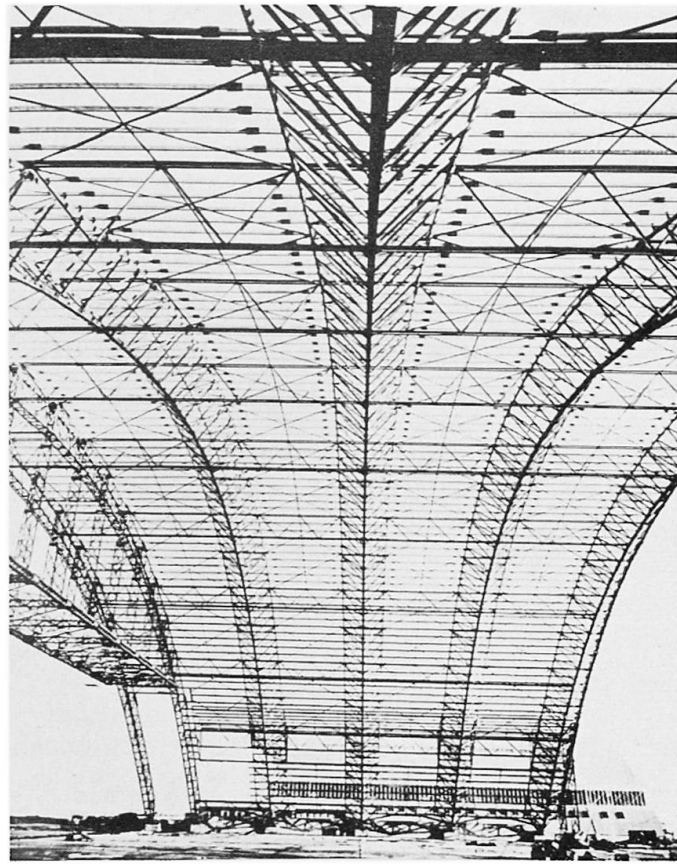

fig. 7

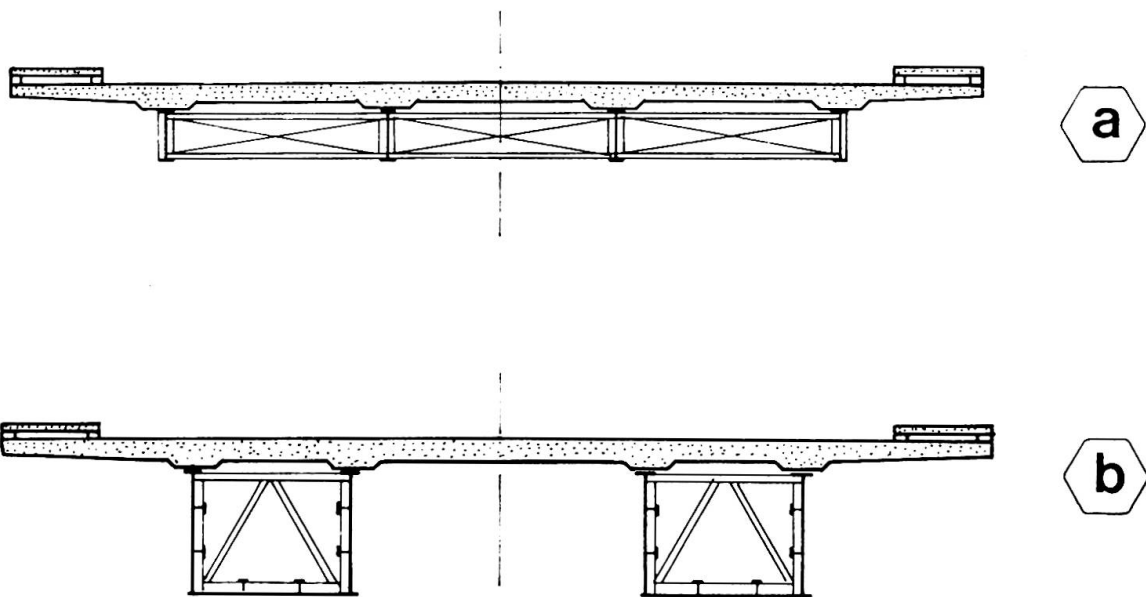

fig. 8

These three systems when loaded differ substantially because both the second and the third draw great static resources from geometrical second order effects and plastic adaptation.

That is, highly concentrated loads are supported [18] [19] [20] [21] by means of membrane behaviour and local yielding of steel which improve in an extraordinary way the static resources of the structure, so much so that, based on experimental results [22], the largest bridges of this type [23] [24] have been designed by reducing to a half or even less the stresses calculated in the first order approach for system II and those of system III have even been left out completely in calculating the maximum total stresses.

It seems that in this sector, so important for the development of steel bridges, a great deal of theoretical and experimental research is to be hoped for, and the problems bound up with fatigue and shake down phenomena should not be neglected.

4. Roof decking and wall cladding bracing effect

It is by now quite frequent for the roof deckings of light gage corrugated sheets to be fastened to beams of the roof by plug welds, shot nails or rivets with the intention of giving the roof decking the function of ensuring the lateral stability of the beams as well as the job of sharing out the horizontal forces due to wind or earthquakes to the vertical structures. This leads to the elimination of the roof bracings (fig. 9) which, usually, in order to avoid interference with the purlins and girders of the roof, call for construction details (plates and ribs) that are expensive and out of proportion to the dimension of the bracing members themselves.

In this field interesting studies and experiments have been started in the U. S. A. at Cornell University [25] to establish the limits within which a light-gage steel roof or floor decking can restrain lateral buckling of truss chords, beams and purlins. It seems that the interaction of a shear-resistant metal diaphragm made up of corrugated sheets can produce a several-fold increase (6 to 8 times) in carrying capacity and the yield moment of beams appears to be readily obtainable.

Equally brilliant results have been obtained at Cornell [26] [27] [28] [29] by studying the behaviour of columns directly connected by corrugated sheets or by horizontal purlins and corrugated sheets.

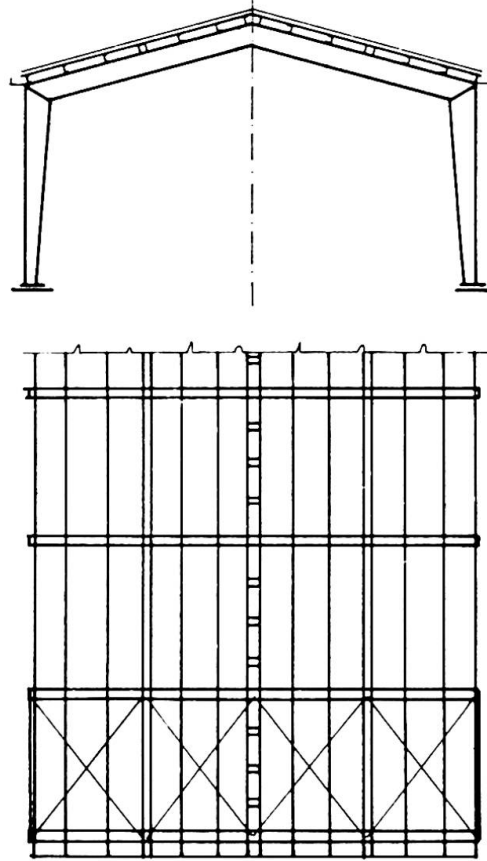

fig. 9



fig. 10

The weak axis buckling of columns is prevented up to the elastic limit load. Above the elastic limit load the influence of diaphragm bracing is less pronounced and less predictable. If diaphragm bracing are connected to girts, which in turn are connected to the columns with a twist-restraining column girt connection, the critical load may be increased to that of a column having an effective length equal to the girt spacing.

The results from the above research have been very encouraging, and it is to be hoped that the work will be pursued until arriving at sufficiently simple calculating rules. Nevertheless, it seems that, while in the case of the beams the presence and therefore the efficiency of shear-resistant diaphragms can be guaranteed in time, the same cannot be said for the columns where the need to open doors or windows can substantially modify the original situation.

But the interaction between cladding and main structure to ensure the overall functioning of the wind bracing of the structure does not yet seem to have received systematic treatment, even if there are structures with even very large spans (fig. 10) which rely on this. It is certainly to be hoped that the question will be looked at theoretically and experimentally in the future.

5. Soil structure interaction

Interaction effects similar to those mentioned above between main and secondary structures, or between structures functioning in parallel, also arise between the structure and its foundation soil.

They are effects that are known and studied only with reference to particular cases [30] [31] [32] [33], but important for all that. They regard two materials that are widely differing in their behaviour (steel or concrete and soil) especially when faced with creep and relaxation phenomena.

Consider for example a steel skeleton frame construction with hinged connections that has columns founded on independent footings and so dimensioned as to commit the soil homogeneously and so that the bulbs of pressure do not significantly interfere with each other. The fact that one column is submitted to a maximum live design load while those adjacent to it are subjected only to the permanent loads will not substantially alter the state of stress in the steel structure above the ground, and thus there will be no appreciable interaction phenomena.

But now consider a construction with extremely rigid loadbearing structures, such as a silo for minerals (fig. 11).

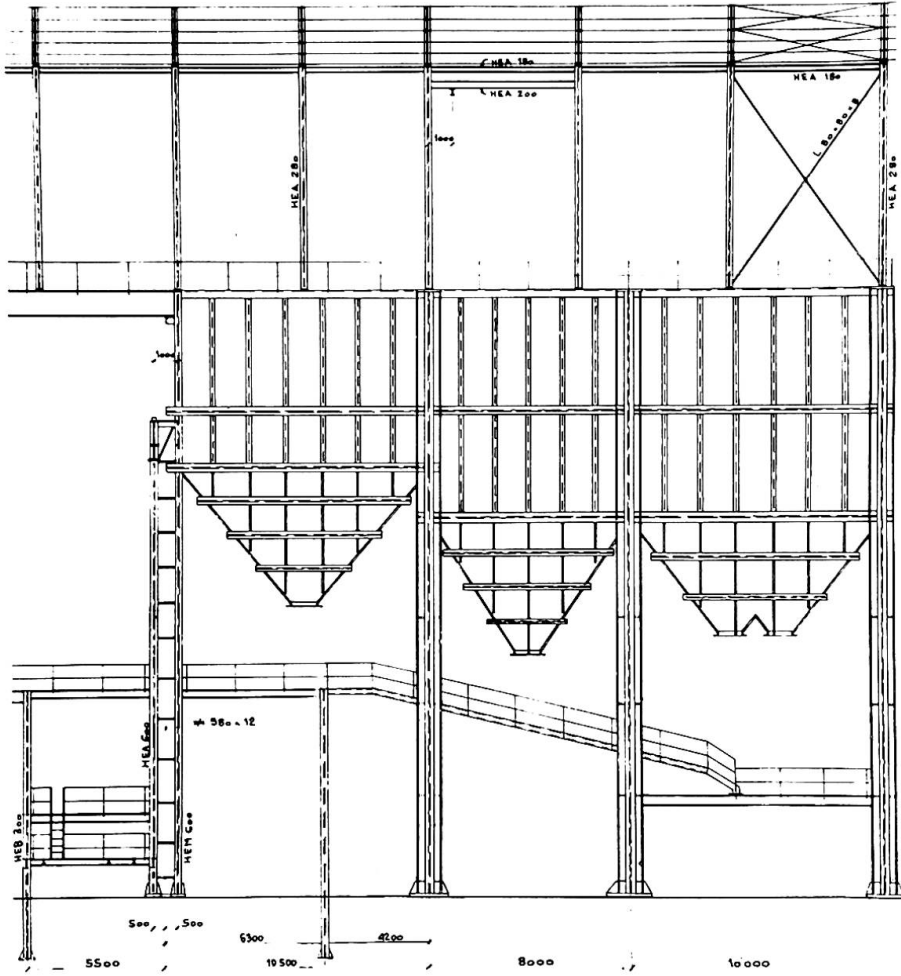

fig. 11

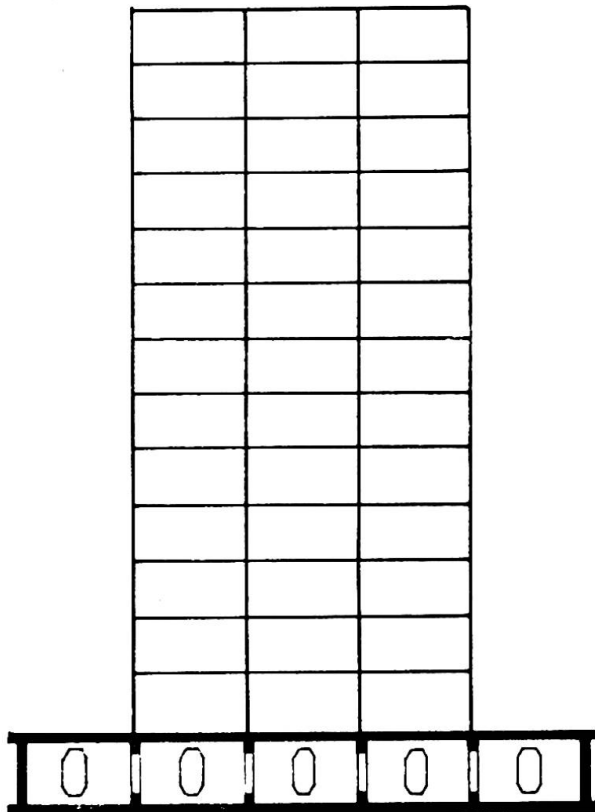

fig. 12

Here if isolated plinth foundations are used, it is practically impossible on the one hand to prevent the pressure bulbs interfering with each other, while on the other hand the rigid walls above the ground have a high power of distribution between the pillars.

It follows that live loads present in a limited central zone tend to transfer to the adjacent zones until reaching complete and uniform distribution between the columns and on the ground. The latter, however is more deformable in the central area, where the pressure bulbs interact, than at the perimeter. It can then be said that the perimeter pillars tend to be the most loaded.

Return now to the case of the hinged steel skeleton, but this time with a box-plate foundation (fig. 12) of great stiffness. Here the distribution of loads on the steel structure will have but little influence on the soil response and in this regard only the resultant in position and size will count. In these conditions the presence of live loads only in the central zone will lead to high bending moment and shear values in the box-plate. The shear will be particularly dangerous because, as is well known, in this kind of foundation the walls are impaired by the presence of doors or windows which give rise to important Vierendel effects.

These interaction phenomena are particularly worrying when the ground water level varies in time.

For example, over the last 20 years the level in Milan has fallen by about 25 m. and the same thing happens in cities where the water is drawn from the sub-soil.

The consequent ground settlement which is without linear characteristics, especially if the stresses in the zone are not uniform, profoundly modifies the state of stress of structures on it, because it leads to relative vertical displacements in the order of centimeters.

The cathedral of Milan is in this situation, and costly repair work is going on to strengthen the structures concerned (main arches and main columns) and to arrest the movement of the relative foundations.

Finally it should be remembered that during the construction of a building the stiffness ratios between structure and soil vary continuously in the sense that creep phenomena in time diminish soil rigidity, but the rigidity of the building increases as the structures are erected and connected with wind braces, so that even this aspect of the problem should not be neglected in designing.

Furthermore the behaviour of the foundation soil is in general substantially modified when new buildings are constructed beside those already there, as happens for example when a warehouse is extended.

Even if this is a field at the border between structural engineering and soil mechanics, it seems to deserve more attention from engineers and research workers than it has so far received.

6. Non structural elements

The interaction between those elements which are structural and others which are not, that is between load bearing structures and finishings such as floors, partition and curtain walls, ceilings, is generally undesirable in that it can lead to disconnections, cracks and ruptures in the non-loadbearing elements. For these reasons curtain walls, for example, are designed as elements to be hung from the perimeter of the loadbearing structure with suitable expansion joints to allow free expansion. Similarly the partition walls are clamped to the slabs or the beams of the upper edge by highly deformable elements (springs and padding) which reduce to reasonable limits the loads absorbed by the partition wall in relation to its connection with the upper slab without making it break away from the latter when the lower slab is more heavily loaded. This expedient avoids the inconveniences mentioned in the introduction (figs. 3 a and 3 b).

In the same way the interaction between the slab and the flooring may give rise to cracks in the latter corresponding to the areas of negative moment. This happens when floating floors are not used, nor suitable expansion joints in the floor itself.

Nevertheless there are cases in which the interaction between masonry walls and the steel structures which support them can be advantageous. This is the case of brick walls stiffened by I beams and channels. Fig. 13 shows how a 12 cm thick masonry wall is supported on a free span of about 14 m by CNP 140 horizontal channels. Vertical tendons connect the upper and lower channel so as to suspend the dead load of the brick wall to an incorporated arch of which the lower channel is the tie. Actually this is quite a common way to obtain economic and well insulated exterior claddings but the study of such behaviour should be improved.

The same can be said about claddings obtained with exterior corrugated sheets connected to horizontal steel beams [34]. In this case obviously the decking acts only as a shear-resisting member while bending moment must be supported by the steel girts.

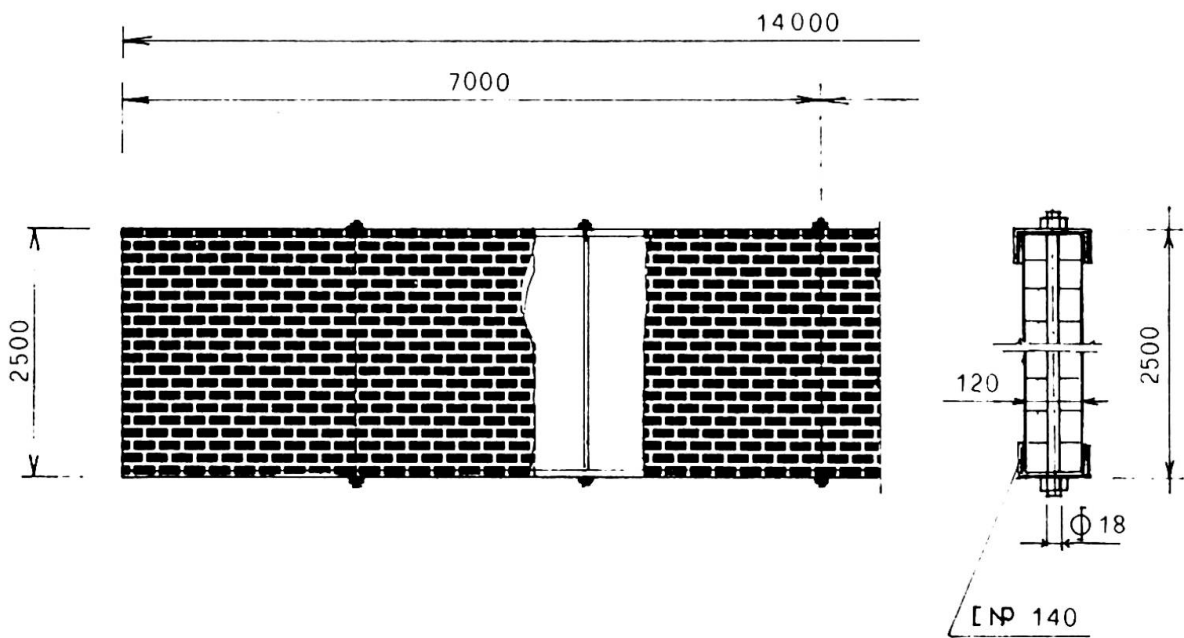
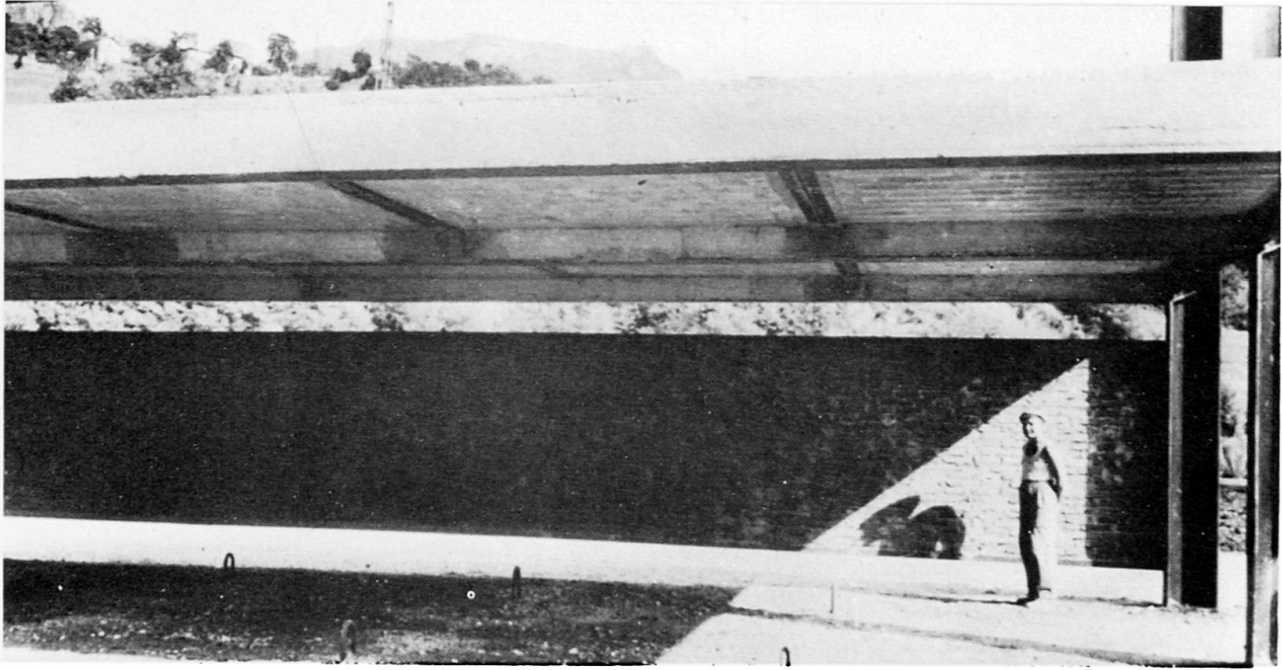

Fig. 13

7. Conclusions

This paper has been an attempt to set out certain favourable and unfavourable aspects of interaction phenomena which occur between parts of the loadbearing structure, between this and the soil or between the main loadbearing structure and secondary structural or non-structural elements.

It seems that the most studied aspects of this problem, as is only human, are those which, through interaction phenomena, lead to favourable results and so to more economical and rational construction. But those interaction effects that lead to the overstressing of structural and non-structural parts have been less studied.

Generally speaking more research has been done on housing and office blocks and on bridges. Much less studied are the problems that occur in factories where, however, it seems that a three-dimensional vision even of the present structural approaches might lead to considerable gains at least where the live loads are not uniformly distributed.

In general, then, it seems that considerable benefit might still be derived from a correct evaluation of the effects of interaction in the presence of dynamic actions (wind and earthquakes) not only in the evaluation of the deflections but also of the general collapse load.

The unfavourable effects of interaction due to temperature have also been too little studied.

These effects are growing in importance as the buildings rise in height and enlarge more and more, with part of the main structure free in the air.

Interesting work has been done, or is in progress, on the effects of interaction between decks and beams, and claddings and columns.

In many cases lateral stability of the beams can be ensured simply by suitably fixing the decking to them, and it seems probable that this will lead to safe design in this field. It is certainly to be hoped that this research will be extended.

The importance of preventing the weak axis buckling of columns through the bracing effect of cladding and purlins seems to be interesting only for smaller factories and one-storey buildings.

The need to ensure that the cladding is not removed makes it, in fact, too great a drawback for the user.

The interaction between soil and structure should receive more attention from the structural engineer, especially today when industrialisation has led to the construction of big industrial plants in zones, such as river mouths, where the ground may in time prove to be particularly yielding.

Interactions between loadbearing structure and finishings are generally undesirable. The designer should, with certain exceptions, try to avoid them or contain their effects, but to be able to do so more knowledge is required of the static response of non static materials.

8. Aknowledgments

In concluding this report the author wishes to thank his colleagues H. Beer, S. J. Errera, F. R. Khan, J. R. Novak, W. W. Sanders, M. G. Salvadori, I. M. Viest, who kindly informed him of the work they had in progress or of which they had notice and gave suggestions on arguments of interest in the field. He is also grateful to the American Institute of Steel Construction and to the European Convention of Constructional Steelwork Associations for the opportunity he had to get fresh information in the field at the 22 nd AISC National Engineering Conference (Pittsburgh, May 1970) and at the C. C. S. A. General Assembly (Düsseldorf, June 1970).

9. References

- [1] F. R. KHAN and J. A. SBAROUNIS - Interaction of shear walls and frames - Journ. ASCE, June 1964
- [2] F. R. KHAN, S. H. IYVENGAR and J. P. COLACO - Analysis and design of the 100-storey John Hancock Centre in Chicago (U. S. A.) - Acier Stahl Steel, June 1968
- [3] F. R. KHAN - Recent structural systems in steel for high-rise buildings - BCSA Conf. on steel in Architecture - London, Nov. 1969
- [4] F. R. KHAN - New systems for steel framed building - 22 nd A I S C Nat. Eng. Conf. - Pittsburgh, April 1970
- [5] F. DE MIRANDA e A. G. BOLOCAN - In sintesi i moderni criteri di progettazione delle strutture in acciaio negli edifici multipiano - Costruzioni Metalliche - N. 3 - 1969
- [6] C. MASSONET - Les perspectives de la construction métallique - Annales des travaux publics de Belgique - N. 3 - 1968/69
- [7] A. RUTENBERG - Multistory frames and the interaction of rigid elements under horizontal loads - M. Sc. Thesis, Technion - Israel Institute of Technology - Haifa 1966

- [8] A. BEN - ARROYO - Preliminary wind analysis of multistorey bents - Engineering Journal A. I. S. C. - N. 1 - 1970
- [9] E. R. LAUGHLIN and H. H. WEST - Temperature effects on high-rise buildings AISC Nat. Eng. Conf. - Pittsburgh, April 1970
- [10] I. MUNTEARM - Sulla ripartizione degli sforzi attraverso le controventature della struttura metallica di un capannone industriale - Acier Stahl Steel - N. 5, 1970
- [11] N. BALUT - Contributie la studiul grinzilor de rulare metalice - Doctor thesis Institutul Politehnic Timisoara - Roumanie - 1970
- [12] NATIONAL COOPERATIVE HIGHWAY RESEARCH PROGRAM REPORT 83 - Distribution of wheel loads on highway bridges - Highway Research Board - 1970
- [13] F. LEONHARDT - Neue tendenzen in Berechnung und Konstruktion von Weitespannten Brücken und Viadukten - 8th A. I. P. C. Congress Prel. Pub. , 1967
- [14] G. CERADINI e C. GAVARINI - Teoria dei ponti in curva a travi multiple - Costruzioni Metalliche, N.ⁱ 2, 3, 4, e 6, 1965
- [15] C. CULVER, D. BROGAN, D. BEDUAR - Analysis of curved girder bridges - Engineering Journal A, I. S. C. , N. 1, 1970
- [16] R. E. ROWE - Concrete bridge design - Wiley 1962
- [17] A. C. SCORDELIS - Analysis of continuous box girder bridges - Struct. and Mat. Res. Rep. SESM - 67-25, Un. of Cal. 1967
- [18] M. CAPURSO - Comportamento elastoplastico delle piastre sottili metalliche nel campo dei grandi spostamenti - Costruzioni Metalliche, N. 1, 1968
- [19] M. CAPURSO e R. RAMASCO - Il calcolo elastoplastico delle piastre metalliche nel campo dei grandi spostamenti attraverso le differenze finite - Costruzioni Metalliche N. 3, 1968
- [20] C. MASSONET - General Theory of elasto-plastic membrane-plates - Engineering plasticity - Cambridge Un. Press, 1968
- [21] M. CAPURSO e R. RAMASCO - Sul collasso elastoplastico delle piastre metalliche compresse al perimetro - Costruzioni Metalliche N. 2, 1969
- [22] K. KLÖPPEL - Über zulässige spannungen im Stahlbau - Stahlbau Tagung Baden-Baden, 1954 - Stahlbau Verlag, Köln 1958

- [23] W. PELIKAN and M. ESSLINGER - Die Stahlfarbelm, berechnung und konstruktion - M. A. M. Forschungsheft N. 7 - 1957
- [24] H. BEER - Die Europabrücke über dem Silltal in Tirol - Der Bauingenieur, Vol. 36, 1961
- [25] G. PINCUS, G. P. FISHER - Behavior of diaphragm-braced columns and beams - Proc. A. S. C. E. , Vol. 92 - April 1966
- [26] T. V. S. R. APPARAO - Tests on light-gage steel diaphragms - Rep. n. 328, Dep. of Str. Eng. Cornell Un. - Dec. 1966
- [27] S. J. ERRERA, G. PINCUS, G. P. FISHER - Columns and beams braced by diaphragms - Proc. A. S. C. E. - Vol. 93, Feb. 1967
- [28] L. D. LUTTRELL - Strength and behavior of light-gage steel diaphragms - Cornell Eng. Res. Bull. , 67-1 - 1967
- [29] T. V. S. R. APPARAO, S. J. ERRERA, G. P. FISHER - Column braced by girts and diaphragms - Proc. A. S. C. E. - Vol. 95, May 1969
- [30] E. SCHULTZE - Beispiele für Setzungsbeobachtungen in bindigen und nicht-bindigen Böden - Proc. of the European Conf. on Soil Mech. and Found. Eng. - Wiesbaden 1963
- [31] H. SOMMER - A method for the calculation of settlements, contact pressures and bending moments in a foundation including the influence of the flexural rigidity of the superstructure - Proc. 6th Int. Conf. on Soil Mech. and Found. Eng. - Montreal 1965
- [32] J. FELD - The factor of safety in soil and rocks mechanics - Proc. 6th Int. Conf. on soil mech. and found. Eng. - Montreal 1965
- [33] S. CHAMECKI - Calcul des tassements progressifs des fondations, en tenant compte de l'interaction des structures et du sol - Annales de l'Institute technique du bâtiment et des travaux publics -N. 261, 1969
- [34] C. MASSONET - Poutres de grandes dimensions a ame mince - 8th A. I. P. C. Congress Prel. Pub. 1967

Summary

The report deals with the interaction of different structural elements and assemblies so as to avoid on the one hand overdimensioning and on the other hand overstressing of structural elements. The interaction between frames, bracings, walls, floor slabs, and roofing in buildings, halls and sheds is considered as well as between main girders, bracings and floor slab decks in bridges, and also between the main structure and the soil. Parasitic effects are finally discussed concerning secondary structural or not structural elements.

Résumé

Ce rapport concerne l'étude de l'interaction entre éléments et ensembles structuraux. Cela vise à éviter d'une part le surdimensionnement et d'autre part les tensions excessives dans le calcul des structures. On considère l'interaction entre les cadres, les contreventements, les parois, les dalles et les toitures des bâtiments; de même pour les ponts, entre les poutres principales, les contreventements, les entretoisements, et le tablier. On discute aussi de l'interaction particulière qui se produit entre la structure et le sol. On considère finalement l'interaction entre les éléments soutenus par la structure et la structure elle-même.

Zusammenfassung

Dieser Bericht betrifft die Wechselwirkung zwischen Bauteilen und Bauten, mit dem Zweck, einen rationalen Entwurf, ohne Ueberdimensionierung einerseits oder Ueberbelastung andererseits zu erlauben. Die Wechselwirkungen zwischen Stockwerkrahmen, Windverbänden, Wänden, Decken und Dächern in Gebäuden, Hallen und Shedkonstruktionen, zwischen Hauptträgern, Windverbänden und Decken von Brücken, und auch zwischen Hauptkonstruktionen und Baugrund, werden betrachtet.

Die Nebenwirkungen auf sekundäre Bauteile und nicht zum Bauwerk gehörenden Elementen werden ebenfalls diskutiert.

Leere Seite
Blank page
Page vide