

# Theme IIb: Interaction of different structural elements and assemblies

Objektyp: **Group**

Zeitschrift: **IABSE congress report = Rapport du congrès AIPC = IVBH  
Kongressbericht**

Band (Jahr): **9 (1972)**

PDF erstellt am: **21.07.2024**

## **Nutzungsbedingungen**

Die ETH-Bibliothek ist Anbieterin der digitalisierten Zeitschriften. Sie besitzt keine Urheberrechte an den Inhalten der Zeitschriften. Die Rechte liegen in der Regel bei den Herausgebern.

Die auf der Plattform e-periodica veröffentlichten Dokumente stehen für nicht-kommerzielle Zwecke in Lehre und Forschung sowie für die private Nutzung frei zur Verfügung. Einzelne Dateien oder Ausdrucke aus diesem Angebot können zusammen mit diesen Nutzungsbedingungen und den korrekten Herkunftsbezeichnungen weitergegeben werden.

Das Veröffentlichen von Bildern in Print- und Online-Publikationen ist nur mit vorheriger Genehmigung der Rechteinhaber erlaubt. Die systematische Speicherung von Teilen des elektronischen Angebots auf anderen Servern bedarf ebenfalls des schriftlichen Einverständnisses der Rechteinhaber.

## **Haftungsausschluss**

Alle Angaben erfolgen ohne Gewähr für Vollständigkeit oder Richtigkeit. Es wird keine Haftung übernommen für Schäden durch die Verwendung von Informationen aus diesem Online-Angebot oder durch das Fehlen von Informationen. Dies gilt auch für Inhalte Dritter, die über dieses Angebot zugänglich sind.

## IIb

### Interaction of different Structural Elements

Interaction entre différents éléments

Wechselwirkung zwischen verschiedenen Konstruktionsgliedern

LEO FINZI

Professor at the Polytechnic  
University of Milan, Italy  
F.A.S.C.E.

#### 1. Introduction

The designer of a structure, especially when this is made up of one-dimensional elements, is often induced to study its behaviour by means of the analysis of the state of stress and strain of plane elements (continuous beams, frames, trusses), considering them as autonomous in spite of the fact that these normally act in parallel with similar structural elements side by side with them.

So for example the steel skeleton of a multi-story building of the "rigid frame" type (fig. 1 a) is really made up of a space frame, but in fact the calculation of the internal actions  $N$ ,  $M$  and  $T$  is carried out by means of an autonomous study of continuous beams, of transversal and of longitudinal plane frames. Only when testing the stability of the single members (e. g. a column) is the problem put in three-dimensional terms.

The secondary structures between the main beams (slabs and beams) are thus normally considered as elements carried by the main structures and may be called in as incidental collaborators only to improve the performance of the transversal section of the beams (e. g. composite beams).

This kind of approach can, in reality, be only fully justified, for structures that have complete geometrical and loading symmetry but, if these conditions are not present, interaction phenomena will show up between the structures functioning in parallel. This will clearly work in favour of the safety of those structures which are helped out by adjacent structures, but to the disadvantage of these latter.

The two dimensional approach, then, practically ignores the respect for compatibility in three-dimensional space in which all structures stand.

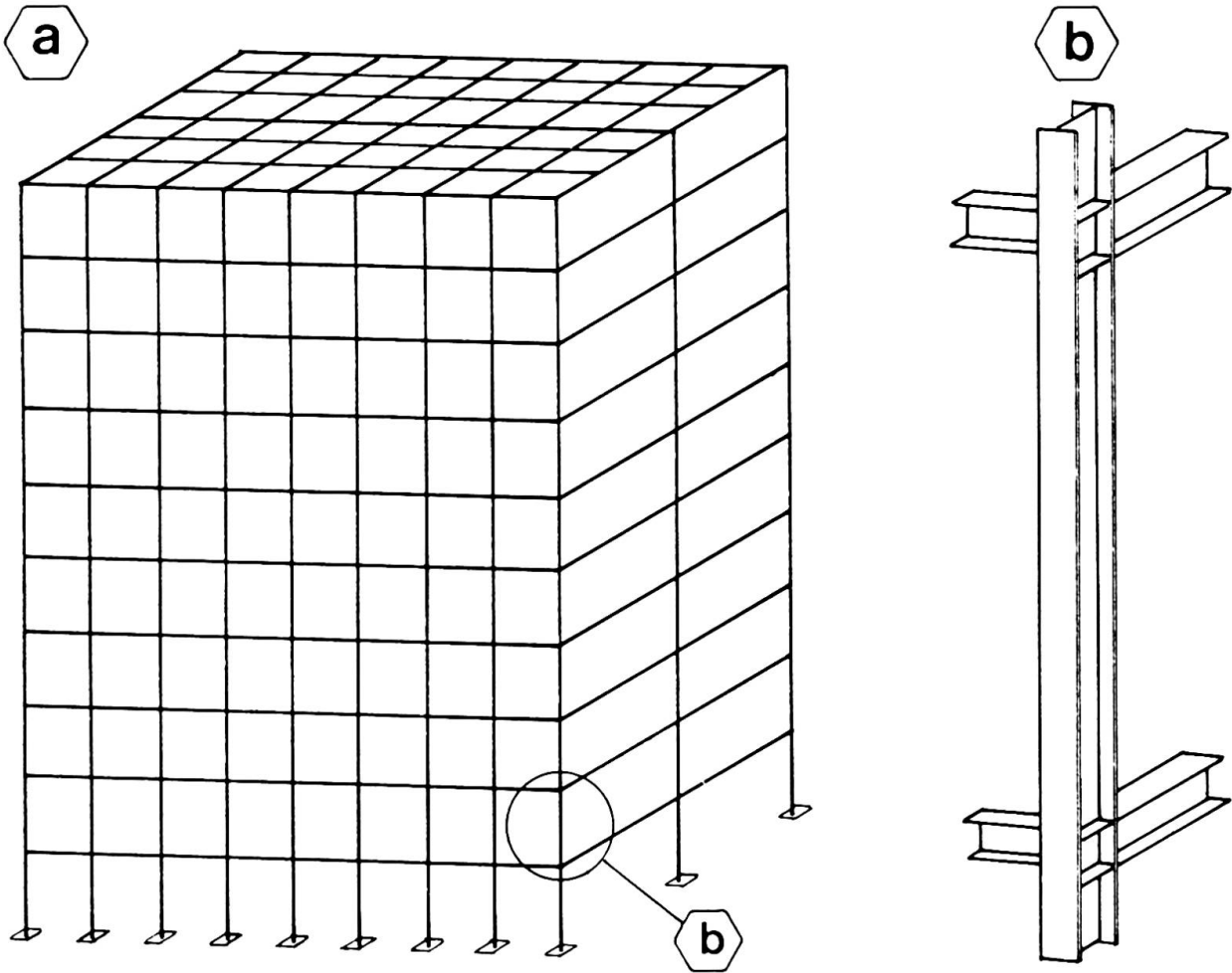

Fig. 1

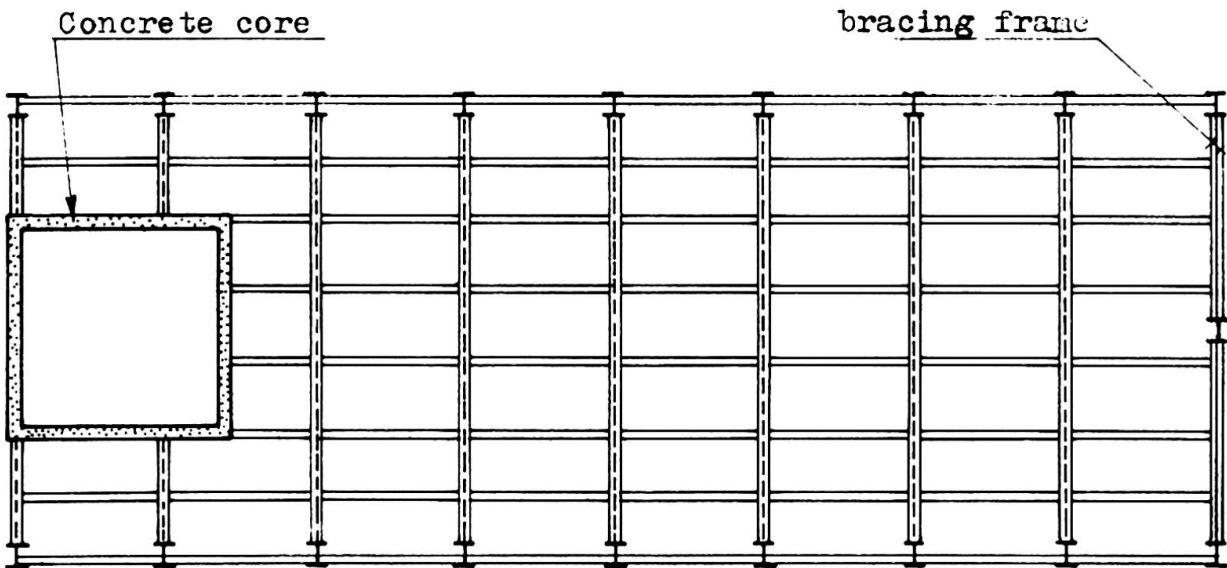

Fig. 2

The interactional behaviour that this paper is about stems from this omission.

A great deal of work has been done on the qualitative aspect of this subject. Its quantitative aspect, however, as received far less attention.

In effect, the designer is much more likely to turn to a single plane approach, because of the smaller number of unknowns present in calculation, and because it is easy to represent and to read. Also, in order to attain this result, he will accept simplifying hypotheses which, though they are often reasonable, sometimes may not be so.

There are cases in which neglecting this interaction between structural elements certainly leads to giving the structure as a whole larger dimensions than strictly necessary. In this respect a typical case is that of beam and slab bridges made up of a slab and a series of longitudinal beams side by side. The presence of loads which are mobile and flanked by others that are remarkably different (civil and military loads) leads, if this interaction is neglected, to giving such dimensions to all of the beams as would only be needed for those committed to the most heavily loaded trains.

Correctly evaluating and taking into account the effects of interaction is therefore fundamental for rational and economic designing.

A great deal of theoretical and experimental work has been done on this problem, which is still receiving considerable attention.

This can also be referred to large panel prefabricated buildings, where taking into account the stresses induced by horizontal forces (wind and earthquakes) in all the walls and correctly sharing out the loads among them, rather than entrusting this to apposite bracing walls, leads to a much wider range of architectural and distributive solutions. A considerable amount of research is being carried out in this particular field.

When working with one-dimensional, typically steel, elements, architectural and distributive requirements govern the designers choice of the number and position of the bracing structures. It would seem then that the problem of interaction would be of minor importance in this case.

Nevertheless these general requirements mentioned above often impose the insertion of shear trusses in eccentric positions unfavourable to an equitable distribution of the horizontal forces. They also discourage the mutual collaboration of structures in reinforced concrete, such as stair cases and elevator wells, with steel trusses or frames (fig. 2). Less work has been done on this problem than might be thought, with the result that bracing systems are often overdone.

However, there are cases in which the effects of interaction do not greatly improve the static commitment of those structures favoured by the process of interaction itself, but noticeably overburden the elements called in to help them.

This happens, for example, in large span factory roofs supported by reinforced concrete columns. Neglecting the friction forces of the supports, assumed to be frictionless, has sometimes led to splitting in the columns. This is because they impede the thermal deformations of the roof to a greater extent than the designer had allowed for.

Or again, everyone knows how frequent is cracking parallel to the reinforcement in the slabs of concrete and ceramic blocks (widely used as secondary elements in mediterranean countries) adjacent to the edge beams, i. e. in those areas where the beams tend to make the slab act as a plate, a function for which it was not designed.

These examples confirm that it is a question of sins of commission against the compatibility of displacements and strains, the more serious in their consequences as the material involved is more brittle, and thus important in composite structures of steel and concrete.

Nevertheless, there can also be serious drawbacks for metal structures at least in the presence of geometrical second order effects or corresponding to the presence of plastic flow. Thus for example in a tower, such as the one shown in plan form in fig. 2 the resistance to wind action can be largely entrusted to the core walls containing the staircase and utilities located at one side.

This core wall will furthermore be heavily subjected to torsional stress and, in the more distant transversal frames, will give rise to a  $P-\Delta$  effect of considerable importance for the purposes of the limit design of the structure as a whole.

In this category there are also the instability phenomena (lateral buckling) which arise in thin partitions following elastic or thermal deformations in the loadbearing structure when suitable steps have not been taken to prevent it (figs. 3 a and 3 b).

Having shown, by means of examples, the essence of the phenomena in question, it seems suitable to refer to the following categories of problems.

a) Interaction in multi-storey buildings between beam-column frames, shear trusses, and concrete walls, in the resistance to lateral forces.

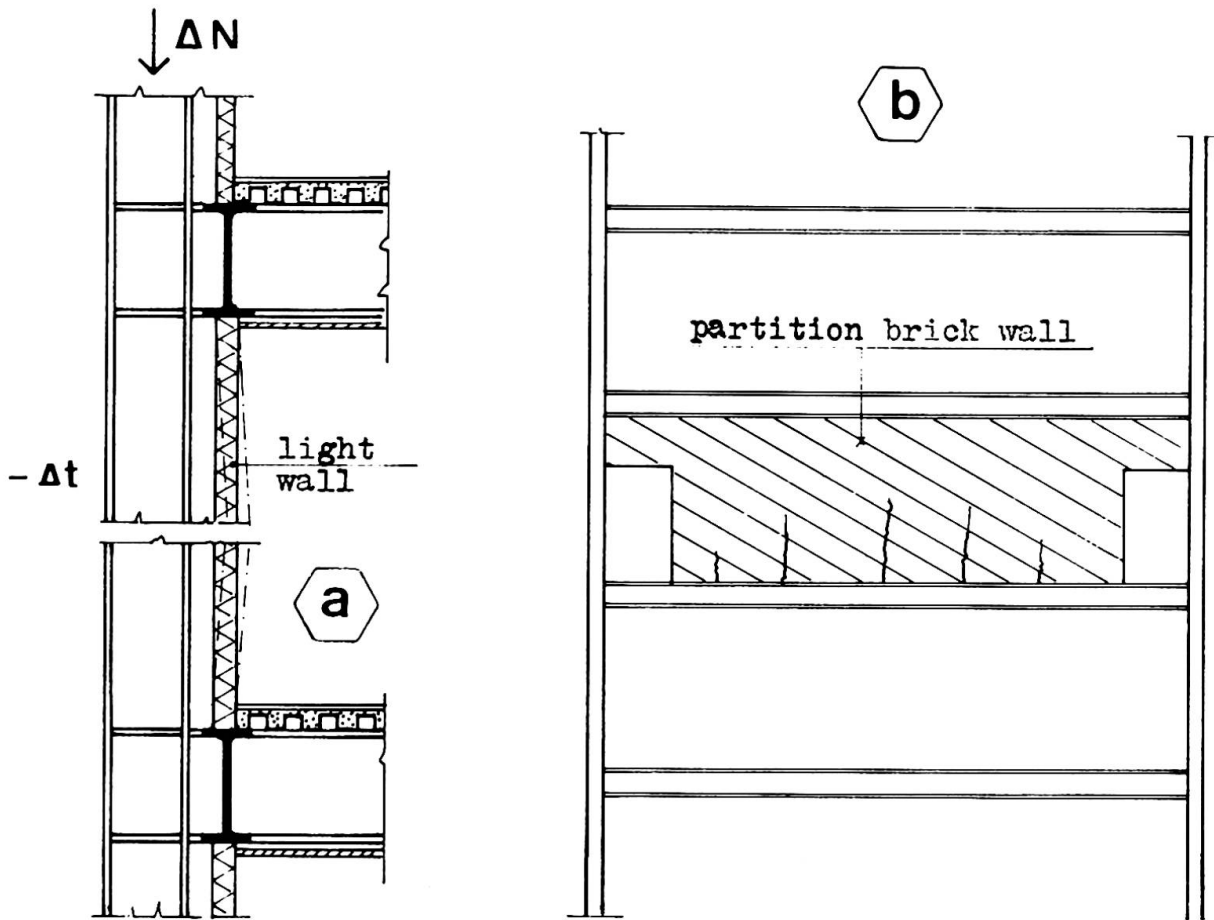

Fig. 3

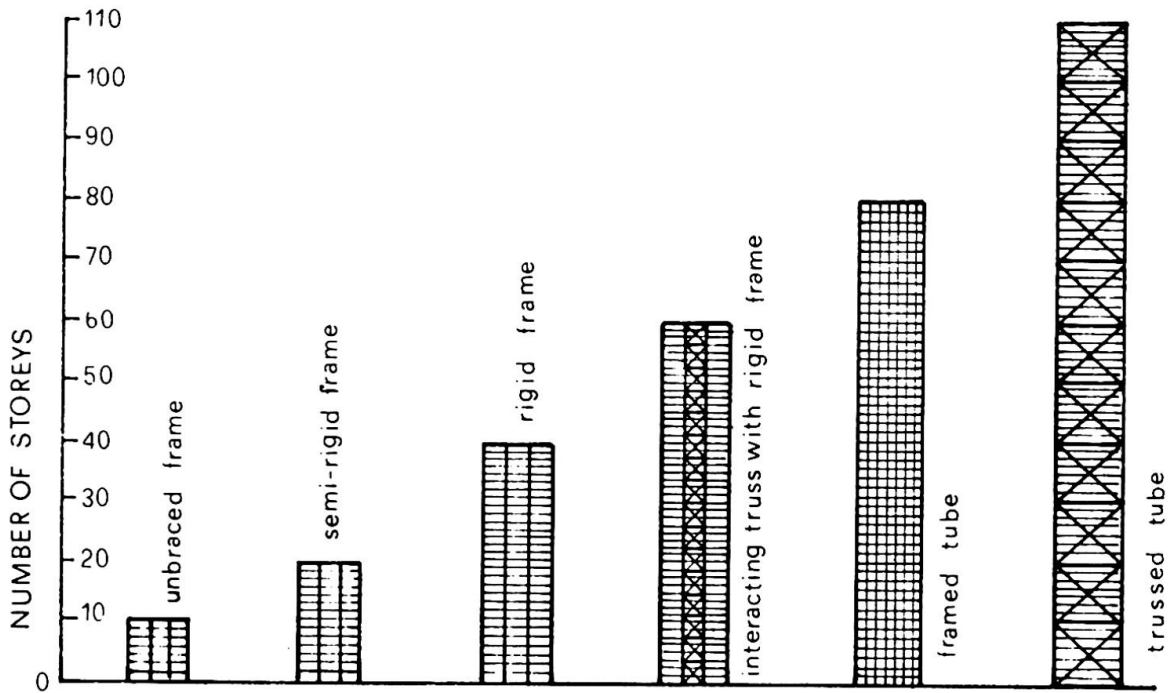

Fig. 4

- b) Interaction between the beams of bridge decks when faced with moving loads.
- c) Interaction between beams and slabs or roofings and between columns and wall decking when faced with instability phenomena.
- d) Interaction between the structure and the soil.
- e) Interaction between loadbearing structures and nonloadbearing elements.

## 2. Bracing systems for high-rise buildings

In tall buildings the premium for height is very much tied to the type of wind bracing used, and the best solutions vary with the height. The question has been thoroughly treated by F. R. Khan and others [1] [2] [3] [4] [5] [6] [7] [8].

In particular the suitability of various types of vertical wind bracing (fig. 4) has been quite well gone into, while the discussion is still open on the limits within which apposite horizontal floor bracing (fig. 5) can be left out for transferring the forces acting on each floor to the wind bracing.

American examples, the World Trade Center in New York and the U. S. S. Headquarters building in Pittsburgh, seem to show that, for massive constructions the problem does not exist. However, it should not be forgotten that in buildings that are so compact and rich in wind bracing, the slab floor is much less called upon to participate than in a European type of building with an extended rectangular plan and without rigid joints.

Another problem that is still open involves thermal effects in the structures of tall buildings. This becomes particularly important when one part of the structure is exposed and another is not [9].

In this respect for example it is to be feared that the advantage to the wind bracing system deriving from the use of rigid cap trusses (fig. 6) will be greatly reduced.

An interesting but infrequent case is that of buildings with a central concrete or steel core and cap horizontal trusses from which the lower floors are suspended by tendons. If a "rigid frame" is adopted interaction effect may be of great importance due to the contrary behaviour of the external vertical structures whose tensile axial load increases from the bottom to the top of the building and the interior ones which are increasingly compressed from the roof to the basement.

A similar lateral force distribution problem arises in large factory buildings, especially when containing heavy cranes. In this event a careful evaluation of the effects of interaction between the columns, both transversally

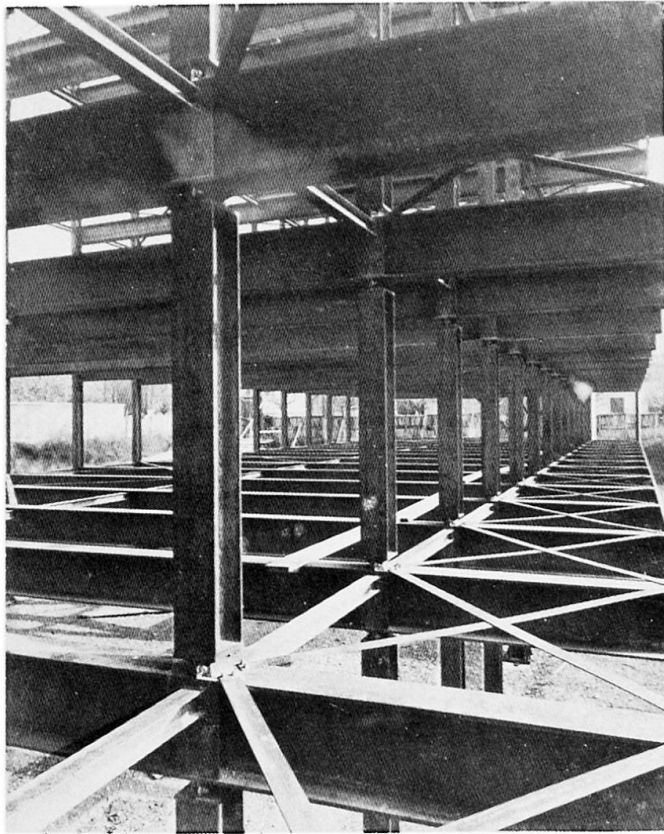

Fig. 5

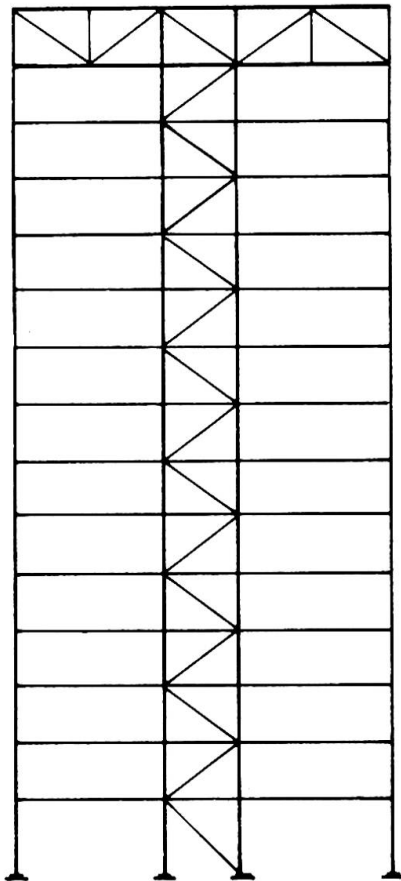

Fig. 6



and longitudinally, can be very rewarding [10]. Such an interaction can be obtained by using either opportune roof bracings or the horizontal bracings of the crane runways. Minor details may be of great importance [11].

It can be said then, that the greatest advantages are obtained when, as in the above case, there are moving loads or loads concentrated in limited areas.

A case of this type arises for great aircraft hangars, where wind forces act in widely varied ways depending on wind direction and whether or not the doors are open. In this sort of case diffused wind bracing (fig. 7) produces the best interaction effects.

### 3. Bridge decks

For bridge decks, whether of the "beam and slab" (fig. 8 a) or the "box girder" (fig. 8 b) type, the problem of the distribution of wheel loads, or the effects of interaction between side by side longitudinal beams, has been studied very thoroughly, both experimentally and theoretically in the last 25 years. The recent Report 83 of the U. S. A. Highway Research Board [12] quotes almost 300 papers on the subject. These studies have been carried out with differing approaches: orthotropic plate analysis, articulated plate theory, equivalent grid system, harmonic analysis and numerical moment distribution, prismatic folded-plate theory, beam on elastic foundation analogy, ecc. . . .

The present state of knowledge seems satisfactory for small and medium span (40 m.max) supported floor systems of highway bridges. But this is not true for the large spans and multicellular cross sections used for very wide bridges. There are some problems of interaction still open, too, for skew bridges [13] and curved girder bridges [14] [15] which are far from being infrequent. Finally, behaviour in the case of continuity and for portal frame bridges is also being studied as the secondary moments in the bridge due to its flexibility and the eccentricity of the loading are not equally reduced [16] [17]. It is felt that the assumption that the effective length of the bridge for load distribution effects is the distance between points of contraflexure should be clarified through future additional theoretical work.

Particularly difficult, for the effect of interaction phenomena, are the large span orthotropic steel plate deck bridges. Here in fact, the deck plate and the longitudinal ribs are subject to a double interaction effect i. e. the deck as a part of the main carrying members (system I) with either the deck as the bridge floor (system II) or the deck plate acting between longitudinal ribs (system III).

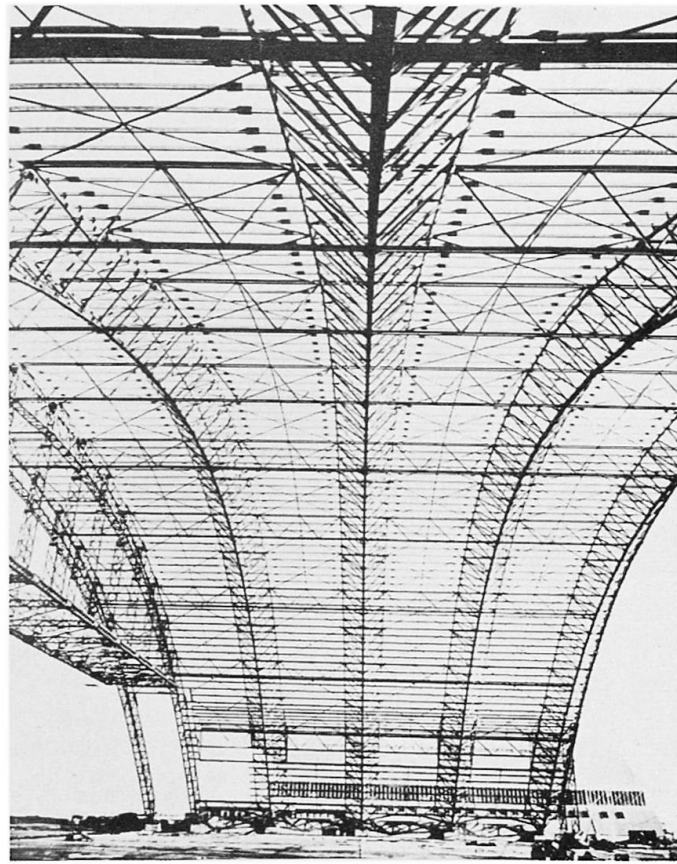

fig. 7

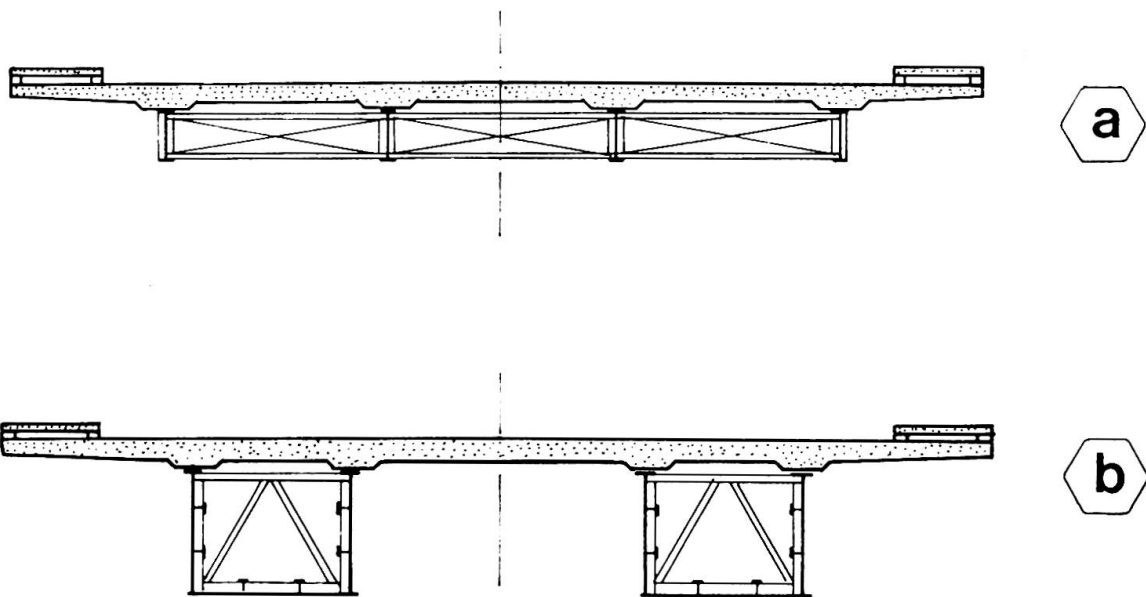

fig. 8

These three systems when loaded differ substantially because both the second and the third draw great static resources from geometrical second order effects and plastic adaptation.

That is, highly concentrated loads are supported [18] [19] [20] [21] by means of membrane behaviour and local yielding of steel which improve in an extraordinary way the static resources of the structure, so much so that, based on experimental results [22], the largest bridges of this type [23] [24] have been designed by reducing to a half or even less the stresses calculated in the first order approach for system II and those of system III have even been left out completely in calculating the maximum total stresses.

It seems that in this sector, so important for the development of steel bridges, a great deal of theoretical and experimental research is to be hoped for, and the problems bound up with fatigue and shake down phenomena should not be neglected.

#### 4. Roof decking and wall cladding bracing effect

It is by now quite frequent for the roof deckings of light gage corrugated sheets to be fastened to beams of the roof by plug welds, shot nails or rivets with the intention of giving the roof decking the function of ensuring the lateral stability of the beams as well as the job of sharing out the horizontal forces due to wind or earthquakes to the vertical structures. This leads to the elimination of the roof bracings (fig. 9) which, usually, in order to avoid interference with the purlins and girders of the roof, call for construction details (plates and ribs) that are expensive and out of proportion to the dimension of the bracing members themselves.

In this field interesting studies and experiments have been started in the U. S. A. at Cornell University [25] to establish the limits within which a light-gage steel roof or floor decking can restrain lateral buckling of truss chords, beams and purlins. It seems that the interaction of a shear-resistant metal diaphragm made up of corrugated sheets can produce a several-fold increase (6 to 8 times) in carrying capacity and the yield moment of beams appears to be readily obtainable.

Equally brilliant results have been obtained at Cornell [26] [27] [28] [29] by studying the behaviour of columns directly connected by corrugated sheets or by horizontal purlins and corrugated sheets.

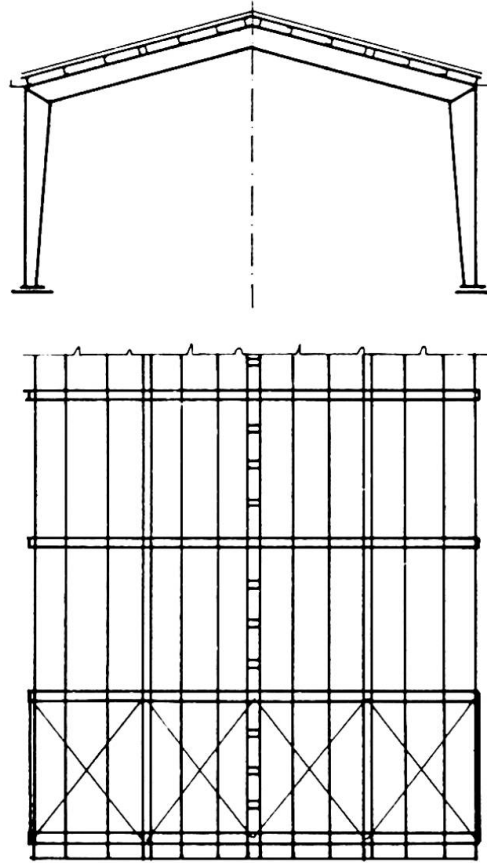

fig. 9



fig. 10

The weak axis buckling of columns is prevented up to the elastic limit load. Above the elastic limit load the influence of diaphragm bracing is less pronounced and less predictable. If diaphragm bracing are connected to girts, which in turn are connected to the columns with a twist-restraining column girt connection, the critical load may be increased to that of a column having an effective length equal to the girt spacing.

The results from the above research have been very encouraging, and it is to be hoped that the work will be pursued until arriving at sufficiently simple calculating rules. Nevertheless, it seems that, while in the case of the beams the presence and therefore the efficiency of shear-resistant diaphragms can be guaranteed in time, the same cannot be said for the columns where the need to open doors or windows can substantially modify the original situation.

But the interaction between cladding and main structure to ensure the overall functioning of the wind bracing of the structure does not yet seem to have received systematic treatment, even if there are structures with even very large spans (fig. 10) which rely on this. It is certainly to be hoped that the question will be looked at theoretically and experimentally in the future.

##### 5. Soil structure interaction

Interaction effects similar to those mentioned above between main and secondary structures, or between structures functioning in parallel, also arise between the structure and its foundation soil.

They are effects that are known and studied only with reference to particular cases [30] [31] [32] [33], but important for all that. They regard two materials that are widely differing in their behaviour (steel or concrete and soil) especially when faced with creep and relaxation phenomena.

Consider for example a steel skeleton frame construction with hinged connections that has columns founded on independent footings and so dimensioned as to commit the soil homogeneously and so that the bulbs of pressure do not significantly interfere with each other. The fact that one column is submitted to a maximum live design load while those adjacent to it are subjected only to the permanent loads will not substantially alter the state of stress in the steel structure above the ground, and thus there will be no appreciable interaction phenomena.

But now consider a construction with extremely rigid loadbearing structures, such as a silo for minerals (fig. 11).

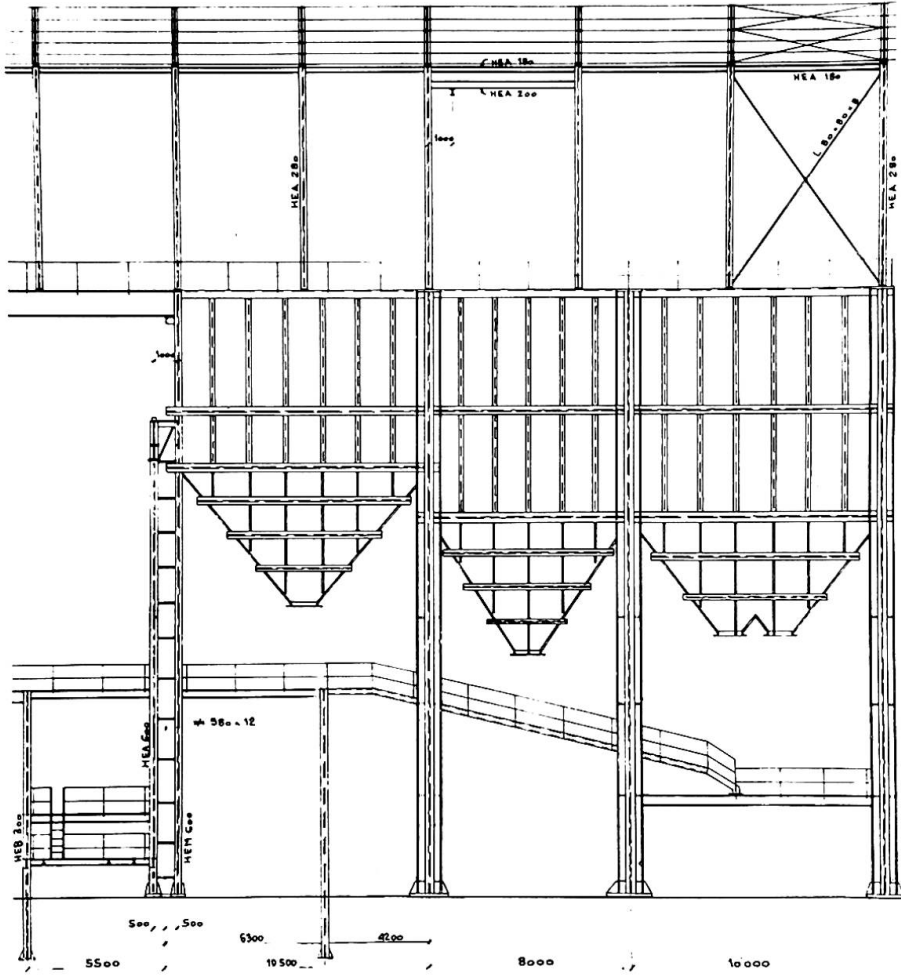

fig. 11

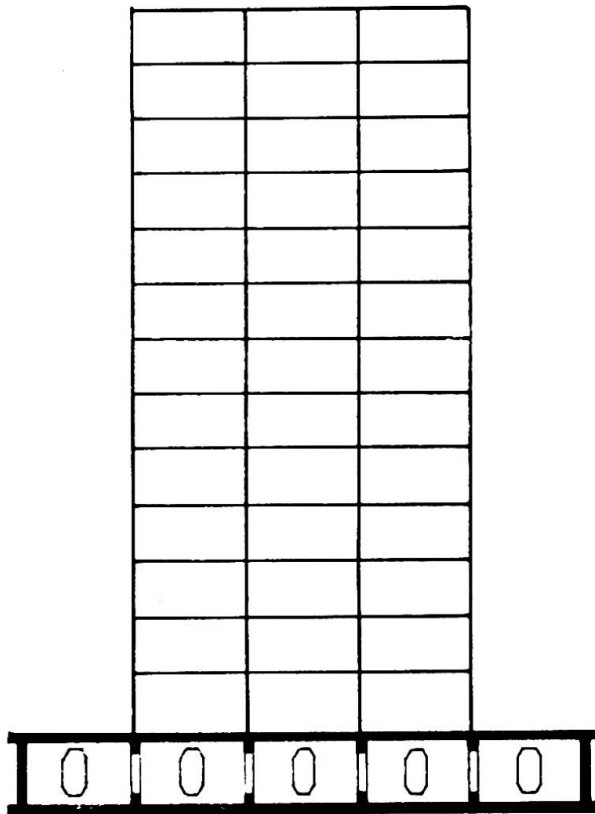

fig. 12

Here if isolated plinth foundations are used, it is practically impossible on the one hand to prevent the pressure bulbs interfering with each other, while on the other hand the rigid walls above the ground have a high power of distribution between the pillars.

It follows that live loads present in a limited central zone tend to transfer to the adjacent zones until reaching complete and uniform distribution between the columns and on the ground. The latter, however is more deformable in the central area, where the pressure bulbs interact, than at the perimeter. It can then be said that the perimeter pillars tend to be the most loaded.

Return now to the case of the hinged steel skeleton, but this time with a box-plate foundation (fig. 12) of great stiffness. Here the distribution of loads on the steel structure will have but little influence on the soil response and in this regard only the resultant in position and size will count. In these conditions the presence of live loads only in the central zone will lead to high bending moment and shear values in the box-plate. The shear will be particularly dangerous because, as is well known, in this kind of foundation the walls are impaired by the presence of doors or windows which give rise to important Vierendel effects.

These interaction phenomena are particularly worrying when the ground water level varies in time.

For example, over the last 20 years the level in Milan has fallen by about 25 m. and the same thing happens in cities where the water is drawn from the sub-soil.

The consequent ground settlement which is without linear characteristics, especially if the stresses in the zone are not uniform, profoundly modifies the state of stress of structures on it, because it leads to relative vertical displacements in the order of centimeters.

The cathedral of Milan is in this situation, and costly repair work is going on to strengthen the structures concerned (main arches and main columns) and to arrest the movement of the relative foundations.

Finally it should be remembered that during the construction of a building the stiffness ratios between structure and soil vary continuously in the sense that creep phenomena in time diminish soil rigidity, but the rigidity of the building increases as the structures are erected and connected with wind braces, so that even this aspect of the problem should not be neglected in designing.

Furthermore the behaviour of the foundation soil is in general substantially modified when new buildings are constructed beside those already there, as happens for example when a warehouse is extended.

Even if this is a field at the border between structural engineering and soil mechanics, it seems to deserve more attention from engineers and research workers than it has so far received.

## 6. Non structural elements

The interaction between those elements which are structural and others which are not, that is between load bearing structures and finishings such as floors, partition and curtain walls, ceilings, is generally undesirable in that it can lead to disconnections, cracks and ruptures in the non-loadbearing elements. For these reasons curtain walls, for example, are designed as elements to be hung from the perimeter of the loadbearing structure with suitable expansion joints to allow free expansion. Similarly the partition walls are clamped to the slabs or the beams of the upper edge by highly deformable elements (springs and padding) which reduce to reasonable limits the loads absorbed by the partition wall in relation to its connection with the upper slab without making it break away from the latter when the lower slab is more heavily loaded. This expedient avoids the inconveniences mentioned in the introduction (figs. 3 a and 3 b).

In the same way the interaction between the slab and the flooring may give rise to cracks in the latter corresponding to the areas of negative moment. This happens when floating floors are not used, nor suitable expansion joints in the floor itself.

Nevertheless there are cases in which the interaction between masonry walls and the steel structures which support them can be advantageous. This is the case of brick walls stiffened by I beams and channels. Fig. 13 shows how a 12 cm thick masonry wall is supported on a free span of about 14 m by CNP 140 horizontal channels. Vertical tendons connect the upper and lower channel so as to suspend the dead load of the brick wall to an incorporated arch of which the lower channel is the tie. Actually this is quite a common way to obtain economic and well insulated exterior claddings but the study of such behaviour should be improved.

The same can be said about claddings obtained with exterior corrugated sheets connected to horizontal steel beams [34]. In this case obviously the decking acts only as a shear-resisting member while bending moment must be supported by the steel girts.



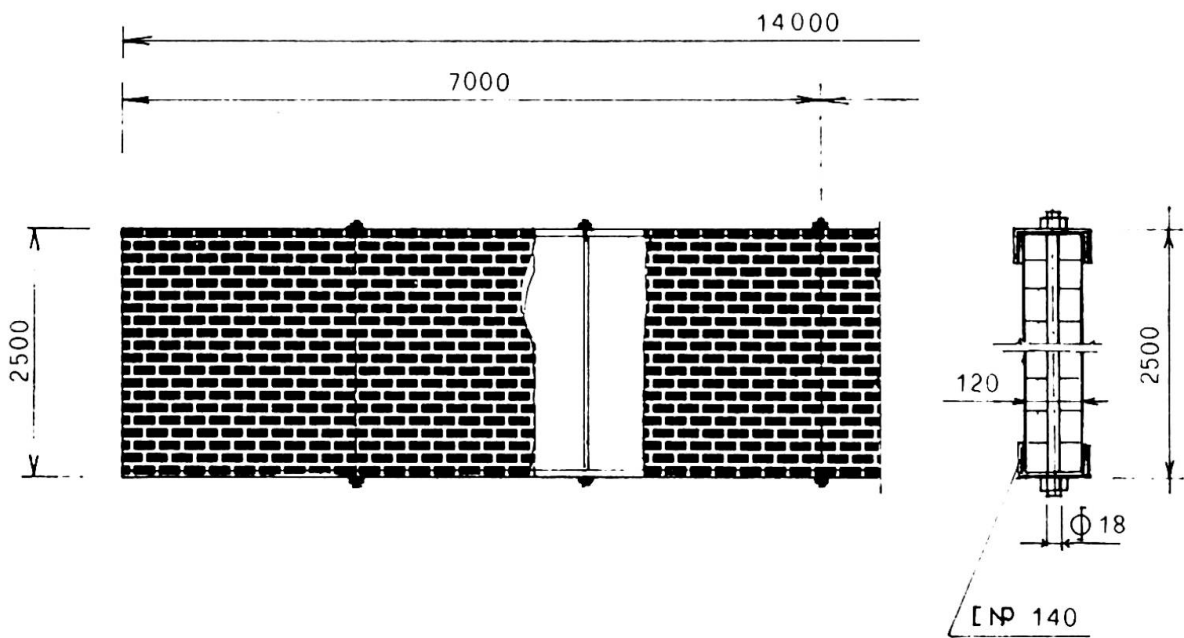
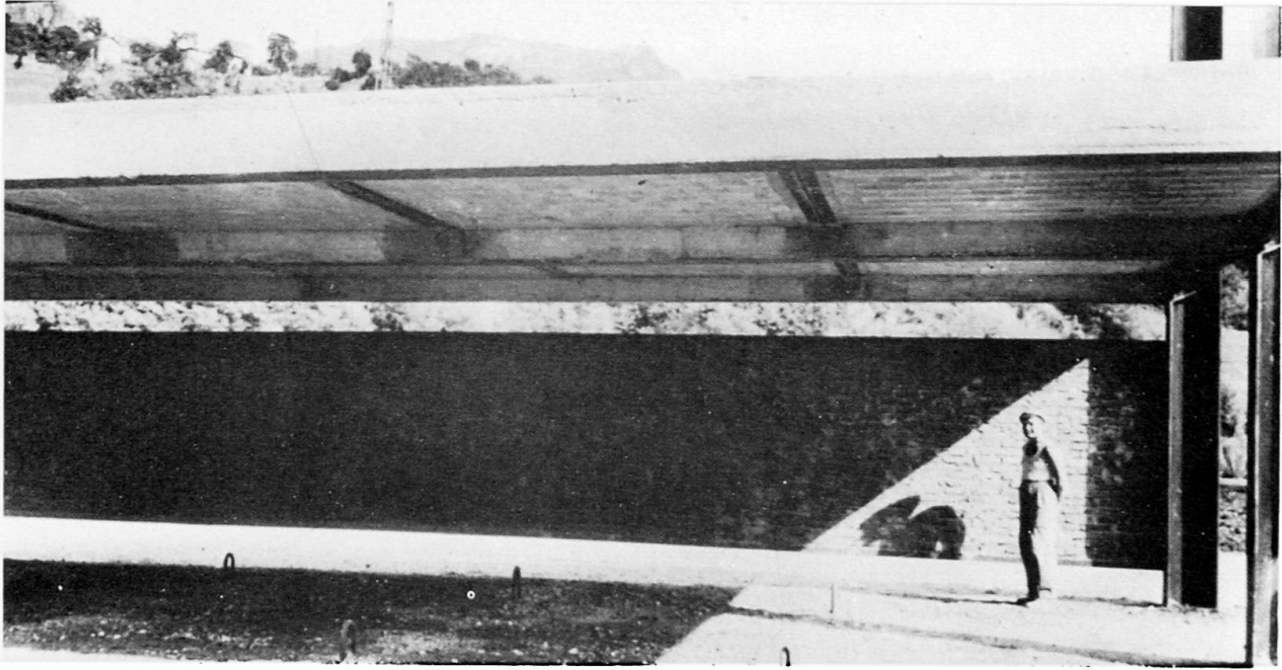

Fig. 13

## 7. Conclusions

This paper has been an attempt to set out certain favourable and unfavourable aspects of interaction phenomena which occur between parts of the loadbearing structure, between this and the soil or between the main loadbearing structure and secondary structural or non-structural elements.

It seems that the most studied aspects of this problem, as is only human, are those which, through interaction phenomena, lead to favourable results and so to more economical and rational construction. But those interaction effects that lead to the overstressing of structural and non-structural parts have been less studied.

Generally speaking more research has been done on housing and office blocks and on bridges. Much less studied are the problems that occur in factories where, however, it seems that a three-dimensional vision even of the present structural approaches might lead to considerable gains at least where the live loads are not uniformly distributed.

In general, then, it seems that considerable benefit might still be derived from a correct evaluation of the effects of interaction in the presence of dynamic actions (wind and earthquakes) not only in the evaluation of the deflections but also of the general collapse load.

The unfavourable effects of interaction due to temperature have also been too little studied.

These effects are growing in importance as the buildings rise in height and enlarge more and more, with part of the main structure free in the air.

Interesting work has been done, or is in progress, on the effects of interaction between decks and beams, and claddings and columns.

In many cases lateral stability of the beams can be ensured simply by suitably fixing the decking to them, and it seems probable that this will lead to safe design in this field. It is certainly to be hoped that this research will be extended.

The importance of preventing the weak axis buckling of columns through the bracing effect of cladding and purlins seems to be interesting only for smaller factories and one-storey buildings.

The need to ensure that the cladding is not removed makes it, in fact, too great a drawback for the user.

The interaction between soil and structure should receive more attention from the structural engineer, especially today when industrialisation has led to the construction of big industrial plants in zones, such as river mouths, where the ground may in time prove to be particularly yielding.

Interactions between loadbearing structure and finishings are generally undesirable. The designer should, with certain exceptions, try to avoid them or contain their effects, but to be able to do so more knowledge is required of the static response of non static materials.

### 8. Aknowledgments

In concluding this report the author wishes to thank his colleagues H. Beer, S. J. Errera, F. R. Khan, J. R. Novak, W. W. Sanders, M. G. Salvadori, I. M. Viest, who kindly informed him of the work they had in progress or of which they had notice and gave suggestions on arguments of interest in the field. He is also grateful to the American Institute of Steel Construction and to the European Convention of Constructional Steelwork Associations for the opportunity he had to get fresh information in the field at the 22 nd AISC National Engineering Conference (Pittsburgh, May 1970) and at the C. C. S. A. General Assembly (Düsseldorf, June 1970).

### 9. References

- [1] F. R. KHAN and J. A. SBAROUNIS - Interaction of shear walls and frames - Journ. ASCE, June 1964
- [2] F. R. KHAN, S. H. IYVENGAR and J. P. COLACO - Analysis and design of the 100-storey John Hancock Centre in Chicago (U. S. A. ) - Acier Stahl Steel, June 1968
- [3] F. R. KHAN - Recent structural systems in steel for high-rise buildings - BCSA Conf. on steel in Architecture - London, Nov. 1969
- [4] F. R. KHAN - New systems for steel framed building - 22 nd A I S C Nat. Eng. Conf. - Pittsburgh, April 1970
- [5] F. DE MIRANDA e A. G. BOLOCAN - In sintesi i moderni criteri di progettazione delle strutture in acciaio negli edifici multipiano - Costruzioni Metalliche - N. 3 - 1969
- [6] C. MASSONET - Les perspectives de la construction métallique - Annales des travaux publics de Belgique - N. 3 - 1968/69
- [7] A. RUTENBERG - Multistory frames and the interaction of rigid elements under horizontal loads - M. Sc. Thesis, Technion - Israel Institute of Technology - Haifa 1966

- [8] A. BEN - ARROYO - Preliminary wind analysis of multistorey bents - Engineering Journal A. I. S. C. - N. 1 - 1970
- [9] E. R. LAUGHLIN and H. H. WEST - Temperature effects on high-rise buildings AISC Nat. Eng. Conf. - Pittsburgh, April 1970
- [10] I. MUNTEARM - Sulla ripartizione degli sforzi attraverso le controventature della struttura metallica di un capannone industriale - Acier Stahl Steel - N. 5, 1970
- [11] N. BALUT - Contributie la studiul grinzilor de rulare metalice - Doctor thesis Institutul Politehnic Timisoara - Roumanie - 1970
- [12] NATIONAL COOPERATIVE HIGHWAY RESEARCH PROGRAM REPORT 83 - Distribution of wheel loads on highway bridges - Highway Research Board - 1970
- [13] F. LEONHARDT - Neue tendenzen in Berechnung und Konstruktion von Weitespannten Brücken und Viadukten - 8th A. I. P. C. Congress Prel. Pub. , 1967
- [14] G. CERADINI e C. GAVARINI - Teoria dei ponti in curva a travi multiple - Costruzioni Metalliche, N.<sup>i</sup> 2, 3, 4, e 6, 1965
- [15] C. CULVER, D. BROGAN, D. BEDUAR - Analysis of curved girder bridges - Engineering Journal A, I. S. C. , N. 1, 1970
- [16] R. E. ROWE - Concrete bridge design - Wiley 1962
- [17] A. C. SCORDELIS - Analysis of continuous box girder bridges - Struct. and Mat. Res. Rep. SESM - 67-25, Un. of Cal. 1967
- [18] M. CAPURSO - Comportamento elastoplastico delle piastre sottili metalliche nel campo dei grandi spostamenti - Costruzioni Metalliche, N. 1, 1968
- [19] M. CAPURSO e R. RAMASCO - Il calcolo elastoplastico delle piastre metalliche nel campo dei grandi spostamenti attraverso le differenze finite - Costruzioni Metalliche N. 3, 1968
- [20] C. MASSONET - General Theory of elasto-plastic membrane-plates - Engineering plasticity - Cambridge Un. Press, 1968
- [21] M. CAPURSO e R. RAMASCO - Sul collasso elastoplastico delle piastre metalliche compresse al perimetro - Costruzioni Metalliche N. 2, 1969
- [22] K. KLÖPPEL - Über zulässige spannungen im Stahlbau - Stahlbau Tagung Baden-Baden, 1954 - Stahlbau Verlag, Köln 1958

- [23] W. PELIKAN and M. ESSLINGER - Die Stahlfarbelm, berechnung und konstruktion - M. A. M. Forschungsheft N. 7 - 1957
- [24] H. BEER - Die Europabrücke über dem Silltal in Tirol - Der Bauingenieur, Vol. 36, 1961
- [25] G. PINCUS, G. P. FISHER - Behavior of diaphragm-braced columns and beams - Proc. A. S. C. E. , Vol. 92 - April 1966
- [26] T. V. S. R. APPARAO - Tests on light-gage steel diaphragms - Rep. n. 328, Dep. of Str. Eng. Cornell Un. - Dec. 1966
- [27] S. J. ERRERA, G. PINCUS, G. P. FISHER - Columns and beams braced by diaphragms - Proc. A. S. C. E. - Vol. 93, Feb. 1967
- [28] L. D. LUTTRELL - Strength and behavior of light-gage steel diaphragms - Cornell Eng. Res. Bull. , 67-1 - 1967
- [29] T. V. S. R. APPARAO, S. J. ERRERA, G. P. FISHER - Column braced by girts and diaphragms - Proc. A. S. C. E. - Vol. 95, May 1969
- [30] E. SCHULTZE - Beispiele für Setzungsbeobachtungen in bindigen und nicht-bindigen Böden - Proc. of the European Conf. on Soil Mech. and Found. Eng. - Wiesbaden 1963
- [31] H. SOMMER - A method for the calculation of settlements, contact pressures and bending moments in a foundation including the influence of the flexural rigidity of the superstructure - Proc. 6th Int. Conf. on Soil Mech. and Found. Eng. - Montreal 1965
- [32] J. FELD - The factor of safety in soil and rocks mechanics - Proc. 6th Int. Conf. on soil mech. and found. Eng. - Montreal 1965
- [33] S. CHAMECKI - Calcul des tassements progressifs des fondations, en tenant compte de l'interaction des structures et du sol - Annales de l'Institute technique du bâtiment et des travaux publics -N. 261, 1969
- [34] C. MASSONET - Poutres de grandes dimensions a ame mince - 8th A. I. P. C. Congress Prel. Pub. 1967

## Summary

The report deals with the interaction of different structural elements and assemblies so as to avoid on the one hand overdimensioning and on the other hand overstressing of structural elements. The interaction between frames, bracings, walls, floor slabs, and roofing in buildings, halls and sheds is considered as well as between main girders, bracings and floor slab decks in bridges, and also between the main structure and the soil. Parasitic effects are finally discussed concerning secondary structural or not structural elements.

## Résumé

Ce rapport concerne l'étude de l'interaction entre éléments et ensembles structuraux. Cela vise à éviter d'une part le surdimensionnement et d'autre part les tensions excessives dans le calcul des structures. On considère l'interaction entre les cadres, les contreventements, les parois, les dalles et les toitures des bâtiments; de même pour les ponts, entre les poutres principales, les contreventements, les entretoisements, et le tablier. On discute aussi de l'interaction particulière qui se produit entre la structure et le sol. On considère finalement l'interaction entre les éléments soutenus par la structure et la structure elle-même.

## Zusammenfassung

Dieser Bericht betrifft die Wechselwirkung zwischen Bauteilen und Bauten, mit dem Zweck, einen rationalen Entwurf, ohne Ueberdimensionierung einerseits oder Ueberbelastung andererseits zu erlauben. Die Wechselwirkungen zwischen Stockwerkrahmen, Windverbänden, Wänden, Decken und Dächern in Gebäuden, Hallen und Shedkonstruktionen, zwischen Hauptträgern, Windverbänden und Decken von Brücken, und auch zwischen Hauptkonstruktionen und Baugrund, werden betrachtet.

Die Nebenwirkungen auf sekundäre Bauteile und nicht zum Bauwerk gehörenden Elementen werden ebenfalls diskutiert.

Leere Seite  
Blank page  
Page vide