

Zeitschrift: IABSE congress report = Rapport du congrès AIPC = IVBH
Kongressbericht

Band: 10 (1976)

Artikel: Erection method of prefabricated concrete arch bridges by using a
pretensioned cable truss

Autor: Watanabe, A. / Idemitsu, T.

DOI: <https://doi.org/10.5169/seals-10481>

Nutzungsbedingungen

Die ETH-Bibliothek ist die Anbieterin der digitalisierten Zeitschriften. Sie besitzt keine Urheberrechte an den Zeitschriften und ist nicht verantwortlich für deren Inhalte. Die Rechte liegen in der Regel bei den Herausgebern beziehungsweise den externen Rechteinhabern. [Siehe Rechtliche Hinweise.](#)

Conditions d'utilisation

L'ETH Library est le fournisseur des revues numérisées. Elle ne détient aucun droit d'auteur sur les revues et n'est pas responsable de leur contenu. En règle générale, les droits sont détenus par les éditeurs ou les détenteurs de droits externes. [Voir Informations légales.](#)

Terms of use

The ETH Library is the provider of the digitised journals. It does not own any copyrights to the journals and is not responsible for their content. The rights usually lie with the publishers or the external rights holders. [See Legal notice.](#)

Download PDF: 02.02.2025

ETH-Bibliothek Zürich, E-Periodica, <https://www.e-periodica.ch>

Erection Method of Prefabricated Concrete Arch Bridges by Using a Pretensioned Cable Truss

Méthode de préfabrication d'un pont en arc, en béton, à l'aide d'un système porteur de câbles tendus

Herstellung einer Bogenbrücke aus Fertigteilen mit Hilfe eines vorgespannten Kabelträgers

A. WATANABE T. IDEMITSU
Professor Associate Professor
Kyushū Institute of Technology
Tobata, Kitakyushu, Japan

Introduction

There are a great number of narrow bays and deep valleys suited to be constructed concrete arch bridges in Japan, and the bridges have some good characteristics such as beautiful shape, no maintenance expenses etc., however only a few of them have been constructed in this country. The authors consider the main reasons of this fact as follows. The construction of a centre for a concrete arch needs a lot of time, labor and money, and the field works of cast-in-place concrete in an arch is quite difficult.

They have been studying the pretensioned cable truss (the PCT) for about ten years. As a result, it is found that wind resistance of the PCT is excellent and its displacement with live load is comparatively small. And these characteristics are good for the erection of bridges, therefore, they attempted to build up a prefabricated concrete arch bridge by using the PCT.

2. Pretensioned Cable Truss

The PCT was devised by the authors and was originally intended to be as a temporary structure for the erection of bridges. It can be briefly considered as a suspension bridge having the lower cables instead of the stiffening frames. An example is shown in Fig.2. Upper and lower cables are connected with several hangers in which tension meters and turnbuckles are inserted, and the cable truss is formed. The necessary amount of pretension is introduced into the truss by operating jacks and chainblocks inserted at the end of upper cables and in hangers respectively, controlling the tension of hangers with the meters inspection.

The erection system is generally composed of two PCT in parallel and cross beams are laid across them. This method enables the work in a suspended state to be done as safely as on the ground.

3. Division of concrete arch into precast blocks

After the ordinary design of the concrete arch bridge is over, the arch is split into several strips of arch and, moreover, each strip is divided into

proper number of precast concrete blocks. The authors call the strip of arch " arch ring strip " for convenience. In the case when the arch ring strips are formed by assembling the blocks, the crookedness of it inevitably results and it must be adjusted, so the portion of arch crown and the joint parts between the arch and spandrel walls are of cast-in-place concrete.

Splitting of the arch must be done in order that the arch ring strip formerly finished can sustain those which are built up later at both sides of it. And the proper size of the blocks are determined by considering the capacity of carrying equipments.

For the connections between blocks, the method of using lap joints of steel bars or post-tensioning method has been tried and obtained good results. Further investigation is being continued.

4. An outline of the erection method of the bridge

Main steps of the works in the construction of a prefabricated concrete arch bridge is explained as follows.

- (1) At first, the PCT is designed and framed. At that time, it is necessary to calculate the most suitable amount of pretension and to determine the proper vertical position of cross beams so as to be laid along the lower surface of the designed arch.
- (2) In the case of the two hinged arch, hinges are placed for both ends of the arch.
- (3) Erection of the arch portion begins. Firstly, the blocks for an arch ring strip are built up. After the crookedness of it is adjusted, cast-in-place concrete for the part of arch crown is placed. The authors call this firstly made strip as " the fundamental arch ring strip " (just fundamental strip in brief). This work must be done as precisely as possible, or the works followed will become very hard. When the fundamental arch ring strip is built up and becomes to be supported by itself, the two strips made later at both sides can be sustained by the former one. Therefore, in this state, the PCT does not bear any load of the blocks and only play as falsework.
- (4) The erection works of other arch ring strips progress in order, as they are sustained by previously built up arch ring strips.
- (5) All the arch ring strips are built up and cast-in-place concrete is poured.
- (6) After spandrel walls are set up and the floor slabs of bridge are placed, the pavement work begins. Thus a prefabricated concrete arch bridge is completed.

5. Basic Experiment

5.1 Design of Model Arch Bridge

The authors firstly attempted to build up a small scale model arch bridge such as a footbridge. The design conditions were as follows.

Type of arch: two hinged arch. Span: 8.00m. Rise: 1.20m. Width: 0.80m. Load: uniform live load, 350kg/m².

The shape and dimensions of the model bridge designed under the conditions mentioned above are shown in Fig.1. Then, the arch of this bridge was split into four arch ring strips and each of them was divided into seven blocks. In this model, the block connecting method which mentioned before was not used, but the both ends of the each block were shaped into angles as shown in Fig.1. And, at

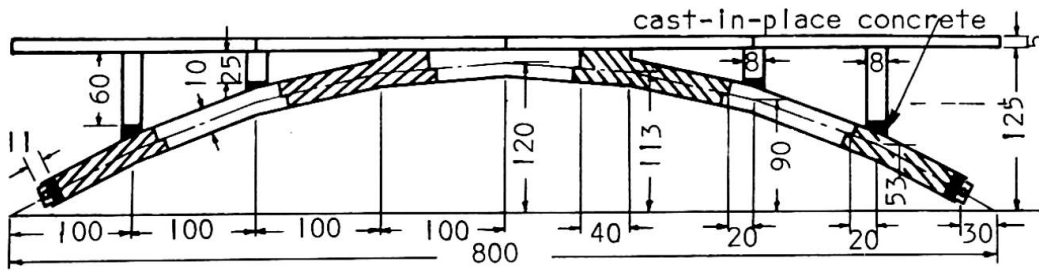

Fig.1 Model Arch Bridge

unit: cm

our convenience, cast-in-place concrete were not used for the portions of the arch crown, but at both ends of the arch. For spandrel walls, four of them were as long as they could be precast, but those near the arch crown were included in the crown blocks themselves as one body. For the bridge floor, only PC precast slabs (5cm x 20cm x 200cm) were used and just placed over the spandrel walls.

5.2 Manufacture of the Precast Blocks

The blocks were of reinforced light weight concrete and each of them weighed about 40kg. After assembling the form of an arch ring strip, concrete was firstly poured into the shaded portions and secondarily into the unshaded portions after three days as shown in Fig.1. At that time, the surface of hardened concrete at the joint parts was used as a part of forms for fresh concrete of adjacent elements. Thus, the crookedness of the joints in the erection works of the arch was avoided.

5.3 PCT used for Erection Works

Fig.2 shows the shape and dimensions of the PCT used for the erection works. A pretension of 200kg was introduced into each hanger, consequently, 2000kg of horizontal tension was induced in each main cable. The vertical positions of cross beams were determined that which dropped within the range of 5cm - 10cm under the lower surface of the arch, and vertically adjustable supports for the blocks were attached above to each cross beams. (Fig.3)

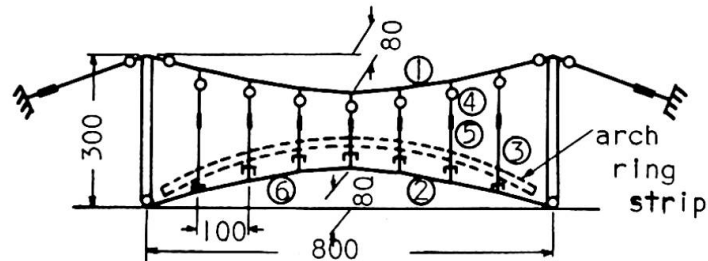

- ① Upper Cable
- ② Lower Cable
- ③ Hanger
- ④ Tension Meter
- ⑤ Turnbuckle
- ⑥ Cross Beam

unit: cm

Fig.2 Pretensioned Cable Truss

5.4 Measurements during Assembling Work of Fundamental Arch Ring Strip

Various measurements were carried out for three different cases.

- (a) The blocks of arch ring strip were put on the PCT from one end to the other in order, with connecting the joints.
- (b) The blocks were put on the PCT from both ends to the crown in order, with connecting the joints.
- (c) The blocks were put in the same way as in (b), but the joints were not connected during the work and were connected after the work was over.

For this experiment, the usual connecting method was not used, so an improved connection was done as shown in Fig.4. Namely, by using transverse bolts, steel channels were attached tightly to both lateral sides of each block, then prestress was introduced into the joint by using the longitudinal bolts,

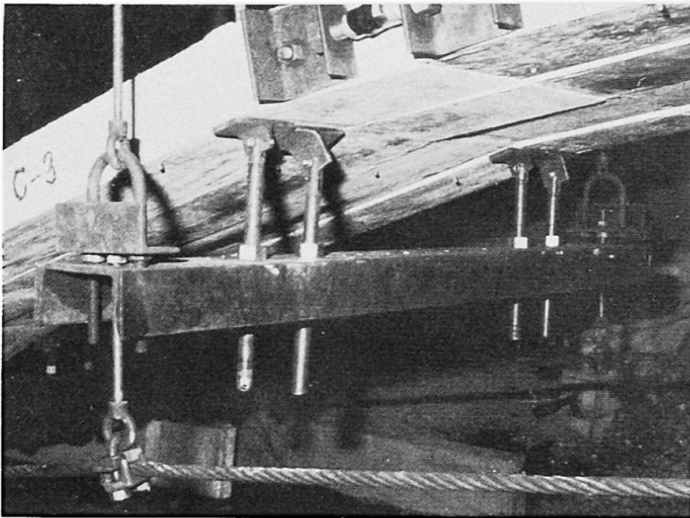

Fig.3 Supports for Precast Blocks

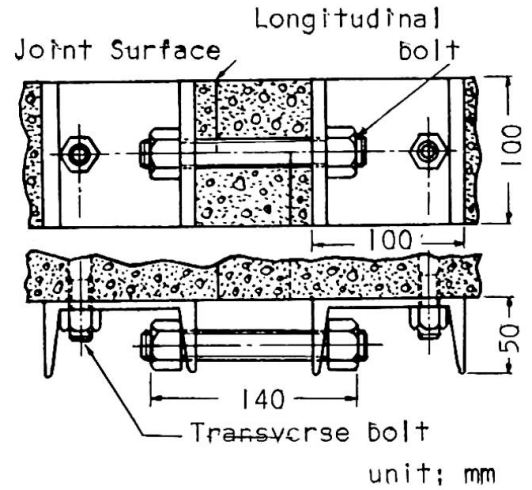

Fig.4 Improved Connection

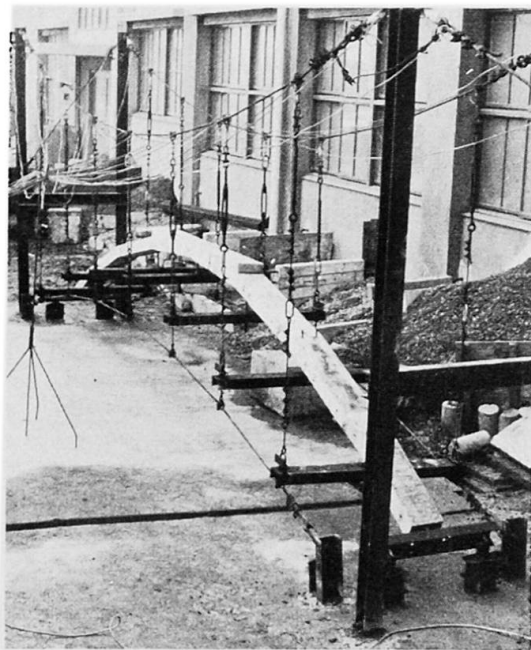

Fig.5 Fundamental Arch Ring Strip

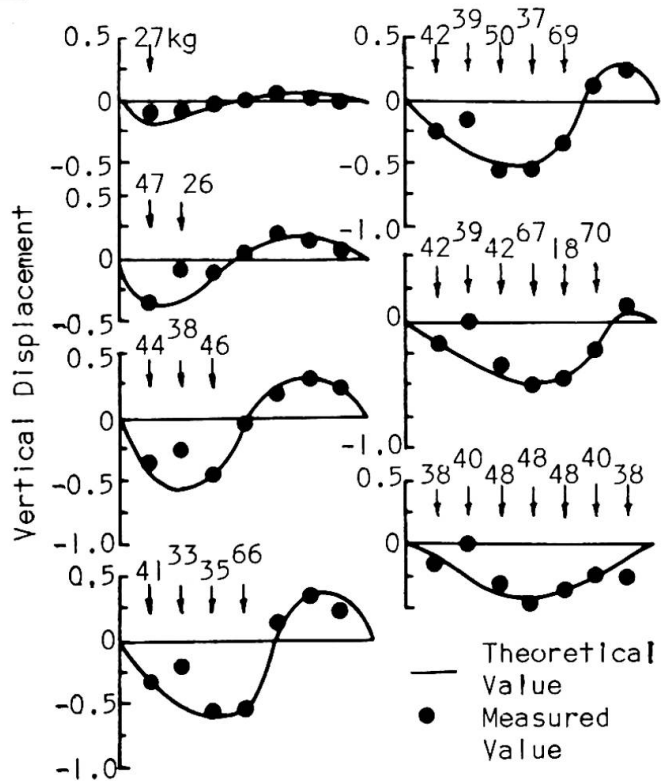

Fig.6 Vertical Displacement of Cross Beam (a)

consequently, the connected joints could be expected. Fig.5 shows a state when assembling work of the fundamental strip had just finished. Vertical displacements of cross beams in each case are shown as in Fig.6,7. In case of (a) (Fig.6), the value of maximum displacement is found about twice as large as in other cases (Fig.7). Therefore, the crookedness of the fundamental strip resulted easily in this case, and moreover, this work was comparatively difficult. Let us compare the cases (b) and (c). In Fig.7, measured values in the (c) case are nearer to the theoretical values than that of (b) case. The authors consider that the reason of this is as follows. In the (c) case, each block was only put on the PCT, but in the (b) case connected blocks played as a continuous curved beam during the work, which is undesirable because a compressive member of the arch will be subjected inevitably to not so small tensile stress during the erection works even

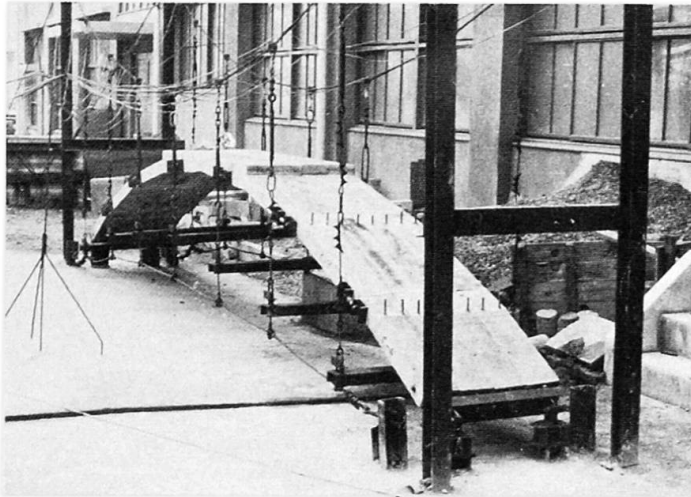

Fig.8 Whole Arch

temporarily. From these measurements, the (c) case is recommendable for the assembling method of the fundamental strip.

5.5 Built up Work of the Model Arch Bridge

After the investigation on the assembling work of the fundamental strip had been over, other strips, the blocks of which were sustained by adjacent strip, were built beside previous one. Fig.8 shows the whole arch built up in this way.

Cast-in-place concrete was made, the spandrel walls were set up and the PC slabs were placed over the spandrel walls. Finally the construction of this arch bridge was completed (Fig.9).

6. Conclusions

In this method, the PCT is used for the construction of a prefabricated concrete arch bridge and its key point is just in the assembling works of the fundamental strip. If this work is done

precisely, the other arch ring strips can be easily erected, as they are sustained by the previously built up one. As the results of the basic experiment, it was made clear that the fundamental strip had better be put from both ends towards the crown in order and be connected each other afterward.

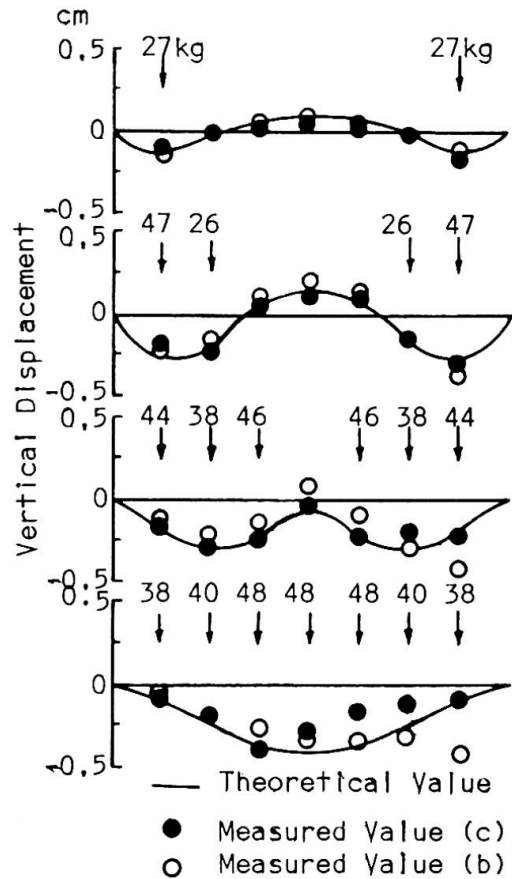

Fig.7 Vertical Displacement of Cross Beam (b), (c)

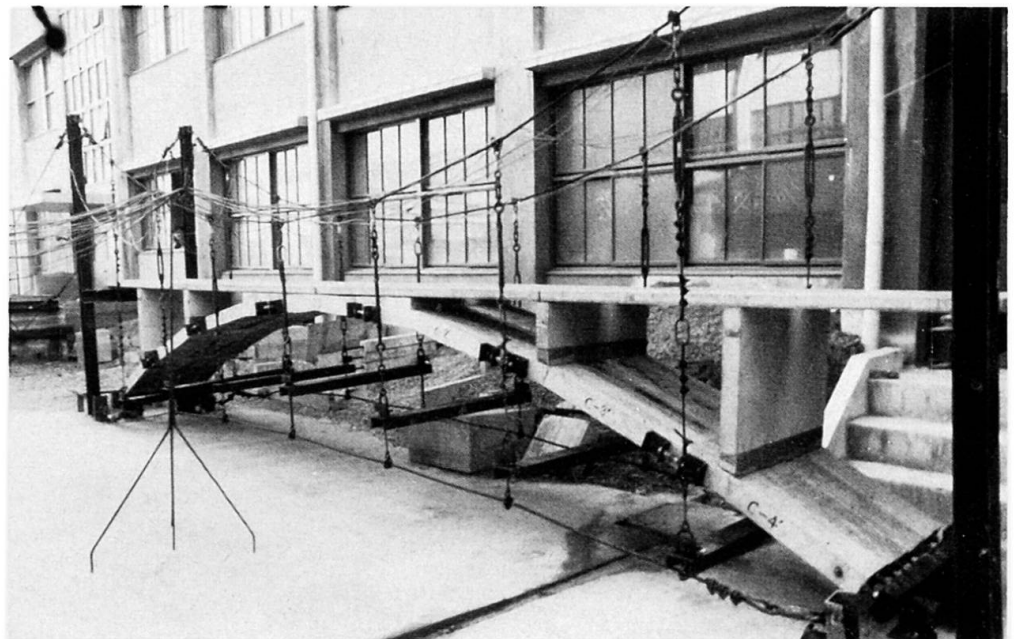

Fig.9 Model Prefabricated Concrete Arch

Although there may be some problems to be solved, the authors believe that this method will be applied practically in the near future.

References

- (1) A.Watanabe, T.Idemitsu, T.Ogami, K.Iida: Studies on the Safety Erection Method of Bridge by Composing the Pretensioned Cable Truss. Proceedings of the Japan Society of Civil Engineers, No.153, 1968
- (2) T.Idemitsu, A.Utsumi: Large Deformation Method for the PCT System. Bulletin of the Kyushu Institute of Technology, No.27, 1973

SUMMARY

The authors have been working on the "Pretensioned Cable Truss" since about ten years ago. It has been made clear that wind resistance of the PCT is excellent and its displacement with live load is comparatively small. These characteristics are useful for the erection of bridges: a prefabricated concrete arch bridge was therefore built using the PCT. The results of this basic experiment seem to allow a practical application in the near future.

RESUME

Les auteurs étudient un système porteur de câbles tendus depuis près de dix ans. Le résultat montre une très bonne résistance au vent du système et son déplacement dû à la charge de trafic est relativement petit. Ces caractéristiques sont favorables pour l'érection de ponts. Un pont en arc en béton a donc été réalisé avec un système porteur de câbles tendus. Le résultat de cette expérience fondamentale semble promettre une application pratique dans un proche avenir.

ZUSAMMENFASSUNG

Die Verfasser arbeiten seit zehn Jahren an der Entwicklung vorgespannter Kabelträger. Es hat sich ergeben, dass derartige Systeme einen grossen Widerstand gegen Wind haben, und dass Verformungen aus Verkehrslasten sehr klein sind. Diese Eigenschaften erlauben eine Anwendung beim Bau von Brücken. Eine versuchsweise Ueberprüfung dieses Systems eröffnet einen baldigen praktischen Einsatz.