

**Zeitschrift:** IABSE congress report = Rapport du congrès AIPC = IVBH  
Kongressbericht

**Band:** 10 (1976)

**Artikel:** Thermal effects of fires in buildings

**Autor:** Kawagoe, K. / Saito, H.

**DOI:** <https://doi.org/10.5169/seals-10387>

### **Nutzungsbedingungen**

Die ETH-Bibliothek ist die Anbieterin der digitalisierten Zeitschriften. Sie besitzt keine Urheberrechte an den Zeitschriften und ist nicht verantwortlich für deren Inhalte. Die Rechte liegen in der Regel bei den Herausgebern beziehungsweise den externen Rechteinhabern. [Siehe Rechtliche Hinweise.](#)

### **Conditions d'utilisation**

L'ETH Library est le fournisseur des revues numérisées. Elle ne détient aucun droit d'auteur sur les revues et n'est pas responsable de leur contenu. En règle générale, les droits sont détenus par les éditeurs ou les détenteurs de droits externes. [Voir Informations légales.](#)

### **Terms of use**

The ETH Library is the provider of the digitised journals. It does not own any copyrights to the journals and is not responsible for their content. The rights usually lie with the publishers or the external rights holders. [See Legal notice.](#)

**Download PDF:** 08.02.2025

**ETH-Bibliothek Zürich, E-Periodica, <https://www.e-periodica.ch>**

### IIIa

#### Thermal Effects of Fires in Buildings

Effets thermiques des incendies dans les bâtiments.

Thermische Auswirkungen bei Bauwerkbränden

**K. KAWAGOE**

Professor

Science University of Tokyo

Noda City, Japan

**H. SAITO**

Professor

Chiba University

Chiba City, Japan

#### Fire load

The large building should be made as the fire resisting structure. The practical new design method for the fire resisting structures ought to be established from the engineering point of view - the conventional design has been based simply on the standard fire tests.

We should know severity of fire in compartment in the case of the fire resisting design.

The most important factor to control severity of fire is the amount of combustible materials in the compartment. Therefore, it is necessary to estimate the amount of combustible materials in the compartment to be designed.

Combustibles inside building can be divided into that of fixed combustibles such as beds of wall, ceiling, floor, partition equipment etc. and lining materials, fittings, fixed furnitures, and that of loaded combustibles such as furnitures, books, clothes and other stored materials.

Since combustible materials in the room consists of various kinds of materials of different calorific value at combustion, the amount of combustible materials expressed in terms of the weight of wood that would produce by combustion heat equal to the heat content of the materials. this is the older definition of fire load.

Now, the heat content of combustible materials per unit floor area of fire compartment is called the fire load density, which is a basic element for analysis of fire severity.

$$q = \frac{\sum(G_i \cdot H_i)}{A} = \frac{\sum Q_i}{A}$$

where, q : fire load density (Mcal/m<sup>2</sup>)

G<sub>i</sub> : weight of combustible materials (Kg)

H<sub>i</sub> : unit calorific value of combustible materials (Mcal/Kg)

A : floor area of fire compartment (m<sup>2</sup>)

$\Sigma Q_i$  : total heat content of combustible materials in fire compartment (Mcal)

Actual conditions of fire load have not yet been understood correctly. It is presumed that the amount of fire loads have greatly decreased by use of steel furnitures with a latest change in living mode. For this reason, several countries are trying to investigate into actual conditions of amount of combustible materials to promote rational design of fire resisting structures. Since the amount of fire loads, depends on living mode, it seems to be necessary to perform investigations on actual conditions of fire load in each countries independently.

The amount of loaded combustible materials in modern office buildings of Japan is shown in Fig. 1.

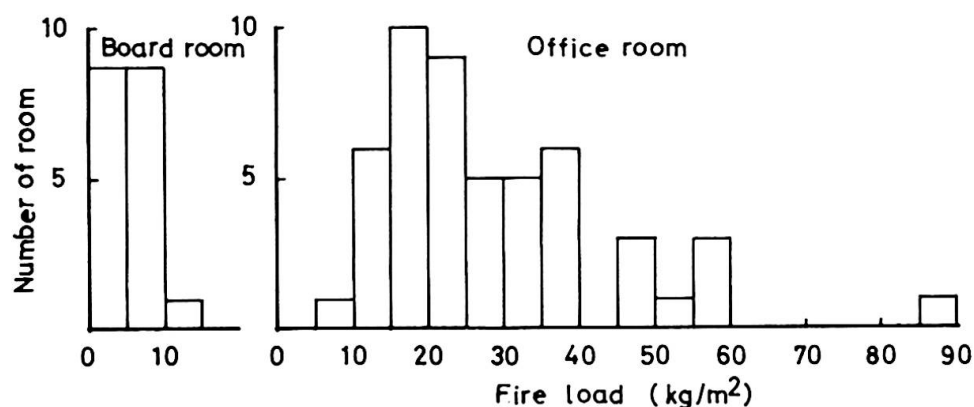

Figure 1. Distribution of fire load in room of modern office buildings.

#### Temperature History

The temperature history during a fire is illustrated in Fig. 2. The period A-B is the growth period which is quite long or short duration depended on a fire origin.

But a later stage of this period, development and spread of fire can be rapid as shown B-C, particularly when a room is lined with highly flammable materials or is filled with many furnitures made by plastics. When an enclosure becomes fully involved in fire and air temperatures have suddenly risen, flashover is said to have occurred. The period B-C is sometime said pre-flashover.

When flashover occurs smoke development and temperature rise in the compartment are so rapid that there is a life hazard inside building. We must consider the reduction of fire severity of flashover in designing buildings for life safety. Fire severity at flashover seems to depend on the size of fire origin, the area

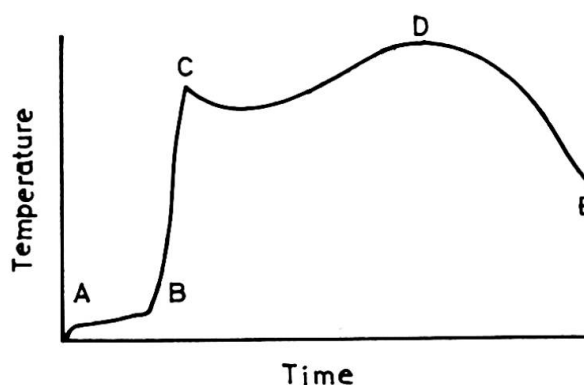

Figure 2. Air temperature history in a room.

of opening, and the quantity and quality of combustible materials including the internal linings, however, the theoretical approach to this phenomenon seems to be quite difficult. The second international co-operative study in working commission W-14 of CIB, which is to examine systematically the pre-flashover stage of fire, should yield very useful results.

As the mechanism of flashover is not clearly understood, the methods for testing combustibility of materials are quite different in many countries. Such lack of unity of testing method is rarely found in other fields. The working group of TC-92 of ISO, in which test method for fire are discussed, is expected to provide suitable fire test methods.

After flashover in a room the fully developed period C-D begins, in which period nearly steady state can be continued, although the air temperature in a room gradually rises. After the most combustible materials is burnt out the temperature starts to fall and the decay period D-E begins.

The problem of predicting the behaviour of fully developed fires in compartments is central to the structural design of fire resistance requirements for buildings. In spite of a large number of important investigations, our present state of knowledge on the detail characteristics of compartment fires is far from satisfactory. Somewhat simplified, we considered that fully developed compartment fires could be divided in the two types of behaviour[1].

The first regime of behaviour was well known ventilation controlled fire and the second was fuel surface controlled one.

Recently a new study has proposed the third regime which is controlled by fuel porosity[2].

Rate of Burning

The rate of burning after flashover in a room with normal openings is approximately proportional to the volume of inflow air through the openings. From the theory of ventilation based on buoyancy, and the basis of experiments, carried out in Denmark, Japan, Sweden, UK, USA and USSR, the following relation has been obtained[3,4]

$$R = (5.5 \sim 6.0) A \sqrt{H} \dots\dots\dots (1)$$

- where R : rate of burning (kg/min)
- A : opening area (m<sup>2</sup>)
- H : opening height (m).

This relation yields results approximately in agreement with experiments of fire in compartment with normal openings as shown in Fig.3 [5].

Alternatively, Eq(1) can be given in the following dimensionless form

$$R/\phi = 0.0236 \dots\dots\dots (2)$$

where  $\phi$  is a ventilation parameter of the same dimensions as the rate of burning R and defined by the ratio

$$\phi = \rho_a \sqrt{g} A \sqrt{H} \dots\dots\dots (3)$$

$\rho_a$  is the density of air and g the acceleration due to gravity[5]. With  $\rho_a = 1.29 \text{ kg/m}^3$  and  $g = 9.8 \text{ m/sec}^2$ , Equation(2) corresponds to the value  $5.7 \text{ kg} \cdot \text{min}^{-1} \cdot \text{m}^{-5/2}$  of constant in Eq(1).

The experimental data, given in Fig. 3 are characterized by

a considerable scatter. In spite of this, different regimes are recognizable, viz. The ventilation controlled regime, marked by an inclined line, and the fuel bed controlled regime, marked by a horizontal line.

For ventilation controlled fires an accuracy is sufficient in most practical cases of a structural fire engineering design. For fuel bed controlled fires the present state of knowledge is too incomplete for enabling a satisfactory. It seems reasonable to base a structural fire engineering design on the assumption of the fire to be ventilation controlled which will be on the safety side in the most case.

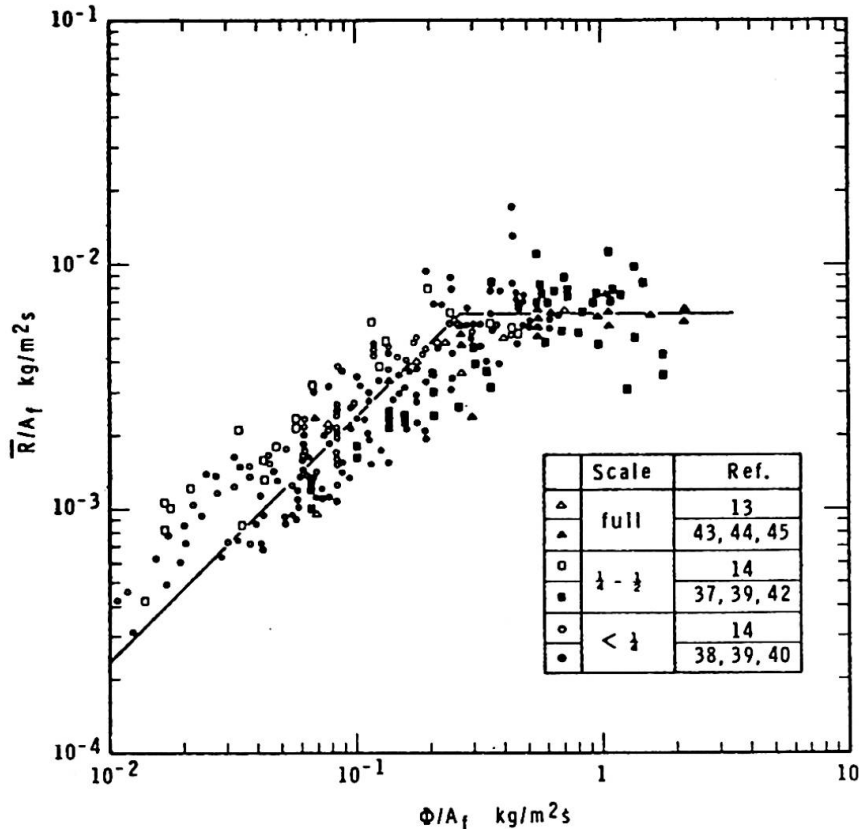

Figure 3. Correlation of experimental data concerning rate of burning in compartment fires.

Temperature-time Curve

When the rate of burning is known, the rate of heat release in a room can be estimated roughly, An equation of heat balance is as follows,

$$Q_H = Q_W + Q_B + Q_L + Q_R \dots\dots\dots (4)$$

- where
- $Q_H$  : the rate of heat release in the room
  - $Q_W$  : the rate of heat loss by heat transfer to the interior surfaces
  - $Q_B$  : the rate of heat loss by radiation through opening to the outer air
  - $Q_L$  : the rate of heat loss carried away with the spouting flame from opening
  - $Q_R$  : the rate of heat loss necessary for the air in the room warmed up to the fire temperature-ordinarily negligible.

By combining the heat conduction equations for the ceiling, walls and floor with the heat balance equation, it is possible to estimate a fire temperature vs. time curve in the room by numerical calculation[6,7].

The lower the thermal conductivity of the interior surface the higher the air temperature. If the thermal properties of all the interior surfaces and the height of the opening were assumed to be nearly the same for different rooms, the fire temperature would generally depend on the ratio between the area of the opening and the total surface area of the room.

After most of the fuel is burnt out, the rate of burning decreases but the remaining fuel on the floor continues to burn for a long time. For a full-scale fire test the temperature decreases at the rate of  $5\sim 10^{\circ}\text{C}/\text{min}$ . As the rate of burning is influenced by several factors in this decay period, it is difficult to determine the exact duration of fire. It is convenient in engineering point of view to determine the duration of the fire on the assumption that the rate of burning is always constant from beginning to end of a fire. This assumption errs on the side of safety.

If the height of the opening and the fire load per unit floor area were the same, the fire duration would depend on the ratio between the floor area and the opening area.

#### Relation With The Standard Fire Test

Although it is possible to estimate the temperature vs. time curve for a given room, the standard fire test is usually carried out by using a standard temperature-time curve. To find the relation between the standard and estimated curves, the area between the standard temperature-time curve and the line of the failure temperature for steel (which is around  $400^{\circ}\sim 500^{\circ}\text{C}$ ) can be taken as the criterion, because when a structural member is heated by both temperature vs. time curves, maximum temperature rises of steel in side structural member are almost same as shown in Fig. 4[6]. Thus we could deduce the equivalent fire duration corresponding to failure according to the standard fire test.

For a long time, fire duration has been considered to be proportional to fire load. In some country still this relation is the basic philosophy of the structural design of fire resistance requirements although a lot of correction factors is introduced in the fire load.

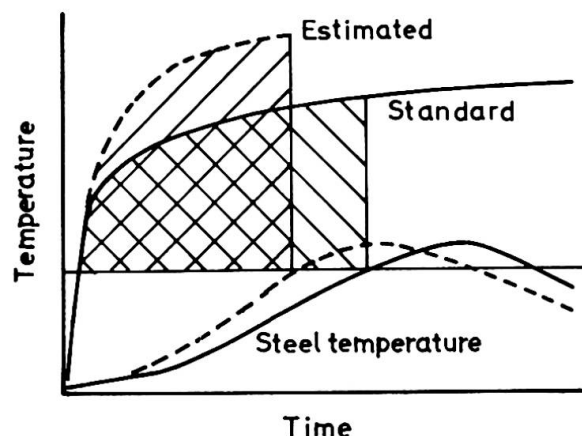

Figure 4. Equivalent standard fire test time.

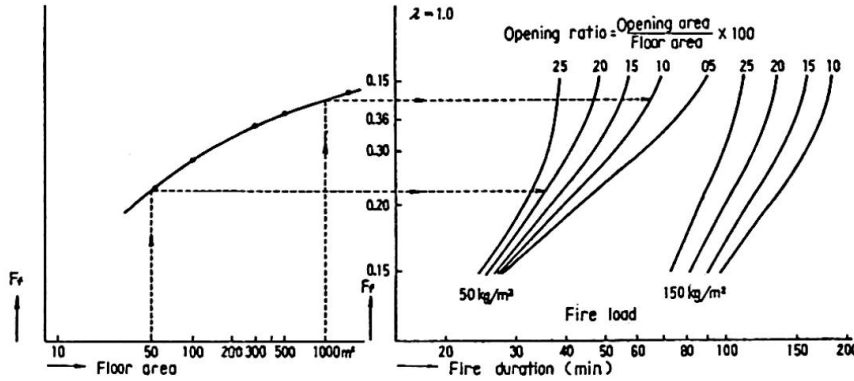

Figure 5. Relationship between fire duration, opening ratio and floor area (assumed that the ceiling height is 3.5 m)

Fig. 5[8] shows the relations between fire duration, opening ratio (area of opening/floor area) and floor area. We find that the fire duration is influenced by the floor area as well as the opening ratio. The larger the floor area of a compartment, the higher becomes the requirement for fire resistance under the same fire load.

Although at this time there are still many unknown variables it would be useful to establish a method for obtaining a temperature-time curve in a room for the structural design of fire-resistance even though it would be only a rough approximation.

Necessary Height of Spandrel

It is possible to predict flame height according to the following relation [9,10]

$$L/D \propto (R^2 / D^5)^{1/3} \dots\dots\dots (5)$$

We can apply this relation to the estimation of the spandrel height in order to prevent vertical fire spread from window to window. The flame emerging from a wide window as commonly found in modern buildings, clings to the wall surface over a long distance[11]. It is therefore necessary to break up the flame by making projections from the wall such as a balcony or some other device.

Estimation of Temperature Rise in the Structural Member

As mentioned before, it is not a reasonable requirement that the fire-resisting ability of each structural member should always be determined only by a standard fire test, even though it is required by building regulations. This limitation restricts building design in sometimes uneconomical and even dangerous ways.

For example, if steel columns have different thicknesses, even though they have the same outside dimensions and are protected with the same materials, their rates of temperature rise would be different because of their different heat capacities [12,13] as shown in Fig. 6. It is, therefore, wrong to prescribe the thickness of fire protection material without consideration of the heat capacity of steel.



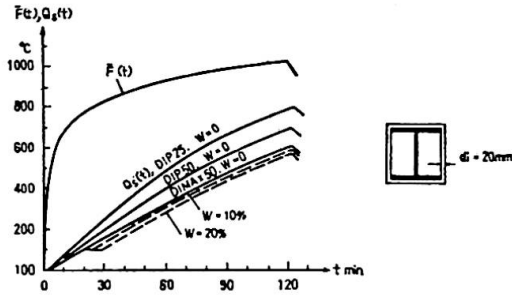

Figure 6. Temperature rise of steel column

It would be desirable to predict the temperature rise of the inside steel by means of heat flow calculations in each component of the structure.

The effect of big cracks or spalling of the cover should also be included in the heat flow calculations under some assumptions based on the fire tests. The thermal properties of building materials at high temperature are fairly well known, and heat flow calculations have been done in many countries. It must become more efficient and more reliable to calculate fire resistances for buildings rather than to determine them by fire tests. This would help to rationalize building design.

In line with the method of the estimation of temperature vs. time curve described previously, we can already calculate the heat conduction in structures surrounding on compartment.

### Mechanical Properties of Structural Steel at High Temperature

Some research results are available concerning mechanical properties of structural steel at high temperature. Depression of yield point of hot rolled steel at high temperature is shown in Fig. 7 and 8[14].

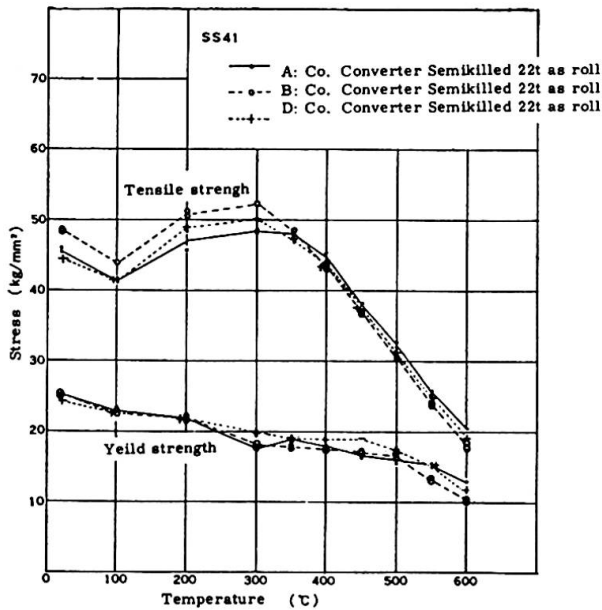

Fig. 7. High temperature properties of SS41

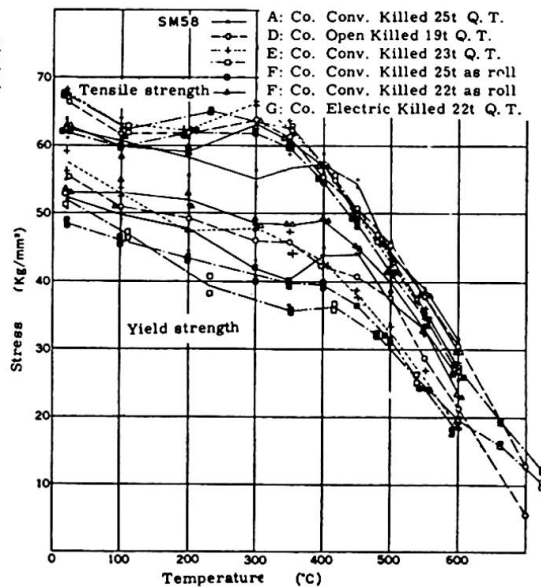

Fig. 8. High temperature properties of SM58



Rate of yield point depression shown here is the most important factor for fire resisting properties of steel structures. Supposing that a simple tensile member is heated when it has stress of 50% of yield point at a normal temperature by an action of tensile stress. Steel temperature naturally rises and yield point decreases. When yield point decreased as low as a half of that at a normal temperature, the member is destroyed by plastic deformation. The relation between this existing stress value and steel temperature at yield time is specified by yield point decrease ratios shown in these Figs. The yield point decrease ratio at high temperature depends on kind of steel.

Since mechanical properties at high temperatures and after heating depend on kinds of steel materials like this, full attention should be paid to mechanical properties of steel at high temperatures and after heating in evaluating fire resisting properties of steel structural members.

There has been almost no systematic research concerning high temperature strength of structural steel materials, however, a systematic experimental research on representative kinds of structural steel produced in Japan was carried out in recent years by the Society of Steel Construction of Japan, and systematic data were prepared.

#### Fire Resistance of Structures

The fire resistance of structural elements has, in the past, been determined only by the Standard Fire Test. Recently the study of structural behaviour at elevated temperatures has advanced remarkably. It is believed that the fire endurance of structural elements is influenced by the reduction of strength of materials and by the thermal stresses produced in the structure by restraint.

#### Steel Construction

When a simply supported flexural member of steel construction is heated from the lower side, its deflection increases in accordance with the differential thermal expansion between the upper and lower parts of the member, and with the reduction of the elasticity of steel. The collapse of the member occurs at the time when rise in temperature reduces the yield point to the working fibre stress of the member. The relation, shown in Fig. 9, is obtained from fire tests on beams [15]. A more precise analysis of the mechanism of failure has to be based on the creep behaviour of steel at elevated temperatures [16].

The allowable buckling stress of a column is reduced in accordance with the reduction in the values of the mechanical properties of steel caused by rise of temperature, as shown in Fig. 10 [17].

In discussing fire resisting properties of structural members principally bending and buckling strengths of simple support members have been discussed. However, fire resisting properties of structural members of real building are strongly influenced by restraining condition of ends of those members and show conditions considerably different from cases of simple support members.

When structural members were heated during fire, elongation of members caused by temperature increase inside section and deflection caused by unequal temperature distribution inside section generally appear. Although it poses no problem for member

without restraint of its ends since deformation appears as it is, ordinary structural member produce internal stress since deformation is restricted by end restraint. If this internal stress, that is to say, thermal stress by heating during fire, increases, members are destroyed and structural strength sharply decreases. The influence of this thermal stress on building structure is a problem to be considered carefully. For steel structural members, thermal stress by deflection in general needs not to be considered since temperature distribution inside section is comparatively uniform. However, thermal stress of steel structural members is very large when axial elongation is restricted at ends because of large change in member length.

From results of theoretical and experimental researches, it was clarified to be almost impossible to insure steel structural members with end restraint without damage during fire.

Increase ratios of thermal unit stress and thermal deformation greatly depend on the value of end restraint factor. Although an origin is different depending on the value of initial existing unit stress, thermal unit stress increases almost linearly with an increase of temperature, and when it reaches buckling unit stress at high temperature determined by slenderness ratio of member, it causes buckling destruction. Fig. 11 shows an example of experimental results [18]. For ordinary building structures, end restraint factor  $K$  is determined by load-deformation property of members giving restraint. Therefore, in the case that heated member is destroyed at a comparatively low temperature when  $K$  is large, members giving restraint do not suffer damage, on the other hand, in the case that heated member is not destroyed until it reaches a considerably high temperature when  $K$  is small, members giving restraint suffer forced deformation to a considerable degree. This can be shown as in Fig. 12.

In general, it can be considered that beam is heated while pillar gives restraint, therefore, if forced deformation such like outside thrusting of pillar is not prevented by strengthening end

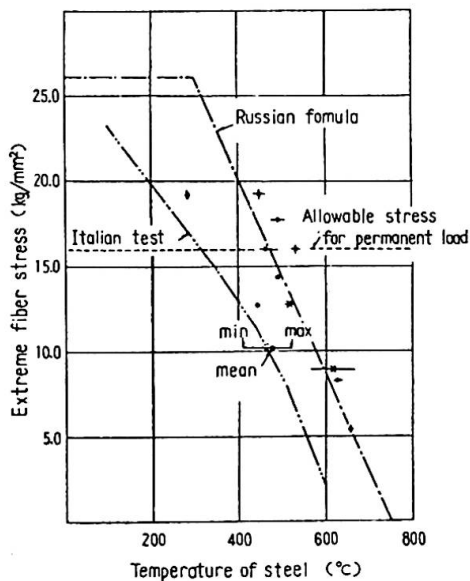

Figure 9. Relationship between working stress and temperature of steel at yielding failure

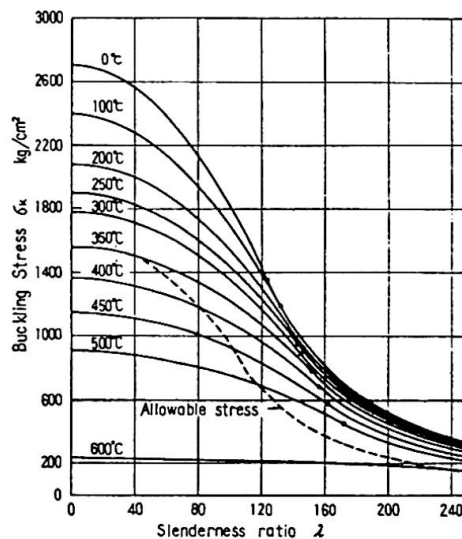

Figure 10. Buckling stress of steel column at elevated temperature

restraint degree against beam with enhancing rigidity of pillar, there is danger of collapse of the whole building. In other words, it is needed to try relaxation of thermal stress by partially destroying beams on purpose at an earlier time.

However, since multiple span structure is generally used and end restraint against central beams shows a very large value, central beam at first suffers partial buckling at a considerably low steel temperature during fire, and it is transferred to structure with a halved number of span. If partial destruction of beam develops by turns like this, forced deformation against pillar can be presumed to be not so large.

In the case that elongation restraint of end of member is acting on eccentrically, conditions are quite different from the case of central restraint. Test results of this case are shown in Fig. 13[18]. When bending moment by restraining force appeared with an increase of steel temperature reached a value of yield bending moment of member, increase of thermal unit stress stops. If steel temperature further increases, yield bending moment of member gradually decreases. In such a case, rapid destruction does not occur.

In ordinary steel structures, about 200°C in an average temperature of section of member is a critical temperature for partial destruction by thermal stress. Against this situation, it is necessary to take a measure to prevent partial destruction by designing sufficient fire covering or to loosen thermal stress of member relating with structural stability by partial destruction on purpose.

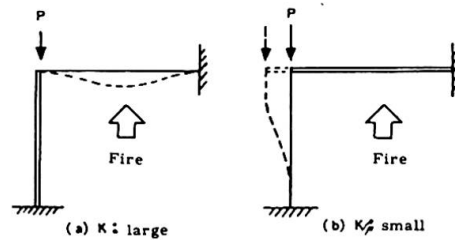

Fig. 12.

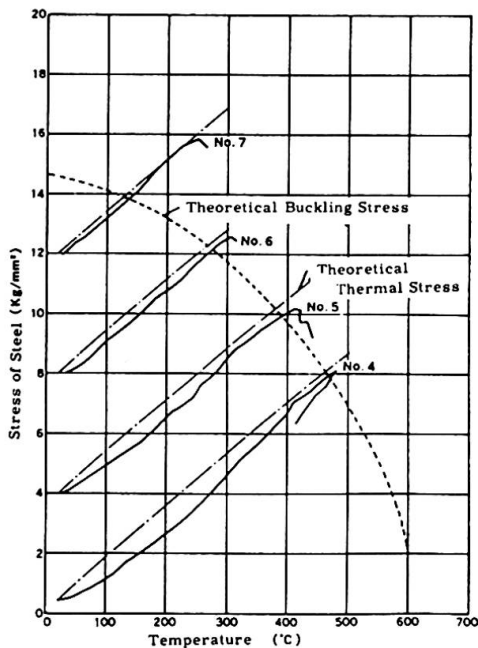

Fig. 11. Test results (central loading)

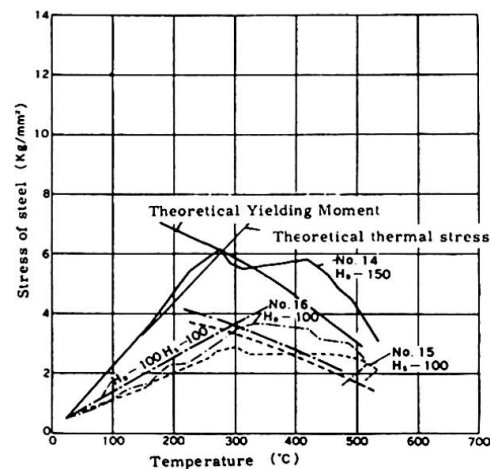

Fig. 13. Test result (Eccentric loading)

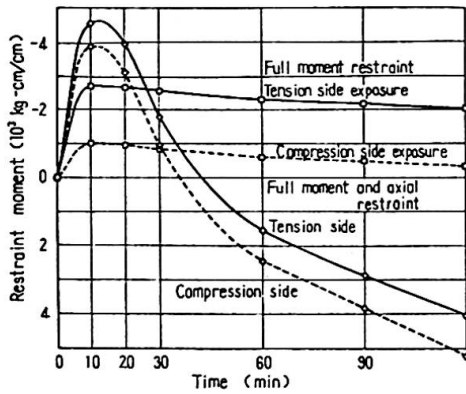

Figure 14. Restraint moment of reinforced concrete beam

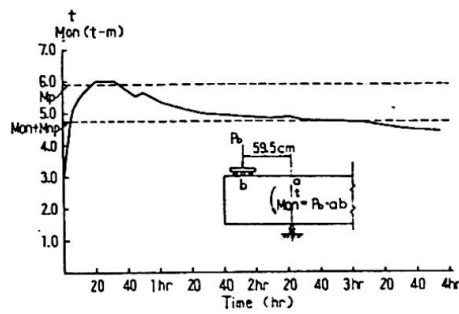

Figure 15. Restraint moment

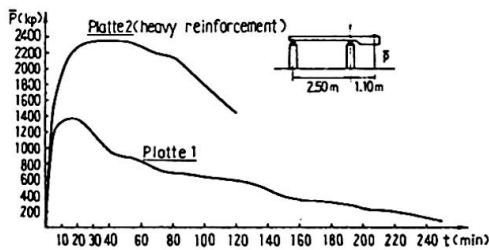

Figure 16. Continuous slab 1 and 2. Re-distribution of tension force P

## Reinforced Concrete

The structural behaviour of reinforced concrete members in fire is affected by the mechanical properties of the concrete and of the reinforcement at elevated temperatures.

It is possible to estimate the internal thermal stresses and the deflection of each member theoretically, by using data on the thermal expansion of the concrete and of the steel bar and on the reduction of their elasticities with temperature [19,22]. The time of collapse is determined either by the ultimate strength of the concrete or by the effect of the elevated temperature on the steel bar.

The structural behaviour of a beam restrained at the both ends is shown in Fig. 14, 15 and 16 [19-21].

In the case of prestressed concrete structures, the strength of steel at the elevated temperature is different from the usual steel bar and the initial stress of concrete is also higher than for ordinary reinforced concretes, but the structural behaviour of a member exposed to fire is essentially the same as for ordinary reinforced concrete members.

Some mechanical properties of concrete and steel bars at elevated temperatures, especially the stress strain curves, have been investigated experimentally by a number of laboratories.

## Spalling of Concrete

The explosive breaking off of pieces from concrete materials during fire exposure is known as spalling. Reinforced or prestressed concrete structure has explosively spalled in the early stage of fire. In general spalling reduces the fire resistance of a structure. Sometimes the concrete structure with thin thickness loses their function as the structural member by

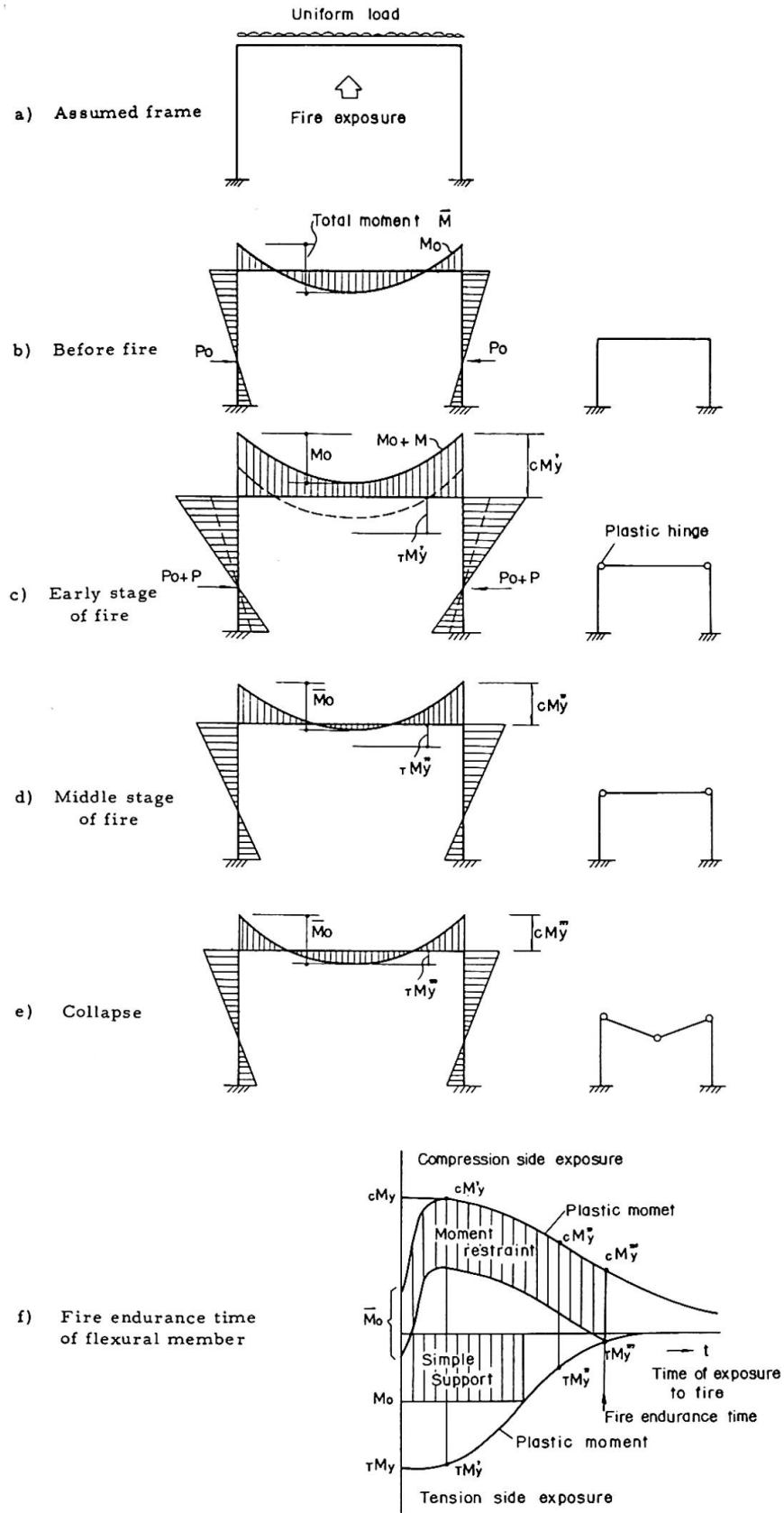

Fig. 17. Redistribution of moment and mechanism of collapse in building fire



the explosive spalling of concrete, while thick structural member does not cause structural failure except that part of the concrete surface falls to pieces by spalling. Therefore it becomes very difficult to protect a building from fire when concrete structures are used. Thus, the phenomenon of spalling of concrete structure under fire can be regarded considerably important among other happenings caused by fire.

At present, however, the cause for this explosive spalling of concrete when exposed to fire has not been thoroughly explained. There are numerous factors which influence spalling. From experimental and theoretical data it can be derived that the most common types of spalling are spalling mainly due to thermal stress of a concrete near the surface [23-25], and spalling mainly due to formation of steam at high pressure in the concrete [26].

### Effect of Restraint

In the case of general, structural member is fixed to other members at the end. Therefore, it can be considered as having an elastic restraint against expansion and rotation. Suppose the beam in Fig. 17-a, which receives uniform load, is heated at the bottom. Bending moment of each member distributes as shown in Fig. 17-b. When the beam is heated, distribution of bending moment moves upwards in parallel because of axial and moment restraint as shown in Fig. 17-c. If stiffness of restraint member is large, this change grows large.

Moreover, magnitude of end moment ( $M+M_0$ ) differs by reinforcement at the end of beam and it grows up to the value of bending moment  $cM'_y$  at which end section of beam being heated on the compression side causes failure. Since value of  $cM'_y$  decreases with accordance of the passage of time, ( $M+M_0$ ) at the end, lowers along with the passage of heating time after it reaches  $cM'_y$  and then becomes  $cM''_y$  and  $cM'''_y$ . Because total moment by dead load and external load of beam is definite, moment in the center of span increases by gradually. When moment in the center of span grows as large as the value of bending moment  $\dagger M''_y$  at which section heated on the tension side causes failure, beam as a whole makes sudden transformation to result in collapse, as shown in Fig. 17-e.

### References

1. THOMAS, P. H., HESELDEN, A.J.M., LAW, M., (Fully- Developed Compartment Fires.) Fire Research Technical Paper No.18, H.M.S.O.
2. THOMAS, P. H., NILSSON, (Fully Developed Compartment Fires) Fire Research Note No.979, 1973
3. SEKINE, T., Report of the Building Research Institute of Japan No.29, 1959
4. HESELDEN, A.J.M., THOMAS, P.H., LAW, M., (Burning Rate of Ventilation Controlled Fires in Compartments.) Fire Technology Vol.6, No.2, 1970
5. HARMATHY, T.Z., (A New Look at Compartment Fires. Part I.II.) Fire Technology, Vol.8, No.3, No.4, 1972
6. KAWAGOE, K., SEKINE, T., (Estimation of Fire Temperature-time Curve in Rooms.) Building Research Institute of Japan, Research Paper No.11, 1963, No.29, 1967

7. ÖDEEN, K., (Theoretical Study of Fire Characteristics in Enclosed Space.) Royal Institute of Technology, Bulletin No.10, 1963
8. KAWAGOE, K., Fire and Modern Building Design. Proceedings of the Fourth CIB Congress, 1968
9. FIRE RESEARCH. H.M.S.O. 1959
10. YOKOI, S., Building Research Institute of Japan, Occasional Report No.12 1963
11. YOKOI, S., Report of the Building Research Institute of Japan, No.34, 1960
12. WAKAMATSU, T., Building Research Institute of Japan, Research Paper No.54, 1972
13. PETERSSON, O., ACTA Polytechnica Scandinavica, Civil Engineering and Building Construction Series, No.33, 1965
14. HIGH TEMPERATURE STRENGTH GROUP, (Mechanical Properties of Structural Steel at High Temperature and After Heating.) JSSC Vol.4, No.33, 1968, Vol.5, No.45, 1969
15. SAITO, H., Building Research Institute of Japan, Research Paper No.31, 1968
16. HARMATHY, T. Z., Fire Test Method, Restrain and Smoke, 1966, ASTM, STP 422
17. SAITO, H., Trans. of the Architectural Institute of Japan No.76, 1962
18. SAITO, H., Bulletin of the Fire Prevention Society of Japan, 15, No.1, 1966
19. SAITO, H., Building Research Institute of Japan, Research Paper No.32, 1968
20. YAKOVLEV, A.I., Teoriya Rascheta I Konstruirovaniya Zhelezo Betonnykh Konstruktsiy, Moscow, 1958
21. EHM. H, VON POSTEL.R, Feuerwiderstandsfähigkeit von Spann-beton, Bauverlag GmbH. Wiesbaden 1966
22. BECKER, J., BRESLER, B., (A Computer Program for the Fire Response of Structures-Reinforced Concrete Frames) Report No. UCB FRG 74-3 1974
23. CARLSON, C. C., SELVAGGIO, S. L., GUSTAFERRO, A. H., Feuerwiderstandsfähigkeit von Spann-beton, Bauverlag GmbH. Wiesbaden, 1966
24. KORDINA, K., Feuerwiderstandsfähigkeit von Spann-beton, Bauverlag GmbH. Wiesbaden, 1966
25. SAITO, H., Feuerwiderstandsfähigkeit von Spann-beton, Bauverlag GmbH. Wiesbaden, 1966
26. SHORTER, G. W., HARMATHY, T. Z., (Discussion on the Fire-resistance of Prestressed Concrete Beams) Proceedings, Institute of Civil Engrs., 20, 1961

#### SUMMARY

The inadequacy of traditional design philosophy for fire protection in accordance only with a building code is discussed.

The characteristics of compartment fires are reviewed. And the fire endurance of structural elements is influenced by the reduction of strength of materials and by the thermal stresses produced in the structure by restraint. Therefore, the influence of the thermal stress is a problem to be considered carefully.

A new fire engineering design approach is considered.



## RESUME

Les dispositions constructives traditionnelles pour la protection contre l'incendie ne sont pas satisfaisantes lorsqu'elles sont basées uniquement sur un règlement de construction.

Les caractéristiques des incendies sont passées en revue. La résistance à l'incendie des éléments d'une structure dépend de la résistance des matériaux et des efforts thermiques produits dans la structure. L'influence des efforts thermiques doit être étudiée sérieusement.

Une nouvelle méthode de dimensionnement au feu est proposée.

## ZUSAMMENFASSUNG

Bezüglich des Brandschutzes unterstreichen die Autoren die Unzulänglichkeit einer traditionellen Entwurfskonzeption, welche nur auf Baureglementen basiert.

Die charakteristischen Eigenschaften von Feuereinwirkungen in Brandabschnitten werden untersucht. Der Feuerwiderstand von Tragelementen wird durch die Abnahme der Materialfestigkeit und durch die thermischen Zwängungsspannungen beeinflusst. Diese Zwängungsspannungen verdienen daher besondere Aufmerksamkeit.

Es wird ein neues ingenieurmässiges Entwurfsverfahren für den Brandschutz dargestellt.

Leere Seite  
Blank page  
Page vide