

# Interactive computer graphics in structural engineering

Autor(en): **Greenberg, D.P. / Abel, J.F. / McGuire, W.**

Objektyp: **Article**

Zeitschrift: **IABSE congress report = Rapport du congrès AIPC = IVBH  
Kongressbericht**

Band (Jahr): **11 (1980)**

PDF erstellt am: **21.07.2024**

Persistenter Link: <https://doi.org/10.5169/seals-11325>

## **Nutzungsbedingungen**

Die ETH-Bibliothek ist Anbieterin der digitalisierten Zeitschriften. Sie besitzt keine Urheberrechte an den Inhalten der Zeitschriften. Die Rechte liegen in der Regel bei den Herausgebern.

Die auf der Plattform e-periodica veröffentlichten Dokumente stehen für nicht-kommerzielle Zwecke in Lehre und Forschung sowie für die private Nutzung frei zur Verfügung. Einzelne Dateien oder Ausdrucke aus diesem Angebot können zusammen mit diesen Nutzungsbedingungen und den korrekten Herkunftsbezeichnungen weitergegeben werden.

Das Veröffentlichen von Bildern in Print- und Online-Publikationen ist nur mit vorheriger Genehmigung der Rechteinhaber erlaubt. Die systematische Speicherung von Teilen des elektronischen Angebots auf anderen Servern bedarf ebenfalls des schriftlichen Einverständnisses der Rechteinhaber.

## **Haftungsausschluss**

Alle Angaben erfolgen ohne Gewähr für Vollständigkeit oder Richtigkeit. Es wird keine Haftung übernommen für Schäden durch die Verwendung von Informationen aus diesem Online-Angebot oder durch das Fehlen von Informationen. Dies gilt auch für Inhalte Dritter, die über dieses Angebot zugänglich sind.



## **Interactive Computer Graphics in Structural Engineering**

Représentation graphique interactive dans les projets de génie civil

Interaktive graphische Darstellungsmethoden im Bauingenieurwesen und beim Entwurf

### **D.P. GREENBERG**

Professor, Director, Program of Computer Graphics  
Cornell University  
Ithaca, NY, USA

### **J.F. ABEL**

Associate Professor of Structural Engineering  
Cornell University  
Ithaca, NY, USA

### **W. McGUIRE**

Professor of Structural Engineering  
Cornell University  
Ithaca, NY, USA

## **SUMMARY**

The presentation graphically depicts the advantages of the uses of interactive graphics in structural engineering and design. Full color images of numerous projects conducted at Cornell University's Program of Computer Graphics were shown. These included two and three dimensional frames, two dimensional plates, shell surfaces, and cable and membrane structures. Results of nonlinear geometric and material behaviour, as well as dynamic analyses were illustrated. Color was used to represent stress levels and also provide realistic simulations of three-dimensional structures.

## **RESUME**

L'article représente les avantages de l'emploi de la représentation graphique interactive dans les projets de génie civil. Quelques projets réalisés à l'Université Cornell sont illustrés. Il s'agit de cadres bi- et tridimensionnels, de plaques, coques, structures en câbles et membranes. Le comportement non linéaire du matériau et les études dynamiques sont illustrés. La couleur est utilisée pour représenter des états de contraintes et permettre la simulation réaliste de structures tridimensionnelles.

## **ZUSAMMENFASSUNG**

Der Artikel enthält eine Übersicht über die Vorteile der Verwendung interaktiver graphischer Darstellungsmethoden im konstruktiven Ingenieurbau und beim Entwurf. Farbbilder von zahlreichen an der Cornell Universität ausgeführten Objekten werden gezeigt. Diese schliessen zwei- und dreidimensionale Rahmen, Platten, Schalen, Kabel- und Membran-Tragwerke ein. Resultate von nonlinearem geometrischem und materiellem Verhalten sowie dynamische Analysen werden beschrieben. Farbe wurde verwendet, um Spannungsintensität anzuzeigen und um realistische Nachahmungen von dreidimensionalen Tragwerken zu verschaffen.



## 1. INTRODUCTION

During the past two decades, a number of important technological advances have occurred in both the computer industry and structural engineering. These advances have created an environment conducive to the marriage of computer graphics and structural design.

- A. The cost of computing is decreasing exponentially.
- B. Analytical techniques, such as matrix analysis or finite element analysis, have been refined.
- C. The complexity and detail of problems we are now able to analyze and examine are rapidly increasing. Large scale problems with many thousand unknowns are now commonly investigated.

Unfortunately, the time required to accurately define the information necessary for a computer analysis is excessive. It may take many man-weeks to properly prepare this input information. Furthermore, the cost of this labor, particularly skilled engineering labor, is expensive. Perhaps 85% of the typical cost of a finite element analysis may be in the input task.

If this situation is unacceptable, an even worse problem exists in the interpretation of the results. One sometimes spends many hours searching through pages of computer output trying to understand and interpret the analysis.

All of this leads to the conclusion that another method for communication between man and the MACHINE is necessary. Furthermore, it is obvious that this method should be graphical.

We live in a visual world. Our ability to comprehend graphical information far exceeds our ability to understand verbal or numerical information. The largest percent of our informational intake is through our eyes. In short, "a picture is worth a 1,024 words!"

Fortunately, advances in the computer graphics industry now make it possible to communicate graphically, both for problem descriptions and the display of results. Digitizing tablets with a stylus for user interaction are common. Hardware is available for dynamic black and white displays or high resolution color displays. Through software, we can create realistic images of things which do not exist.

It is our belief that the future of design engineering will rely on this technology and, specifically, on the uses of INTERACTIVE COMPUTER GRAPHICS.

It is important to emphasize the meaning of the word "interactive" in computer graphics. When graphical operations and commands are specified, it is necessary to have response times fast enough to provide a continuous communication dialogue with the user. For three-dimensional investigations or dynamic problems, continuous motion displays are necessary. In order to fully understand complex geometries, one would like to simulate walking around the structure, like taking a model in your hands and turning it around to examine it. This requires the rapid generation of perspective images, maybe 30 or 40 times per second, in order to imply motion. Color is also useful, not only to provide a realistic three-dimensional image, but to display results.

These concepts will be illustrated by showing you the results of several research projects which have been conducted at Cornell's Program of Computer



## Graphics.

In 1974, Cornell University established an interdisciplinary Center of Computer Graphics dedicated to the development of graphics techniques and the use of these techniques in research applications. The center now is one of the most advanced computer graphics laboratories in the world and has obtained a substantial amount of research funding during the past six years. In addition to the basic computer graphics research, investigations have been conducted in such application areas as water resources planning, medicine, architecture, and cartoon animation. We are currently creating a new instructional facility in Computer-Aided Design. The ultimate mission of this center will be to guarantee all 2,000 undergraduate engineering students at least one course on this interactive graphics system. A diagram of the laboratory is shown in Figure 1.

In the remaining time I wish to briefly show the results of some of our specific efforts in structural engineering. The work is not my own, but represents the contribution of my co-authors, Professor John Abel and Professor Bill McGuire, as well as the efforts of a large number of graduate students over the past five years.

I apologize for the medium of presentation as static images are obviously not the best way to illustrate interactive graphics. However, without the use of video projection equipment or constrained by the inability to transport my laboratory to the conference, these slides will have to suffice.

## 2. VISUAL PRESENTATION OF SLIDES (Examples shown in Figures 2-9)

## 3. CONCLUSION

It should be obvious that INTERACTIVE Computer Graphics is an important tool demanding further refinement. It may not be obvious that it is much more than a tool. The advent of the electronic computer did not result in additions to the laws of mechanics, but it has revolutionized structural and geotechnical engineering. The engineer who truly understands the methods developed in response to the computer's capabilities has a broader insight into system behavior than his forebearer whose perceptions were restricted by the limited power of older methods. Interactive computer graphics should have a similar impact on the profession.

In conclusion, let me state that INTERACTIVE Computer Graphics offers the best promise for inserting the designers ability into the iterative design and analysis feedback loop. More importantly, it will offer the opportunities for new insights, new understandings, and new design concepts simply because it reduces the barriers of communication and thus will allow man to more effectively use the machine.

I hope this brief talk has shown that the technology is here, and is waiting to be accepted. To quote Ralph Waldo Emerson, "An idea whose time has come is the most potent of all natural forces".

Thank you.

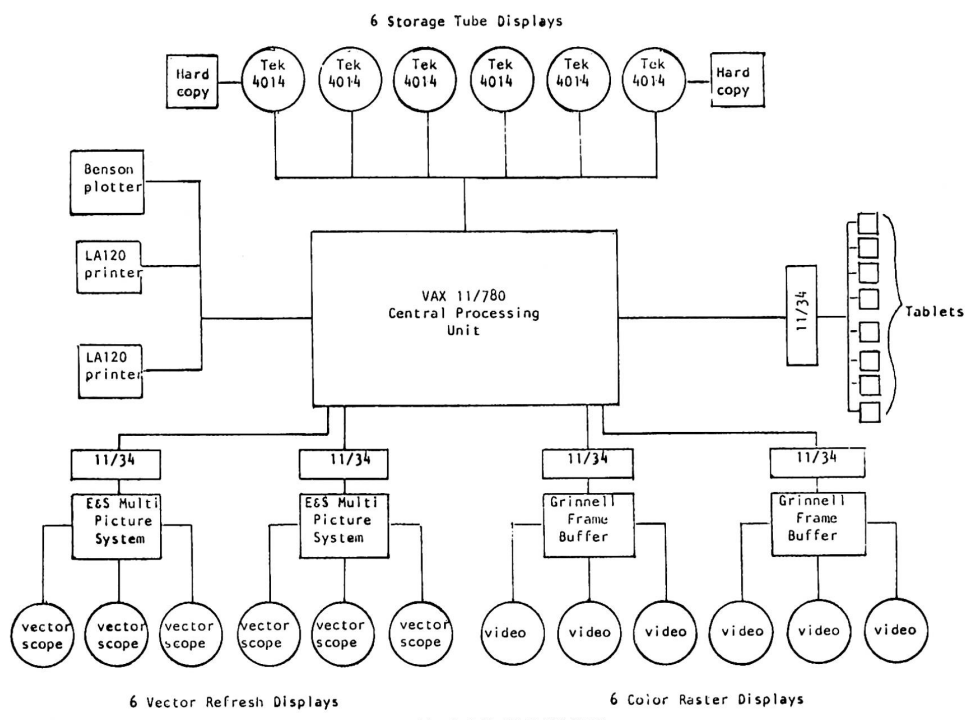

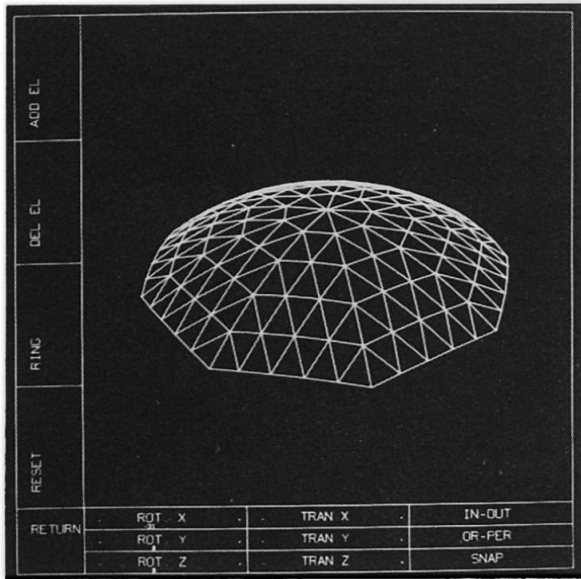

Fig. 2

Example of a varax dome structures interactively modeled on a refresh vector display.

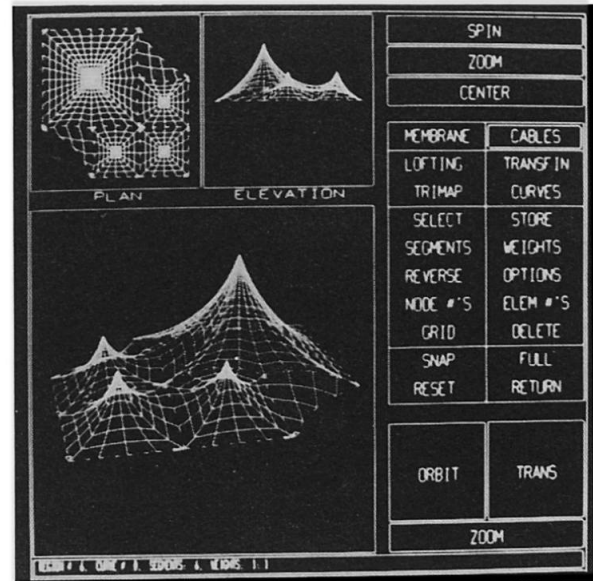

Fig. 3

Example of a cable or membrane structure.

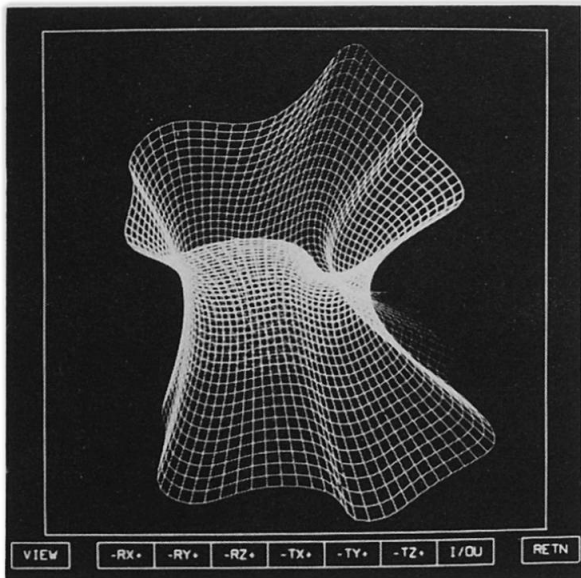

Fig. 4

Example of an arbitrary surface interactively modeled using B-splines for the sectional contours and lofted with cardinal splines.

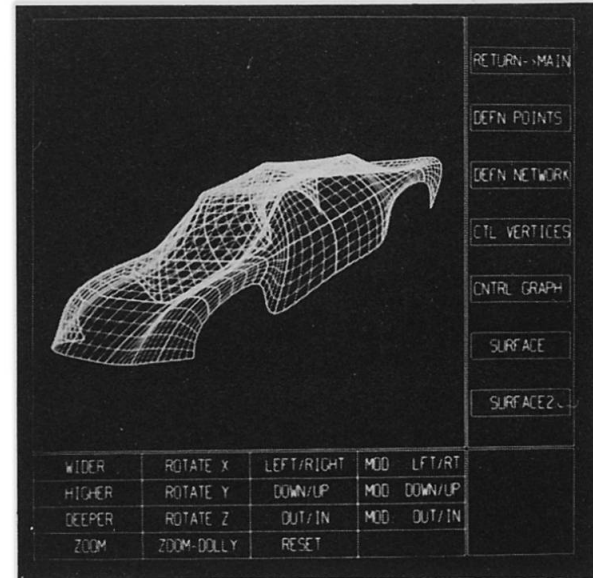

Fig. 5

A bivariate B-spline surface interactively modeled by manipulating the control graph.

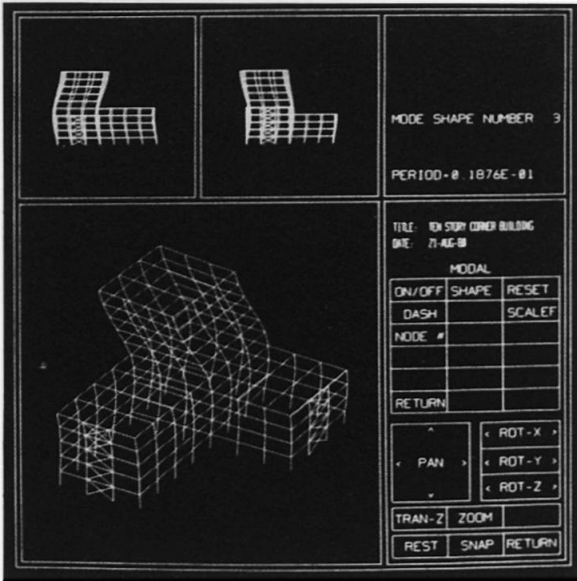

Fig. 6.

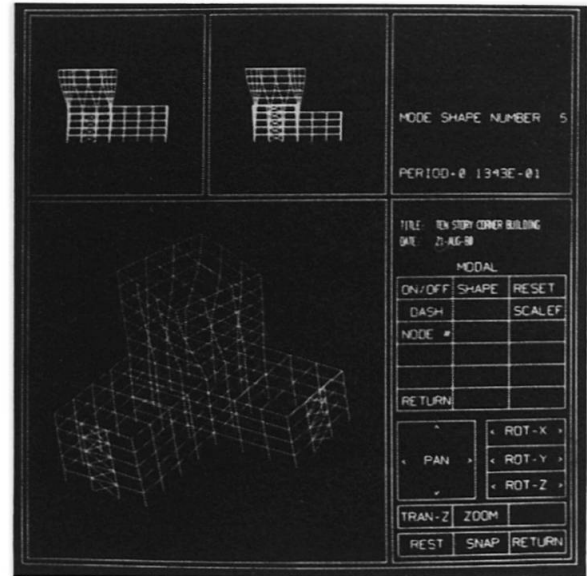

Fig. 7

Interactively modeled ten-story building frame subjected to dynamic loads. Figures 6 & 7 indicate two of the modal shapes displayed on a refresh vector display.

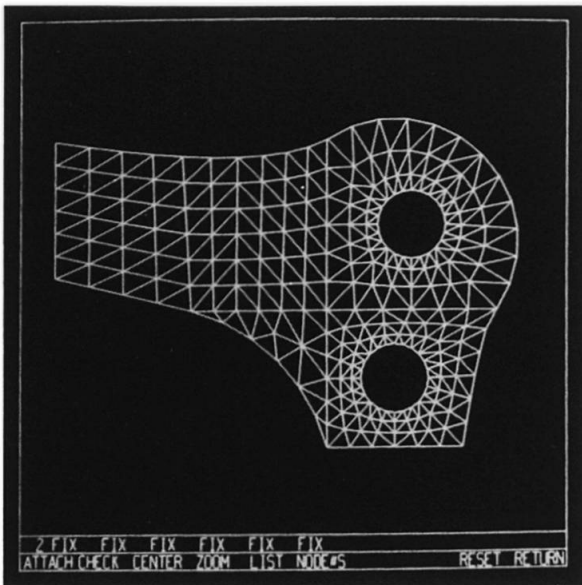

Fig. 8

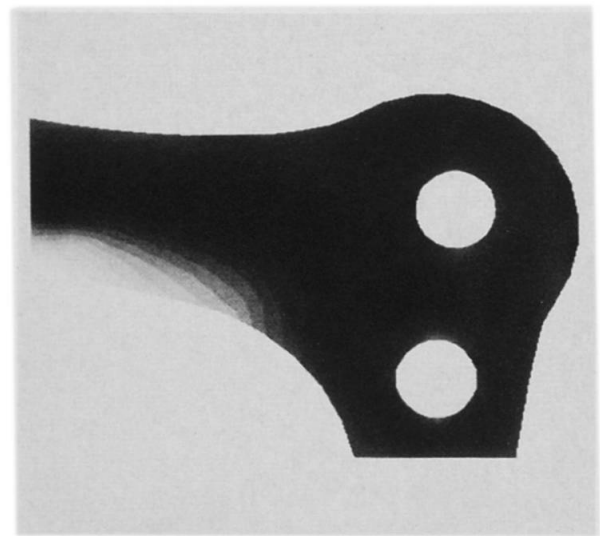

Fig. 9

Display of a completed finite element mesh of a bracket. The object was interactively meshed with a general two dimensional graphic finite element preprocessor utilizing discrete transfinite mapping. The shaded picture is a grey scale rendition of a color raster display of the stress levels using the stress analysis postprocessor.