

## II. Modern timber structures

Objekttyp: **Group**

Zeitschrift: **IABSE congress report = Rapport du congrès AIPC = IVBH  
Kongressbericht**

Band (Jahr): **11 (1980)**

PDF erstellt am: **21.07.2024**

### **Nutzungsbedingungen**

Die ETH-Bibliothek ist Anbieterin der digitalisierten Zeitschriften. Sie besitzt keine Urheberrechte an den Inhalten der Zeitschriften. Die Rechte liegen in der Regel bei den Herausgebern.

Die auf der Plattform e-periodica veröffentlichten Dokumente stehen für nicht-kommerzielle Zwecke in Lehre und Forschung sowie für die private Nutzung frei zur Verfügung. Einzelne Dateien oder Ausdrucke aus diesem Angebot können zusammen mit diesen Nutzungsbedingungen und den korrekten Herkunftsbezeichnungen weitergegeben werden.

Das Veröffentlichen von Bildern in Print- und Online-Publikationen ist nur mit vorheriger Genehmigung der Rechteinhaber erlaubt. Die systematische Speicherung von Teilen des elektronischen Angebots auf anderen Servern bedarf ebenfalls des schriftlichen Einverständnisses der Rechteinhaber.

### **Haftungsausschluss**

Alle Angaben erfolgen ohne Gewähr für Vollständigkeit oder Richtigkeit. Es wird keine Haftung übernommen für Schäden durch die Verwendung von Informationen aus diesem Online-Angebot oder durch das Fehlen von Informationen. Dies gilt auch für Inhalte Dritter, die über dieses Angebot zugänglich sind.



---

## **WORKING SESSION**

### **II**

#### **Modern Timber Structures**

#### **Structures modernes en bois**

#### **Moderner Ingenieurholzbau**

Co-chairmen: H. Hartl, Austria  
R. Greisch, Belgium

Introductory Papers: "Entwicklungen im Anwendungsbereich des Baustoffes Holz"  
K. Möhler, FRG  
"Baustoff Holz – Erkenntnisse und Entwicklungen im  
technologischen Bereich und in den Verbindungen"  
E. Gehri, Switzerland  
"Progress in Codes and Standards in Timber Construction"  
J.G. Sunley, Great Britain

Coordinator: E. Gehri, Switzerland



Leere Seite  
Blank page  
Page vide



## Neue Entwicklungen im Ingenieurholzbau

Recent Developments in Timber Construction

Développement de la construction en bois

### KARL MÖHLER

Professor für Ingenieurholzbau und Baukonstruktionen  
Universität (TH) Karlsruhe  
Karlsruhe, BRD

### ZUSAMMENFASSUNG

Neue Holzbaustoffe, neue Verbindungsmittel und Verbindungstechniken, sowie besondere Konstruktionsformen haben in den letzten Jahren die Errichtung spektakulärer, weitgespannter Hoch- und Brückenbauten sowie Sonderbauwerke verschiedenster Art in Holzbauweise ermöglicht. Die Holzbauforschung hat dank praxisnaher Versuche und Untersuchungen die Grundlagen erarbeitet, um das Trag- und Verformungsverhalten der neu entwickelten Tragwerksformen weitgehend erfassen und eine sichere Bemessung der Holzbauteile gewährleisten zu können. Auf die Notwendigkeit die neuen Berechnungsverfahren in die Holzbaunormen aufzunehmen wird hingewiesen.

### SUMMARY

In the last years new wood based materials, new connectors and connecting techniques as well as special constructional forms made possible spectacular, longspanned roofs and bridges in timber construction as also special buildings of different kind in timber construction. Through testing and timber research, knowledge has been gained over the strength and deformation behaviour of the new developed structural forms and therefore allow a safe design of timber elements. The need of codifying the new design methods is pointed out.

### RESUME

Le développement récent de la construction en bois se manifeste par de nouveaux matériaux, de nouvelles techniques d'attache et de nouvelles formes porteuses, et se concrétise par toutes sortes d'audacieuses constructions à longue portée, dans le domaine des ponts, des couvertures et des bâtiments spéciaux. En s'appuyant sur de nombreux résultats d'essais et de calcul, le chercheur a fourni au praticien les bases permettant un calcul fiable du comportement de ces nouvelles structures et conduisant à un dimensionnement sûr de leurs éléments en bois. L'auteur fait ressortir la nécessité d'inclure dans les normes ces nouvelles méthodes de calcul.



## 1. EINLEITUNG

Der Ingenieurholzbau als Teilgebiet des konstruktiven Ingenieurbauwes hat in den beiden letzten Jahrzehnten eine zunehmende ingenieurmäßige Entwicklung erfahren, die es gerechtfertigt erscheinen läßt, das Thema "Moderner Ingenieurholzbau" zum 1. Male als Hauptthema eines IVBH-Kongresses zu behandeln. Diese Entwicklung ist nicht nur durch die Errichtung spektakulärer, weitgespannter Hoch- und Brückenbauten, schwer belastbarer hölzerner Lehrgerüste, Maste und Sonderbauwerke verschiedenster Art gekennzeichnet, sondern allgemein durch die Schaffung und Anwendung tragender Holzwerkstoffe, neuer Verbindungstechniken und besonderer Konstruktionsformen. Hierzu kommen Verbesserungen des baulichen und chemischen Holzschutzes und das durch wirklichkeitsnahe Versuche nachgewiesene günstige Brandverhalten großer Holzquerschnitte, auch bei Anwendung stählerner Verbindungsstrukturen. Gleichzeitig hat die Holzbauforschung in stetem Gedankenaustausch mit der Praxis die Grundlagen für Bemessung und Ausführung erarbeitet, indem sie das Verformungs- und Festigkeitsverhalten der zur Anwendung kommenden Werkstoffe, neuen Tragwerksformen und Verbindungsstrukturen untersucht hat. Tragsicherheit und erforderliche Gebrauchsfähigkeit der Ingenieurholzkonstruktionen können damit nach den Gesetzmäßigkeiten der Baustatik und Festigkeitslehre nachgewiesen werden. Dabei ist zu berücksichtigen, daß für den natürlich gewachsenen anisotropen und hygroskopischen Baustoff Holz und weitgehend auch für die Holzwerkstoffe andere Gesetzmäßigkeiten gelten wie für die homogenen Baustoffe, so daß an den Holzbauingenieur besondere Anforderungen bezüglich Baustoffkenntnis und konstruktivem Verständnis gestellt werden müssen.

Entsprechend den Entwicklungen des Ingenieurholzbauwes wurden die Berechnungsverfahren laufend erweitert und für die neuartigen Konstruktionsformen bereit gestellt. Gleichzeitig sollten die Holzbaunormen dem neuesten Stand angepaßt werden. Diese Arbeiten sind nicht nur in verschiedenen Ländern im Gange, sondern es wurde auch bereits vor einigen Jahren im Rahmen der ISO die Normung von Berechnung und Ausführung von Holzbauwerken nach einheitlichen Grundlagen in Angriff genommen (siehe J.G. Sunley, Vorbericht).

## 2. NEUE HOLZBAUSTOFFE

Während Vollholz als Rundholz, Kantholz, Bohle oder Brett nur in beschränkten Abmessungen zur Verfügung steht, können geleimte Brettschichtquerschnitte mit keilgezinkten Längsstößen der Brettlamellen in praktisch beliebiger Länge bei Höhen bis über 2 m und mit mehrfachen Brettbreiten hergestellt werden. Zudem wird durch die Lamellierung ein gewisser Vergütungseffekt der Längsfestigkeiten gegenüber Vollholz erreicht, die Rißbildung infolge der Verleimung der künstlich getrockneten Bretter eingeschränkt, wodurch vor allem die Beeinträchtigung der Schubfestigkeit verringert und eine Festigkeitserhöhung durch den geringeren Feuchtegehalt bewirkt wird. Da die Brettlamellen vor dem Verleimen bei einem Biegehalbmesser von mehr als 200 x Brettstärke praktisch ohne Beeinträchtigung der Längsfestigkeiten des verleimten Rechteckquerschnittes gebogen werden können, lassen sich leicht Träger und Rahmen mit gekrümmten Bereichen herstellen (Bild 1). Die leichte Formgebung der Brettschichtrohlinge durch Sägen und Hobeln begünstigt auch Trägerformen mit linear veränderlichen Querschnittshöhen nach Bild 2 sowie

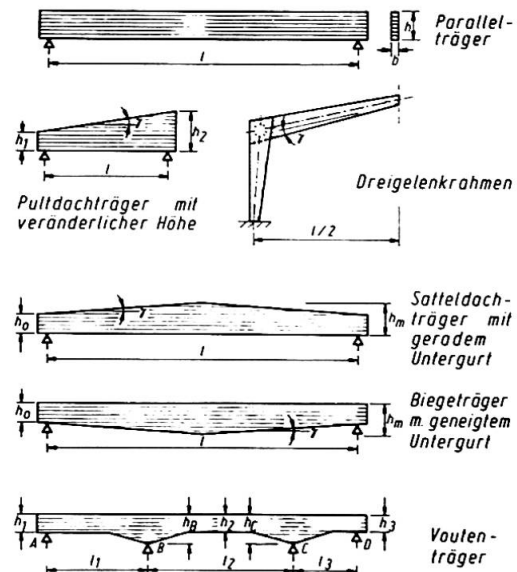
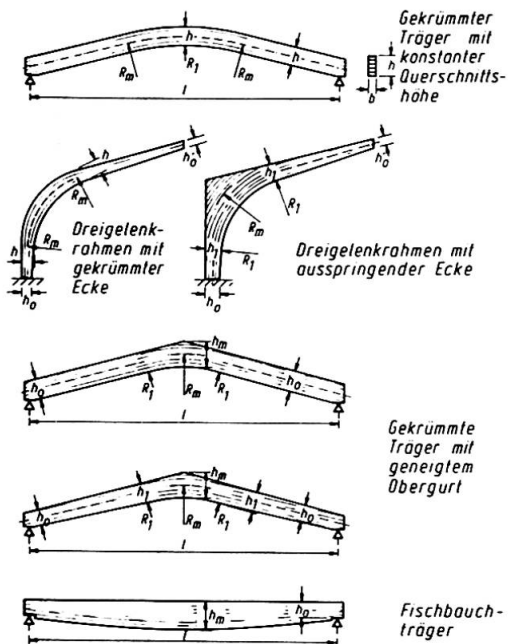

**Bild 1:** Träger und Rahmen mit gekrümmten Querschnittsrändern

**Bild 2:** Brettschichtträger mit linear veränderlichen Querschnittshöhen

Ausklinkungen im Auflagerbereich, Trägerdurchbrüche und ähnliche Ausbildungen, die aber im Hinblick auf die geringe Querfestigkeit des Holzes besondere Nachweise oder zusätzliche Verstärkungsmaßnahmen erfordern.

Die Anisotropie des Holzes in Bezug auf das Festigkeits- und Verformungsverhalten und das durch Feuchteänderungen bedingte Quellen und Schwinden hat zur Entwicklung plattenförmiger Holzwerkstoffe geführt, die heute als Sperrholz-, Span- und Faserplatten auch für statisch beanspruchte Bauteile verwendet werden. Sie stehen in Dicken bis 80 mm, Breiten bis ca. 2 m und Längen bis 8 m zur Verfügung. Platten für das Bauwesen müssen neben Feuchtigkeitsbeständigkeit bestimmte mechanische Eigenschaften aufweisen, so daß sie nach statischen Gesetzmäßigkeiten bemessen werden können. Sie finden bevorzugt Anwendung als Beplankung von Holztafeln, die als Wand-, Decken- oder Dachtafeln flächenhafte Bauteile des Fertigbaues bilden. Dabei werden sie in serienmäßiger Fertigung mit den Holzrippen verleimt, vernagelt oder durch Klammern verbunden. Sperrholzplatten eignen sich darüber hinaus besonders als Knotenplatten, Stoßlaschen und Stege von I- oder Kastenträgern. Derartige geleimte oder genagelte Verbundbauteile lassen sich nach den Regeln für Verbundquerschnitte berechnen und können praktisch ohne Einschränkung der Elementgröße für die Belange des Fertigbaues hergestellt werden.

### 3. VERBINDUNGSTECHNIK

Die neuartigen Verbindungsmittel des Holzbaues sind weitgehend in den Vorberichten behandelt worden. Während die Leimverbindung als Längsverleimung praktisch nur bei Brettschichtholz und den Holztafeln angewendet werden kann, spielt die Schrägverleimung bei der

Keilzinkenverbindung - heute oft auch bei großen Querschnitten als Montagestoß ausgeführt - und den kleinflächigen Verleimungen von Fachwerkträgern besonderer Bauart eine Rolle. Leimverbindungen können als starre Verbindungen angesehen werden. Im Gegensatz hierzu sind mechanische Holzverbindungen, (Nägel, Dübel, Stabdübel, Klammern, Nagelplatten u. ähnliche) nachgiebige Verbindungen, bei denen mit zunehmender Belastung eine meistens progressiv mit der Belastung und oft auch der Belastungszeit anwachsende Verschiebung zwischen den zu verbindenden Teilen auftritt, wie beispielhaft aus Bild 3 hervorgeht. Hierdurch werden bei zusammengesetzten Querschnitten Steifigkeit und Tragfähigkeit des Bauteils bestimmt, was



Bild 3: Kraftverschiebungsdiagramme mechanischer Holzverbindungen

bei Biege- und Druckgliedern durch Berechnung des wirksamen Trägheitsmomentes berücksichtigt werden muß. Bei Fachwerken, Gitterstützen und ähnlichen Konstruktionen ist der Einfluß der Nachgiebigkeit von Stabanschlüssen und Stößen ebenfalls meist beim Verformungs- und Tragfestigkeitsnachweis nicht zu vernachlässigen.

Die Entwicklung verbesserter mechanischer Verbindungsmittel und von Möglichkeiten, Leimverbindungen in größerem Umfange für den konstruktiven Holzbau nutzbar zu machen, ist vielerorts Gegenstand von Forschung und Praxis. Es seien nur die eingeleimten Gewindestähle, Holz-Kunststoff-Kombinationen, verbesserte Kleber (weniger starr, fugenfüllend, sägerauhe Oberflächen, weniger feuchteempfindlich) genannt. Damit werden in Zukunft sicher weitere konstruktiv und wirtschaftlich günstigere Verbindungsmöglichkeiten zur Verfügung stehen (siehe auch Beitrag von H. Blumer).

#### 4. BERECHNUNGSVERFAHREN

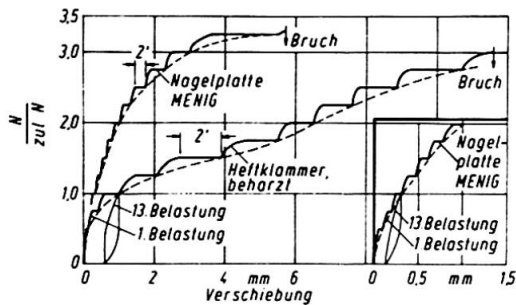
Die Berechnungsverfahren für Holzkonstruktionen wurden in den letzten 15 Jahren weltweit wesentlich erweitert und dem wirklichen Festigkeits- und Verformungsverhalten der Werkstoffe und Verbindungskonstruktionen angepaßt. Dabei ergaben sich in manchen Teilbereichen bedeutende Änderungen gegenüber den früheren, oft stark vereinfachten Rechennachweisen. Neue Verbindungstechniken, neue Werkstoffe, neue Konstruktionsformen einerseits, aber vor allem die von der Holzforschung erarbeiteten Ergebnisse andererseits machten es erforderlich, für die neuen Gegebenheiten zutreffendere Berechnungsverfahren auszuarbeiten. Geht man von dem etwa vor 10 Jahren vorliegenden Stand aus, wie er z.B. durch die deutsche DIN 1052, Holzbauwerke, Berechnung und Ausführung aus dem Jahre 1969 und den Anfang der siebziger Jahre erschienenen Bemessungsvorschriften anderer Länder fixiert ist, so ergibt sich die Notwendigkeit, die bisherigen Verfahren teilweise zu erweitern und eine Reihe neuer Bemessungsgrundlagen zur Anwendung zu bringen. Die wichtigsten



hiervon, die z.B. weitgehend bei der z.Zt. beratenen Neufassung der DIN 1052, aber auch im CIB-Entwurf, der als Grundlage der ISO-Norm dienen soll, berücksichtigt werden sollen, seien hier kurz aufgeführt.

#### 4.1 Nachgiebig zusammengesetzte Biege- und Druckglieder

Mit dem wirksamen Trägheitsmoment  $I_W$ , für das die Berechnungsgleichungen weitgehend bekannt sind, lassen sich Spannungsverteilung und Durchbiegung bei Biegegliedern genau genug erfassen und die wirksamen Schlankheitsgrade  $\lambda_W$  von Druckgliedern bestimmen. Bei Rahmen- und Gitterstützen, für die heute anstelle der komplizierten, "genaueren" Bemessungsgleichungen meist aus Versuchen erhaltene Näherungen verwendet werden, scheinen Verbesserungen möglich (siehe Beitrag Malho tra: Rational Approach to the Design of Built-up Timber Columns).

#### 4.2 Nachweis nach Theorie II.Ordnung

Beim Stabilitätsnachweis und bei der Schnittkraftermittlung statisch unbestimmter Konstruktionen wie Rahmen- und Bogentragwerke, bei denen die Nachgiebigkeit der Lager- und Knotenpunkte das Ergebnis beeinflussen kann, ist oft ein Nachweis nach Theorie II.Ordnung zweckmäßig. Hier bestehen allerdings noch keine übereinstimmenden Auffassungen über die anzusetzenden Festigkeits- und Sicherheitswerte.

#### 4.3 Nachweis der Querkzugbeanspruchungen

Die geringe Querkzugfestigkeit des Holzes hat wiederholt zu Schadensfällen, vorwiegend bei Konstruktionsformen des Holzleimbaues geführt, bei denen bisher rechnerisch nicht erfaßte Querkzugbeanspruchungen, oft von unvermeidlichen Schwindspannungen überlagert, zur Ribbildung geführt haben. Besonders querkzuggefährdet sind gekrümmte Träger und Satteldachträger. Bei den letzteren ist die Höhe der maximalen Querkzugspannung im gefährdeten Bereich nicht nur vom Krümmungsverhältnis: Biegeradius zu Querschnittshöhe, sondern auch von den Neigungswinkeln der Trägerkanten abhängig. Hierauf ist im Vorbericht eingegangen worden.

Querkzugspannungen, wie sie z.B. bei Queranschlüssen nach Bild 4,



Bild 4: Versagen eines Stabdübel-Queranschlusses durch Querkzugversagen des Brett-schichtholzes

bei angehängten Lasten und ähnlichen Konstruktionen auftreten, lassen sich rechnerisch schwer erfassen. Aufgrund von Versuchen mit Stabdübel-, Balkenschuh- und Nagelplatten-Anschlüssen können näherungsweise die aufnehmbaren Kräfte nach der Beziehung:

$$F_{\perp} = \text{zul } \sigma_{\perp} \cdot A_w \cdot f\left(\frac{a}{H}, \frac{D}{H}\right)$$

berechnet werden.

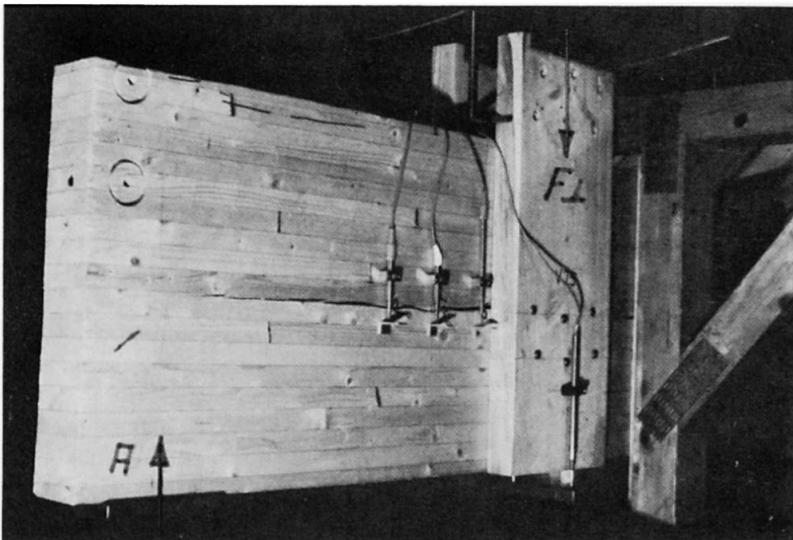
Hierbei ist  $A_w$  die für die Aufnahme der querwirkenden Last  $F_{\perp}$  wirksame Holzfläche und  $f\left(\frac{a}{H}, \frac{D}{H}\right)$  ein Faktor, der den Einfluß der Anordnung der Verbindungsmittel in Bezug auf die Trägerhöhe  $H$  erfassen soll. Nach Festlegung der Größen  $\text{zul } \sigma_{\perp}$  und  $A_w$  läßt sich der Faktor  $f\left(\frac{a}{H}, \frac{D}{H}\right)$  aus entsprechenden Versuchsergebnissen bestimmen.

Beispielhaft ist in Bild 5 das Ergebnis umfangreicher Balkenschuhversuche ausgewertet, für welche die Abhängigkeit des Faktors  $f$  vom

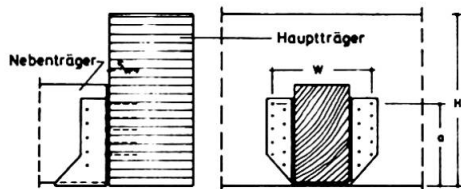

#### Balkenschuh - Anschluß

Zulässige Anschlußkraft bei Querkzugfahrt  
 $\text{zul } F_{\perp} = \text{zul } \sigma_{\perp} \cdot A_w \cdot f\left(\frac{a}{H}\right)$  in N  
 $\text{zul } \sigma_{\perp} = 0,4 \text{ N/mm}^2$ ,  $A_w = w \cdot s_w$  in  $\text{mm}^2$

Bild 5: Auswertung von Versuchen mit Balkenschuh-Anschlüssen an Voll- und Brett-schichtholz-Träger

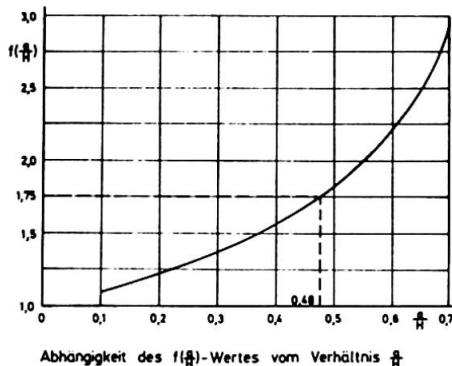

vom Verhältnis  $a/H$  bei einer zulässigen Querkzugspannung von  $\text{zul } \sigma_{\perp} = 0,4 \text{ N/mm}^2$  und einer wirksamen Holzfläche  $A_w = w \cdot s_w$  ermittelt wurde. Da bei diesen Versuchen das Verhältnis  $D/H$  keinen feststellbaren Einfluß hatte, wurde es hier vernachlässigt.

Die Festlegung einer allgemein gültigen zulässigen Querkzugspannung für verschiedene Konstruktionsformen bereitet erhebliche Schwierigkeiten, da - wie aus Bild 6 hervorgeht - nach Versuchen an Blockproben, gekrümmten Trägern und Satteldachträgern in natürlicher Größe die Querkzugfestigkeit vom beanspruchten Volumen abhängig ist [1, 2].



Bild 5: Abhängigkeit der Querkzugfestigkeit vom querkzugbeanspruchten Volumen bei Brettschichtholz

#### 4.4 Berücksichtigung von Spannungsinteraktionen

Für Konstruktionsformen, bei denen an den kritischen Stellen gleichzeitig Längs-, Quer- und Schubspannungen auftreten, müssen Berechnungsverfahren zur Verfügung stehen, die es ermöglichen die Bruchgefahr für die kritische Stelle zu erfassen; denn hier treten die ersten Risse auf, die das völlige Versagen des Bauteils zur Folge haben können. Dies ist z.B. beim rechtwinklig am Auflager ausgeklinkten Träger nach Bild 7a der Fall, wo das gleichzeitige Auftreten von Längs-, Schub- und Querspannungen in der einspringenden Ecke ein frühzeitiges Versagen bewirkt. Nach [3] kann die zulässige Querkraft für den Endquerschnitt  $b \cdot h_1$  zu  $zul Q = \frac{2}{3} \cdot b \cdot h_1 \cdot k_A \cdot zul \tau_{II}$  berechnet werden, wobei der Abminderungswert  $k_A = 1 - 2,8 \frac{a}{h} \geq 0,3$  beträgt. Eine volle Ausnutzung des Endquerschnitts ist nur bei schräger Ausklinkung mit genügend flacher Neigung nach Bild 7b oder bei besonderen Verstärkungsmaßnahmen möglich.

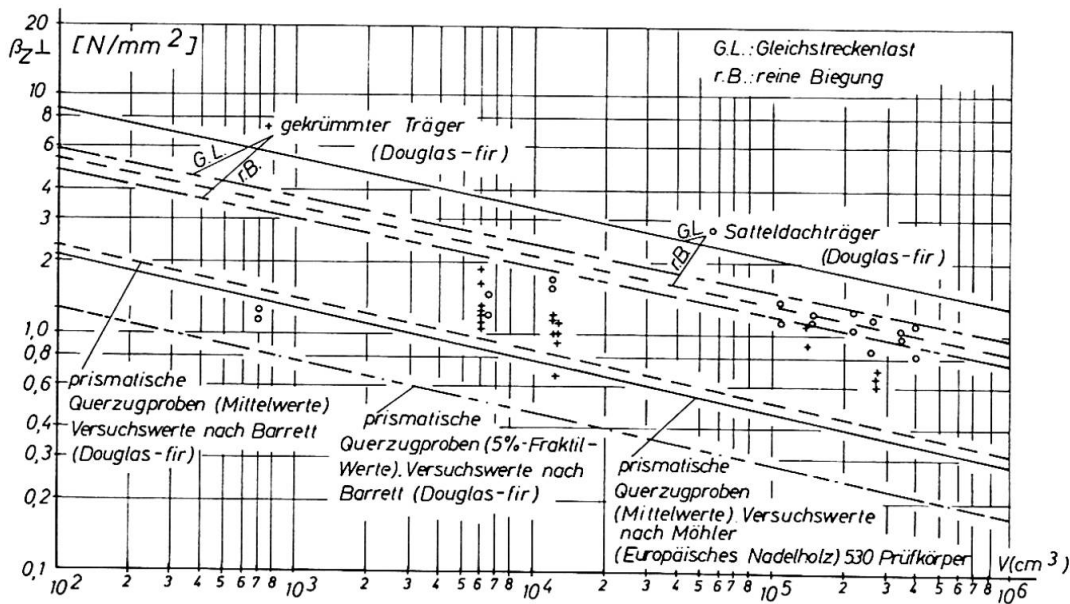

Bild 7: Ausgeklinkte Trägerauflager, Bemessungsgleichungen für die zulässigen Auflagerkräfte bei senkrechter und schräger Ausklinkung



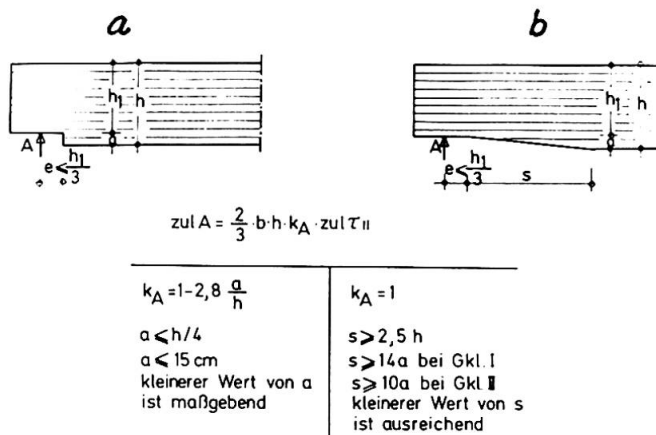

Spannungskombinationen, wie sie im gleichen Holzelement bei zur Faserrichtung unter einem gewissen Winkel verlaufenden Kanten oft bei Brettschichtbauteilen auftreten, können nicht nur an Zugrändern, sondern auch an Druckrändern das völlige Versagen einer Konstruktion verursachen, wie es bei Durchlaufträgern mit voutenförmigem Querschnittsverlauf im Bereich der Zwischenstützen wiederholt beobachtet wurde.

Versuche mit Trägern in natürlicher Größe [4] und die Auswertung von Schadensfällen haben ergeben, daß die schon 1962 von Norris [5] vorgeschlagene Bemessungsformel für den Zugbereich weitgehend zutrifft, während sie für den Druckbereich zu sehr auf der sicheren Seite liegt. Nach dem Ergebnis der Karlsruher Untersuchungen ist eine entsprechende Korrektur möglich, so daß der Nachweis der Randspannung an der maßgebenden Trägerstelle nach der Beziehung:

$$\text{vorh } \sigma_{B\parallel} = k_{D,Z} \cdot \sigma_{B\parallel} \leq k_{D,Z} \cdot \text{zul } \sigma_{B\parallel}$$

geführt werden kann. Für Brettschichtholz der Güteklasse I mit  $\text{zul } \sigma_B = 14 \text{ N/mm}^2$  ergaben sich die in Bild 8 dargestellten Abhängigkeiten der  $k_D$  und  $k_Z$  Werte vom Winkel  $\alpha$  zwischen Rand- und Faserrichtung.



Bild 8: Abminderungswerte  $k_{D,Z}$  bei schrägem Trägerrand

#### 4.5 Weitere neue Bemessungsgrundlagen

Außer den oben kurz behandelten Beispielen neuer Bemessungsgrundlagen ist noch eine weitere Reihe von Erweiterungen zu nennen, für die teilweise bereits Vorschläge vorliegen oder die Gegenstand noch nicht abgeschlossener Untersuchungen sind. Es sei nur auf folgende Themen hingewiesen:

- a) Bemessung von torsionsbeanspruchten Bauteilen und Festlegung zulässiger Torsionsspannungen einschließlich Torsion + Querkraft [6].
- b) Erfassung des Langzeitverhaltens von Holz, Holzwerkstoffen und Holzverbindungen bei Biege- und Druckgliedern.
- c) Angabe von Bemessungslasten für Aussteifungskonstruktionen (Verbände, Scheiben) zur Knick- oder Kippsicherung gedrückter Holzbauteile.
- d) Einheitliche Bemessungsangaben für neue Verbindungsmittel und Verbindungstechniken wie Sondernägeln, Klammern, Nagelplatten, Balkenschuhe und andere Stahlblech-Formteile.

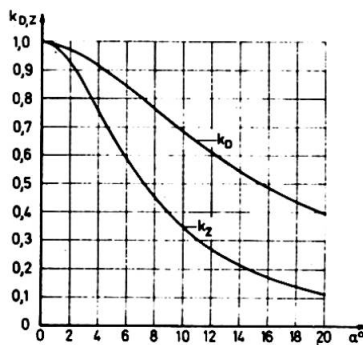

Es ist anzustreben, die Bemessungsgrundlagen weitgehend einheitlich in die Holzbaunormen der einzelnen Länder und vor allem in die in Vorbereitung befindliche ISO-Holzbaunorm aufzunehmen.

## 5. SCHLUSSBEMERKUNGEN

Die Entwicklung des Ingenieurholzbaues ist zwar durch einige spektakuläre Holzbauwerke der letzten Jahre in besonderem Maße in das Bewußtsein des konstruktiv schaffenden Ingenieurs getreten, er hat aber in dieser Zeit in vielfältiger Weise auch bei üblichen Hoch- und Brückenbauten mit neuen Konstruktionsformen wieder Eingang gefunden. Diese wurden durch neue Werkstoffe auf Holzbasis, neue oder verbesserte Verbindungsmittel und arbeitssparende, wirtschaftliche Verbindungstechniken ermöglicht, wobei vor allem die Brettschichtbauweise zu nennen ist. Die rechnerische Erfassung der neuen Bauteil- und Tragwerkformen führte zur Weiterentwicklung der traditionellen Holzbaustatik und machte die wissenschaftliche Erforschung des Trag- und Verformungsverhaltens der Holzkonstruktionen notwendig. Die folgenden Beiträge zeigen, daß der Ingenieurholzbau heute in Theorie und Praxis noch nicht seinen Endzustand erreicht hat und auf zahlreichen Teilgebieten eine Weiterentwicklung der Holzkonstruktionen im Sinne des Konstruktiven Ingenieurbaues im Gange ist.

## LITERATURVERZEICHNIS

- 1 Möhler, K.: Spannungsberechnung von gekrümmten Brettschichtträgern mit konstanter und veränderlicher Querschnittshöhe  
Bauen mit Holz, 1979, S. 364/67
- 2 Barrett, J.D.; Foschi R.O.; Fox, S.P.: Perpendicular-to-Grain Strength of Douglas Firs. Canadian Journal of Civil Engineering. Volume 2, Nr. 1, S. 50/57, 1975
- 3 Möhler, K. und L. Mistler: Ausklinkungen am Endauflager von Biegeträgern.  
Bauen mit Holz, 1979, S. 577/78
- 4 Möhler, K. und Kl.Hemmer Spannungskombination bei Brettschichtträgern mit geneigten Rändern  
Bauen mit Holz, 1980, S. 355/57
- 5 Norris, Ch.B.: Strength of orthotropic materials subjected to combined stresses. Forest Products Laboratory Madison, Nr. 1816, 1962
- 6 Möhler, K. und Kl.Hemmer: Verformungs- und Festigkeitsverhalten von Nadelvoll- und -Brettschichtholz bei Torsionsbeanspruchung, Holz als Roh- und Werkstoff 35 (1977), S. 473/78

Leere Seite  
Blank page  
Page vide



## II

**Research on Double-Tapered Glulam Beams**

Recherches sur des poutres à hauteur variable en lamellé-collé

Untersuchungen über das Tragverhalten von Satteldachträgern aus Brettschichtholz

**RICHARD M. GUTKOWSKI**

Prof. of Civil Engineering  
Colorado State University  
Ft. Collins, CO, USA

**GEORGE R. DEWEY**

Structural Engineer  
J. F. Sato and Associates  
Denver, CO, USA

**SUMMARY**

Reliability based design and limit states design have the advantage of unifying codes and establishing consistent safety margins. Improved knowledge of ultimate strength performance and service load displacements, based on refined analysis procedures and experimental verifications, are important prerequisites to such code formats. This paper reports a recent theoretical and experimental study of the service and ultimate behavior of double-tapered glulam beams. Important implications for future design codes are briefly described.

**RESUME**

Les méthodes de dimensionnement basées sur les états limites permettent une meilleure vue d'ensemble des différentes normes et la détermination des facteurs de sécurité. On peut améliorer les connaissances sur la résistance ultime et les déformations sous charges de service par des méthodes de calcul sophistiquées et par des essais en laboratoire; ceci est une condition essentielle pour pouvoir appliquer la théorie aux états limites. On décrit, dans cet exposé, les résultats d'une étude théorique et expérimentale effectuée sur des poutres en lamellé-collé à hauteur variable. On a étudié le comportement sous les charges de service ainsi que la résistance ultime. On décrit brièvement quelques points importants dont il faudrait tenir compte lors de l'élaboration de futures normes.

**ZUSAMMENFASSUNG**

Auf Grenzzuständen beruhende Bemessungsmethoden erleichtern die Vereinheitlichung der Normen und ermöglichen die Festlegung der Sicherheitsmargen. Verbesserte Kenntnisse über Grenztragwiderstand und über das Verformungsverhalten unter Nutzlasten, die sowohl durch verfeinerte Berechnungsverfahren als auch durch Versuche erreicht werden, sind hierfür wichtige Voraussetzungen. Dieser Beitrag berichtet über eine neuere theoretische und experimentelle Untersuchung über das Verformungs- und Tragverhalten von geraden Satteldachträgern aus Brettschichtholz. Daraus ergeben sich wichtige Folgerungen für zukünftige Normen.

## 1. INTRODUCTION

Glued-laminated timber (glulam) beams are popular structural members in buildings, bridges and other structures. As such a sound understanding of the physical behavior of any such member is essential. It is important that glulam members be accurately modeled in accordance with their inhomogeneous, orthotropic material properties. Rapid computer analysis methods are now commonplace and permit the analyst to eliminate many of the former analytical assumptions. The finite element method of analysis is a well established method of analysis and has been shown [1,2,3,4] to produce improved solutions to many problems involving wood. Analytical and experimental work reported in this paper indicates similar success for this method in the analysis of double-tapered glulam beams.

## 2. SCOPE OF THE STUDY

The analysis of a double-tapered shape (Fig. 1) is a complex problem. Unusual stresses are induced in the member by virtue of the varying cross-section. Concentration of stresses at the apex, possible deep beam behavior, and potential radial ( $\perp$  to grain) stresses further complicate the analysis. Analytical studies and a full-scale testing program comprise the major components of this paper and are part of a more extensive investigation to be reported later. In the experimental study, four full-size double-tapered members are investigated at working and ultimate loads. Results are compared with related past research and theoretical predictions obtained by an established orthotropic finite element technique [5] applied to the model in Fig. 2.

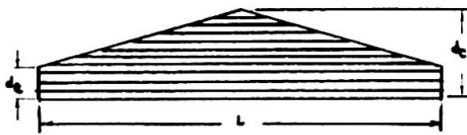

Fig. 1 Typical Beam

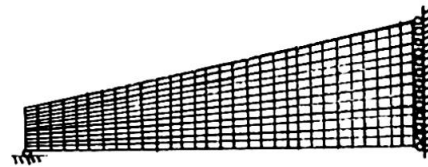

Fig. 2 Finite Element Mesh

## 3. BACKGROUND

Much research has been aimed at accurately predicting radial tension stresses. Wilson [6] studied the radial tension problem in 1939. He employed the simple radial stress formula

$$f_r = \frac{3}{2} \frac{M}{Rbd} \quad (1)$$

in which  $R$  = radius of curvature;  $M$  = applied bending moment;  $b$  = width of beam, and  $d$  = depth of beam. The formula is strictly correct only for a curved member of constant cross section subject to pure bending and is extremely conservative for pitched and curved beams of variable cross section. Norris [7] verified Wilson's formula by adopting a plane stress solution obtained by Carrier [8] in his study of curved wood beams (of constant cross section and subjected to pure bending).

In a succession of studies Foschi [9,10,11,12] and Fox [13] worked independently and in collaboration [14] to determine stress distributions in the central portion of double-tapered pitched and curved timber beams subjected to combined

bending, shear and axial forces. Elasticity solutions (experimentally verified) were used and a significant outcome of their work was the prediction of maximum radial stress according to

$$f_r = K_r \frac{6M}{bd^2} \quad (2)$$

in which  $K_r$  is a radial stress factor depending on the pitch of the upper edge and  $d_c$  is the midspan depth. Values predicted by Eq. 2 are for pure bending and proved to be (overly) conservative for other loadings. Equation 2 has been incorporated in some design codes [15,16].

Thut [2] developed and employed an orthotropic trapezoidal finite element model to determine the stress distributions in the central portion of pitched-tapered and curved glulam beams. He recommended stress factors for maximum radial tension and compression stresses at the apex section due to pure bending. Later studies by Gopu [3,4] were aimed at developing a rational design procedure for double-tapered pitched and curved beams. His experimental study consisted of testing six full-size unreinforced and two reinforced Douglas-fir beams. A key finding was that failure in members of practical configuration (including reinforced members) occurs in a radial tension mode. He also conducted an extensive parameter study using a modified version of Thut's orthotropic finite element model. Double-tapered beams with straight soffits were included in the range of the parameter study. Gopu refined Eq. 2 to provide more accurate prediction of the maximum radial stress for uniformly loaded members and developed a similar formula for determining the maximum flexural stress.

Previous research on straight-bottomed tapered beams has been limited. In an early study Maki and Kuenzi [17] derived closed-form theoretical equations for the principal stresses. An equation for flexural stress was derived using elementary Bernoulli-Euler theory of bending for an isotropic material. Expressions for maximum shear and radial stresses, at a section, were developed as functions of the flexural stress, the pitch of the taper and material properties. Tests were conducted on small specimens of aluminum and Sitka Spruce. However, none were tested to failure. It was further recommended that the interaction of the principal stresses, as proposed by Norris [18] be used to predict the ultimate strength of straight-bottomed tapered beams. The findings of Maki and Kuenzi are the basis of design methods presently required in one code [15].

#### 4. EXPERIMENTAL WORK

##### 4.1 Specimens

Four specimens (Table 1) were tested at working and ultimate load in a simple beam configuration. Moisture content at time of testing ranged from 5 to 7% for

Table 1

Specimens	$d_e$ (in)	$d_c$ (in)	width (in)	span (ft)	MOE (psi)	$E_R$ (psi)
DF42DT	12	42	5 1/8	30	2,030,000	56,000
SP42DT	12	39	5	30	1,460,000	78,000
DF27DT	12	27	5 1/8	30	2,040,000	44,000
SP27DT	12	27	5	30	1,530,000	60,000

DF = Douglas-fir (1 1/2 in. lams), SP = southern pine (1 in. lams),  
DT = double-tapered.





Douglas-fir and 6 to 8% for southern pine. Listed MOE values are the average value for all laminations. In the finite element analysis these values were used except for the row of elements adjacent to the straight bottom. For the bottom row elements, a weighted MOE was used based upon the proportion of the element area occupied by tension laminations and lesser grade material.  $E_R$  values were measured from compression tests on undamaged pieces of the tested specimens. All other elastic parameters were calculated by a known procedure [19] which uses the longitudinal modulus as a predictor.

#### 4.2 Conduct of Tests

Each beam was subjected to a pair of symmetrically placed loads located 4 ft to each side of the apex. Loads were applied to a spreader beam by a single hydraulic actuator. Stabilizer frames were used to prevent lateral motion. In the working load tests both longitudinal ( $\parallel$  to grain) and radial ( $\perp$  to grain) strains were recorded by specially devised strain transducers [3,4]. Deflection at various locations were measured by direct current displacement transducers. In the ultimate load tests no strain data was taken and only midspan load-deflection data was measured.

#### 4.3 Results

For repetitive working load tests, load deflection data was essentially identical for all cycles and was linear elastic. The "total" (actuator) loads applied were 10000 lbs. and 6000 lbs. for the nominal 42 inch and 27 inch deep specimens, respectively. No measurable creep or visible distress occurred. Results of the ultimate load tests are as follows:

DF42DT - Radial tension failure at mid-depth of the centerline at a total load of 52000 lbs. Maximum deflection was 2.5 in.

SP42DT - Bottom finger joint (96 in. from one end) failed at a total load of 46000 lbs. Continued loading to a 54000 lbs total produced a flexural failure at the same location. Maximum deflection was 3.3 in.

DF27DT - Radial tension failure at midspan 18" above the bottom surface at a total load of 24800 lbs. Maximum deflection was 2.34 in.

SP27DT - Flexural failure initiated at a finger joint (48 in from centerline) at a total load of 33000 lbs. Maximum deflection was 3.50 in.

### 5. COMPARISON WITH THEORIES

#### 5.1 Stresses

Longitudinal and radial strain data had to be measured at different locations through the depth of each selected cross-section. A least-squares fit to each strain distribution was employed to produce values at common points before conversion to stresses were made. A third degree polynomial was found to give good fits to the resulting stress distributions. Midspan experimental flexural stress distributions are compared with the finite element predictions in Fig. 3 and 4. Results for the other specimens were very similar.

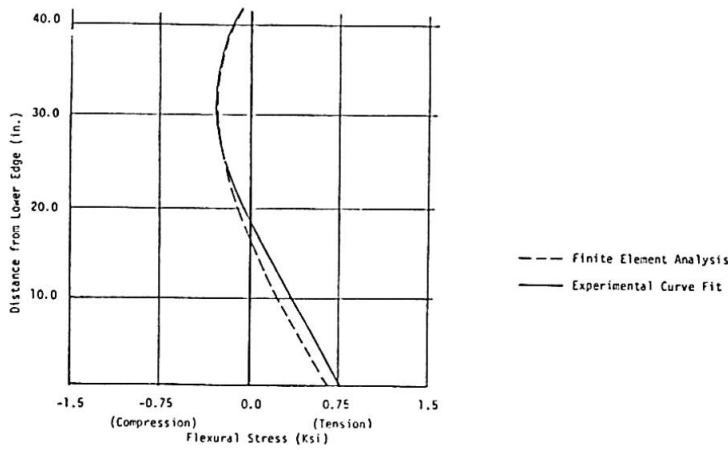

Fig. 3 DF42DT Flexural Stress

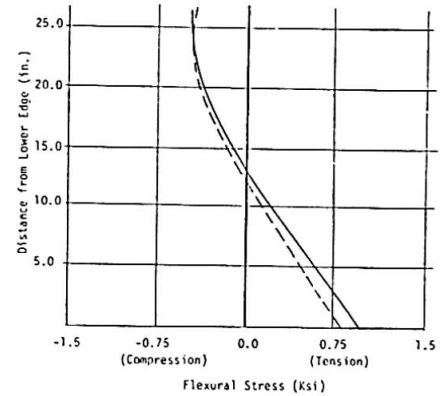

Fig. 4 SP27DT Flexural Stress

Radial stress comparisons are shown in Figs. 5 and 6. Discrepancies evident in some cases are partially attributed both to the sensitivity of the theoretical values to  $E_R$ , which exhibited high variability, and the high scatter in MOE values of the individual laminations.

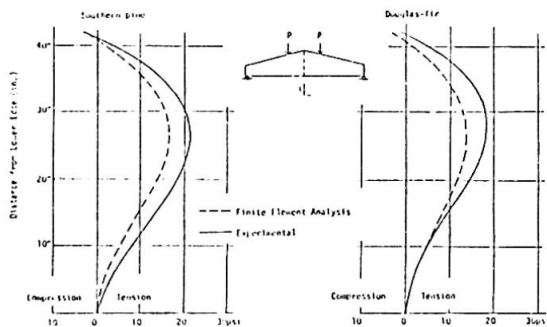

Fig. 5 Radial Stress for 42" Beams

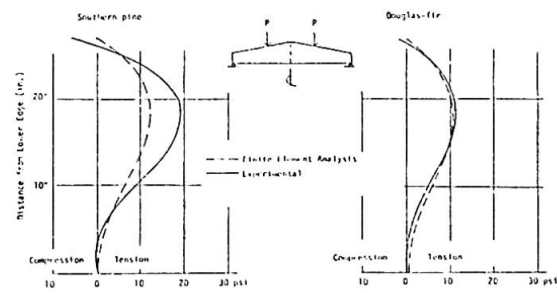

Fig. 6 Radial Stress for 27" Beams

Table 2 lists various theoretical stress comparisons for the ultimate load values. All bending stresses are tensile and the absolute maximum in the span.

Table 2 Stresses at Failure

Specimen No.	Failure Load (lbs.)	Maximum Bending Stress at Failure (psi)		Maximum Radial Tension Stress at Failure (psi)	
		FEM	Mc/I	FEM	AITC [15]
		DF42DT	52000*	4590	3810
SP42DT	54000	5000	4500	91.8	90.9
DF27DT	24800* <sup>‡</sup>	4180	3620	53.2	47.3
SP27DT	33000	4840	4940	70.4	64.5

\* Failed in radial tension (listed bending stress did not control)

<sup>‡</sup> DF27DT was reloaded to 29600 lb after initial radial tension failure

As noted earlier, the finite element maximum flexural stress predictions exceed those of the classical Bernoulli-Euler theory. This is true even in the two cases where radial tension governed the failure.

Two design codes [15,16] provide graphical aids for determining  $K_r$  for double-



tapered, pitched and curved beams. Values for straight bottom beams can be obtained by extrapolating the curves to the case where  $d_c/R_m$  is equal to zero. A comparison of these values with those predicted by the finite element model is included in Table 2. Excellent agreement is obtained for all specimens.

## 5.2 Deflections

Deflection data recorded in the working range tests were compared with the finite element results and a conventional method. Conventional values were calculated by use of Castigliano's theorem and numerical integration. The MOE values listed in Table 1 were employed.

Table 2. Centerline Deflections at Working Load Limit

Specimen No.	Centerline Deflection Experimental (in.)	Finite Element Analysis Deflection (in.)	% Difference with Expt.	Castigliano's Theorem Deflection (in.)	% Difference with Expt.
DF42DT	0.417	0.446	+ 6.9	0.389	- 6.8
SP42DT	0.586	0.583	- 0.5	0.539	- 8.1
DF27DT	0.591	0.623	+ 5.4	0.604	+ 2.3
SP27DT	0.789	0.823	+ 4.2	0.780	- 1.2

It appears that the finite element method overestimates the midspan deflection by as much as 7%. Conversely, treatment of wood as an isotropic material, as inferred in the use of Castigliano's theorem, results in unconservative deflection values. In these cases, the deflection is underpredicted by as much as 8%. Shear deflection ranged up to 16% of the flexural deflection. The 16% values was for DF42DT. The finite element model inherently includes shear deformation and its isolated effect cannot be distinguished from the total.

## 6. CONCLUSIONS

Several significant findings were noted in this work

- Flexural stress distributions measured or calculated by the FEM are curvilinear in the central region and linear near the ends. Extreme fiber tensile stresses equal or exceed the compressive stress at all sections and are greater than predicted by  $M_c/I$ . These observations are in agreement with past findings [17].
- Radial stresses exist in the central region with the maximum at centerline. The stress mode governed the failure of the Douglas-fir specimens. This is significant because current design codes do not require a check of this stress condition. Use of the  $K_r$  factor method for  $d_c/R_m = 0$  is a possible means for making this check.
- Maximum horizontal shear stress is some distance away from the supports and at the tapered surface. This is contrary to  $VQ/It$  but agrees with past work [17].
- Locations and modes of failure were not in agreement with the interaction formula for combined stresses.
- Castigliano's theorem underestimates the midspan deflection.

Detailed discussion of these points can be found in the complete report [20].

## REFERENCES

1. Al-Dabbagh, A., J. R. Goodman, and J. Bodig, "Finite Element Method for Wood Mechanics", J. Structural Division, ASCE, Vol. 98, No. ST3, Mar. 1972.

2. Thut, W. K., "Stresses in Pitch-Cambered Glulam Beams", M. S. Thesis, University of British Columbia, 1970.
3. Gopu, V. K. A., "Analysis of Double-Tapered Curved Glued-Laminated Beams", M.S. Thesis, Colorado State University, 1972.
4. Gopu, V. K. A., "Behavior and Design of Double-Tapered Pitched and Curved Glulam Beams", Ph.D. Dissertation, Colorado State University, 1976.
5. Bathe, K. J., E. L. Wilson, and F. E. Peterson, (1973), "SAP IV - Structural Analysis Program for Static and Dynamic Response of Linear Systems", Report No. EERC 73-11, University of California, Berkeley.
6. Wilson, T. R. C., "The Glued Laminated Wooden Arch", USDA Tech. Bulletin, No. 691, Wash. D.C., 1939.
7. Norris, C. B., "Stresses Within Curved Laminated Beams of Douglas-fir", FPL-202, Forest Products Laboratory, USDA, Madison, WI, 1963.
8. Carrier, G. F., "Stress Distributions in Cylindrically Aelotropic Plates", J. Applied Mechanics, Vol. 10, Trans. ASME Vol. 65, A-117-122, 1943.
9. Foschi, R. O., "Plane Stress Problem in a Body with Cylindrical Anisotropy, with Special Reference to Curved Douglas-fir Beams", Dept. of Forestry and Rural Development, Publication 1224, Ottawa, Ontario, 1968.
10. Foschi, R. O., "Point-Matching Analysis of Curved Timber Beams", J. Structural Division, ASCE, Vol. 96, No. ST1, 1971.
11. Foschi, R. O., "A Computer Program for the Stress Analysis of Curved Glued-Laminated Timber Beams", Forest Products Laboratory, Vancouver, British Columbia, 1970.
12. Foschi, R. O., "Stress in Curved Glued-Laminated Timber Beams: Experimental Study", Forest Products Research Society, Madison, Wisconsin, July, 1971.
13. Fox, S. P., "Strength and Deformation of Pitched-Tapered Douglas-fir Glued-Laminated Beams", Wood and Fiber, Vol. 6, No. 3, Fall 1974.
14. Foschi, R. O., and S. P. Fox, "Radial Stress in Curved Timber Beams", J. Structural Division, ASCE, Vol. 96, No. ST10, 1970.
15. Timber Construction Manual, American Insitute of Timber Construction, 1974.
16. Canadian Standards Association, "Code of Recommended Practice for Engineering Design in Timber", CSA - 086, 1976.
17. Maki, A. C., and E. W. Kuenzi, "Deflection and Stresses of Tapered Wood Beams", U. S. Forest Service Paper, FPL 34, Sept. 1965.
18. Norris, C. B., "Strength of Orthotropic Materials Subjected to Combined Stresses", FPL 1816, Forest Products Laboratory, USDA, Madison, WI, 1966.
19. Bodig, J., and J. R. Goodman, "Prediction of Elastic Parameters for Wood", Wood Science, Vol. 5, No. 4, April 1973.
20. Dewey, G., "Tests and Analysis of Single- and Double-Tapered Glulam Beams", M. S. Thesis, Colorado State University, 1979.



- NB. The following list of references refers to another article by R.M.Gutkowski, and should be read after page 213:
6. Scarisbrick, Richard G., "Laminated Timber Logging Bridges in British Columbia, J. Structural Division, ASCE, Vol. 102, No. ST1, Jan. 1976.
  7. Csagoly, P. F. and Taylor, R. J., "A Development Program for Wood Highway Bridges", SRR-7, Ministry of Transportation and Communications, Ontario, Canada, 1979.
  8. Taylor, R. J. and Csagoly, P. F., "Transverse Post-Tensioning of Longitudinal Laminated Timber Bridge Decks", Ministry of Transportation and Communications, Ontario, Canada.
  9. Glulam Bridge Systems - Plans and Details, American Institute of Timber Construction, Englewood, Colorado, 1974.
  10. McCutcheon, W. J. and Tuomi, R. L., "Procedure for Design of Glued-Laminated Orthotropic Bridge Decks", USDA Forest Service Research Paper FPL 210, Forest Products Laboratory, U.S.D.A., Madison, Wisconsin 1973.
  11. McCutcheon, W. J. and Tuomi, R. L., "Simplified Design Procedure for Glued-Laminated Bridge Decks," USDA Forest Service Research Paper FPL 233, Forest Products Laboratory, U.S.D.A., Madison, Wisconsin 1974.
  12. Gutkowski, R. M., "Glulam Bridge Dowel System" Technical Note, J. Structural Division, ASCE, Vol. 105, No. ST8, August, 1979.
  13. Gutkowski, R. M., Goodman, J. R. and Pault, J., "Tests and Analysis for Composite Action in Glulam Bridges", Transportation Research Records 676 - Bridge Design, Evaluation and Repair, Transportation Research Board, National Academy of Sciences, 1978.
  14. Pault, J. D., "Composite Action in Glulam Timber Bridge Systems", M.S. Thesis, Dept. of Civil Engineering, Colorado State University, Fort Collins, Colorado, 1977.
  15. Youngquist, J., Gromala, D., Jokerst, R., Moody, R., and Tschernitz, J., "Press-Lam Timbers for Exposed Structures", J. Structural Division, ASCE, Vol. 105, No. ST7, July, 1979.
  16. Subcommittee on Wood Research - ASCE, "Important Research Needs in Wood - As a Structural Material", J. Structural Division, ASCE, Vol. 105, No. ST10, October 1979.
  17. Journal of the Structural Division, ASCE, Vol. 104, No. ST9, Sept. 1978 (Collection of 8 papers).
  18. Zahn, J., "Reliability-Based Design Procedures for Wood Structures", Forest Products Journal, Vol. 27, No. 3, March 1977.
  19. Knab, L. I. and Moody, R. C., "Glulam Design Criteria for Temporary Structures", J. Structural Division, ASCE, Vol. 104, No. ST9, Sept. 1978.
  20. Sanders, W., Klaiber, F., Elleby, H., and Timm, L., "Ultimate Load Test of Truss Bridge Floor System", J. Structural Division, ASCE, Vol. 102, No. ST7, July 1976.
  21. Elleby, H., Sanders, W., Klaiber, F., and Reeves, M., "Service Load and Fatigue Tests on Truss Bridges", J. Structural Division, ASCE, Vol. 102, No. ST12, Dec. 1976.

**II****An energised (postflexed) 22 metre timber-plywood box beam**

Poutre précontrainte de 22 m de portée avec section en caisson et âmes en contre-plaqué

Vorgespannter Holzträger mit 22 m Spannweite mit Kastenquerschnitt und Stegen aus Sperrholz

**J. RAYMOND GILFILLAN**  
Dr.  
The Queen's University of Belfast  
Belfast, Northern Ireland

**E. HAROLD SIDWELL**  
The Queen's University of Belfast  
Belfast, Northern Ireland

**SUMMARY**

A new concept for energising structures of any material and its application to timber beams is outlined. The development, design and fabrication of a 22 m span by 1.2 m deep timber-plywood box beam are described. The behaviour of the beam during stressing and uniformly distributed loading was predictable from theory previously developed. On the basis of permissible stresses, application of the technique improved the load capacity by a ratio of 2.38. Testing to refusal produced a collapse at a total uniformly distributed load of 29.7 kN/m.

**RESUME**

On présente un nouveau concept pour la précontrainte des structures formées de différents matériaux et on l'applique aux poutres en bois. On décrit les calculs et la construction d'une poutre caisson de 1,2 m de hauteur, de 22 m de portée, et dont les âmes sont en contre-plaqué. A l'aide du modèle théorique développé, on a pu prédire le comportement de la poutre, chargée uniformément et précontrainte. Si on se base sur le concept des contraintes admissibles, cette nouvelle technique permet d'augmenter la charge maximale d'un facteur de 2,38. La charge expérimentale de 29,7 kN/m a conduit à la ruine de la poutre. On décrit encore brièvement quelques autres applications possibles.

**ZUSAMMENFASSUNG**

Ein neues Konzept für das Vorspannen von Bauwerken aus beliebigen Baustoffen und dessen Anwendung auf Holzträger wird dargestellt. Die Entwicklung, der Entwurf und die Herstellung eines 1,2 m hohen kastenförmigen Trägers mit Stegen aus Sperrholz und Spannweiten von 22 m werden beschrieben. Das Verhalten des Trägers infolge der Vorspannung und infolge einer gleichmässig verteilten Belastung wurde aufgrund einer früher entwickelten Theorie rechnerisch ermittelt. Auf der Grundlage der zulässigen Spannungen erreichte man eine Erhöhung der Belastbarkeit um den Faktor 2,38. Die Bruchlast wurde experimentell zu 29,7 kN/m ermittelt. Weitere Einsatzmöglichkeiten werden kurz behandelt.



## 1. INTRODUCTION

Normal prestressed concrete in flexure depends upon either concentric or eccentric compression, the medium (agent) employed usually being tensioned prestress wire inserted into the concrete member. The zone which is subject to tension from service loads is thus given an increased tensile strength. The potential of this technique, though tremendous, is not universally applicable to structural materials since only compressive energising forces can be employed, and tension in the concrete (or other stock material) can only be produced by increasing the cable eccentricity beyond the elastic core of the section: this has its difficulties and limitations. In addition the postflexure cannot be divorced from the longitudinal postcompression, which though needed in concrete may not be required for other materials.

The new concept developed by a team of 15 researchers endeavours to remedy this deficiency by concerning itself with the theory and practice of inducing tension into materials which are subject to direct and indirect compressive service stresses. Thus complete structures or structural elements can be tensioned, reducing or mitigating compressions as desirable to complement the reduction of tensions by compression as pioneered by Freyssinet [1] and so widely employed in concrete beams. Complete ability to change the statics of a structure or structural element in accordance with ones wishes can only spring from a controlled system of energising forces of both compression and tension. The concept, theoretically possible for both determinate and indeterminate structures and applicable to any structural material has thus a very wide potential use.

Some promising results have been achieved and it would appear that the practical realisation of a valuable new structural technique is now possible.

## 2. APPLICATION TO TIMBER BEAMS

Several workers have endeavoured to justify 'concrete type energising', with eccentrically placed tensioned cables for low quality timber, by the utilisation of its relatively higher compressive strength. [2] [3] However, when materials exhibit approximately equal tensile and compressive strength properties the longitudinal compressive component of the eccentric postcompression is a disadvantage. 'The application to structural steel of the methods employed for energising concrete [4] appear to have produced in the majority of cases a cost economy more illusory than real.'

An examination of flexural strength and deflection limitation design criteria for beams indicates a need for efficient distribution of cross sectional area as in a flanged section. Such a cross section shape conflicts with the use of low quality material and eccentric energising techniques since the core limit is close to the lower flange and additional eccentricity is required to oppose dead load flexural moment. Thus, at relatively large spans, a case can be established for the use of an energising system which applies flexure to a basic element made of material with nearly equal tensile and compressive properties. Even when dead load advantages are neglected the load capacity is doubled. This energising concept depends upon inducing flexure by means of compressed wires in the upper flange and tensioned wires in the lower flange. The application and variation of flexural moment can be accomplished by the cable arrangements indicated in Fig. 1. The area between the cables may be shown to correspond to the shape of the bending moment diagram due to the energising system.

The work now described is concerned with the application of the concept and assessment of its performance in a large timber beam.



3. DEVELOPMENT, DESIGN & FABRICATION

3.1 Beam section

A timber-plywood box arrangement was adopted. The flanges were vertically laminated uniform quality Douglas fir, the webs birch plywood, Fig. 2. The relative sizes of the beam and stressing system were chosen so that, on the basis of elastic theory, permissible stresses in the timber at transfer determined the energising forces when no dead load other than self-weight was present.

3.2 Stressing system geometry

The arrangement used was similar to Fig. 1(d) except that reverse curvature was employed towards the end of the tensioned cable, Fig. 2. This simplified the operation of the end stressing units which applied force simultaneously to tensioned and compressed wires and incorporated anchoring devices.

3.3 Compressed cable form

Concern to limit force loss due to friction on compressed cables had a strong influence on energising system development. Compression is alien to the nature of steel wires but their large strength/area ratio is desirable. The cable form used, Fig. 3, consisted of steel prestress wires inside a commercial square mild steel tube. Clearance is necessary to assemble the cable, and restrained buckling of wires occurs which develops friction forces at contact with the sheath wall. This configuration was adopted following friction tests on cables 25 m long. An expression was derived [5] relating force loss to cable length and stress level; in contrast to the conventional tension case where force loss is a function of length only. Three cables were

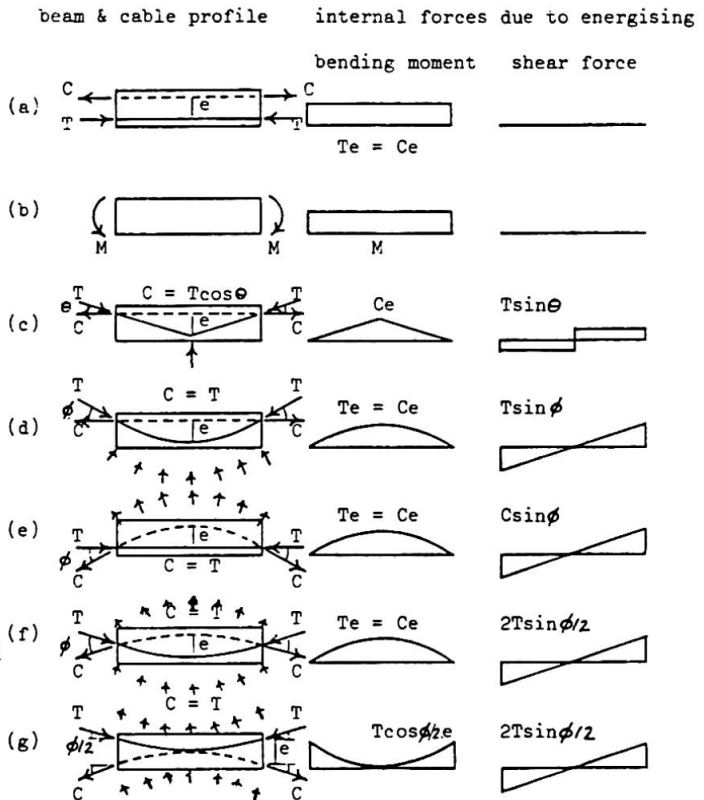

Fig. 1 Application of flexure to beams

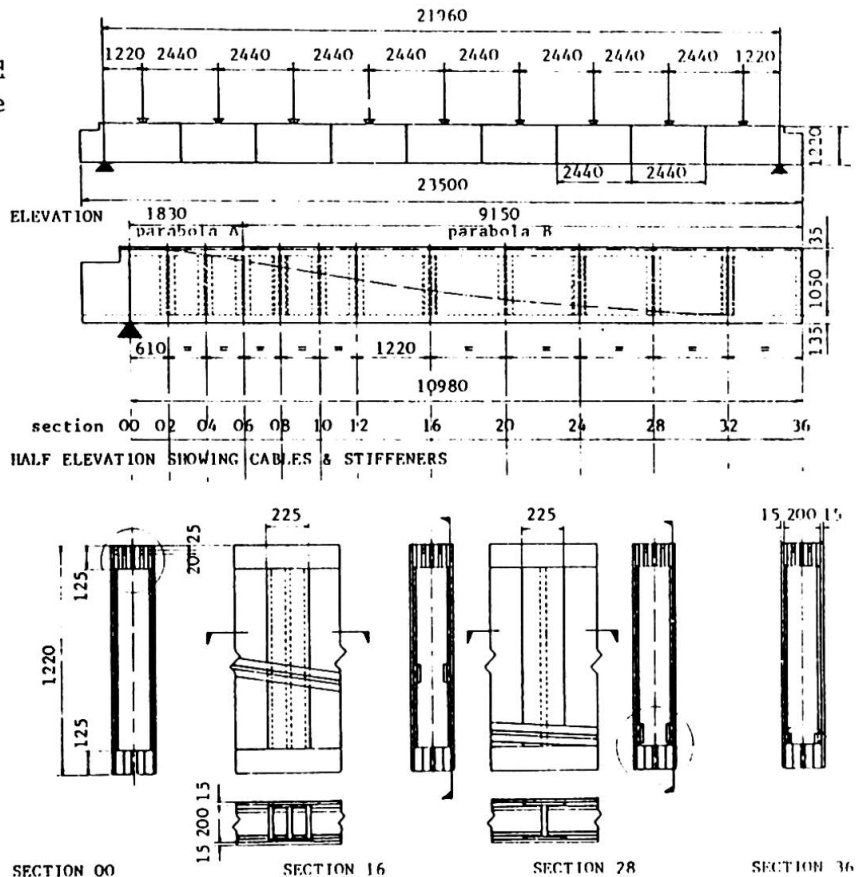

Fig. 2 General arrangement of beam and stressing system

installed in the laminations of the beam upper flange at appropriate stages during fabrication: these were balanced by two similar profiled tensioned cables, Fig. 2.

#### 4. TESTING AND INTERPRETATION OF RESULTS

The arrangement of testing rig and stabilising system is shown in Fig. 4 (plate). The behaviour of the timber beam was established and used to assess the performance of the energising system at transfer stage and under external load.

Finally the beam, in combination with fully loaded energising system, was tested to destruction. The external load was applied by nine hydraulic jacks simulating a uniform distribution. Load cells were developed to monitor forces in the compressed cables at ends and mid-span. Electrical resistance gauges were used to measure timber and plywood strains.

##### 4.1 Effects of energising system

Effects of the energising system were predictable. Moments derived from beam behaviour corresponded closely to the theoretical shape of the bending moment diagram, Fig. 5.

##### 4.2 Permissible and ultimate load

Fig. 6 shows in broken line an applied load/deflection plot at mid-span up to permissible stresses for the beam with unstressed unanchored cables. The solid line represents the plot for energised condition up to permissible stresses and beyond to failure.

For permissible loads the ratio of energised to unenergised condition was 2.38

A non violent collapse occurred at a total load, inclusive of self weight, equivalent to 29.7 kN/m. Deflection below a horizontal line was approximately 230 mm. Fig. 6 shows deflection from energised datum, ie, from upward cambered position.

The ratio of ultimate load to load at permissible stresses for the energised beam was 2.34

A method had been developed to predict collapse which depended on the characteristic strengths of Douglas fir and prestress wire [5]. The measured load was 12% less than that predicted.

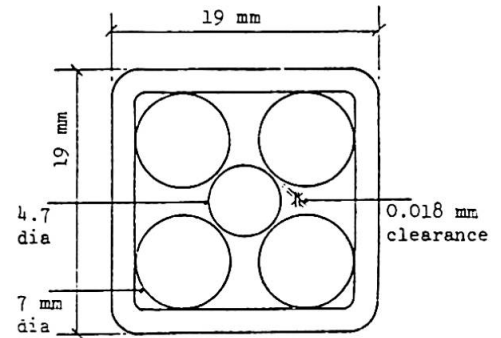

Fig. 3 Compressed cable form

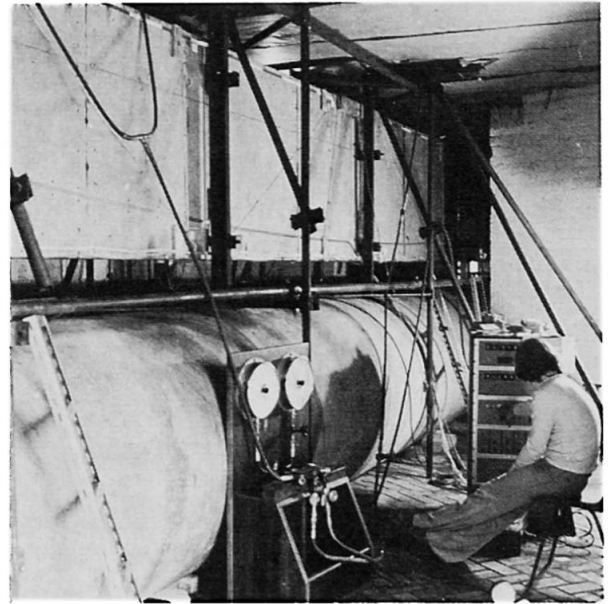

Fig. 4 (plate) Testing rig arrangement

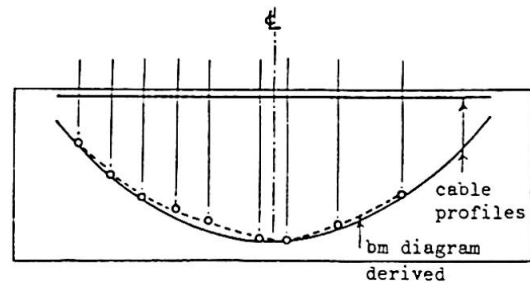

Fig. 5 Moments due to energising system

### 4.3 Friction

Maximum force loss in the compressed cables measured by load cells during energising was 9.5% from a stress of  $593 \text{ N/mm}^2$  at the ends. Since stressing was done from both ends simultaneously this represents a loss over a length of 11 m.

When an external load was applied to the beam with the energising system installed and anchored, additional cable forces were induced. Friction produced an intermediate condition between a bonded and free cable. Approaching collapse the mid-span load cells indicated a stress of  $1000 \text{ N/mm}^2$  representing an induced stress of some  $460 \text{ N/mm}^2$ .

### 5. POSSIBLE DEVELOPMENTS

In the context of increasing the span dimension, friction test results indicate that friction force loss would not be prohibitive up to spans of 50 m and beyond for wire stress levels lower than  $1000 \text{ N/mm}^2$ . By making simplifying realistic assumptions, the strength and stiffness possibilities for postflexed timber box beams manufactured from 1220 mm and 1524 mm deep standard plywood sheets have been forecast. Fig. 7 displays the span/load relationships in three pairs of graphs.

As an example a 45 m span plain timber beam 1524 mm deep with  $32250 \text{ mm}^2$  of flange is capable of permissible load of  $2.0 \text{ kN/m}$ , curve (a). By comparison a similar beam postflexed with three cables in each flange and no external load present during stressing will support  $4.0 \text{ kN/m}$ , curve (b). If dead, assumed equal to applied load as a typical practical condition acts during stressing the total permissible load capacity rises to  $8.0 \text{ kN/m}$ , curve (c). In this case the dead load is carried on the wire system the cables increasing to 8 in each flange. The application of an arbitrary deflection limitation based on deflection below a horizontal line not exceeding span/240 is shown in Fig. 7. Using this approach the critical span for the 1524 deep beam is 50.9 m.

### 6. CONCLUSIONS

The performance of the large scale energising system was very successful. It was predictably consistent and trouble free in operation. On a permissible stress basis the load carrying capacity of the timber beam was increased by a ratio of 2.38 and would have been further improved had external dead load been present.

The five wire/sheath compressed cable form proved satisfactory and could be used in groups for larger scale systems.

The investigation described sought to examine the important question as to whether the technique could be applied to the design of structural elements having the size of expected commercial applications. It is considered that this has been answered positively. Information and

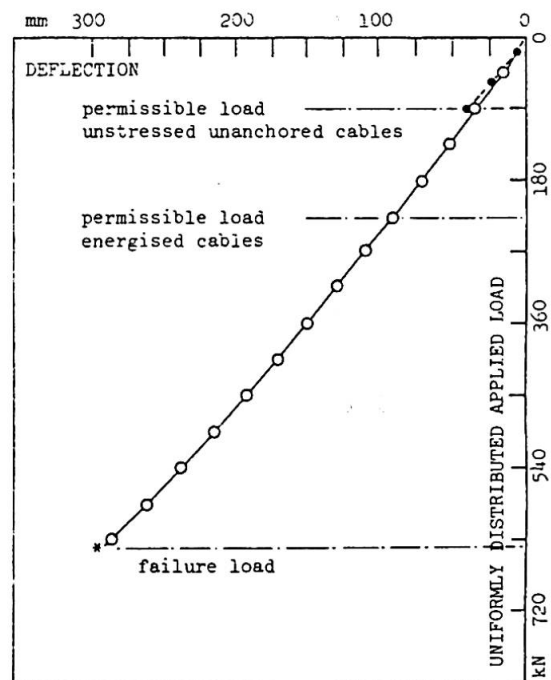

Fig. 6 Load/deflection at mid-span





experience have been gained which may be applied with confidence to further development and practical application of the technique.

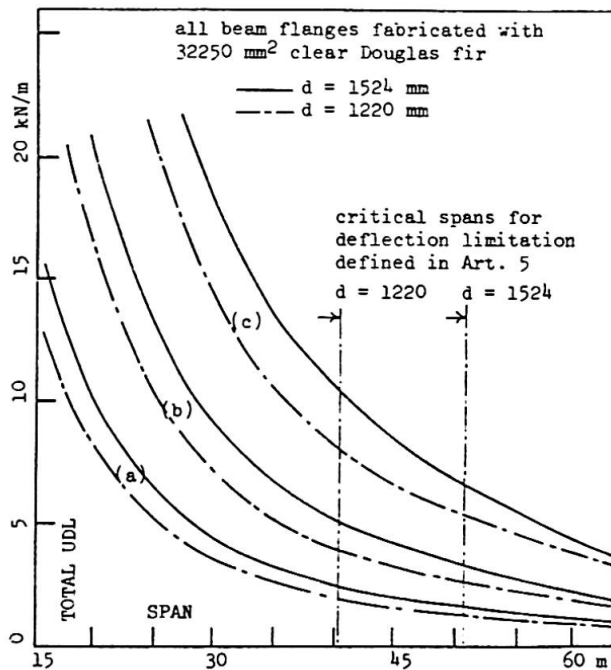

Fig. 7 Load/span relationships for simply supported timber box beams 1220 mm & 1524 mm deep subject to uniformly distributed load

- curves (a) plain timber
- curves (b) postflexed with no external load present during stressing
- curves (c) postflexed with dead load assumed equal to applied load present during stressing

#### REFERENCES

1. FREYSSINET, E. "The birth of prestressing". Travaux, 1954, trans by A.J. Harris (Cement and Concrete Association library translation no. 59) London, Cement and Concrete Association.
2. BOHANNAN, W. "Prestressing wood members". U.S. Forest Products Journal, vol. 12, no. 12, Dec. 1962. pp. 596-602.
3. LANTOS, G. "Reinforced and post-tensioned glued laminated beams under development at TRADA laboratories". Civil Engineering and Public Works Review, vol. 59, Jan. 1964. pp. 86-87.
4. NEEDHAM, F.H. "Development and use of prestressed steel flexural members". Discussion. American Society of Civil Engineers, Structural Division, vol. 95, no. ST4, April 1969. p. 1377.
5. GILFILLAN, J.R. A new prestressing concept applied to a 72 feet span timber box beam. Ph.D. thesis, Faculty of Applied Science and Technology, Queen's University, Belfast, 1978.

**II****Light Sandwich Components Based on Mineral Wool**

Eléments légers en sandwich avec noyau en laine minérale

Leichte Sandwichbauelemente mit Kern aus Mineralwolle

**KNUD PREBENSEN**

Cowiconsult,  
Consulting Engineers and Planners AS  
Copenhagen, Denmark

**TOMMY BUNCH-NIELSEN**

Cowiconsult,  
Consulting Engineers and Planners AS  
Copenhagen, Denmark

**SUMMARY**

The paper describes the elaborate testing of a light sandwich component produced by glueing plywood or other sheet materials to a core of mineral wool. The following characteristics have been investigated: Structural performance, reaction to humidity, fire and sound and to economy and production. The testings have proved that the components are suitable for use as load bearing components in one and two storey buildings in Denmark.

**RESUME**

Ce rapport décrit les essais intensifs effectués sur un élément de construction léger, de type sandwich, et obtenu en collant du contre-plaqué ou tout autre matériau similaire à un noyau de laine minérale. Les propriétés, suivantes de l'élément ont été examinées: résistance et rigidité, résistance à l'humidité et au feu, isolation etc. Il peut être utilisé comme élément porteur dans les bâtiments n'excédant pas deux étages.

**ZUSAMMENFASSUNG**

Diese Arbeit beschreibt die intensive Erprobung eines leichten Bauelementes in Sandwichbauweise, bestehend aus aussenliegenden Sperrholzplatten (oder Platten aus anderem Material) mit zwischenliegendem eingeleimtem Kern aus kantgestellter Mineralwolle. Folgende Eigenschaften dieses Elements wurden untersucht: Tragfähigkeit, Steifigkeit, feuchtigkeitstechnische, brandtechnische, schalltechnische Eigenschaften etc. Die Bauelemente eignen sich für ein- und zweistöckige Gebäude.



## 1. INTRODUCTION

The report describes the elaborate performance testing of a light sandwich component produced by gluing plywood or other sheet material to a core of mineral wool.

The purpose of the testing is to study the components' performance when used as wall, floor and roof components in low rise buildings.

The skins of the component are Douglas Fir Plywood, scarf jointed where components longer than approx. 2.5 m are required. The core consists of mineral wool, of for instance coarse glass-wool or Rockwool lamellae with a density of 50 kg/m<sup>3</sup>. The fibre direction is oriented perpendicular to the face of the component. The skins are glued to the core with a one-component polyurethane glue.

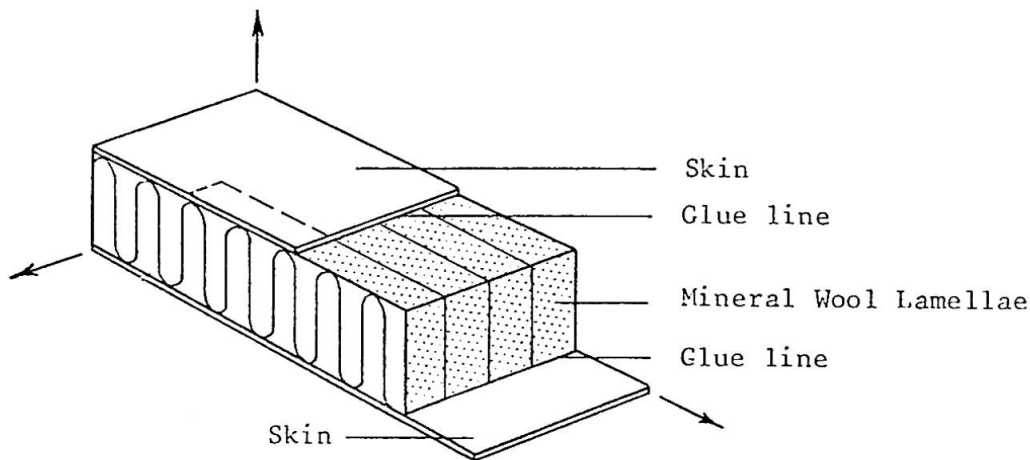

## 2. PROGRAMME

The main subjects for the performance tests are:

- Structural performance
- Climate shield (heat, rain and moisture)
- Reaction to fire (fire resistance, flame spread, etc.)
- Acoustic performance, and
- Economy and production.

### 2.1 Structural performance

In the floor- and roof-components the bending moments are transmitted by the skins, and the shear forces mainly by the core. It is, therefore, essential that the core materials provide sufficient shear strength.

In the wall components, mainly exposed to normal forces, the skins transmit the normal force, and the core has to be sufficiently rigid to prevent buckling of the skins.

The following has been examined:

- Mechanical properties of core and skin materials
- Mechanical properties of glued joints
- Long and short time reaction to lateral and axial loads.

The structural tests have been carried out at the Technical University of Denmark as follows:

#### Material tests

- Compressive and tensile stress-strain-tests of plywood
- Compressive, tensile and shear stress-strain-tests of mineral wool
- Shear and tensile strength tests of glued joints.

Mineral wool	Compression		Tension		Shear		
	Density $\text{kg/m}^3$	Strength $\sigma_c \text{ kN/m}^2$	E-modulus $E_c \text{ kN/m}^2$	Strength $\sigma_t \text{ kN/m}^2$	E-modulus $E_t \text{ kN/m}^2$	Strength $\tau \text{ kN/m}^2$	G-modulus $G \text{ kN/m}^2$
MW 50		135 (12%)	13850(12%)	54 (17%)	5250(19%)	62 ( 6%)	4740(12%)
MW 70		196 (22%)	22960(29%)	82 (17%)	5840(12%)	82 (10%)	7500(21%)
MW 90		300 (16%)	35700(17%)	156 (35%)	16650(33%)	124 (14%)	11920(14%)

Strength and modulus of elasticity.

Each figure is the mean of 10 tests, figures in ( ) are variation.

#### Full-Scale Tests of Components

- 64 short term load tests with floor- and roof-components
- 32 long term load-deflection tests with floor- and roof-components
- 33 short term load tests with wall components.

In the short term load tests the floor- and roof-components were 4 m long, 0.6 m wide and there were no edge web-plates in the span direction

Several parameters such as core thickness and the density of mineral wool were varied. Tests with skins of 12 mm plywood and core of 300 mm glass wool gave the following results:

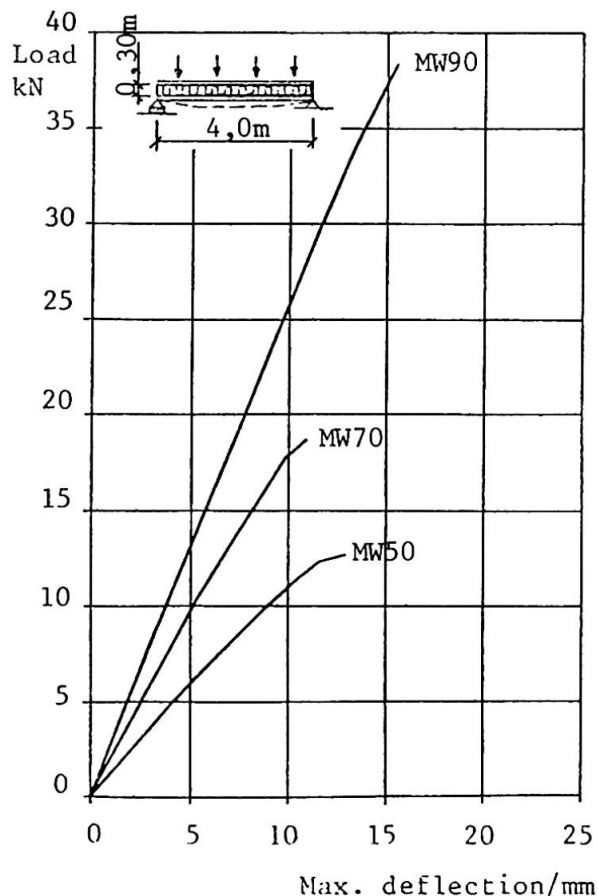

Failure occurred as shear failure between skin and core close to the supports.

The long term load tests with floor- and roof-components were continued over one year and showed small time depending deflection.

The results of 4 tests can be seen in the graph below. Test conditions were: 50 per cent of ultimate load, 20°C and 65% RH.

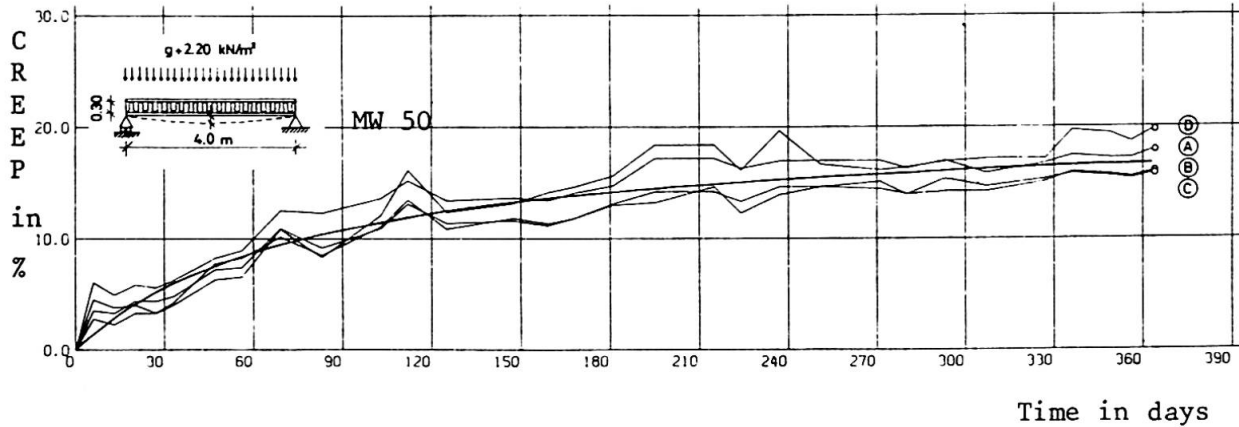

In the short term load tests with centrally and excentrically loaded wall-components these were 2.4 m high and 1.2 m wide. The components had no web-plates. In the tests with 20 cm thick wall-components the following results were found:

Load capacity for centrally and excentrically loaded walls  
Core: MW 80  
Skins: Douglas Fir Plywood

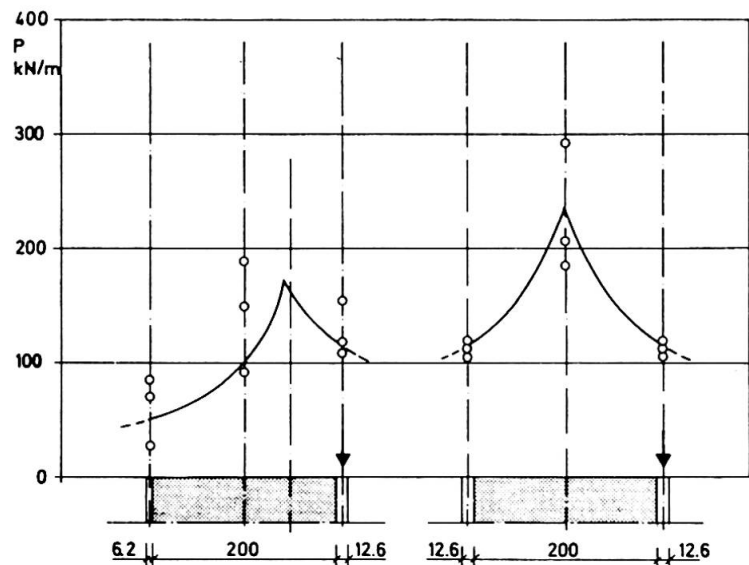

The tests showed that the components have sufficient strength to be used for loadbearing construction in one- and two-storey buildings.

## 2.2 Climate Shield

### Insulation

According to the standard thickness of the insulation, the following U-values were obtained (calculated and verified through tests in a guarded hotbox at the Technical Institute, Copenhagen).

- 145 mm = U-value of 0.26 W/m<sup>2</sup>°C
- 195 mm = U-value of 0.21 W/m<sup>2</sup>°C
- 235 mm = U-value of 0.18 W/m<sup>2</sup>°C
- 295 mm = U-value of 0.14 W/m<sup>2</sup>°C

### Humidity

Long-term tests have been carried out at the Danish Building Research Institute and a number of buildings with sandwich-components have been observed over a two year-period to study their reactions to the natural climate.

The following has been registered:

- Humidity properties of the skin materials
- Humidity accumulation in wall-components
- Humidity accumulation in roof-components
- Deflection due to asymmetrical humidity.

Humidity accumulation in components without a vapour-barrier have been investigated, and the result is, that both wall- and roof-components can be used under Danish climate conditions when the relative humidity is less than 40-50 percent at a temperature of 20-22°C in the buildings.

Special caution must be taken when using roof-components with asphalt roofing felt directly on the top skin. This prevents the humidity from escaping the construction.

If the interior climate has a higher humidity than indicated above a plywood with a build-in vapour-barrier must be used on the warm side of the component.

If the components are subjected to varying climatic conditions, especially changing humidity, it is necessary to take into account a reduction in the strength of the joint between core and skin. This is illustrated in the figure below:

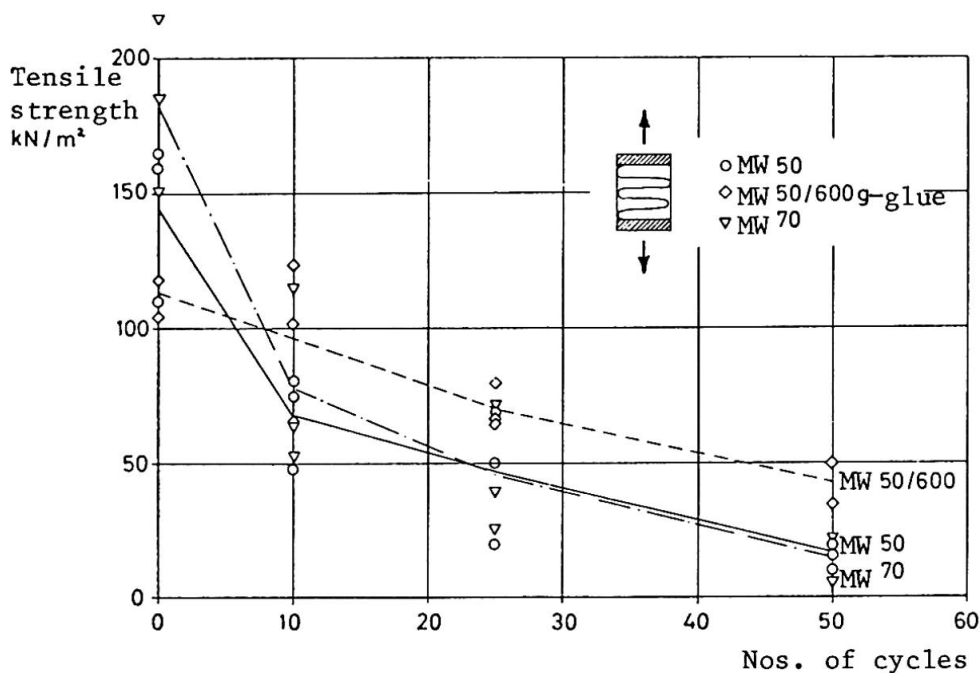



### 2.3 Fire

The Fire testing of the roof- and wall-components, including joints has shown sufficient residual load capacity to classify the components as BD 30. This means that the components under load can resist a standard fire for 30 minutes.

Components classified as BD 30 may be used as load bearing components in most one- and two-storey buildings in Denmark.

The components can also be produced with plywood skins impregnated with fire retarding chemicals, which will prevent the spread of flame.

### 2.4 Acoustics

The sound insulation of the components has been tested according to ISO/R 717 at the Acoustical Laboratory, The Technical University of Denmark, for noise abatement. A component with 300 mm core of mineral wool and skins of 12 mm plywood has a sound insulation of  $I_a \sim 30-35$  dB.

### 2.5 Economy and production

#### Easy-to-Erect

The small components can in many cases be erected without the use of a crane. Depending on the skin material and the thickness of the components, the weight is 25-50 kg/m<sup>2</sup>.

#### Flexibility

The cheapest production price is obtained by using standard sizes of the skin material, but components may be produced according to individual requirements. Components up to a length of 600 cm can be produced by scarf jointing the plywood.

Windows and doors can be incorporated in the components. Shaping can take place at the building site by using a saw.

#### Economical Production

The simple structure of the component allows for an economical mass-production which makes the component competitive in both price and quality; especially considering its strength, easy erection and excellent insulation characteristics.

## 3. REFERENCES

- Danmarks Tekniske Højskole, IFH-Rapport nr. 132: Mineraluldbaserede sandwichelementer. Hovedrapport. 1978. English Summary.
- Danmarks Tekniske Højskole, IFH-Rapport nr. 126: Mineraluldbaserede sandwichelementer. Vægelementer under brandpåvirkning. 1978. English Summary.
- Danmarks Tekniske Højskole, IFH-Rapport nr. 129: Mineraluldbaserede sandwichelementer. Bøjningsforsøg med korttidslast og langtidslast. 1978. English Summary.
- Statens Byggeforskningsinstitut, Rapport nr. 114: Mineraluldbaserede sandwichelementer. Laboratorieforsøg til bedømmelse af de fugttekniske egenskaber. 1978. English Summary.
- Statens Byggeforskningsinstitut, Rapport nr. 115: Mineraluldbaserede sandwichelementer. Fugtphobning i væg- og tagelementer udsat for det naturlige klima. 1978. English Summary.
- Publication from Cowiconsult, Consulting Engineers and Planners, No. 317: Mineraluldbaserede sandwichelementer. Byggeteknik. 1978. English Summary.

## II

**Strength of Solid and Built-Up Timber Compression Members**

La résistance des colonnes massives et composées en bois

Tragfähigkeit von massiven und zusammengesetzten Holzstützen

**S.K. MALHOTRA**

Assoc. Prof. of Civil Engineering

Nova Scotia Technical College

Halifax, N.S., Canada

**SUMMARY**

Mathematical models for the behavior of solid and built-up timber compression members are developed. These models are verified by an extensive experimental program. The results of this investigation are discussed in relation to current design practice and codes on timber columns. A rational approach to the analysis and design of timber compression members is outlined.

**RESUME**

Des modèles mathématiques concernant le comportement des colonnes massives et composées en bois sont développés. Ces modèles sont vérifiés par un programme expérimental détaillé. Les résultats de cette investigation sont discutés et comparés avec les méthodes actuelles de dimensionnement, ainsi que les normes s'y rapportant. Une méthode rationnelle par l'analyse et le dimensionnement de ces colonnes est esquissée.

**ZUSAMMENFASSUNG**

Mathematische Modelle zur Beschreibung des Tragverhaltens massiver und zusammengesetzter Stützen aus Holz werden entwickelt. Diese Modelle wurden durch ein ausführliches Versuchsprogramm überprüft. Die Ergebnisse werden mit der heutigen Konstruktionspraxis und den geltenden Vorschriften verglichen. Zum Schluss werden praktische Möglichkeiten zur Berechnung und zur Bemessung von Holzstützen aufgezeigt.





## 1. INTRODUCTION

Compression members commonly referred to as "columns", if they are slender enough, fail by buckling either before or after the elastic limit has been reached depending on the proportions of the column. The behavior and design of timber columns have been the subject of research for many years. Some of the research literature on the subject is listed in the references. Despite the continued research effort, the basic column problem is still not fully understood and the current design methods for solid timber columns are based on empirical formulas [2, 10]. Furthermore, there is very little guidance given for the design of built-up columns in the codes and specifications on timber design [2, 10].

In recent years, the author has been engaged in a number of projects related to solid and built-up timber columns, carried out at Nova Scotia Technical College [4 to 9, 14]. This paper outlines the highlights of these investigations. Detailed information on various aspects of the research can be obtained from the pertinent references listed at the end of the paper. The main objectives of this research have been to study the behavior of and develop a rational approach for the analysis and design of solid and built-up columns. The results are also discussed in relation to the current specifications and code stipulations on timber columns. A unified, design procedure is developed for columns in the elastic and inelastic ranges of stress. The types of timber columns included in the investigations are: solid, layered, spaced, braced and box columns.

The problem of a column is treated as a problem in stability. The theoretical development assumes a pure, axially loaded column, that is, a column which is centrally loaded by a compressive force whose resultant at each end coincides with its longitudinal axis. Although the concept of a pure column is an idealization in actual situation, it is a fundamental case in the study of behavior of columns in broad sense and is generally considered as the basis for the design of centrally loaded columns. Bending moments resulting from an unintentional end eccentricity, due to factors such as non-homogeneity of the material, imperfection in fabrication, initial curvature, etc., will reduce the strength of a column that is intended to be centrally loaded. However these effects should be accounted for by an appropriate factor of safety in design formulas. If the bending moment is caused by an intentional end eccentricity, rotation of adjacent members, or lateral loads, the problem then falls into the classification of beam-columns which is beyond the scope of this paper.

## 2. RATIONAL PROCEDURE FOR ANALYSIS AND DESIGN

The tangent-modulus concept is extended for predicting the strength of solid as well as built-up timber columns [4, 6]. The column formula can be written as:

$$F_{cr} = \frac{\pi^2 E_t}{\lambda^2} B \quad (1)$$

where:  $E_t$  = tangent modulus = slope of the stress-strain curve at a particular stress level;  $F_{cr}$  = column buckling stress;  $\lambda$  = slenderness ratio of the column;  $B$  = a factor which accounts for the column configuration and effect on non-rigidity of connections in built-up columns. For solid columns,  $B = 1$ . The expressions for  $B$  values for different types of built-up columns--layered, spaced, braced and box--are given in [6, 8, 9, 14].

To elucidate the column buckling problem in the inelastic range, a function proposed by Ylinen [15] is adopted in the present research. The function contains three parameters:  $F_u$  = ultimate compressive stress;  $E$  = modulus of elasticity; and  $c$  = a constant depending on  $F_u, E$  and the shape of the curve beyond the limit of proportionality. The shape of the stress-strain curve according to this function can be seen in Fig. 1. The function is a very good approximation to the experimental stress-strain curves for wood [4], and is well suited to the analysis of buckling problems as the value of  $E_t$  corresponding to it can be expressed in a simple form, Fig. 1. Introducing  $E_t$  value derived from this function into Eq. 1 results in the following solution for column buckling stress:

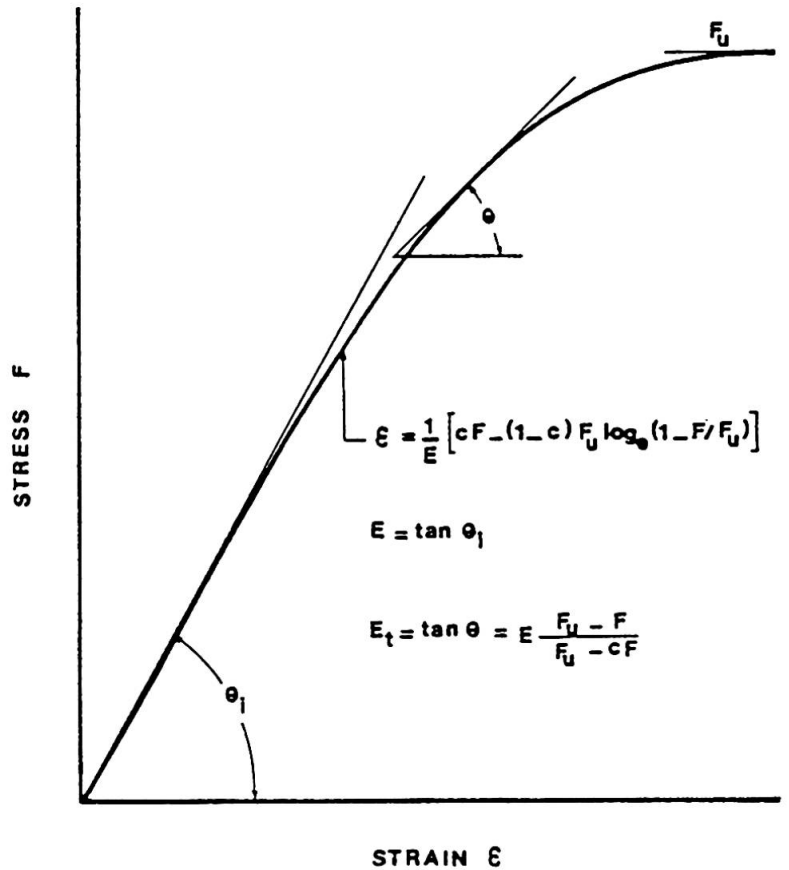

Fig. 1 Stress-Strain Curve

$$F_{cr} = \frac{B\pi^2 E + F_u \lambda^2}{2c\lambda^2} - \frac{\sqrt{(B\pi^2 E + F_u \lambda^2)^2 - 4Bc\lambda^2 \pi^2 E F_u}}{2c\lambda^2} \tag{2}$$

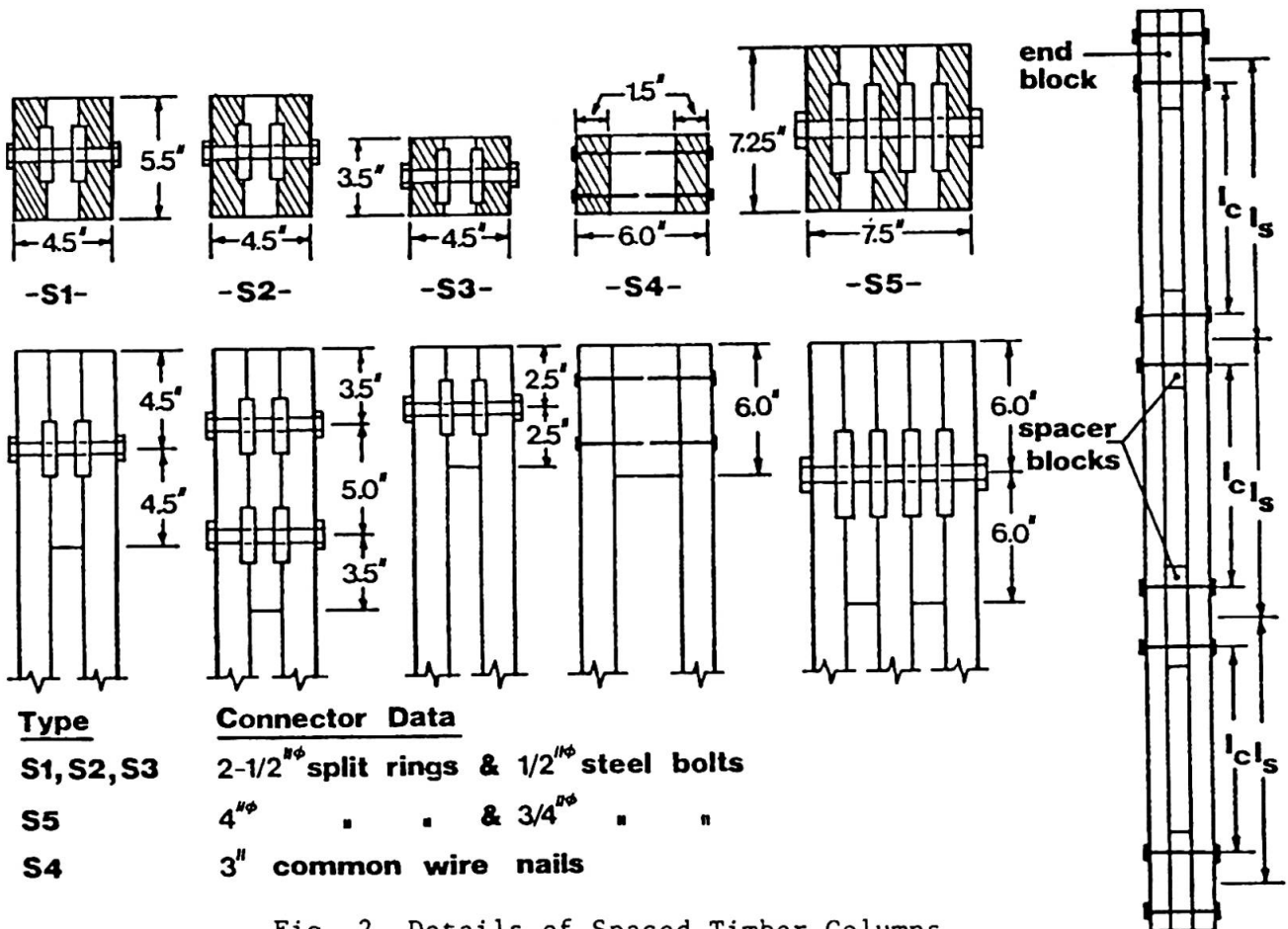

Fig. 2 Details of Spaced Timber Columns

Theoretical predictions by Eq. 2 were compared with the experimental data obtained from many series of tests on solid and built-up timber columns. Some 1200 columns of eastern spruce were tested in total. As an illustration, Fig. 2 is given here to show types of spaced columns that were investigated. Good agreement was observed between the theoretical and experimental results for all series of tests.

The use of Eq. 2 makes the column buckling problem rational and limits empiricism to an absolute minimum. However, this equation is inconvenient to use directly in design. If a specific value is assigned to 'c', curves can be plotted between the two dimensionless quantities  $F_{cr}/F_u$  and  $\lambda$  for various values of factor  $F_u/EB$ . The curves between these two quantities for eastern spruce lumber can be seen in Fig. 3. The value of parameter c for eastern spruce is taken equal to 0.90 as was found by compression tests. The ratio  $F_{cr}/F_u$  is referred to as the 'buckling coefficient' and is denoted by  $\beta_3$ . In Fig. 3,  $\beta_3$  is plotted against  $\lambda$  for  $F_u/EB$  values ranging from  $1.00 \times 10^{-3}$  to  $18.00 \times 10^{-3}$ . The experimental values of the ratio  $F_u/EB$  encountered in the present research were well within the range. As a comprehensive aid for design, graphs like Fig. 3 can be plotted for a wide range of  $F_u/EB$  values. With the aid of such graphs, the critical column stress,  $F_{cr}$ , in a given column can be calculated quite easily. To determine the allowable column stress,  $F_u$  and E should be replaced, in all calculations, by the allowable compressive parallel to grain stress and design value for modulus of elasticity of column material.

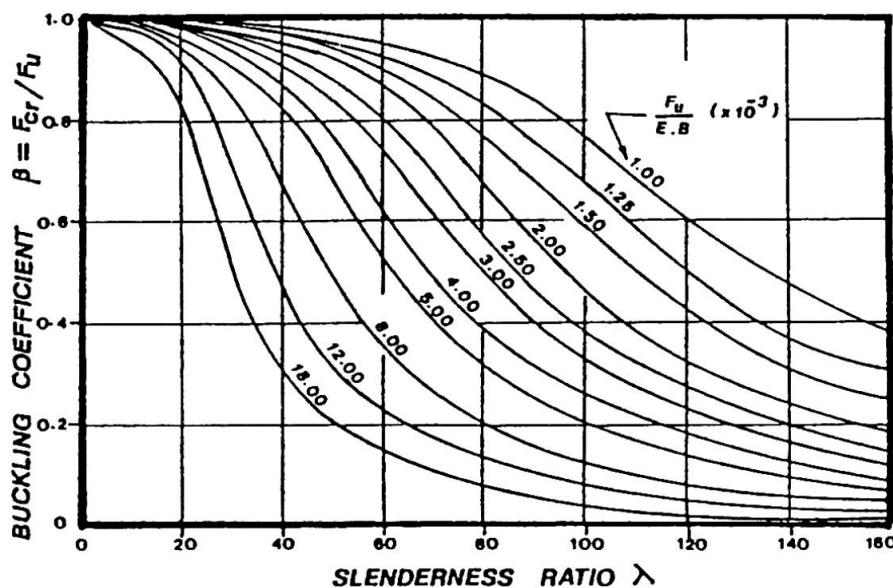

Fig. 3 Buckling Coefficient Versus Slenderness Ratio Curves

### 3. EFFICIENCY OF BUILT-UP COLUMNS

Comparison is made of the efficiency of various types of built-up timber columns fabricated with different types and sizes of connectors and with different spacings of connectors. Figure 4 shows efficiency curves for different bolt spacings in the type of layered column cross-section sketched on the figure. Efficiency is defined as the ratio of the strength of a laminated column to the strength of equivalent solid column of same overall dimensions as those of the laminated column. Graphs of the type shown in Fig. 4 can be valuable design aid to designers in selecting an efficient combination of lumber sizes and connector spacings.

Though there is hardly a mention of braced and layered columns in current codes and specifications, there is a procedure given for the design of specific type of spaced timber columns built with spilt ring connectors [2, 10]. In light of the experimental results of the investigation on spaced columns, this design procedure seems to be based on a very conservative estimate of spaced column strength.

#### 4. CONCLUSIONS

Based on theoretical and experimental studies, a rational approach to the analysis and design of solid and built-up timber columns is presented. This procedure is valid for all slenderness ratios and is, thus, applicable to columns in the elastic and inelastic ranges of stress. It can be used to determine critical or allowable column stresses. Efficiency of various types of built-up columns is compared and the effect of connector spacing on the column strength is investigated.

Research is continuing to cover timber members subjected to combined axial and bending loads. The effects of end restraints on the strength of timber compression members will be included in the investigation.

#### 5. ACKNOWLEDGEMENTS

The author wishes to acknowledge the financial support provided by the National Research Council and Natural Sciences and Engineering Research Council of Canada for various projects discussed in this paper. Thanks are extended to Dr. D.B. Van Dyer for his cooperation and contribution in the investigations on built-up columns, and to Dr. G.G. Meyerhof and Mr. A. Ritchie for their valuable suggestions and assistance. Appreciation is also due to Mrs. Anita Malhotra for the meticulous typing of this manuscript.

#### REFERENCES

1. BURGESS, H.J. "A Mathematical Basis for Design Aids for Timber Columns", 6th Meeting of CIB Working Commission W18-Timber Structures, Aalborg, Denmark, 1976.
2. CANADIAN STANDARDS ASSOCIATION (CSA). "Code for the Engineering Design of Wood, CSA Standard O86", CSA, Rexdale, Canada, 1976.
3. LARSEN, H.J. "Design of Solid Timber Columns", 5th Meeting of CIB Working Commission W18-Timber Structures, Karlsruhe, W. Germany, 1975.
4. MALHOTRA, S.K. and MAZUR, S.J. "Buckling Strength of Solid Timber Columns", Transactions of Engineering Institute of Canada, Published in Engineering Journal, Vol. 13, No. A-4, 1970.

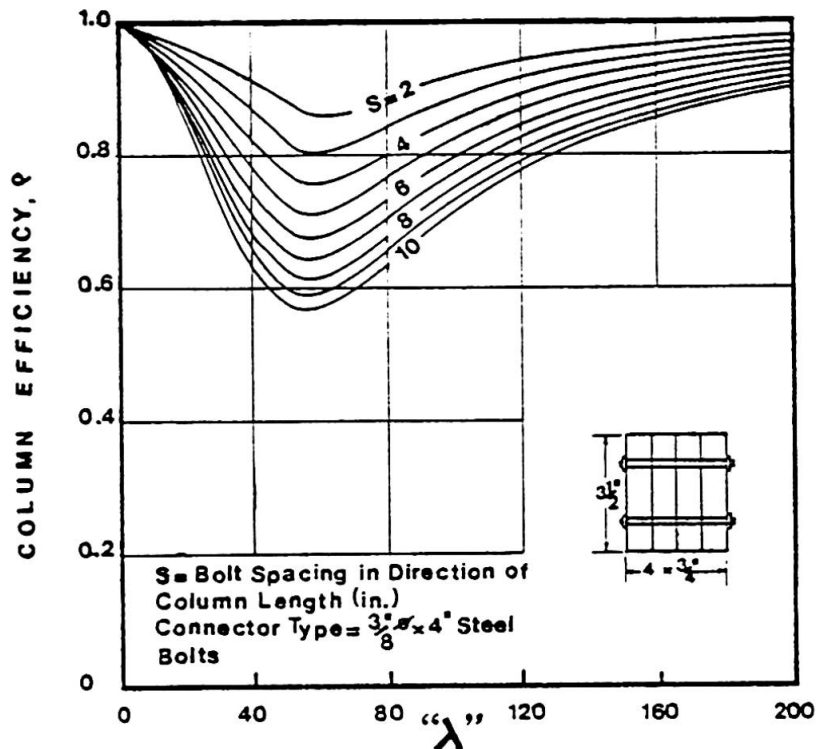

Fig. 4 Efficiency Curves for Layered Columns With Various Bolt Spacings

5. MALHOTRA, S.K. "A Rational Approach to the Design of Solid Timber Columns", Applications of Solid Mechanics - Study No. 7, Published by University of Waterloo, Waterloo, Canada, 1972.
6. MALHOTRA, S.K. and VAN DYER, D.B. "Rational Approach to the Design of Built-Up Timber Columns", Wood Science, Vol. 9, No. 4, 1977.
7. MALHOTRA, S.K. and VAN DYER, D.B. "A Computerized Approach to the Analysis and Design of Mechanically Connected Timber Columns", Proceedings of International Conference on Computer Applications in Developing Countries, Bangkok, Thailand, 1977.
8. MALHOTRA, S.K. and VAN DYER, D.B. "Analysis and Design of Spaced Timber Columns", Proceedings of Annual Congress of Canadian Society for Civil Engineering, Montreal, Canada, 1979.
9. MALHOTRA, S.K. AND VAN DYER, D.B. "Buckling Strength and Efficiency of Timber Box Columns", 16th Midwestern Mechanics Conference, Manhattan, Kansas, USA, 1979.
10. NATIONAL FOREST PRODUCTS ASSOCIATION (NFPA). "National Design Specification for Wood Construction", NFPA, Washington, D.C., USA, 1977.
11. NEUBAUER, L.W. "A Realistic and Continuous Wood Column Formula", Forest Products Journal, Vol. 23, No. 3, 1973.
12. NISKANEN, E. "Investigation of the Buckling of Compressed Columns Assembled by Nailing", Publication 63, The State University of Technical Research, Helsinki, Finland, 1961.
13. RASSAM, H.Y. and GOODMAN, J.R. "Buckling Behavior of Layered Wood Columns", Wood Science, Vol. 2, No. 4, 1970.
14. VAN DYER, D.B. and MALHOTRA, S.K. "Buckling Strength of Braced Timber Columns", 7th Canadian Congress of Applied Mechanics, Sherbrooke, Canada, 1979.
15. YLINEN, A. "A New Method of Determining the Buckling Stress and The Required Cross-Sectional Area for Centrally Loaded Straight Columns in Elastic and Inelastic Range", Publication IABSE, 1956.

## II

**Racking Tests of Nailed Walls of Timber and Fibreboard**

Essais de cisaillement de parois formées de panneaux d'aggloméré et de contre-plaqué cloués

Schubversuche an Wandelementen mit aufgenagelten Sperrholz- und Faserplatten

**B. EDLUND**

Associate Professor

Chalmers University of Technology

Göteborg, Sweden

**SUMMARY**

In the walls of modern timber houses there is a trend to utilize the shear stiffness of panels of e.g. fibreboard or plywood nailed to the timber frame. Such walls act as windbracing elements. This paper demonstrates the structural behaviour of such walls in in-plane shear and presents briefly two recent investigations in Sweden.

**RESUME**

Dans les maisons modernes en bois, on a tendance de plus en plus à utiliser la résistance au cisaillement des panneaux d'aggloméré et de contre-plaqué qui sont cloués sur l'ossature en bois. Ces panneaux sont utilisés principalement comme contreventements. Ce rapport décrit le comportement de tels éléments soumis à un effort tranchant dans leur plan; on présente encore brièvement les résultats de deux études effectuées récemment en Suède.

**ZUSAMMENFASSUNG**

Bei modernen Kleinhäusern aus Holz besteht die Tendenz, die Schubsteifigkeit von Scheiben aus Holzwerkstoffen, z.B. Holzfaserverplatten oder Sperrholz, die am Holzskelett genagelt sind, auszunützen. Solche Scheiben wirken dann als Windverbände. In diesem Beitrag wird das Tragverhalten von solchen Wänden unter Schubbelastung anhand einiger neuerer schwedischer Untersuchungen kurz beschrieben.



## 1. INTRODUCTION

The stabilization of one or two storey timber houses against wind loading may be made by separate wind bracing. A modern trend is to utilize the structural action of nailed wall panels of e. g. fibreboard or plywood instead of diagonal bracing. The panels are mainly acting in shear. In the design of walls under in-plane horizontal wind-induced loading (racking load) both the strength and stiffness of the sheared wall as well as the properties of the nailed joint are of interest.

The aim of this paper is to give the main characteristics of the shear action of load carrying thin panels nailed to a timber frame wall (also called stud wall) and to present a test series of eleven walls under racking load carried out at Chalmers University of Technology, Division of Steel and Timber Structures, Göteborg. Two larger test series comprising both walls and simple connections carried out at the Swedish Forest Products Research Laboratory (STFI), Stockholm will also be mentioned.

One main problem for the designer is the selection of a suitable nail spacing. Another is the question of how to predict the stiffness and load carrying capacity of long gable walls (maybe 5 or 6 m) consisting of several wall elements joined together and which may contain window openings. A third question is to find a suitable method to secure the bottom windward corner of the wall against uplift.

## 2. SHEAR ACTION OF WALL ELEMENT

Study a timber stud wall with panels nailed to one or both sides of the wall. The panels are usually of fibreboard or plywood, but also other boards such as chip-board or gypsum board may be used. The external load is a horizontal load at the top of the wall, Fig 1. The nailed joints of the timber frame itself are so weak that the unclad timber frame will not be considered to take any shear, but will act as a mechanism. The board panels can be regarded as rigid in shear. The flexibility of the fasteners (nails or staples) between boards and studs is usually so large that fairly large deformations will take place in these joints. Unless the nail spacing is very small, failure will occur at the fasteners. In some cases for panels with small out-of-plane bending stiffness, buckling may occur and give rise to failure.

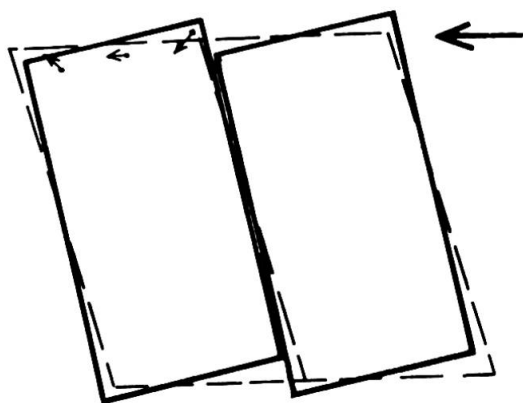

Fig.1 Wall element with two board panels loaded in shear. Schematic illustration of deformations. The small arrows show the deformation of the nails from board to timber frame.

The deformations of a typical two-panel wall in shear are shown in Fig 1. The mutual displacement between the two panels at their junction is clearly seen. If a longitudinal joint strip of plastic and paper is placed along this junction the shear stiffness of the wall will increase considerably.

### 3. TEST SERIES

#### 3.1 General

A pilot test series of eleven full-size walls under racking load has been made at Chalmers University of Technology [5]. The walls had lengths from 2.40 m to 6.60 m and were composed of prefabricated wall elements having widths 1.20 m or 0.60 m. The elements had lumber framing to which a hardboard or a low density fibreboard skin was nailed. The aim was mainly to study the stiffness of walls with different length and different types of board material (both one-sided and two-sided cladding) and to find efficient and simple methods in order to secure the wall against uplift due to the shear load. Therefore it was important to achieve realistic edge conditions especially at the bottom sill.

At the STFI in Stockholm a larger test series has been carried out on 35 walls of which 11 had openings for windows [6]. The main aim of that series was to study the stiffness and strength of wall elements with different types of panels nailed to *one* side of the wall. The walls were of short and medium length 1.20, 1.80, 2.40, and 3.60 m. The stud spacing was 600 mm. The elements were loaded in a shear testing frame which provided the artificial support forces needed for equilibrium. This series may be regarded as pure shear tests of isolated wall elements. Therefore, studies concerning edge joints and the uplift problem are outside the STFI investigation [6]. The panel types in the STFI series are medium density hardboard, low density fibre board (asfaboard), chipboard, plywood, and gypsum board (the thicknesses are the same as in section 6).

The rest of this section (§§ 3.2 and 3.3) and section 4 will deal only with the series at Chalmers University.

#### 3.2 Test specimens

As already mentioned, the basic building block for the walls tested at Chalmers is a prefabricated element in full height (2.40 m) and normally 1.20 m wide (in a few cases also 0.60 m width was used). The size of the lumber was 40x150 mm<sup>2</sup> and the spacing of the wall studs 600 mm, i. e. each normal element of width 1.20 m had three studs. Fibreboard was fastened to both sides of the timber frame - a 12 mm soft board (asfaboard) on one side and a 10 mm hardboard on the other. Staples were used as fasteners. One aim of the tests was to study the use of a more dense nailing (spacing 75 mm) than the usual minimum (100 mm). The elements were then joined together to the desired length by boards overlapping the neighbouring wall stud. These joints were also nailed with staples.

Nine walls were of size 2.40x2.40 m<sup>2</sup> (two elements joined together) and two walls were full-length gables 2.40x6.60 m<sup>2</sup>. One of the latter had a hole for a window.

#### 3.3 Testing arrangement and loading procedure

A special testing rig was built where the walls were tested in an upright position. The vertical load on top of the wall was simulated by a series of hydraulic jacks and the horizontal wind load by a larger jack (P in Fig 2). The elements were placed on a timber sill as used in practice. Different types of anchorage against uplift were tested. The type that proved to be best was a steel angle bolted to the element and the sill at A, see Fig 2.

For a discussion of different testing methods see [1].



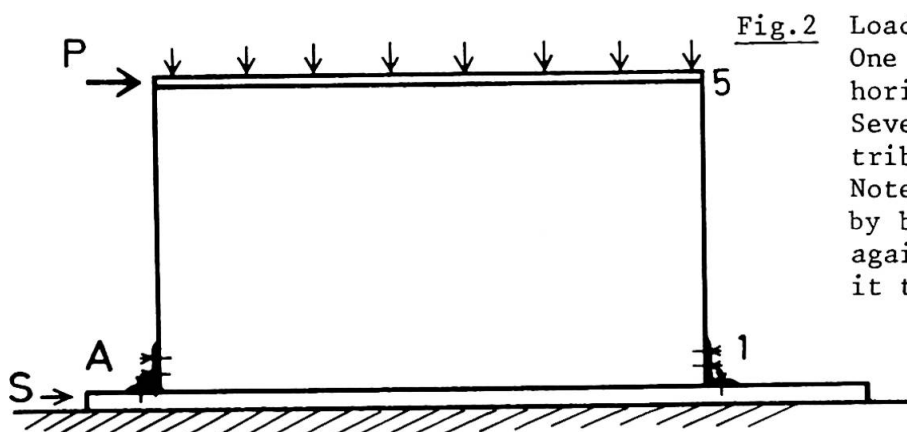

Fig.2 Loading arrangement. One large hydraulic jack for horizontal racking force P. Several small jacks for distributed vertical top load. Note steel angles attached by bolts to secure wall against uplift by anchoring it to the bottom sill (S).

The vertical load was applied with 2.15 kN on each jack (jack spacing 0.6 m) on a steel U-bar attached to the top of the wall. This load was then kept constant during the rest of each test. The friction between the jacks and the U-bar was practically eliminated by inserting Teflon discs. The horizontal load P was then applied with load levels of 2 kN, 4 kN, 6 kN etc up to 16 kN or to the maximum load if failure or excessive deformations occurred for  $P < 16$  kN. The load P was kept constant on each load level during 5 minutes, then P was diminished to 0 and kept at zero level during 5 min. Readings of dial gauges (placed horizontally and vertically at the corners) were made after each 5 minutes interval.

Each of the 2.4 m wide walls was tested twice : (a) with only two nails attaching the wall to the sill (one nail at each end), (b) with one special steel angle bolted to wall and sill as shown in Fig 2. Details of the observations during loading are given in Ref. [5].

#### 4. RESULTS OF WALL TESTS

As an example of experimental results the load-displacement curves for the upper unloaded corner of seven walls of width 2.4 m are shown in Fig 3. In this figure it is distinguished between the two cases a and b just mentioned. Normally test 'a' was made first, but for specimens 8 and 9 test b with the angle connection was made first.

The elements were in most cases loaded until some local failure occurred, usually at the fasteners. For the long element with opening, buckling of the board panel occurred near the opening which opened up the nailing row along the lower edge of the window opening.

From Fig 3 the effect of the angle (at A in Fig 2) is clearly seen. The effect of the board type is also apparent. For two walls (no 6 and no 7) the 12 mm low density fibreboard on one side of the element was replaced by 10 mm hardboard. In Fig 3 these two walls have the largest stiffness.

The horizontal displacement  $\delta_5$  is directly measured by the dial gauge. Therefore the slip that may occur along the bottom sill is included. If the horizontal displacement at the bottom corner 1 is subtracted and the result is divided by the wall height, a measure of the total wall shear, the angle  $\gamma$ , is obtained (translation removed). As there in many cases, however, is an uplift at the corner A the element will also rotate. By subtracting also this rotational angle  $\theta$  from  $\gamma$  the shear strain of the isolated wall is obtained. This  $\gamma_0 = \gamma - \theta$  is called the "actual shear strain" by Sugiyama [4].

The discussion of shear action given in section 2 indicates that, given the shear capacity of a wall with one board panel, the load carrying capacity of a

long wall with a series of board panels may be obtained by adding the shear capacity of each panel. This has also been confirmed by tests, c. f. for example [4, Fig 10].

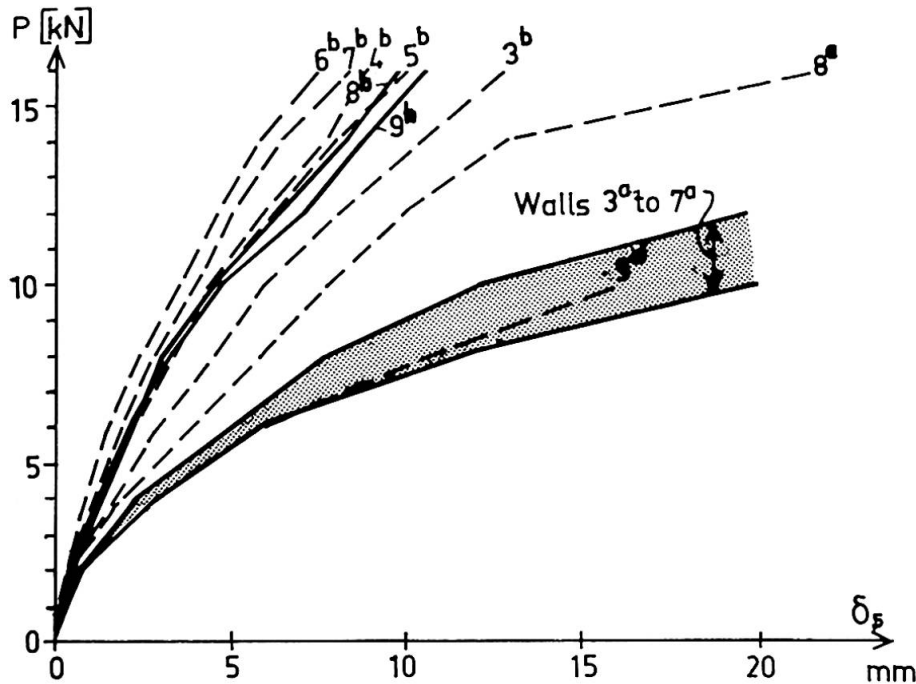

**Fig.3** Load versus measured horizontal displacement at upper unloaded corner (point 5).  
 Walls 3 to 9 with length 2.4 m. Walls 6 and 7 have 10 mm hardboard on both sides. All the other walls have 10 mm hardboard on one side and 12 mm low density fibreboard on the other side.  
 Fully drawn curves — first test  
 Dashed curves ---- second test  
 a no angle connections  
 b steel angle connections bolted at bottom corners

## 5. COMPUTATIONAL MODELS

*Simplified methods.* - Assume that both the timber elements and the panels are rigid, i e only the deformation of the fasteners is considered. Further, study only the behaviour of an isolated wall element, i e the anchoring to the foundation is left out of the discussion. Then relatively simple formulas for the stiffness and strength of nailed elements under shear load may be derived, see for example Tuomi & McCutcheon [2] and Korttesmaa [3]. In a work under way at the STFI in Stockholm [6], *Bo Källsner* has obtained the following formula for the ultimate shear load  $P_u$  (assuming fastener failure) of a wall element with three studs. The geometric parameters are defined in Fig 4.

$$(1) \quad P_u = (k_h^2 + k_v^2)^{-1/2} \cdot nQ$$

$$(2a), \quad \text{where } k_h = 6n / (6n + 2m + 4/m + p - 3 + 2/p)$$

$$(2b) \quad \text{and } k_v = 3\alpha n / (3m + n + 2/n).$$

Here  $Q$  is the load carrying capacity of one fastener in a test according to Fig 5 with  $\varphi = 0^\circ$ .

A wall consisting of  $N$  such elements will have the ultimate load  $N \cdot P_u$ .

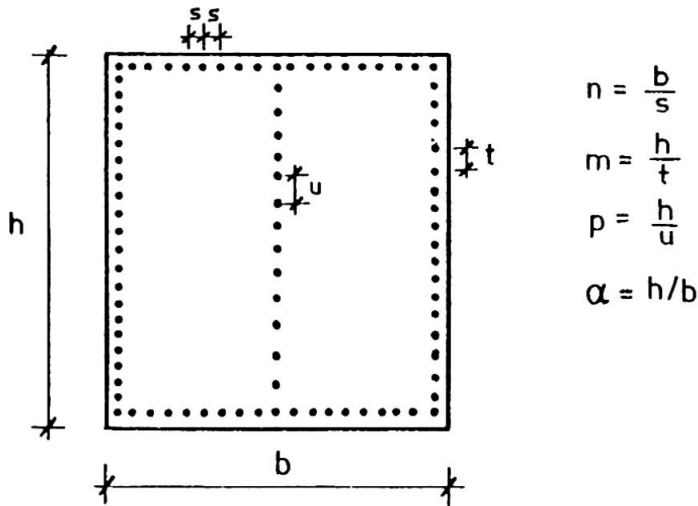

Fig. 4 Definition of non-dimensional parameters  $n$ ,  $m$ , and  $p$  for fastener spacing for a wall with three vertical studs.

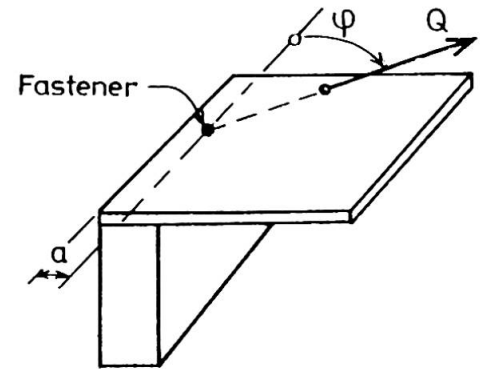

Fig. 5 Loading test of mechanical fastener joining panel and lumber.

FEM-method. - A more accurate computation will be made with the aid of a Finite Element program on a digital computer.

## 6. FASTENER CHARACTERISTICS

The load-deformation properties of a fastener joining board and lumber depend on a number of parameters such as panel material and thickness, fastener type and dimensions, edge distance  $a$ , angle of loading  $\varphi$ , Fig 5. In a systematic investigation at STFI, Stockholm [6], tests to failure were made on 700 simple joints with one fastener. The main parameters varied were (1) Edge distance  $a$ ; (2) Angle  $\varphi$  between force direction and edge of panel ( $-90^\circ < \varphi < 90^\circ$ , where  $\varphi < 0$  correspond to a compressive force  $Q$ ); (3) Panel type : asfboard 13 mm, medium density fibre board 12 mm, gypsum board 9 and 13 mm, plywood 8 mm, chipboard 12 mm; (4) Fastener type (nail, and for gypsum board nail or screw). The results are strength and stiffness of single fastener as functions of these parameters.

## ACKNOWLEDGEMENT

This paper is based on research partially supported by the Swedish Council for Building Research - for the CTH-project grant no 780993-5.

## REFERENCES

1. YANCEY, C.: The development of an improved test for evaluating the racking resistance of wall panels. NBS Building science series 91. Washington 1976.
2. TUOMI, R. - McCUTCHEON, W.: Racking Strength of Light-Frame Nailed Walls. ASCE Journal of the Structural Division 104 (1978), ST7 (July), p 1131-1140.
3. KORTESMAA, M.: Fibreboard and chipboard walls as windload bracing. (In Finnish). Rakennusteollisuus 1976, No 4, p 26-31.
4. SUGIYAMA, H.: On the racking stiffness of bearing walls of platform framing construction due to full-scale house test and ASTM racking test. Meeting of Int. Union of Forest Res. Organisations (IUFRO) Wood Engineering Group, Vancouver, Canada August 1978, Proceedings Paper 12, p 232-243.
5. BJÖRKLUND, G. - OLSSON, L. - ROSENDAHL, M.: Membrane action of windbracing wall elements of lumber and fibreboard - Experimental investigation of the stiffness of prefabricated wall elements with special reference to connections (In Swedish). M Sc Thesis, Chalmers University of Technology, Dept of Structural Engineering 1979. Unpublished.
6. KÄLLSNER, B.: Skivor som vindstabiliserande element vid träregelväggar (Panels as windbracing elements for timber stud walls. In Swedish). STFI-Report (To be published) Swedish Forest Products Research Laboratory, Stockholm.

**II****Vierendeel Trusses in Timber and Frame Design**

Poutres Vierendeel en bois et dimensionnement des cadres

Vierendeel-Träger aus Holz und Rahmenbemessung

**T.A.C.M. VAN DER PUT**

Ir.

Delft University of Technology

Delft, The Netherlands

**SUMMARY**

Tests on vierendeel girders of timber, both with glued and nailed plywood gussets, showed dimensioning conditions for indetermined constructions.

**RESUME**

On a effectué des tests sur des poutres Vierendeel en bois; les goussets en contre-plaqué cloués ou collés. Les résultats de ces essais permettent de dégager certaines règles de dimensionnement pour les éléments porteurs hyperstatiques.

**ZUSAMMENFASSUNG**

Die experimentelle Untersuchung von Rahmenträgern aus Holz mit aufgeleimten oder aufgenagelten Knotenplatten aus Sperrholz ergab Bemessungskriterien für die Konstruktion statisch unbestimmter Tragwerke.

## 1. INTRODUCTION

In the scheme of research on statically indetermined constructions, tests were carried out in 1972 on vierendeel-trusses in timber with glued plywood gussets and others with nailed gussets, to obtain information about the stiffness, creep and strength, and redistribution of forces.

Motive to test the portalform of a vierendeel beam as type of construction was among others the verification of some aspects of building design, from which it e.g. appeared, in a worked out example of an office building in timber, that only minor differences exist in force distributions between buildings with stiff- and semi stiff connections.

## 2. SOME RESULTS OF THE INVESTIGATION ON VIERENDEEL-TRUSSES

In fig. 1 the scheme of the tested girders and shape of the joints is given.

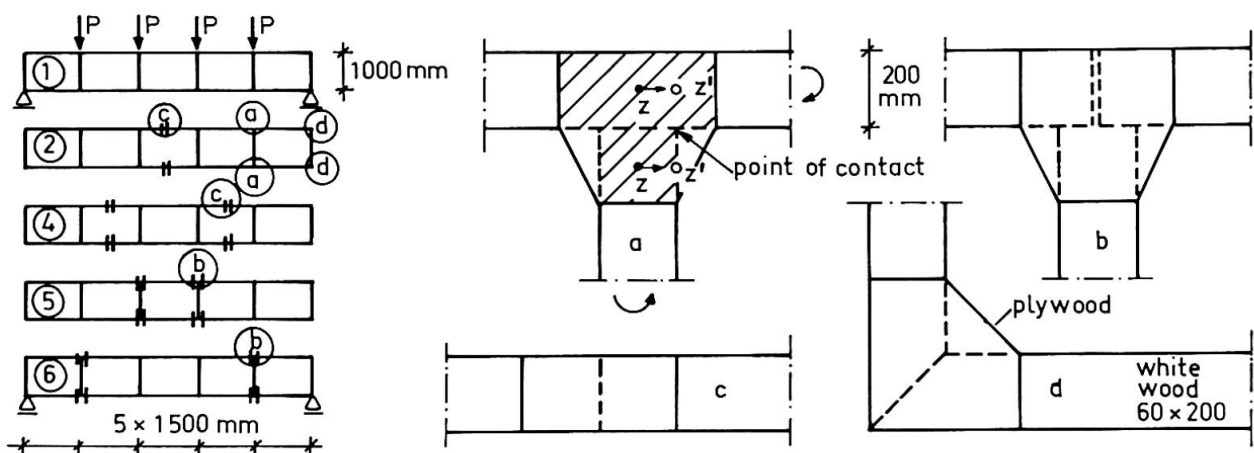

Fig. 1 Places member joints: ||, and plywood gussets.

Besides trusses with continuous horizontal members, trusses with joints in these girders on different places, low loaded (c) or high loaded (b) at the elastic stage, were tested. The loading was short-term and long-term followed by recovery periods and at last, the ultimate load test was done. The strength of the nailed connections could be explained from the mechanism of failure of the nails and the volume effects of the crushing strength of the wood. Tests on separate joints showed a highly non-linear force-deformation-diagram with a great hysteresis and even a linear approximation up to working load is dependent on the load level and load history. To account for this, a rheological model was set up, that could describe the deformations and the hysteresis by only a few parameters, leading to the loading expression of the moment  $M$  on the nail pattern of the gussets of:

$$M \approx C F_u \frac{I_p}{R} \sqrt{\frac{\psi}{\psi_m}} \geq 1.3 F_u \frac{I_p}{R} \sqrt{\frac{\psi}{\psi_m}} = M_u \sqrt{\frac{\psi}{\psi_m}} \quad (= M_u \text{ as } \psi > \psi_m) \quad (1)$$

$F_u$  = ultimate transverse nail load;  $I_p$  = inertiamoment of nail pattern in sq.mm

$\psi$  = rotation of connection  $\psi_m$  = max. value of  $\psi$  before full plasticity

$R$  = greatest nail distance to the centre of rotation in mm

$C = 4/3 \text{ à } 3/2$  depending on the form of nail pattern. Using always  $C = 1.3$ , it is allowed to optimize  $I_p/R$  and disregard very excentric placed nails.

For a connection only loaded by ultimate tension  $P_u$ ,  $C = 1$ , so the moment deformations at  $M_{u/\omega}$  are much greater than the tensile deformations at

$\frac{H}{w}$  and the equivalent linear translational stiffness factor is much greater than the rotational one. (It is not possible to give one stiffness factor).

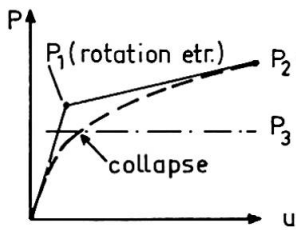

Fig. 2 scheme P-u

By the great plastic rotation of the joints, the stud contacted the horizontal member and the centre of rotation of the nail pattern shifted accordingly to this point of contact. So hardening occurred and a higher ultimate moment because of this eccentricity. (fig. 1-a).

Besides a joint rotation mechanism, a tensile force mechanism is possible as minimum mechanism (fig. 4).

The ultimate values of load P on the trusses can be calculated in 3 different manners. Based on the mechanism of rotation around the nailgroup centre a value P<sub>1</sub> is found representing the beginning of flow (fig. 2). A value P<sub>2</sub> can be calculated with the shifted rotation centre (fig. 1-a) at greater displacements and finally a value P<sub>3</sub> (fig. 2) is found if a tensile force mechanism is the limiting factor. In the tests was seen that P<sub>3</sub> (without hardening) actually occurred (fig. 2; 4).

Table 1. Beams with nailed joints

ultimate force P		calculated in kN		
		joint rotation		P <sub>3</sub> tensile force mechan.
beam nr. (fig. 1)	measurement P in kN	P <sub>1</sub> min. beginning	P <sub>2</sub> max. shifted centre	
3	11,0	11,3	12,4	11,0
4	11,6	11,2	12,0	13,2
5	11,8	9,9	12,4	11,7
6	14,9	10,9	14,4	21,0
2	13,7	13,5 equilibrium method		
		----- = occurred min. mechanism		

For the mechanism of joint rotation it can be deduced from plasticity the the diminishing of the maximum moment by an axial force H is:

$$M_{max} \approx M_u \left[ 1 - \left( \frac{H_{actual}}{H_{ultim.}} \right)^2 \right] \quad (2)$$

In table 1 the so calculated ultimate truss loads P are given

In beam 2 with continuous horizontal girders an incomplete mechanism appeared. (fig. 4).

In this case the ultimate moment in the continuous members was necessary for a mechanism, but it appeared that there was practically no plastic

deformation of these members. Because of knots and the many nailholes a brittle fracture with a volume-effect was possible in the horizontal tensile member. Regarding the trusses with glued gussets a mechanism was possible in the high loaded, glued, joints near to the studs (fig. 1 beam 5; 6). The rotational capacity was not sufficient for a redistribution to a mechanism with the, in the elastic stage low loaded, joints in the girders in between the studs. (see fig. 1, beam 3; 4.). They acted as if these girders were continuous. For continuous horizontal members, or members with low loaded joints in the elastic stage, a partial mechanism appeared in the glued joints near the outer studs before the wood reached its maximum moment, what was possible by the great elastic deformation of the members.

### 3. TIMBER FRAME DESIGN

The method of minimum mechanism of collapse can be used if only nailed joints are involved in the inelastic rotation. Because of the great rotational capacity every complete mechanism, where elastic deformations can be neglected, is possible. However, if the construction is not yet statical determinated for the minimum joint-mechanism, the ultimate moment in the wood is necessary in that



part to form a mechanism, and control of this partial mechanism, with brittle wood "hinges", is necessary. In this case, and also for glued connections, a design method has to be used, accounting for elastic and small plastic deformations. Such compatibility method, based on the virtual work equations, is recommended by the C.E.B. for concrete and can be extended for members with joints. Starting point is to choose sufficient hinges (restraint-releases) in the whole construction to make it statically determinate; so one hinge less than necessary for a mechanism. At the design stage, long-term effects on force distribution can be disregarded because of the increase of the possible deformations with creep. For nailed joints the short-term enforced displacements too, can be omitted because of the great deformation capacity. As a first approximation, the influence of the shearing force can be neglected, accounting this deformation by an adjustment of the modulus of elasticity. Also the influence of the normal force is small for frames; even for members with joints, as was seen in the tests. From the complete joint tensile mechanism, neglecting all joint rotations, that was possible. However, adjustments for column-instability and strength of the connections, (eq. 2) are necessary. For these reasons the virtual work equations of the  $n$  hinges become: ( $k = 1 \dots n$ ).

$$\int \frac{M_k \cdot M_o}{EI} ds + X_k \int \frac{M_k^2}{EI} ds + \sum_{i \neq k} X_i \int \frac{M_k \cdot M_i}{EI} ds + \sum_m \frac{M_k \cdot M_o}{C_m} + X_k \sum_m \frac{M_k^2}{C_m} + \sum_{i \neq k} X_i \sum_m \frac{M_k \cdot M_i}{C_m} = -\theta_k - \sum_m M_k \theta_m \quad (3)$$

$X_k$  = statical unknown at hinge  $k$ ;  $M_o$  = bending moment on the member due to the external load, and  $M_k$ , due to  $X_k = 1$ ;  $EI$  = bending stiffness of members and  $C_m$  of the joints, in, or intermediate between the release sections;

$\theta_k$  = the in elastic rotation at hinge  $k$  if the hinge is a joint and  $\theta_k = 0$  if the hinge is in the wood of the member;  $\sum M_k \theta_m$  = the inelastic contribution of the joints between the critical sections.

Choosing all joints as release sections, there are no intermediate joints and inelastic contributions, so the equations (3) become: ( $k = 1 \dots n$ )

$$\int \frac{M_k \cdot M_o}{EI} ds + \sum_i X_i \int \frac{M_k \cdot M_i}{EI} ds + \frac{X_k}{C_k} = -\theta_k \quad (4)$$

A bi-linear approximation of the force-displacements diagram of a joint is apparently accurate enough, so in eq. (4) it is possible to replace  $X$  by  $X_u$ , the ultimate moment in the hinges and if there are only connector hinges, all values of the left part of equation (4) are known and so  $\theta_k$  is immediately known. If there are wood hinges too, where  $\theta = 0$ , a set of simultaneous equations in  $X_i$  of the unknown wood-hinges remain, and in general not all the values of  $X_i$  of these hinges reach the ultimate value.  $X_i$  can be eliminated or resolved from the equations (starting at an end-hinge) and used in the connector-hinge-equations, where  $\theta \neq 0$ . So all terms are known then and all  $\theta$ 's can be determined and controlled to have the correct sign and value. If not, adjustments to the first trial  $X_u$ - or  $X_i$ -values must be made, putting  $\theta = 0$  where the sign was wrong. Fig. 3 gives an illustration of this method applied from symmetry to a quarter of the vierendeel-beam.

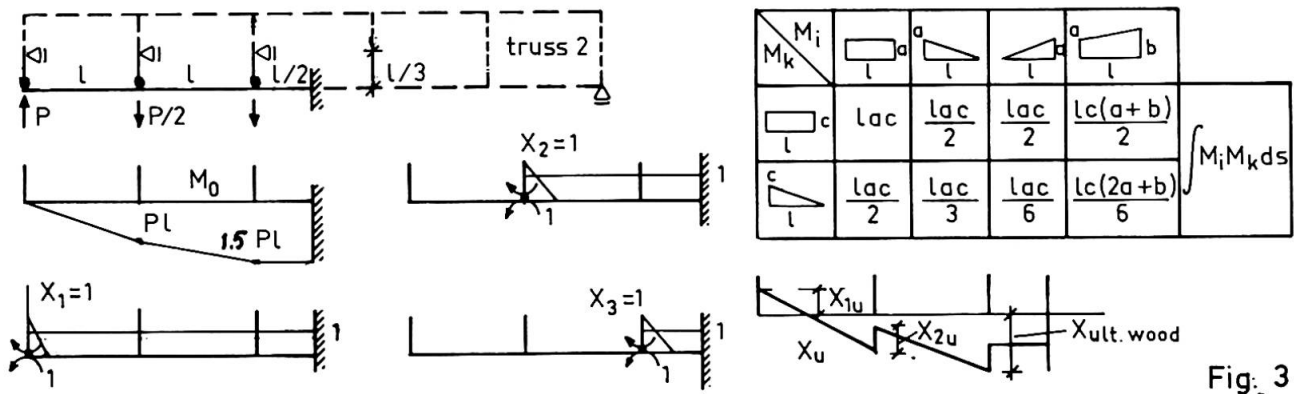

Fig. 3

In this case however, it is easy to look to the equilibrium of the horizontal girders assuming all mechanical joints flowing and controlling if the deformation of the continuous girders is enough to justify that assumption (table 1 beam 2).

#### 4. SOME CONCLUSIONS

- A pure mechanism (elasticity neglected) is possible for nailed joints if only these joints are involved in the mechanism and design can be based on this mechanism.
- When the ultimate moment in the wood is necessary to form a mechanism, an incomplete mechanism is possible, because of the small plasticity of the wood, and a compatibility method has to be used according to eq. (4).
- The same applies for glued joints if the force distribution of the mechanism is not too far away from the elastic distribution (elasticity can not be ignored). So, because of the minor redistribution, it seems better for timber with glued connections to use the simple approximation of linearity up to the ultimate stage, and the linear calculation of the rolling shear of the glued gussets, as a reasonable lower bound of the strength.
- The strength of the nail-pattern in the gussets for a moment is greater than  $1.3 \times$  the linear calculated value (eq. 1).
- The deflections of the vierendeel beam at working stage can be found by the method for built up beams, or by putting  $\theta = 0$  everywhere in eq. (4).
- From the recovery periods in the tests, it was seen that visco-plasticity was probably small. So a visco-elastic model is possible to determine the creep factor. This factor was about 1.8 for the nailed beam and about 1.6 for the glued one.

#### REFERENCE

Put, T.A.C.M. van der: Beproeving van vierendeelliggers. Rapport 4-79-8 onderzoek HS 11 Stevin laboratorium Delft, augustus 1979.

APPENDIX

PROPOSAL FOR TIMBER FRAME DESIGN

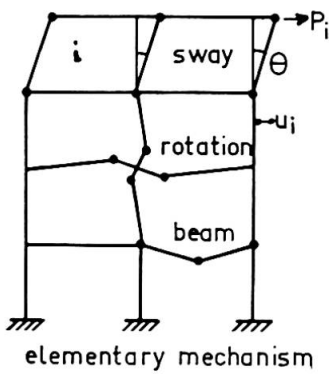

$$\sum M_{uj} \theta_j = \sum P_i u_i$$

$M_{uj}$  and  $\theta_j$

1. Mechanical joint mechanism is possible. The true (minimum) collapse mechanism has one degree of freedom, so is an elementary mechanism or combinations of these resulting in hinge eliminations. For timber the wood hinges must disappear, so the beam mechanism with the wood hinge in the middle is not possible. In general also rotational mechanisms contain one or more wood hinges for stiffness reasons. However, combinations of rotation- and sway-mechanisms (with wood-hinge elimination if relevant) result in elementary sway-mechanisms in the joints. So only joint-sway mechanisms have to be considered. Equilibrium of mechanism i requires that:  $\theta_j$  are plastic moments and relative rotations of joint j respectively, and  $W_i$  and  $\delta_i$  are loads and their corresponding displacements in the mechanism i. In  $M_{uj}$  is the influence of the normal force eq. 2. For buckling at yield, from the method of "split rigidities", the critical load  $P_{cr}$  is:

$$\frac{1}{P_{cr}} = \frac{1}{P_u} + \frac{1}{P_b} \dots (5) \quad P_u = \text{buckling load of the rigid member system} = \sum C/n$$

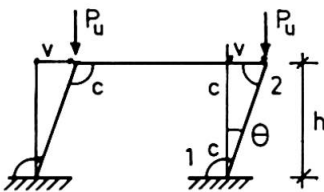

$$\sum P_u \cdot v = \sum M_j = \sum C_j \theta_j \rightarrow$$

$$P_u \cdot v = 2C \frac{v}{h} \rightarrow P_u = \frac{2C}{h}$$

$P_b$  = Euler buckling load of the elastic system with rigid joints.  $P_{cr}$  is immediately known by splitting rigidities in column, and joint with girders together.

2. Partial mechanism with "wood-hinges".

If there are not enough joints for a joint\_mechanism in a part of the construction comptability has to be controled according to eq. 4:

$$\int \frac{M_k M_o}{EI} ds + \sum_i M_{u,i} \int \frac{M_k M_i}{EI} ds = - \theta_{t,k} \text{ with } \frac{M_{u,k}}{C_k} < \theta_{t,k} (< \theta_{ult,k}) \text{ or total joint rotation must be greater than the elastic part at yield and } \theta_{t,k} = 0 \text{ for woodhinges. As above, instability (at yield) can be easily checked by the method of split rigidities.}$$

joint rotation must be greater than the elastic part at yield and  $\theta_{t,k} = 0$  for woodhinges. As above, instability (at yield) can be easily checked by the method of split rigidities.

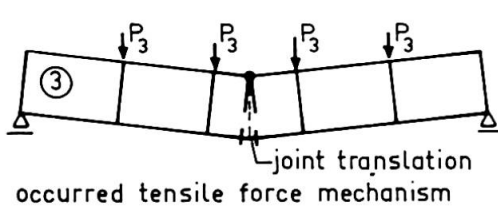

$P_2, P_3$ , see table 1

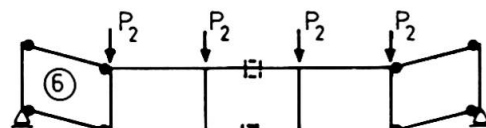
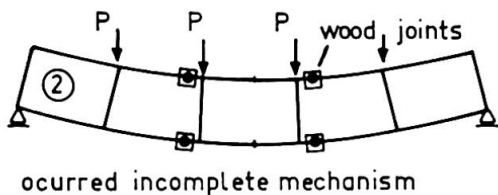
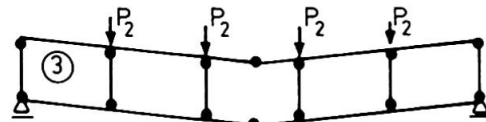

Fig. 4 Some mechanisms of failure.

**II****Truss Joint of High Efficiency**

Attaches optimales pour les noeuds de poutres en treillis

Systematisierte Fachwerkknotenverbindung mit hoher Holzausnutzung

**H. BLUMER**

Dipl. -Ing. ETH

Ing'büro Steiner, Jucker und Blumer AG

Herisau, Schweiz

**SUMMARY**

A steel-wood connection with high efficiency will be presented which is suitable for truss constructions. The newly developed system enable an essential simplification of the design, the drawing and the fabrication. The same equipment can be used for soft and hard wood.

**RESUME**

On présente un type d'attache mixte bois-acier convenant particulièrement bien aux constructions en treillis. Ce nouveau système conduit à une simplification des calculs statiques, des plans et de l'exécution. En atelier, les machines peuvent être utilisées aussi bien pour travailler les résineux que les bois durs.

**ZUSAMMENFASSUNG**

Dargestellt wird eine Holz-Stahl-Verbindung hoher Leistungsfähigkeit, die für Fachwerkkonstruktionen geeignet ist. Das neuentwickelte System ermöglicht wesentliche Vereinfachungen in der statischen Berechnung, bei der Planherstellung und bei der Fertigung. Für die Bearbeitung des Holzes werden Werkzeuge eingesetzt, die sowohl für Weich- wie auch für Hartholz geeignet sind.

## 1. SYSTEMBESCHRIEB

Bei der BSB-Verbindung werden hauptsächlich zwei Fachwerkstreben mit beliebigem Winkel an einen durchlaufenden Stab dem Fachwerkgurt angeschlossen. Ähnlich können zwei Stäbe gestossen werden.

Als Verbindungsmittel dienen typisierte Knotenbleche aus Stahl, sie werden in gefräste Schlitzte eingebracht. Die Kraftübertragung vom Holz auf die Knotenbleche erfolgt über Passbolzen aus Stahl. Diese werden in passend gebohrte Löcher eingetrieben. In Bild 1 sind die beiden Verbindungsmittel dargestellt.



Bild 1 Verbindungsmittel

Die Verbindungen sind streng typisiert. Es können 6 verschiedene Strebenbreiten Typ 1 mit einfacher und Typ 6 mit 6-facher Tragfähigkeit verbaut werden. Die Anzahl der Knotenbleche in Schlitzten übereinander kann von 2 bis 5 variiert werden, wiederum mit linearer Zunahme der Tragfähigkeit. Der Abstand beträgt jeweils 35 mm.

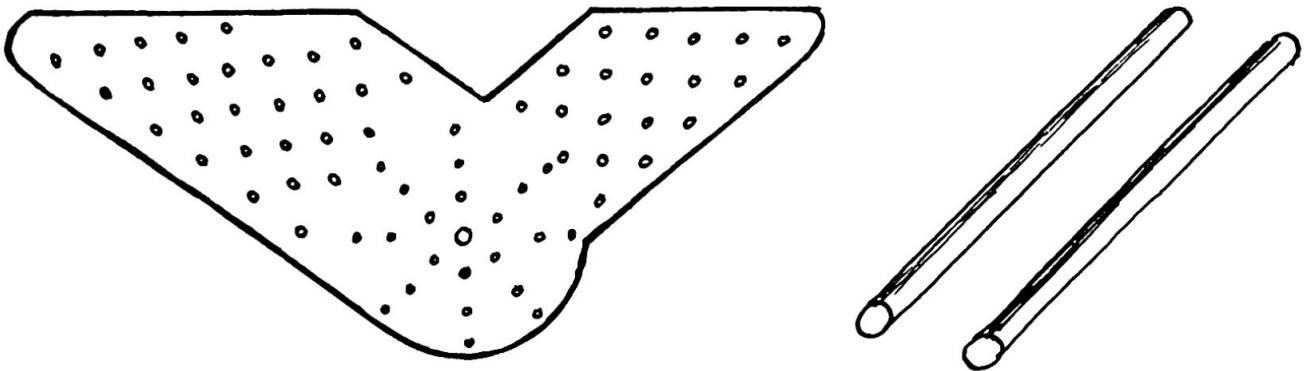

Bild 2 Typischer BSB-Knoten

Die Anordnung der Bolzen ist in Reihen bei den Streben und in konzentrischen Kreisen beim Gurt. Alle Zwischenabstände der Bolzen sind infolge des einheitlichen Durchmessers immer gleich. Ebenso sind die Holzquerschnitte vereinheitlicht und tabelliert. Da die Anschlüsse zentrisch sind, wird die Holzfaser nur längs beansprucht, dadurch sind hohe Anschlusswerte möglich. Für den Entwurf von Fachwerträgern liegen einheitliche Knotentypen vor.

## 2. EXPERIMENTELLE UNTERSUCHUNGEN

Im Vordergrund der Untersuchungen am Lehrstuhl für Baustatik und Stahlbau an der ETH Zürich stand die Abklärung folgender Fragen:

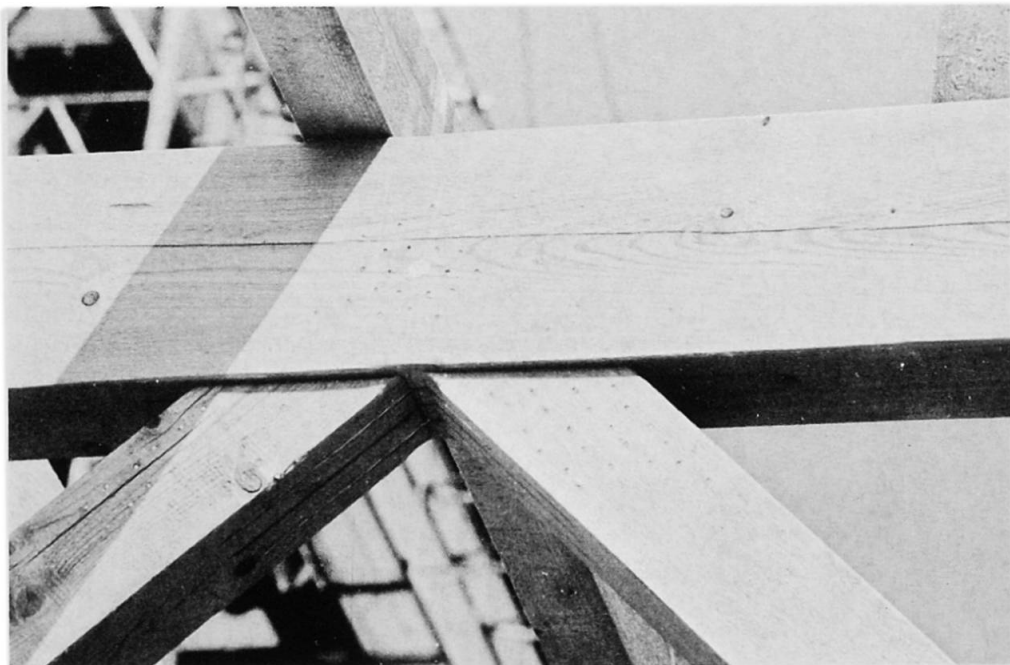
### 3.1 Zielsetzungen

- Tragfähigkeit von Passbolzen mit Durchmesser von 5 bis 10 mm im Kurzzeitversuch bei Beanspruchung parallel zur Faserrichtung.
- Einfluss auf die Tragfähigkeit der Passbolzen wenn Stahlgüte und Abstände variiert werden.
- Einfluss einer geringen Anschlussexzentrizität auf die Verbindungsfestigkeit.
- Verhalten von Stahlblech-Passbolzenverbindungen in Fachwerken.

### 3.2 Auswertungen

zu a) An Proben aus Fichten- und Buchenholz wurden im Zugversuch folgende Bruchfestigkeiten für Lochleibung am Nettoquerschnitt ermittelt:

$$\begin{aligned} \text{Fichte: } \sigma_{\text{Bruch}} &= 23 \div 27 \text{ N/mm}^2 \\ \text{Buche: } \sigma_{\text{Bruch}} &= 48 \div 53 \text{ N/mm}^2 \end{aligned}$$

Allgemein zeigte sich, wie auch aus der Literatur bekannt, dass dünnere Bolzen höhere Lochfestigkeiten erbrachten. Wichtig war die optimale Anordnung der Passbolzen.

- Abstände längs zur Faser ca.  $6 \times d_s$
- Abstände quer zur Faser ca.  $4 \times d_s$
- Schlankheit Holz (a)-Dübeldurchmesser ( $d_s$ )
  - Mittellagen ca.  $a/d_s = 6$
  - Aussenlagen ca.  $a/d_s = 2.5$

Bei der Querschnittsbemessung sind alle Schwächungen und ein Kerbfaktor von 0,8, entstanden durch die Bohrlöcher, in der Berechnung zu berücksichtigen.

zu b) Mit der Verwendung von hochfesten Stählen (Fließgrenzen von 1000 N/mm<sup>2</sup> und mehr) können grössere Bolzenschlankheiten bei gleichbleibender Tragfähigkeit erreicht werden.

zu c) In einer weiteren Versuchsreihe wurde abgeklärt inwiefern sich geringe Anschlussexzentrizitäten auswirken. Beim BSB-Träger werden durch die Verformung beim belasteten Fachwerk Biegemomente auf die Streben übertragen, was etwa gleichbedeutend mit einem exzentrischen Anschluss ist. Der Festigkeitsabfall ist bei dieser Verbindung weniger als 10 %.

zu d) Von grosser Bedeutung sind die richtige Dimensionierung der Knotenplatten ( $d_{\min} = 4 \text{ mm}$ ), die Einschnitttiefe (max. 160 mm) bei den Streben sowie der Abstand der Fräsenblätter (min. 35 mm). Werden diese Werte unterschritten bzw. überschritten, treten bei den Druckstäben frühzeitige Instabilitäten auf.



### 3. ANFORDERUNGEN AN DAS MATERIAL

Es liegt in der Zielsetzung des BSB-Verfahrens möglichst mehrere Holzarten mit unterschiedlichen Materialkennwerten zu verbauen. Zudem sollte aus Wirtschaftlichkeitsgründen zusätzlich zum Brettschichtholz auch Schnittholz z.B. Fichte und Tanne eingesetzt werden können. Diese unterschiedlichen Holzarten bedingen jeweils ein Anpassen der Verbindungsmittel bezüglich Stahlgüte und Stärke.

Für die in Europa einheimische Fichte werden zur Zeit Passbolzen mit 6,5 mm Durchmesser und einer Fließgrenze von 600 N/mm<sup>2</sup> verwendet. Die Knotenplatten weisen eine Stärke von 4 mm bei Stahl Fe 360 auf.

### 4. STATISCHE BEMESSUNG UND KONSTRUKTION

Die Bemessung und das Konstruieren von Verbindungen wird dann vereinfacht wenn es gelingt, möglichst viel zu systematisieren. Die hier beschriebene Verbindungsart vereinfacht die statische Bemessung indem der Spannungsnachweis im Knoten entfällt und lediglich noch an den anzuschliessenden Stäben mit einem einheitlichen Korrekturfaktor für den Schwächungsgrad in der Verbindung erfolgen muss. Somit kann eine Fachwerkstrebe wie folgt nachgewiesen werden.

$$D_{zul} = \sigma_{D||zul} \cdot F_{Brutto} \cdot w_D$$

$$Z_{zul} = \sigma_{Z||zul} \cdot F_{Brutto} \cdot w_Z$$

Dabei bedeuten: D, Z = Schnittkräfte Druck, Zug

$\sigma_{||zul}$  = zulässige Spannung

$F_{Brutto}$  = Bruttoquerschnitt des Stabes

$w_D, w_Z$  = Wirkungsgrad der Verbindung auf Druck, Zug

Analog werden Stabstösse und der Anschlusswert am Gurt berechnet. Die Wirkungsgrade der Verbindung  $w_D$  und  $w_Z$  wurden aus Versuchen mit 0,56 für Druck und Zug ermittelt. Diese Wirkungsgrade liegen auch bei anderen Holzarten in der gleichen Grössenordnung. Zum Vergleich erreicht man bei geleimten Keilzinkenstössen ein  $w$  von 0,8.

Analog zum Spannungsnachweis wird die Verformung über den Bruttoquerschnitt nachgewiesen.

$$\delta = \frac{\sigma_{vorh} \cdot l}{E_{||}} + \frac{2 \cdot \sigma_{vorh}}{C}$$

Dabei bedeuten: C = Verschiebungsmodul 10 N/mm<sup>3</sup>

$E_{||}$  = Elastizitätsmodul des Stabes

$\sigma_{vorh}$  = Vorhandene Querschnittsspannung

l = Stablänge

Die Typisierung der Holzquerschnitte und der Verbindung erleichtert das Konstruieren und beschränkt sich in fast allen Fällen auf das Festlegen der Systemachsen und die Angabe der Holzquerschnitte.



## 5. FERTIGUNG

Die Herstellung kann etwa wie folgt charakterisiert werden:

- a) Zerstörungsfreie Bearbeitung des Holzes mit Fräsen und Bohren (kein Pressen oder Spalten)
- b) Einheitliche Verbindungstypen, gleiche Bolzendurchmesser und Knotenblechstärken sowie gleichbleibende Abstände der Verbindungsmittel untereinander ermöglichen einen hohen Automatisierungsgrad (z.B. Einsatz von Mehrspindelbohrmaschinen und Mehrblattfräsen)
- c) Jedes Verbindungsmittel ist nach dem Einbau kontrollierbar.
- d) Der Einsatz der modernen Elektronik wird dazu beitragen, die Herstellung weiter zu automatisieren.
- e) Die Verbindung lässt sich aber auch manuell mit geringen Werkzeugkosten, z.B. notwendig für Montagestösse, bearbeiten.
- f) Jede Verbindung ist demontierbar.

Die Praxis hat gezeigt, dass Verbindungen mit kleinen anschlusskräftigen 0 - 30 kN relativ aufwendig und daher eher unwirtschaftlich herzustellen sind.

Günstig sind Kraftbereiche von 30 kN bis 100 kN und ausserordentlich wirtschaftlich sind alle Verbindungen mit über 100 kN.

## 6. ANWENDUNGSBEREICH

Die BSB-Verbindung eignet sich für Fachwerke mit mittleren bis hohen Anschlusskräften. Die Gestaltungsfreiheit beim Entwurf ist gross. Dabei muss im Entwurf nicht auf die Verbindung Rücksicht genommen werden, da sich diese immer konstruieren lassen; auch bei grössten Anschlusskräften. Nachfolgend sind die oberen Grenzwerte der Anschlusskräfte aufgeführt:

Holzart	Stabquerschnitt	Anschlusswert
Fichte Schnittholz FKII	12/28	160 kN (16 T)
Brettschichtholz	20/28	345 kN
Buche "	20/28	448 kN



Bild 3 Fachwerkbinder für Hallenbad  
(13 und 15 m)



Bild 4 Fachwerkbinder für Sporthalle  
(27 m)

## II

**Timber Bridges – Developments and Trends in North America**

Les ponts de bois – développements et tendances en Amérique du Nord

Der Holzbrückenbau in Nordamerika – Entwicklung und Tendenzen

**RICHARD M. GUTKOWSKI**  
Assoc. Prof. of Civil Engineering  
Colorado State University  
Ft. Collins, CO, USA

**THOMAS G. WILLIAMSON**  
Vice President  
LAMFAB Structural Wood Systems  
Indianapolis, IN, USA

**SUMMARY**

In North America, timber bridge engineering has undergone a resurgence of activity in the past decade. This paper describes the recent developments in materials, manufacturing, construction, analysis and design that have marked this time period. Activity concerning a systems approach, analysis for composite behavior, laboratory and field testing, and trends in research and design provisions are reviewed.

**RESUME**

En Amérique du Nord, la construction de ponts en bois connaît depuis 10 ans un renouveau d'activité. Ce rapport décrit les développements obtenus dans les matériaux de construction, leur fabrication, les méthodes de calcul, le dimensionnement et la construction durant cette période. On passe encore en revue les diverses activités déployées dans les domaines suivants: étude de systèmes, comportement d'éléments mixtes, essais in situ et en laboratoire, ainsi que les tendances dans la recherche et les règles de dimensionnement.

**ZUSAMMENFASSUNG**

In Nordamerika hat der Holzbrückenbau im letzten Jahrzehnt einen Wiederaufstieg erlebt. Die neuesten Entwicklungen in Materialien, Herstellung, Bau, Analyse und Entwurf in diesem Zeitabschnitt werden hierin beschrieben. Dieser Bericht umfasst eine Systemstudie, die Analyse des Verbundverhaltens, Labor- und Feldversuche, sowie eine Beschreibung der Tendenzen in Forschung und in den Bemessungsvorschriften.

## 1. BACKGROUND

The earliest application of timber in bridges was probably the incidental use of logs to cross small waterways. The close availability of material and short span requirements made this selection a natural expedient. As time passed, this simple structural form evolved into a many types of framed timber bridge structures. With each progression increased use has been made of wood's primary engineering advantages (high strength to weight ratio, ease of fabrication and erection, and a ready supply) while minimizing the disadvantages of its low modulus of elasticity and gradual degradation when exposed to the elements.

Covered timber bridges are excellent examples of the service longevity possible in timber bridges. Many over 100 years old are still in service. Protection of the superstructure from weathering is the key feature contributing to long life. In the United States interest in such bridges has been revived in recent years. A number of older bridges have been strengthened, restored for preservation, or transported to new sites. The 168 ft span Hunsecker Bridge (lattice construction) built in Pennsylvania in 1975 is one example of new covered bridges. The native round log stringer bridge is another older timber bridge type still in use. Such bridges are primarily employed for temporary logging bridges in the U.S. National Forests but more permanent installations exist in the remote regions of Alaska. These and other types of timber bridges continue as viable structures. However, evaluation of the structural soundness of older bridges is a prerequisite to the determination of load limitations. An excellent guide to the investigation of existing bridges is given by Hurlbut [1].

## 2. DECK SYSTEMS

The most common deck system used in older timber bridges was a nail-laminated assembly of nominal two-inch dimension lumber placed transverse to the supporting stringers. Connections consisted of through nailing of the laminations and toe-nailing to the stringers. In many instances a second layer was achieved by adding longitudinal planking atop the laminated deck to add strength and serve as a wearing surface. Performance of nail-laminated deck was quite satisfactory until the advent of glued-laminated timbers (glulam) led to increased stringer spacings. Despite adequate strength performance, the increased deck live load deflection contributed to loosening of the connections. Subsequent shrinking and swelling due to repeated wetting furthered the deterioration.

To improve deck stiffness, use has been made of reinforced concrete in recent years. In one approach concrete deck is employed in combination with timber deck to achieve a composite system. The timber deck laminations are grooved and dapped to provide a means of interlayer connections. As an alternative, a concrete deck can be compositely connected to specially prepared T-beams consisting of a glulam web and a poured in-place reinforced concrete top flange.

## 3. DEVELOPMENT OF PRESERVATIVELY TREATED GLULAM MEMBERS

Two significant factors have extended the use of timber in modern bridges: (1) development of glulam manufacturing methods and design criteria, and (2) technological advancements in preservative treatment of wood.

Glulam is an assembly of wood laminations (suitably selected and prepared) bonded together with adhesives. Glulam products are engineered and stress-rated according to established procedures. Basic criteria for fabricating glulam and establishing permissible design stresses based on grade of lumber



and natural strength reducing criteria (e.g. knots, slope of grain, grain deviation) and end joint type and placement were developed by the U.S. Forest Products Laboratory (USFPL). To establish these criteria, extensive analytical and experimental programs were conducted, beginning about 1940, and details are available in a complete report [2]. Subsequent test programs conducted by the USFPL and Oregon State University led to the initial development of industry specifications for fabrication glulam members from visually graded and machine graded (E-rated) materials. An extensive bibliography on timber highway bridge design is available in the literature [3] and includes a listing of several standard specifications for both glulam and wood members in general.

Wood is a biological material and susceptibility to decay is its most serious drawback. However, when properly protected from the elements it is highly durable. The service life of timber bridges can be extended to 50 years or more by the introduction of modern pressure impregnated preservative treatments. Chemicals used as preservatives in timber bridge materials should be selected in accordance with the current standards for glulam members. The basic standards are those prepared by the American Wood preservatives Association and the American Wood Preservers Institute. The AWP and AWPI standards are listed in the bibliography cited earlier [2]. Some research has also been conducted on arresting or delaying decay of older timbers [4]. It is also possible to employ fire retardants to reduce the rate of flame spread. However, most treatments do not reduce fire endurance and result in some reduction (10-25%) in member strength.

#### 4. MODERN TIMBER BRIDGES

Significant advances in the engineering and construction of timber bridges have been made in the past two decades [5]. Glulam timber members have virtually eliminated the use of solid sawn members as the main structural elements and nail-laminated decking has been replaced by glulam deck panels. Simple connections and prefabrication of components contribute to rapid erection. Economical, straight girder bridges are now practical for spans up to 100 feet. For aesthetics and material savings, flat arches are often used in place of straight stringers. For greater spans or low water clearance sites, truss or deck arch configurations are employed.

Parallel chord bridges are economical for a span range of 100 to 250 feet. When clearance is an issue, bowstring trusses are employed in two configurations: the pony and the through span. The former is recommended for 50 to 100 foot spans and the latter for longer spans. In each the chord members are glulam timbers while the smaller web members are usually solid sawn. Prefabrication at the plant, field assembly at the site, and lifting into position for connection is the normal construction sequence. All glulam components are preservatively treated using pressure impregnated creosote.

Deck arch bridges are efficiently utilized for spans up to 300 feet. Generally, three-hinged arches are used as the main support elements and loads are transferred from the deck to the arch by means of timber bents. All wood components are glued-laminated. An early example is the 104 foot span Loon Lake Bridge in Oregon built in 1948. The bridge has a 20 foot roadway width, but employs a nail-laminated deck. The upper level of the Keystone Wye Interchange is a more recent example of a deck arch bridge. This compositely designed bridge spans 290 feet and employs glulam-concrete T-beams in combination with a concrete deck.

Harvesting of remote forest land creates a high demand for bridges intended for



low volume traffic consisting of heavily-loaded logging trucks and related heavy equipment. Scarisbrick [6] describes some notable glulam bridge configurations, used in British Columbia. Simple-span bridges in which deep I-beams or double I-beam glulam girders are employed are most common. Typically, girders dimensions range up to an 86 in. depth, a 12 in. web width, and a 20 in. flange width. A number of trussed girder configurations have been employed for spans between 127 ft and 270 ft. Cable-suspended bridges in which glulam is used in the superstructure (including towers) are also described.

In 1973 the Ontario Ministry of Transportation and Communications undertook a long term program [7] aimed at assessment of the load carrying capacity of existing wood bridges and development of methods for improving capacity as an alternative to replacement. As a result of extensive field studies and tests performed as one phase of this program, an effective means of post-tensioning laminated timber deck has been developed [8]. Another aim of the development program is to incorporate the developed methods into new bridge design and construction practices.

## 5. STRAIGHT STRINGER BRIDGES

### 5.1 Description

Standardization and systems approach to construction have a long history of usage in timber structures. Bridge engineers identified a need to incorporate a systems concept in the design and construction of timber bridges. Also, declining supplies of large solid-sawn timbers were a deterrent to the continued viability of timber bridges. In response, the timber industry developed construction concepts and design criteria for a glulam girder-glulam panel deck system to be implemented in highway bridges.

The conventional glulam stringer bridge system employs preservatively treated glulam stringers and the glulam deck panels and includes an asphalt wearing surface. Typical dimensions and design aids [9] as well as case studies [5] are available in trade association publications. Deck panels are made of nominal 2 in. dimension lumber vertically laminated to form a flat slab. Individual panels are generally 4 feet wide and the laminations traverse the entire roadway width. Steel dowels provide shear and moment transfer between adjacent deck panels. Stringers and deck panels are interconnected by lag bolts.

### 5.2 Research And Development

In addition to being the most inefficient part of the conventional timber bridge, the nail laminated deck did not provide a sufficient "roof" over the bridge structure as is desirable to extend overall bridge service. In 1978, research was undertaken by USFPL to evaluate the concept of utilizing a glued laminated deck panel. Basic structural properties of glued laminated deck panels were compared with those of the commonly used nail-laminated deck. Load transfer under static loads was studied in laboratory tests. Experimental bridges were also constructed using the panel deck concepts to study field construction and performance. Experimental investigations of the panel deck systems were supplemented with a theoretical analysis by orthotropic plate theory to develop the necessary design criteria. Details of the work are given in two reports [10, 11] and are the basis of the current AASHTO specifications for glulam bridge deck.

The connection devices in the glulam stringer were devised for ease of construction. Proper lead hole size for the dowels is essential both for adequate load

transfer and ease of alignment of adjacent deck panels during jacking. However, the present recommendation (1/32" oversize) hinders desired erection. The influence of this parameter was investigated in a recent study [12]. Mechanical interconnection also produces a degree of composite action. However, the inherent interlayer slip and gaps at the deck panel interfaces render the interaction incomplete. Recent research [13, 14] describes a proper analytical model for analyzing the partial composite behavior. Analytically generated "composite action curves" (e.g. Fig. 1) are employed to study the influence of the significant parameters; affecting composite action, namely, interlayer slip, gap condition and deck material properties. These studies reflect the reserve strength that is generally possible due to composite action. Generally, the ratio of composite to non-composite displacement,  $\Delta/\Delta_N$  is used as a measure of performance. Use of such curves and tests of large scale models of bridge cross-sections point to the potential for a high degree ( $\approx 50\%$ ) of composite action in prototype glulam bridges.

### 5.3 Recent Developments

Other stringer bridge configurations have been developed which incorporate special features designed to enhance service life. One manufacturer (Weyerhaeuser Co., Tacoma, Washington) has marketed a panelized glulam bridge system which features a patented aluminum clip angle connection for which no bolt holes are needed in the stringers. This simplifies erection by eliminating dowels, avoids direct entry of moisture into the stringers, and facilitates easy replacement of damaged components. In another system [15] Press-Lam is used (in place of glulam) for all components of the superstructure. Press-Lam (Fig. 2) is a Parallel Laminated Veneer product manufactured by adhesive bonding of rotary-peeled veneer. When compared to solid-sawn lumber, the Press-Lam exhibits less variability in mechanical properties and improved penetration and retention of chemical preservatives. A prototype highway bridge has been constructed and is being field tested. In service performance is to be monitored over a five year period.

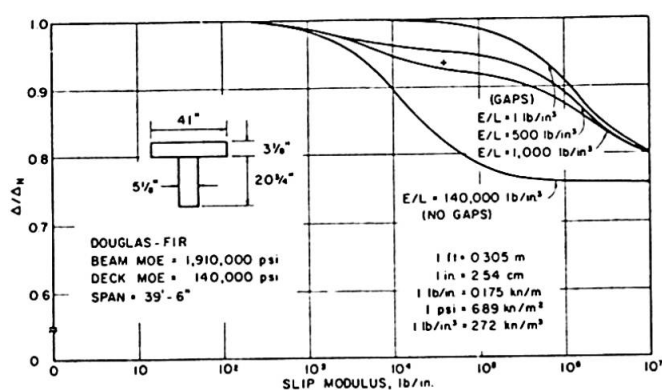

Fig. 1 Example Composite Action Curves

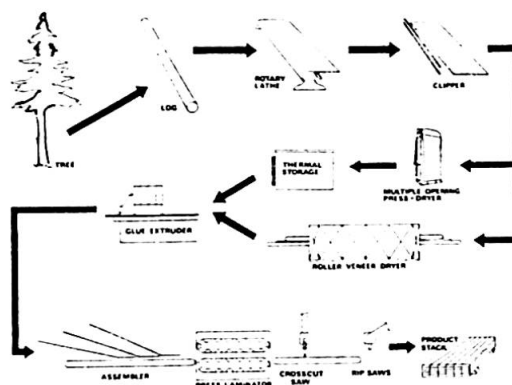

Fig. 2 Press-Lam Processing

## 6. CURRENT TRENDS IN RESEARCH AND DESIGN

Future design codes are certain to reflect the great activity by the engineering community on several issues. Rationalization of limit states design for uniformity in the various structural codes, incorporation of reliability based strength, and development of a systems approach to the analysis of structures, are among the most significant. A complete report on research needs has recently been compiled [16].

Material variability has been long recognized in the development of allowable stresses for wood. The use of a 5% exclusion limit in the statistical analysis of small specimen properties is well known. Currently, the measurement of in-grade strength of full-size members as a basis for future allowable design stresses is of considerable concern. Further, many researchers point to brittle fracture as the initiator of structural failure in wood and are applying fracture mechanics theories in an attempt to better understand the ultimate strength limit state.

Probabilistic methods offer a means of incorporating reliability (safety) into the investigation of a structure's limit states. Theories have been derived and applied to steel [17] but some difficulties exist when applied to wood [18]. Some researchers believe the use of a lognormal distribution in the codification is inappropriate for wood, preferring a Weibull probability distribution in its place. Also, the load duration characteristics of wood (time dependency) is not included in present formulations. A method for developing allowable stresses for temporary glulam structures which accounts for load duration is available [19]. However, the results are presented in a working stress design format.

There is some feeling amongst bridge engineers that the distribution of wheel loads by timber deck produces stringer loads measurably below those currently specified in AASHTO provisions (which predate modern analytical methods). This belief is supported by recently conducted service and ultimate load field tests [20, 21]. The findings suggest some modification of current code provisions is justified.

## 7. CLOSING REMARKS

In light of modern materials, improved construction methods and rigorous engineering methodology, one can produce durable, safe timber bridges configured for contemporary secondary highway loads. Wood is an abundant, lightweight, naturally aesthetic, renewable construction material. Its application in bridges on secondary road systems is certain to increase rapidly in face of rising construction costs and world-wide energy constraints.

## REFERENCES

1. Hurlbut, B. F., "Basic Evaluation of the Structural Adequacy of Existing Timber Bridges", Transportation Research Record 647, Transportation Research Board, National Academy of Sciences, 1977.
2. Freas, A. D. and Selbo, M. L., "Fabrication and Design of Glued Laminated Wood Structural Members, USDA Technical Bulletin 1069, Forest Products Laboratory, U.S.D.A., Madison, Wisconsin, 1954.
3. Committee on Wood of the Structural Division "Bibliography on Timber Highway Bridge Design", J. Structural Division, ASCE, Vol. 101, No. ST1, Jan. 1975.
4. R. D. Graham, M. E. Corden, and T. C. Sheffer, "Controlling Biological Deterioration of Wood with Volatile Chemicals", Forest Research Laboratory, Oregon State University, 1975.
5. Modern Timber Highway Bridges. - A State of the Art Report, American Institute of Timber Construction, Englewood, Colorado 1973.

---

NB. The references 6. to 21. are given on page 176.



## II

**A Structural Wood System for Highway Bridges**

Un système porteur en bois pour ponts-routes

Holzbausysteme für Strassenbrücken

**PAUL F. CSAGOLY**

Engineering Research & Development Branch  
Ministry of Transportation and Communications  
Downsview, Ont., Canada

**RAYMOND J. TAYLOR**

Engineering Research & Development Branch  
Ministry of Transportation and Communications  
Downsview, Ont., Canada

**SUMMARY**

The Ontario Ministry of Transportation and Communications (MTC) is developing a new family of timber bridges based on the transverse post-tensioning of longitudinally laminated decks. The paper highlights only selected findings. The development program is aimed at rehabilitating wood as a viable and competitive structural material for bridges. The system permits low grade materials, consumes less than 10 percent of the energy required by steel bridges and can be built, by unskilled labour, any time of the year.

**RESUME**

Le Ministère des Transports et Communications de l'Ontario développe actuellement un nouveau type de ponts en bois, basé sur la précontrainte transversale de madriers. Ce rapport met en valeur les résultats les plus intéressants. Le but de ce programme est de réhabiliter le bois, matériau compétitif et durable, dans la construction de ponts. Le système développé permet l'utilisation de bois de qualité inférieure, il est insensible aux conditions climatiques, nécessite moins de 10% de l'énergie requise par la solution métallique et peut être monté par un personnel non qualifié.

**ZUSAMMENFASSUNG**

Das Ontario Ministry of Transportation and Communications hat eine neue Art von Holzbrücken entwickelt, die auf dem Prinzip der Quervorspannung von längs angeordneten Bohlen beruht. Das Referat beschreibt nur einige ausgewählte Ergebnisse. Das Programm hat zum Ziel, für Holz als Brückenbaustoff zu werben und die Entwicklungs- und Wettbewerbsfähigkeit des Holzes aufzuzeigen. Das System erlaubt die Verwendung von Holz geringer Qualität, ist witterungsunabhängig, benötigt weniger als 10% der Energie einer entsprechenden Stahllösung und kann durch Hilfskräfte ausgeführt werden.



## Summary

The Ontario Ministry of Transportation and Communications (MTC) is developing a new family of timber bridges based on the transverse post-tensioning of longitudinally laminated decks. The paper highlights only selected findings.

The development program is aimed at rehabilitating wood as a viable and competitive structural material for bridges. The system permits low grade materials, consumes less than 10 percent of the energy required by steel bridges and can be built, by unskilled labour, any time of the year.

## Traditional Design

This paper deals essentially with the rehabilitation and improvement of bridges constructed using longitudinally laminated, nailed decks supported by timber pile bents. Hundreds of these bridges exist in the province of Ontario, and there are probably several thousand of them throughout Canada.

In present designs the maximum span length is about 6.0 m, however, a multi-span, continuous deck may exceed 100 m in length. Traditionally, a deck is constructed in multiples of three, such that one laminate is butt-jointed over the pier and the other two at alternating third points of the span. There is no physical continuity of the laminates provided at the butt-joints other than two nails by which the ends are connected to the adjacent laminates.

## Observed Modes of Failure

The maximum permissible single axle weight in Ontario is 10 000 kg (98.06 kN), but on logging and mining roads where many of these bridges are located, weights of up to 20 000 kg (196.12 kN) have been frequently observed. This observation is reflected in the new Ontario Highway Bridge Design Code which specifies a 200 kN single axle and a 280 kN tandem for the design of bridge decks.

Under such loads these bridge decks often fail. The failure is precipitated by the bending of nails and the crushing of the adjacent wood. In addition, incompressible materials may accumulate between the laminates, being driven down by the tires of heavy commercial vehicles. This allows water to enter between the laminates and to penetrate to their untreated heartwood through the enlarged nail holes. The combined effect of wood decay and decreasing transverse load distribution among the laminates often leads to local deck failures after only a relatively short service life.

Another significant weakness of these decks is the absence of longitudinal continuity of the laminates. A recent test carried out on a two-span, nailed strip consisting of 24 lines of laminates indicated that the lack of continuity caused a total disintegration of the structural system at less than 60 percent of the predicted ultimate load, although the laminations proper showed no signs of flexural failure. Another test, where repeated service level loads were applied, resulted in a similar failure after only 65,000 cycles as opposed to a minimum of 500,000 cycles required by the Ontario Highway Bridge Design Code.

## Retrofitting Existing Structures

Normally bridges that displayed local failures in the past were immediately replaced. However, due to the deteriorating economy and the high cost of replacements, MTC directed its continuous bridge testing program towards wood



structures in 1973. This program is aimed at determining the behaviour and load carrying capacity of existing bridges. Since that time numerous bridges have been tested including trusses, sawn timber stringers, glue laminated girders, laminated decks with or without concrete overlay and wood piling.

Specifically, the load carrying capacity and the service life of the longitudinally laminated decks were identified as being a direct function of the "tightness" of the structural system. ("Tightness" is defined as the ability of the structure to withstand relative interface movement and the access of foreign materials between adjoining components). The solution to retrofitting these structures was therefore sought in creating an artificial "tightness" and it was found in transverse post-tensioning the deck.

A small three-span bridge with a total length of 16.78 m (55 ft.) and a longitudinally laminated timber deck, came up for replacement in 1976. Built in 1951, its deck now showed signs of irreversible deterioration along the lines described above. The bridge is located on a logging road where heavily loaded trucks travel at relatively high speeds.

The prestressing system employed consists of pairs of 16 mm (5/8 in.) diameter Dywidag bars at 0.915 m (3.0 ft.) centres anchored in steel plates along the sides of the bridge deck. The bars were protected by enclosing them in grease-filled PVC pipes. The top bars were layed in transverse troughs cut into the asphalt wearing surface, while the bottom bars were attached to the wood deck by brackets and screws.

The prestressing of the pairs of bars was carried out in a sequential manner by using two jacks at a time. This operation had to be repeated several times as the width of the deck shortened by as much as 460 mm (18 in.) before the specified average prestressing stress of 0.69 mPa (100 psi) had been attained. About 82 percent of this shortening was related to straightening the laminates and closing the spaces between them. After prestressing, efforts to insert razor blades between the laminates failed, and during a rainfall it was observed that the deck became practically water tight.

The bridge was load-tested before and after the application of prestressing, using one of the two MTC testing vehicles. The maximum gross weight of these vehicles is 890 kN (200 kips) each and any bridge that is not substandard is expected to support either or both (as the case maybe) of these vehicles without any sign of distress. The deck indicated a local failure at the 795 kN load level prior to prestressing. After prestressing, the bridge sustained the full specified load without any difficulty.

The improvement in behaviour was substantial: measured deflections, hence stresses in the laminates, across the deck had been reduced by a factor of 2.0. The bridge has been monitored on a continuous basis since then, and no further deterioration of the deck has been observed. The prestressing force was found to somewhat fluctuate with changes in temperature and humidity of the ambient and to have stabilized after four years at approximately 55 percent of the original value. This is more than adequate.

During the summer of 1979, two other structures were retrofitted by transverse post-tensioning. One is on a country road in Southern Ontario; the other - a major bridge - is at Prince Rupert, British Columbia. Both operations were successful.



## Characteristics of the Prestressed Wood Deck

The MTC wood development program includes a number of individual projects: a few have been completed, some are underway and others have yet to be started. Consequently, in order to describe the characteristics of the prestressed wood deck, certain stipulations are to be made. But from all the evidence so far available, it is certain that it responds to loads as an orthotropic plate that derives its strength at ultimate limit states from a combination of the following:

- by improving the lateral distribution of wheel loads,
- by forcing the system into load sharing action,
- by preventing the development of torsional shear stresses, and
- by longitudinal "bridging" of defects and discontinuities.

The improvement of lateral distribution of wheel loads has been demonstrated by the bridge (Hebert Creek) that had been retrofitted in 1976. The other three items will now be discussed.

### Load Sharing at Ultimate Limit States

In the Ontario Highway Bridge Design Code "load sharing" is defined as a construction composed of three or more essentially parallel members so arranged or connected that they mutually support the load; in case of failure of one member, the system retains its capacity to support the load.

In order to create a data base, MTC contracted the Western Forest Products Laboratory (WFPL) of Vancouver, to undertake the testing of a large number of wood specimens both in individual and load sharing modes. Three species were included, namely B.C. hem fir, Ontario red pine and Ontario white pine. All samples were 51 mm x 254 mm rough-sawn boards, 4.88 m (16 ft.) long. They were purchased green and kiln-dried to an approximate moisture content of 19 percent.

After retaining only that material graded as #2 and better, each sample size was reduced to about 420 specimens. Sixty of each species were tested individually for elasticity and modulus of rupture. The rest were tested for load sharing by combining together either 6, 12 or 18 laminates per specimen by transverse post-tensioning. Each of the three groups contained 10 beam units for each species, totalling 90 post-tensioned wood specimens.

It had been observed that the average values, regardless of the number of specimens in the beam, hardly fluctuate, but there is a dramatic increase in ultimate strength for the load sharing systems. The increase from individual specimens to an 18 - laminates beam is 82.5, 74.9 and 50.8 percent for white pine, red pine and hem fir, respectively. This increase is not associated with transverse distribution as the load was always applied uniformly across the width of the beam.

As a result of the individual specimen tests, the stiffness versus strength relationships were plotted separately for the three different species, and straight line, best-fit analyses were carried out. It was observed during the WFPL tests in Vancouver, (and in similar tests carried out at the University of Toronto and at MTC's own laboratory in Downsview) that the ultimate load carrying capacity is attained usually after about 25 percent of the laminates are broken. The availability of the stiffness v. strength functions permitted the construction of a statistical model, by which the average failure sequence of transversely post-tensioned laminates can be described.

Calculations were carried out for beams with 24 laminates, a number that provides for the width of a bridge deck within which deformations are uniformly distributed. It is interesting to note that for all three species, maximum strength was obtained after six laminates failed, a phenomenon that was confirmed by several laboratory tests carried out on full-size laminates. The calculated strength increase due to load sharing were 58.0, 59.6 and 43.7 percent for white pine, red pine and hem fir, respectively. These leave, in comparison with the WFPL test results, 24.5, 15.3 and 7.1 percent actual increases yet to be explained.

#### Shear Stresses and Internal Bridging

In preparation of the Ontario Bridge Code, MTC contracted the University of British Columbia to carry out in-grade testing of large sawn-timber beams. The part of the project that is of interest here, included 452 individual specimens of 152 mm width, of which 48 were broken. Sections with three different heights were included, namely 203 mm, 305 mm and 406 mm. All wood was rough-sawn B.C. fir, graded #1 and better, with moisture content between 21 and 44 percent.

It appears that ultimate flexural strength is decreasing with the width-to-height ratio of the cross section. The total reduction from 203 mm to 406 mm is an astonishing 40.4 percent. At the time of this writing, there is no readily available explanation for this phenomenon and it is not certain that all species and cross sectional sizes would exhibit the same trend. It can be speculated, however, that the answer to this question should perhaps be sought in the macro-structure of the wood proper.

When a close-to-square section is formed, it likely includes the whole log, cut to eliminate the circumferential material. This leaves the macro-structure symmetrical, both ways, to the centre of gravity of the section. When two or more sections are cut from a log, say 51 mm x 305 mm material used in laminated decks, the chances are that none or only one section will end up with a symmetrical macro-structure. This lack of symmetry causes the shear centre of the section to move away from the centre of gravity, resulting in torsional moments under vertical loading.

It has been observed that when a single plank (laminate) is being tested for flexure in the cantilever mode, the end of the plank tends to rotate around its longitudinal axis. On the other hand, the transversely post-tensioned decks internally eliminate torsional moments due to the random orientation of the individual macro-structures and do not permit the development of torsional stresses due to close to absolute confinement.

It appears evident that the strength of individual specimens is determined by internal discontinuities (knots) and by interrupted and misaligned grains. The reduction in comparison with parallel grained clear specimens is, on the average, 40 to 60 percent, depending on whether the failure is compression or in tension. It is also statistically obvious that discontinuities and faults are randomly distributed in a laminated deck, i.e. they do not constitute a line of weakness in the orthotropic continuum created by post-tensioning. The transverse post-tensioning mobilizes longitudinal friction of considerable magnitude among the laminates by which longitudinal flexural stresses can by-pass the discontinuities.

This "bridging", along with the elimination of torsional stresses, is believed to be responsible for the part of apparent strength increase, not explainable by the statistical process described. These aspects will be investigated by MTC in the near future.

### Longitudinal Continuity of Laminates

The third point butt joints, mentioned earlier, have proved to be lines of considerable weakness, since laminates tend to move independently under loads. The test at the University of Toronto indicated a disastrous effect: the nails split the ends of the laminates resulting in a piano-key type of failure.

In order to eliminate this weakness, a variety of methods of correction were considered. The one that was found to be most feasible involves the "nail-plate" or "gang-nail", a commercially available fastener being used in prefabricated wood trusses for residential construction. The gang-nail is manufactured from galvanized sheet metal by punching out the teeth with a machine die. These plates are then pressed into the wood applying hydraulic jacks and are used to connect two components together. The sheet comes in various thicknesses and is made of mild steel with an ultimate tensile strength of 320 mPa.

From pilot tests it appears that a 14 gauge (1.90 mm) plate would match the flexural strength of a 51 mm (2 in.) thick red pine laminate at their mutual 5th percentile level. However, since the strength coefficient of variation of steel is only 8 percent while that for red pine is 36 percent, it is assured that, in a load sharing system, the plates would rupture first. Thus, the use of plates on these decks introduces ductility, a highly desirable structural feature, that wood when failing in tension does not possess.

Cyclic tests carried out by others in the past showed that the fatigue life of these plates is disappointingly low. The mode of failure is either the fracture of the nails at the neck or their gradual slipping out of the wood. MTC's own tests indicate that the presence of compressive stresses between the laminates due to prestressing tends to inhibit both failure modes and assures sufficiently high fatigue life at service load levels. The same tests also seem to prove that in the post-tensioned deck moment transfer by the plates is of secondary significance: the primary requirement is shear transfer by which "piano-key" type of failures are prevented.

### The Stressed Wood System

Considering improved transverse load distribution and strength enhancement by load sharing, the improvement due to transverse post-tensioning is 272, 256 and 207 percent for white pine, red pine and hem fir, respectively. In accordance with the provisions of the Ontario Bridge Code, these would permit maximum simply supported spans of 6.0 m, 8.7 m and 11.8 m for the species in the same order. Unfortunately, deflections associated with these spans for red pine and hem fir are unacceptable and it appears, therefore, that on account of the dramatic enhancement in load-carrying capacity due to transverse post-tensioning, only those tree species that have strength characteristics close to white pine can be used economically. In order to make appropriate use of the available strengths of the tensioned decks, they must be combined with other structural systems.

#### a. Decks for Existing Truss Bridges

Many existing truss bridges, steel or wood, have problems of deterioration of their decks, either concrete or wood. The transversely post-tensioned, longitudinally laminated wood deck is an eminently suitable replacement for these decks due to its light weight, improved load distribution among cross beams and contribution to the strength of the bottom tension chords of the trusses.

#### b. Composite with Concrete Overlay

Under development is a wood/concrete composite at present. The shear connector is a continuous concrete key, 125 mm wide and 38 mm deep, cut into the top of the laminated deck by a gang-saw. The key is reinforced at its tension side by a

250 mm long ARDOX nail, driven into every third laminate, at an appropriate angle. The second role of the nail is one of holding the concrete overlay down. The key provides for fully composite action such that the 305 mm wood deck with a 102 mm concrete overlay is estimated to be able to span close 15 m (50 ft.). The concrete overlay can be used as a wearing surface without further protection.

c. Longitudinal Web Splice

The structural height of the laminated deck can be increased by splicing two planks together along their edges by using strips of the gang-nail. Depending on span and load requirements, the spliced element can be combined with a number of ordinary deck laminates in a repeated fashion. They are all held together by transverse post-tensioning applied at the centre of the deck. A version of this idea is where the spliced element is combined with ordinary deck elements at both top and bottom, each having its own prestressing, thus creating a multi-cell structure.

d. Integrated Deck Trusses

If larger span requirements are to be satisfied, the structural height provided by the spliced elements may not be adequate. They can be replaced by trusses whose elements are held together by gang-nails of appropriate size and configuration. In some cases, struts or stayed legs can replace the trusses. Again, the post-tensioning system, applied at both top and bottom (with spacer blocks) chords, is the integrating agent.

e. Stiffening by Tie Bars and Kingposts

Many of the existing wood truss bridges have their cross beams stiffened and strengthened by the addition of tie bars. The system has an excellent record in Canada. Longitudinal bars can be used to stiffen the transversely post-tensioned laminated decks. A system with two king posts would give a maximum span of 22.7 m (74.4 ft.) in white pine.

f. Steel/Wood Composites

The longitudinally laminated wood deck can be made composite with longitudinal steel girders by the way of continuous steel angle shear connectors bolted to the top flange. The angles protrude into slots cut in the bottom of the laminates and contribute to the lateral distribution of wheel loads. Excellent for both new construction and retrofitting.

### Cost, Energy and other Considerations

From the three bridges that have been rehabilitated by transverse post-tensioning it appears that the cost (in Canadian Dollars) of a new bridge would not exceed \$325/m<sup>2</sup> (\$30/sq.foot) of deck area, while the rehabilitation including new bulkheads and the stripping of existing wearing surface and subsequent resurfacing, is about \$95/m<sup>2</sup> (\$9/sq.foot). The construction of these bridges is entirely mechanical and therefore could be done any time of the year. Since the bridges are built up from relatively small elements, in most cases the presence of a crane may not be required.

Observation of these shows them to be extremely tight and waterproof. In addition, the prestressing forces do not permit the development of cracks when heated, and therefore resist the escape of flammable gases. The epoxy coating is guaranteed to protect the Dywidag bars for approximately 35 years. The system permits the removal of the bars, one at a time, without loss of strength and interruption of vehicular traffic, for examination and replacement if so required.

Wood is a renewable structural material and it has been shown consistently throughout this paper that the enhancement by transverse post-tensioning makes feasible the application of the lowest grade species for bridge construction. The system requires an extremely low amount of energy, an aspect that will have major consequences in the years to come.

Leere Seite  
Blank page  
Page vide



**II****The Stress Distributions of a Partial Uniform Load Applied to Timber**

Répartition des tensions dans un élément en bois soumis à une charge répartie locale

Die Spannungsverteilung bei Lasteinleitungen in Holzbauteilen

**J. CHULSOO YU**  
Professor  
Korea University  
Seoul, South Korea

**SUK YOON CHANG**  
Assistant Professor  
City University of Seoul  
Seoul, South Korea

**SUMMARY**

Using Fourier integral, an exact solution for the stresses of isotropic and orthotropic half-infinite plane loaded by a partial uniform load is presented. Numerical results of the stress distributions are given for three layered plywood and laminated delta wood. The results can be applied to the analysis and design of timber connections.

**RESUME**

On applique la méthode des intégrales de Fourier au calcul de la répartition des tensions dans un demi-plan isotrope et orthotrope soumis à une charge répartie locale. On présente une solution théorique exacte, puis les résultats numériques obtenus dans le cas de bois croisé à 3 couches et de lamellé-collé. Ces résultats peuvent être utilisés pour le calcul et le dimensionnement des attaches d'éléments en bois.

**ZUSAMMENFASSUNG**

Mittels Fourier-Integrale werden für isotrope und orthotrope Halbebenen die Spannungsverteilungen für eine gleichmässige Teillast abgeleitet. Für dreischichtiges Sperrholz und für geschichtetes Delta-Holz werden numerische Werte angegeben. Die Ergebnisse können für die Analyse und für die Bemessung von Holzverbindungen verwendet werden.





## 1. INTRODUCTION

Since wood is assumed to be orthotropic, many theoretical paper, in the past, have been written on the subject of orthotropy. An introduction to the elasticity of anisotropic materials was covered in two classical books; one by A.E.H. Love(1), and the other by A.E. Green and Zerna(2). S.G Lekhnitskii's book(3), published in Russia in 1950 and translated into English in 1963, was devoted entirely to the problems of anisotropic bodies. Since then, many technical paper are written including some relating to the problem of concentrated load applied to orthotropic materials(4,5,6,7,8).

This paper presents an exact solution for the stresses of isotropic and orthotropic half-infinite plane loaded by an uniform load with a definite width. Fourier integral is introduced to solve the problem and the solution satisfies the equilibrium and compatibility equations.

The equations for the partial uniform load are derived independently for isotropic and orthotropic cases. The equations of orthotropy are degenerated into the expressions for isotropy when orthotropic constants are replaced by isotropic ones. The numerical results of isotropic case agree quite closely with simple results of other investigators.

The numerical results for orthotropy are evaluated for two kinds of wood and two different orientations of the grain. The types of wood considered are three layered plywood and laminated delta wood. The formal solutions are expressed in terms of closed form. The numerical results are shown in figures.

## 2. FORMULATION OF GOVERNING EQUATIONS

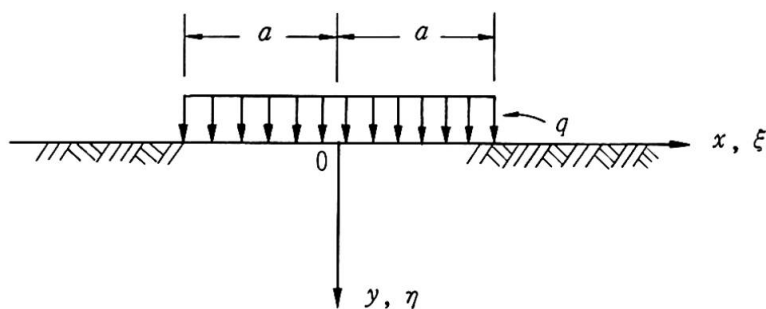

Fig. 1 Partial Uniform Load on an Half- infinite Orthotropic Material

Considering a unit thickness of a half-infinite orthotropic plane as shown in Fig. 1, the partial uniform load on  $y=0$  can be expressed in terms of Fourier cosine integral of frequency  $\beta'$  as

$$f(x) = -\frac{2q}{\pi} \int_0^{\infty} \frac{1}{\beta'} \sin(a\beta') \cos(x\beta') d\beta' \quad (1)$$

where "a" represents a half of the loaded length. With the axes of coordinates taken along the principal axes of orthotropy, the governing equation for the plane problem of orthotropy, which is equivalent to the biharmonic equation of the plane isotropy can be expressed as

$$\frac{\partial^4 \varphi}{\partial x^4} + (D_1^2 + D_2^2) \frac{\partial^4 \varphi}{\partial x^2 \partial y^2} + D_1^2 D_2^2 \frac{\partial^4 \varphi}{\partial y^4} = 0 \quad (2)$$

where

$$D_1^2 + D_2^2 = \frac{2C_{12} + C_{66}}{C_{22}}, \quad D_1^2 D_2^2 = \frac{C_{11}}{C_{22}} \quad (2a)$$

the elastic constants can be expressed in terms of the moduli as

$$C_{11} = \frac{1}{E_x}, \quad C_{22} = \frac{1}{E_y} \quad (3a)$$

$$C_{12} = -\frac{\nu_x}{E_y} = -\frac{\nu_y}{E_x}, \quad C_{66} = \frac{1}{G} \quad (3b)$$

The substitution of the assumed Airy stress function

$$\varphi = \int_0^\infty f(y) \cos(x\beta') d\beta'$$

into Eq.(2) yields

$$f(y) = A_0 e^{my} + B_0 e^{ny} + C_0 e^{py} + D_0 e^{qy} \quad (4)$$

in which

$$m = -\frac{\beta'}{D_2}, \quad n = -\frac{\beta'}{D_1} \\ p = \frac{\beta'}{D_2}, \quad q = \frac{\beta'}{D_1} \quad (4a)$$

and  $A_0$  and  $B_0$  are orthotropic constants to be found from the boundary conditions at  $y=0$ , while the constants  $C_0$  and  $D_0$  are zero because  $\varphi$  should be bounded as  $y \rightarrow \infty$ . To non-dimensionalize  $x$  and  $y$ , the following substitutions can be made.

$$\xi = \frac{x}{a}, \quad \eta = \frac{y}{a}, \quad \beta = a\beta', \quad d\beta = a d\beta' \quad (5)$$

Then,  $\varphi$  can be expressed in terms of the coordinates  $\xi$  and  $\eta$  as

$$\varphi = -\frac{2qa^2}{\pi(D_2 - D_1)} \int_0^\infty \frac{\sin \beta}{\beta^3} \left[ D_1 e^{-\frac{\beta}{D_1}\eta} - D_2 e^{-\frac{\beta}{D_2}\eta} \right] \cos(\xi\beta) d\beta \quad (6)$$

Performing integrations, the stresses are given by the closed forms as

$$\sigma_x = -\frac{q}{\pi(D_2 - D_1)} \left[ \frac{1}{D_1} \left\{ \tan^{-1} \frac{D_1(\xi + 1)}{\eta} - \tan^{-1} \frac{D_1(\xi - 1)}{\eta} \right\} \right. \\ \left. - \frac{1}{D_2} \left\{ \tan^{-1} \frac{D_2(\xi + 1)}{\eta} - \tan^{-1} \frac{D_2(\xi - 1)}{\eta} \right\} \right] \quad (7)$$

$$\sigma_y = -\frac{q}{\pi(D_2 - D_1)} \left[ D_2 \left\{ \tan^{-1} \frac{D_2(\xi + 1)}{\eta} - \tan^{-1} \frac{D_2(\xi - 1)}{\eta} \right\} \right. \\ \left. - D_1 \left\{ \tan^{-1} \frac{D_1(\xi + 1)}{\eta} - \tan^{-1} \frac{D_1(\xi - 1)}{\eta} \right\} \right] \quad (8)$$

$$\tau_{xy} = -\frac{q}{2\pi(D_2 - D_1)} \left[ -\ln \left\{ \left( \frac{\eta}{D_2} \right)^2 + (\xi - 1)^2 \right\} \right. \\ \left. + \ln \left\{ \left( \frac{\eta}{D_2} \right)^2 + (\xi + 1)^2 \right\} + \ln \left\{ \left( \frac{\eta}{D_1} \right)^2 + (\xi - 1)^2 \right\} \right. \\ \left. - \ln \left\{ \left( \frac{\eta}{D_1} \right)^2 + (\xi + 1)^2 \right\} \right] \quad (9)$$

### 3. PARTICULAR CASE OF ISOTROPY

The general case of orthotropy has been discussed in Section 2. Since isotropy is a particular case of orthotropy, all the equations presented in Section 2 must be degenerated into the expressions for isotropy when orthotropic constants are replaced by isotropic ones. In other words, when  $D_1$  and  $D_2$  become unity, the orthotropic equations should be reduced to isotropic expressions.

When  $D_1$  and  $D_2$  are replaced by unity Eqs.(7), (8), and (9) become

$$\sigma_x = -\frac{q}{\pi} \left[ \tan^{-1} \frac{(\xi + 1)}{\eta} - \tan^{-1} \frac{(\xi - 1)}{\eta} - \frac{\eta(\xi + 1)}{\eta^2 + (\xi + 1)^2} + \frac{\eta(\xi - 1)}{\eta^2 + (\xi - 1)^2} \right] \quad (10)$$

$$\sigma_y = -\frac{q}{\pi} \left[ \tan^{-1} \frac{(\xi + 1)}{\eta} - \tan^{-1} \frac{(\xi - 1)}{\eta} + \frac{\eta(\xi + 1)}{\eta^2 + (\xi + 1)^2} - \frac{\eta(\xi - 1)}{\eta^2 + (\xi - 1)^2} \right] \quad (11)$$

$$\tau_{xy} = -\frac{q}{\pi} \left[ \frac{\eta^2}{\eta^2 + (\xi - 1)^2} - \frac{\eta^2}{\eta^2 + (\xi + 1)^2} \right] \quad (12)$$

Eqs.(10), (11), and (12) coincide with the equation which the author have obtained independently for the case of isotropy. It should be also noted that the stress values given by Eqs.(10), (11), and (12) check quite closely with the numerical results of another reference(9).

### 4. NUMERICAL RESULTS FOR TIMBER

The stresses given by Eqs.(7), (8), and (9) is good for any kind of timber which exhibit physical property of orthotropy. For the sake of comparison, numerical values are calculated for two different kinds of timber and two different orientations of the grain. The kinds of timber considered are three-layered plywood and laminated delta wood. Two different orientations of the grain are strong axis in the  $x$  direction and strong axis in the  $y$  direction.

Table 1 indicates the values of elastic constants and the values of  $D_1$  and  $D_2$  for each case studies. The values for elastic constants,  $E_x$ ,  $E_y$ ,  $G$  and  $\nu_x$  are as given by Lekhnitskii(3). With these constants, the values of  $D_1$  and  $D_2$  are computed using Eq.(2a), (3a) and (3b). In the table, the grain of the surface layers of three-layered plywood and laminated delta wood are assumed to be parallel to  $x$  axis in the case of  $x$ -strong axis.

The distribution of two normal stresses and shearing stress are shown in Fig. 2, Fig. 3 and Fig. 4 for one orientation ( $x$ -strong axis) of three layered plywood. The same stresses are shown in Fig. 5, Fig. 6 and Fig. 7 for another orientation ( $y$ -strong axis) of laminated delta wood.

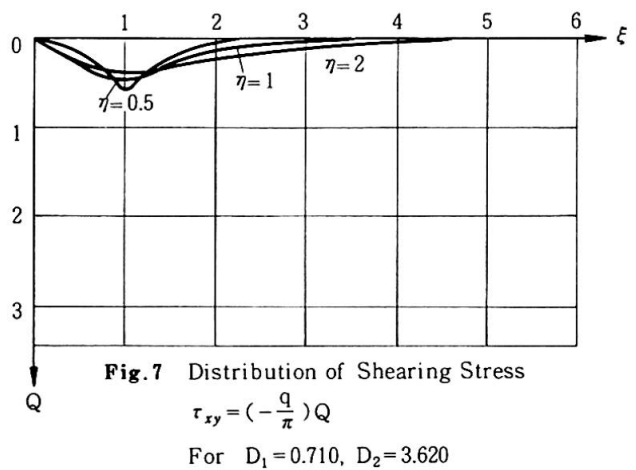
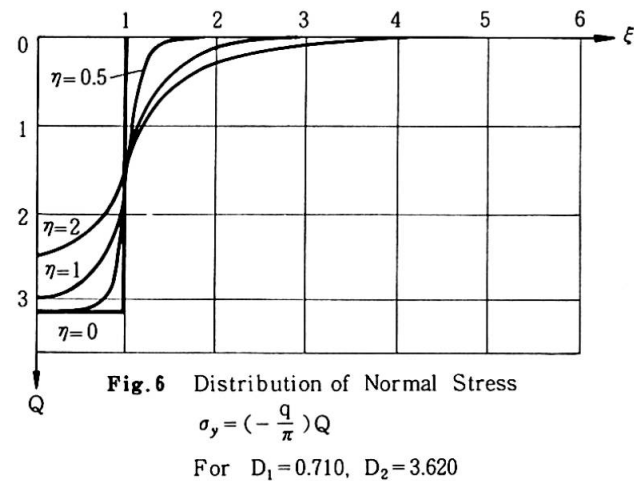
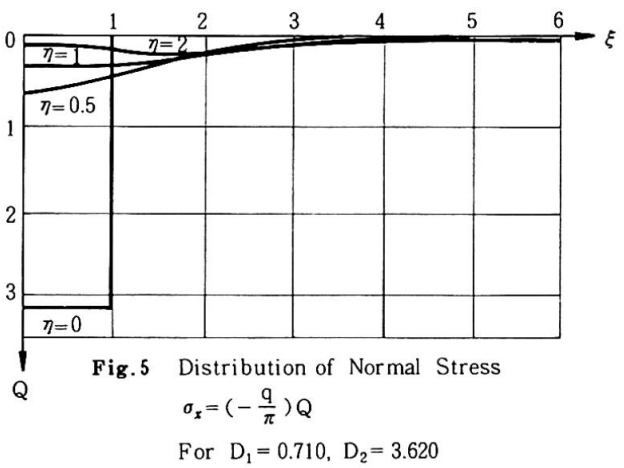
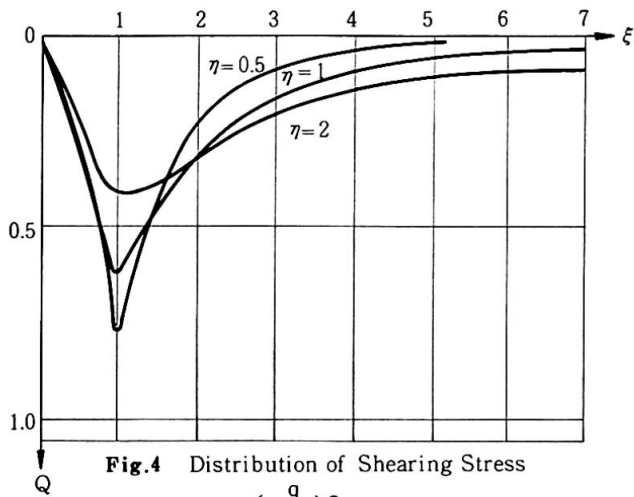
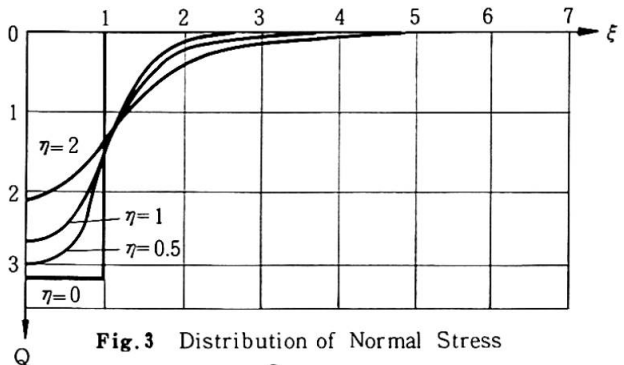
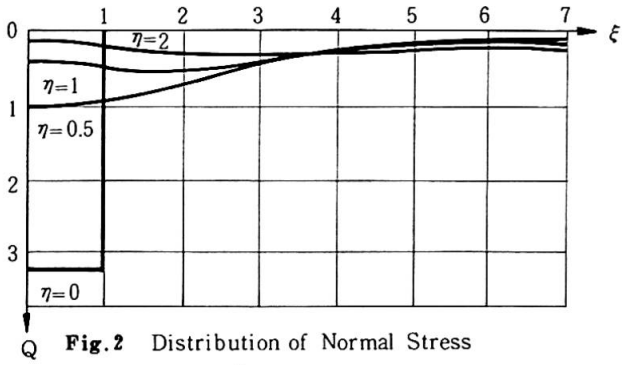



Table 1. Elastic and Orthotropic Constants

Type of Wood		Elastic Constants				Orthotropic Constants	
		$E_x$ $\times 10^{-6}$ psi	$E_y$ $\times 10^{-6}$ psi	$\nu_x$	G $\times 10^{-6}$ psi	$D_1$	$D_2$
Three-layered plywood	x-strong axis	1.71	0.85	0.036	0.1	0.25	3.0
	y-strong axis	0.85	1.71	0.07	0.1	0.34	4.12
Laminated delta wood	x-strong axis	4.3	0.67	0.02	0.31	0.872	1.415
	y-strong axis	0.67	4.3	0.031	0.31	0.71	3.62

## 5. CONCLUSION

An analytical solution for the stresses of isotropic and orthotropic materials under a partial uniform load is presented using Fourier integral and Airy stress function. The solution of orthotropy is reduced to the solution of isotropy when the orthotropic constants are replaced by isotropic ones. Numerical values are computed and reported in figures for the cases of isotropy, three layered plywood and laminated delta wood. Two orientations of grains are considered in the timber materials. The results can be applied to the analysis and design of timber connections.

## 6. REFERENCES

- (1) Love, A.E.H., The Mathematical Theory of Elasticity, Fourth Edition, Cambridge, England, University Edition, 1934.
- (2) Green, A.E., and W. Zerna, Theoretical Elasticity, Oxford, Clarendon Press, 1954.
- (3) Lekhnitskii, S.G., Theory of Elasticity of an Anisotropic Body, Hodon Day Inc., 1963.
- (4) Silverman, I.K., Orthotropic Beams Under Polynomial Loads, Journal of the Engineering Mechanics, ASCE, Oct., 1964.
- (5) Hooley, Roy F., and P.D. Hibbert, Stress Concentration in Timber Beams, Journal of the Structural Division, ASCE, April, 1967.
- (6) Goodman, James R., and Bodig, Jozsef, Orthotropic Elastic Properties of Wood; Journal of Structural Division, ASCE, Nov. 1970.
- (7) J. Chulsoo Yu, Local Effects of a Concentrated Load Applied to Orthotropic Beams, Journal of Franklin Institute, Sept. 1973.
- (8) Thompson, E.G., Goodman, J.R. and Vanderbilt, M.D., Finite Element Analysis of layered Wood systems, Journal of Structural Division, ASCE, Dec. 1975.
- (9) Structural Engineering Handbook, Japanese Society of Civil Engineers, 1974.

## II

**Design and Construction of Timber Roof in Dubai**

Projet et exécution d'une toiture en bois à Dubai

Entwurf und Konstruktion eines Holzdaches in Dubai

**R.W. TURNER**

C. Eng.

R.J. Crocker & Partners

Bromley, Kent, GB

**M. WILSON**

C. Eng.

R.J. Crocker & Partners

Bromley, Kent, GB

**SUMMARY**

Described is a simple roof system developed to take account of local conditions in the Arabian Gulf. Structural timber elements were based upon the use of local semi-skilled labour, with simple forming and nailing techniques for connections, using timber readily available locally. The net result, as well as being an efficient engineering solution, is an architecturally pleasing roof system, well suited to local conditions.

**RESUME**

On décrit un système simple de toiture, développé en tenant compte des conditions locales propres au Golfe Persique. On a conçu les éléments porteurs en tenant compte du degré de qualification de la main d'oeuvre locale: découpes simples, assemblages cloués, utilisation du bois disponible sur place. Le résultat obtenu ne se limite pas à une solution techniquement efficace: il constitue aussi une réussite architecturale bien adaptée aux conditions locales.

**ZUSAMMENFASSUNG**

Beschrieben wird ein einfaches Dachsystem das unter Berücksichtigung der lokalen Bedingungen im Arabischen Golf entwickelt wurde. Die Tragelemente wurden für die Herstellung durch angelegerte Arbeitskräfte ausgelegt, wobei einfache Formen und Nageltechniken, sowie lokal erhältliches Holz verwendet wurden. Das Ergebnis ist – neben einer wirkungsvollen Ingenieurlösung – eine ansprechende, den lokalen Bedingungen angepasste, architektonische Lösung.



## 1. INTRODUCTION

The initial development was for an infants school to become a comprehensive complex comprising Infant, Junior, Middle, Senior and Administration Blocks when complete.

Consideration was given to all types of materials, but the Architect favoured a roof shape reminiscent of local traditional tented forms and timber became the original and final choice meeting the internal aesthetic requirements.

Because of the visual scale, the architectural discipline dictated a relatively deep section for the timber roof members and therefore solid timber sections became uneconomic and unweildly. It was therefore decided to design hollow timber box beams. With the extensive use of plywood, highly dimensionally stable buildings could be constructed to serve satisfactorily in the locally severe weather conditions with the high level of internal air conditioning necessary. A decade of previous experience of building "domestic" type design for bungalow and villa residencies in the Gulf area with nailed plywood box beams (used for relatively small spans) confirmed the viability of this approach. Taking into account the local relative labour and material costs the choice was also found to be economically suitable.

## 2. SITE CONDITIONS

The site is located between Dubai and Sharjah in a typical costal desert situation. The site was originally virtually at sea level and much of the surrounding area is still under water. Ground water is always a problem and is rarely greater than a metre below the surface. The site subsoil comprises dune sand, marine sand with silt and coastal subkhas which overlie alternating layers of sandstone and limestone. There is generally a layer of medium sandstone with bands of weakly cemented sand at a minimum depth of about 3 metres below the surface which gives way to weak sands and silts until sandstone is again picked up at about 10 to 14 metres.

The upper levels consists of silty sand, brown sands with organic material and medium dense sands with layers of weak and highly permeable shells which make the construction of foundations difficult. The use of a relatively light timber construction served to reduce materially foundation problems.

## 3. STRUCTURAL DESIGN CONCEPT

The development of a lightweight timber roof allowed the vertical support system to be loadbearing blockwork which is a 'traditional' material in the Middle East. Reliance on the strength of blockwork however requires strict control. The foundations developed to become a semi-raft/ground bearing slab on the top of the fill material. This obviated costly excavation through the fill into the water laden upper layers of the site.

Figure 1\* shows a general elevation and key plan with the roofs of three teaching units and a similar staff area arranged around a larger hall with a 15m span roof. The hall is higher than its surrounding areas and has a flat roof, whilst the other four units are located around the perimeter with a central flat area. These are all stepped levels but with similar geometric properties.

\* See Page 237 for illustrations.

Figure 2 shows a typical external appearance. The general architectural requirement was for the internal appearance of a two way grid system. The roof covering had to be light and simple and it was elected to use double sided insulated ply panels with 'Hypalon' patent roof covering.

In the teaching and staff units the main architectural grid is 1.5 m and it can be seen that there are two types of spanning roof member. One is a full frame double bent beam 7.5 m long, the other a half frame single bent beam 4.5 m long. There are of course various detail variations on these two basic elements, but a single design was possible to control the whole structural concept.

Figure 3 shows details of a typical 7.5 m span bent and Figure 4 the 15 m main hall beams.

It was decided very early on in the conception that a timber structure of this type had to be largely insitu in its execution. It was also apparent early in negotiations that local contractors would be involved in tendering. Therefore any rigid design requirements or premanufactured units would make local participation untenable.

Two basic decisions were therefore made:

- A. The roofs would not be designed as two way spanning grids due to the difficulties in construction the members to satisfy complex design requirements.
- B. All details had to be such that site manufacture would be possible therefore all units would be designed as nailed elements. Glue would not be used because control is difficult and pressure glueing is not viable due to lack of suitable equipment also the shelf life of glues in such climates is very limited.

These two decisions required the beams to be designed as self supporting single units with infill secondary units at right angles, once the infill units and roof panels were in place the whole structure would then become a complete stiff diaphragm to transmit wind loads to foundations. Figure 5 shows local workmen engaged on site manufacturing.

#### 4. DETAIL DESIGN CONSIDERATIONS

All design was carried out in accordance with the British Code CP112 Part 2 albeit the code is very limiting in its coverage of members of the type we wished to design.

The type of timber used had to be carefully controlled. Again only visual<sub>2</sub> grade selection could be carried out locally so a grade 65 with basic  $9\text{N/mm}^2$  of category J2 hardwood, with softwood alternatives, was selected for the design. In the event, hardwood was eventually selected for the tension members and softwood for all other parts. Ply webs were hardwood faced.

Apart from some few experimental papers there are very little published data on nailed beams. A lot of reference literature was available from the Plywood Manufacturers Association, British Columbia. With the available information the design was developed from basic first principles and nail stresses calculated from the rolling shear relationship in the plywood webs. This appears to give sensible results and with the use of improved annular ringed nails and predrilled holes the design and detailing of the units was built up.

The main beams, being double bents were designed for moment development about the knees and in these instances double sided shear connectors were used to transfer the related shear forces between separate sections of timber.

Allowance was made in the detailing for a notional amount of relaxation due to long term relief from shrinkage and deflection and therefore horizontal forces were considered at the bearing locations of all main beams. Stiffening effect of the transfer members was accounted for and these infill members were designed with continuous splices at main beam connection points with a notional 25% of the main moment values allowed. No direct account was taken of the stressed diaphragm effect of the roof panel especially as these were separate panels, except that the panels were laid with discontinuous joints and horizontal thrusts were considered as suitably dissipated into bearing points.

At the bearings, the main double bent beams were connected into the top of an insitu concrete column reinforced to accept the lateral thrusts from the beams. Where nominal units occurred at hipped ends, at right angles to the main beams, the thrusts were allowed to be spread through the whole diaphragm and accepted on the blockwork.

All beams were fixed onto timber wall plates using metal angles which were rag bolted into the blockwork or columns to allow for thrusts and wind uplift forces.

The hall beams were straightforward large span beams at 1.5 m centres and spanning across 15 metres. The bearings were haunched and had cantilever spurs flying out beyond the external wall face to afford sun shading effects to the high level clerestory windows. Movement was allowed at one end of the bearing.

Loadbearing blockwork generally was solid but where connections were required, hollow blocks were used with the bolts bedded into concrete in the block cavities. All beams were constructed with cambers to allow construction deflection and also to give drainage falls on the areas of flat roofs bounded by the pitch sides. Expansion joints were provided between the various units and these joints were reflected in blockwork and in the semi raft foundation.

The walls consisted of 200 mm internal loadbearing leaf with 50 mm cavity and 100 mm non-loadbearing outer skins. The outer skin was split every three metres to allow thermal movement independent of the remaining structure.

The last illustration Figure 6 shows the completed school in occupation.

## 5. CONCLUSIONS

With the difficulties encountered in the Gulf States, with aggregate control workmanship and chloride contents in concrete, it is felt that the solution to the problems on this particular structure indicate that it is possible to construct economic and aesthetically appealing structures using natural timbers. We have, therefore, demonstrated that the economic structural use of engineered timber is structurally satisfying and the end product architecturally pleasing.

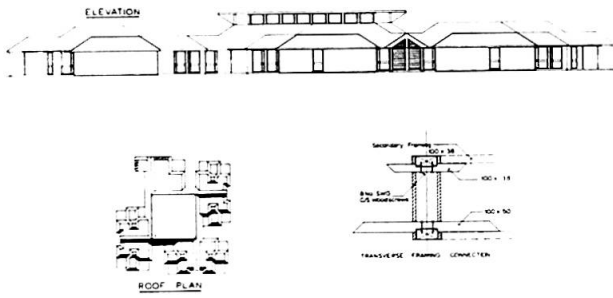

Fig.1: Key plan and elevation.



Fig.2: Photograph of typical elevation.

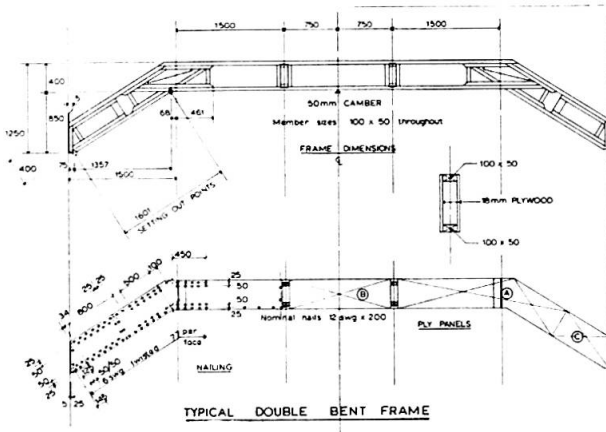

Fig.3: Drawing of 7.5m span bent.

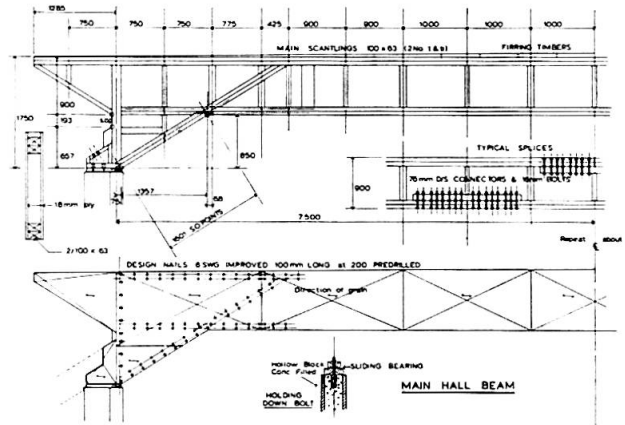

Fig.4: Drawing of 15m span main hall beam.

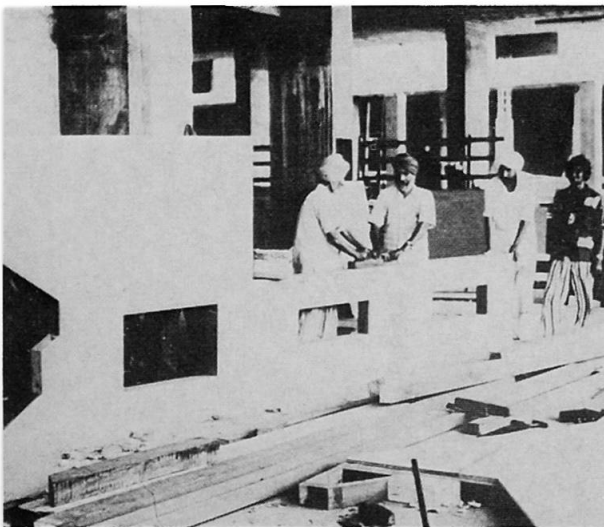

Fig.5: Photograph of fabrication on site.

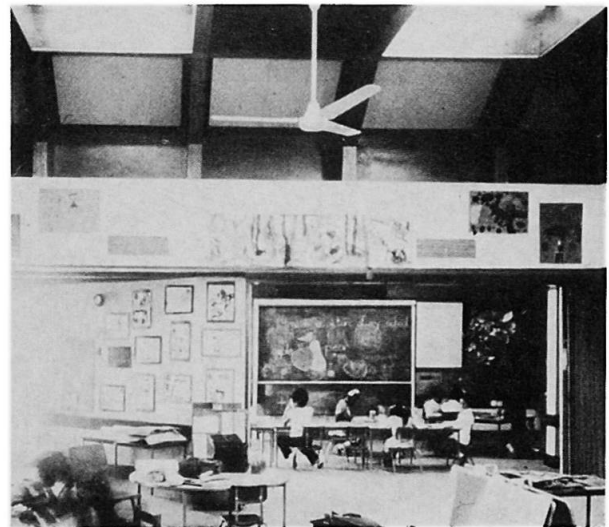

Fig.6: Photograph of interior of completed school.

Leere Seite  
Blank page  
Page vide

**II****Passerelle pour piétons en bois lamellé-collé**

Fussgängerbrücke in Holzleimbauweise

Pedestrian Footbridge in Glued Laminated Wood

**L. MAHIEU**

Inspecteur Général de Ponts et Chaussées

Ministère des Travaux Publics

Bruxelles, Belgique

**RESUME**

L'évolution des goûts et des idées conduit actuellement à un retour vers l'utilisation de matériaux naturels tels que le bois. C'est ce qui nous a décidé à choisir ce matériau pour construire une passerelle pour piétons dans la banlieue de Bruxelles. Mais pour utiliser au mieux ce matériau traditionnel, on a eu recours à des techniques modernes.

**ZUSAMMENFASSUNG**

Der heutigen Tendenz, natürliche Baustoffe zu verwenden folgend, wurde Holz zum Bau einer Fussgängerbrücke in der Brüsseler Vorstadt gewählt. Um diesen traditionellen Baustoff optimal zu nutzen, wurden moderne Techniken eingesetzt.

**SUMMARY**

The evolution of tastes and ideas leads presently back to natural materials such as wood. Therefore, we decided to choose this material for the construction of a pedestrian footbridge in the suburbs of Brussel. This traditional material was used in conjunction with the latest specialized techniques.





## 1. INTRODUCTION.

Depuis quelques années, on constate en Belgique, comme ailleurs, une prise de conscience marquée vis-à-vis de l'importance d'un environnement convenable, d'un cadre de vie adéquat.

L'homme engendré par la nature doit retrouver dans celle-ci certains éléments naturels pour vivre, s'épanouir et être heureux.

C'est sans doute ce qui explique le succès accru des matériaux naturels.

C'est dans cet esprit que nous avons choisi le bois pour construire une passerelle pour piétons dans la banlieue de Bruxelles, alors que nous n'avions plus utilisé ce matériau depuis des dizaines d'années pour des constructions de ce genre.

Mais pour utiliser au mieux ce matériau traditionnel, on a eu recours à des techniques modernes (bois lamellé-collé, imprégnation à base de Chrome - Fluor - Cuivre).

## 2. DESCRIPTION GENERALE.

La superstructure est à tablier intermédiaire.

L'ouvrage comporte deux travées respectivement de 30 et 28 mètres de longueur. Il est isostatique du type cantilever, une articulation se trouve à 5 m de l'appui central.

Les poutres sont constituées de deux éléments en section courante et de trois dans la zone centrale au-dessus et à proximité de la pile. Leur hauteur varie de 1,45 à 1,70 m.

Elles sont reliées par des contreventements en tiges d'acier ainsi que par des entretoises qui, disposées tous les 5 m environ, supportent trois longrines.

La pile pendulaire s'appuie sur un socle de 1,5 m de hauteur à l'abri des chocs éventuels des véhicules.

Toute la structure est en bois lamellé-collé, épicéa et sapin rouge du nord, sauf le plancher et le garde-corps qui sont en bois de hêtre du pays. Le plancher est constitué de planches posées de chant et assemblées par paquets au moyen de barres en polyamide. Les lamelles ont été collées au moyen d'une résine phénolique. La surface des pièces de hêtre constituant le garde-corps a été soigneusement poncée, en vue d'éviter la formation d'échardes.

## 3. DISPOSITIONS CONSTRUCTIVES.

Les dispositions constructives ont évidemment été étudiées avec le souci de favoriser l'évacuation de l'eau de ruissellement, d'éviter la stagnation d'eau, d'empêcher l'infiltration par capillarité; de ventiler tous les éléments; les poutres principales sont coiffées d'un profil en aluminium; des feuilles de butyl sont intercalées pour éviter les contacts bois sur bois; les pièces de bois ont des surfaces de contact réduites au minimum; le plancher est ajouté; les appuis des poutres sont surélevés pour faciliter l'écoulement de l'eau et éloigner le bois du sol de fondation; ....etc.

De plus, le bois est protégé par une imprégnation en profondeur d'une solution aqueuse de sels à base de Chrome - Fluor - Cuivre appliquée avant collage des lamelles et par un traitement chimique superficiel.

Un autre type de problème spécifique des constructions en bois, c'est celui des appuis.

La liaison " Cantilever " est réalisée par un cadre métallique s'appuyant sur la face supérieure de l'extrémité de l'encorbellement de la poutre en porte-à-faux et dans lequel vient se loger l'extrémité de la poutre isostatique à supporter.

Avec ce système, on évite les découpes dans les lamelles et, par conséquent, les efforts de traction perpendiculairement à celles-ci. Les efforts horizontaux sont transmis de poutre à poutre par une bielle en acier située au niveau de l'appui inférieur.

L'appui fixe est entièrement métallique. Un sabot en acier permet la rotation de la poutre sur sa fondation et le mouvement relatif se fait au contact métal - métal.

Ceci supprime entre l'acier et le bois, des frottements qui sont souvent causes de détérioration du bois.

Tous les autres appuis sont réalisés avec du néoprène fretté adapté aux problèmes du bois.

Tous les autres appuis sont réalisés avec du néoprène fretté adapté aux problèmes du bois.

Les assemblages métalliques sont galvanisés à chaud et recouverts d'une peinture protectrice. Ils ont été conçus de façon à permettre le démontage de la passerelle.

Les boulons et les rondelles sont en acier inoxydable 18/8.

Compte tenu de l'anisotropie des propriétés mécaniques des pièces en bois (grande résistance dans le sens axial des fibres et mauvaise résistance dans le sens radial des fibres) la conception des assemblages et appuis a, bien entendu, été établie de manière à éviter les efforts transversaux et à renforcer les liaisons par des pièces métalliques là où ils sont inévitables et importants.

Les plaques de répartition des charges aux appuis sont de dimensions calculées en vue de limiter les contraintes à la valeur admissible de 2500 KN/m<sup>2</sup>.

La grande légèreté (6 KN/m<sup>3</sup>) impose des liaisons supplémentaires pour empêcher le risque de soulèvement, mais celles-ci ne doivent pas s'opposer au fonctionnement normal des appuis.

Grâce à cette grande légèreté, la structure a pu être complètement préfabriquée en usine, amenée en deux parties et mise en place par des grues de type courant.

#### 4. ASPECT ECONOMIQUE ET PERSPECTIVES D'AVENIR.

Le prix de la passerelle est du même ordre de grandeur que celui de constructions semblables en béton ou en acier.

Les solutions en bois pourraient être compétitives vis-à-vis des ponts en béton pour les petites portées et vis-à-vis des ponts métalliques pour les grandes portées. Mais, compte tenu du

caractère expérimental de cette première réalisation, il n'a pas été possible de résoudre ici tous les problèmes techniques de la façon la plus économique.

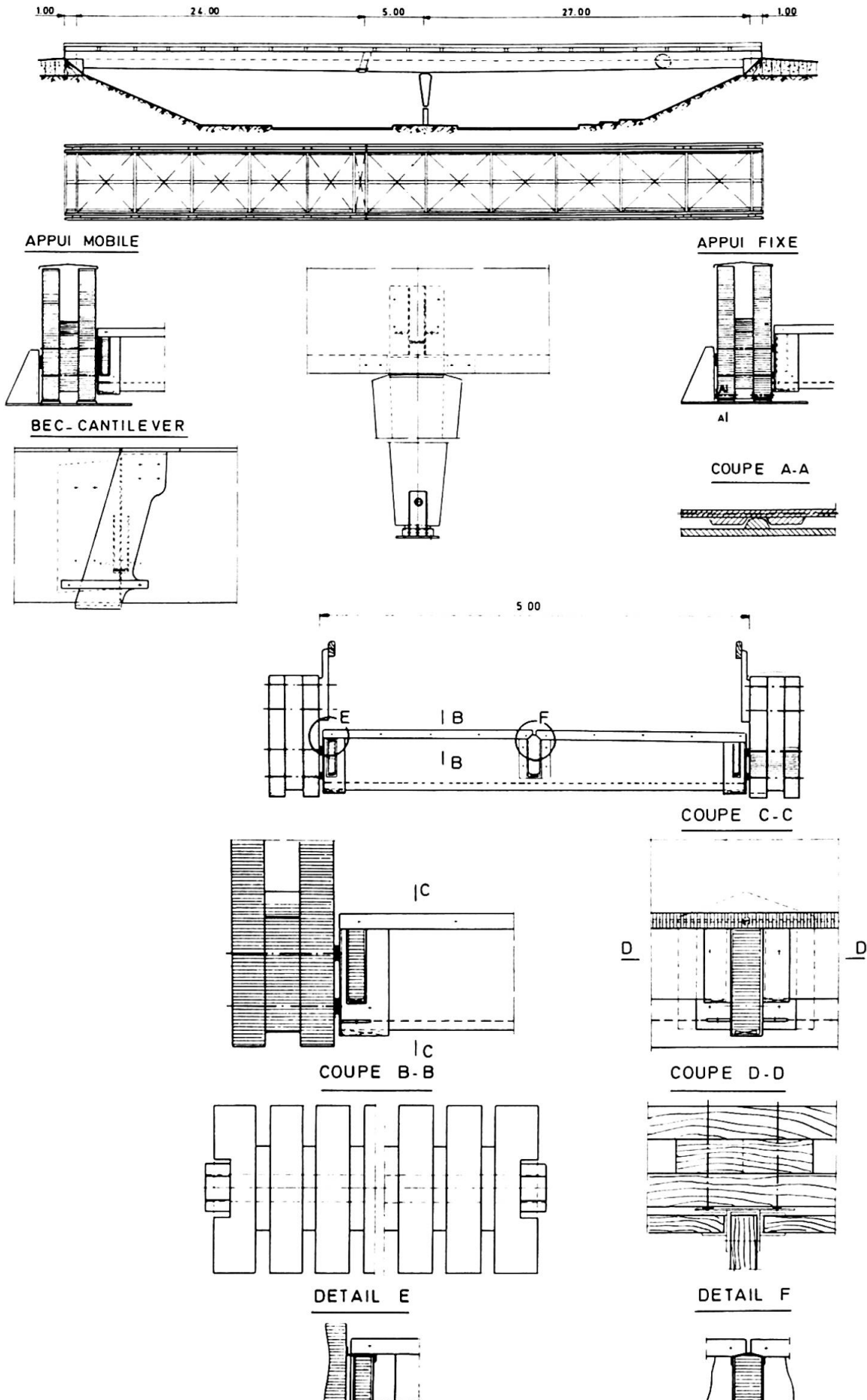

## II

**Hängedach in Holzrippenbauweise**

A Timber Construction as Hanging Roof

Toiture suspendue construite en bois lamellé-collé

**JULIUS NATTERER**

Prof., Dipl.-Ing.

Lehrstuhl für Holzkonstruktionen, ETH

Lausanne, Schweiz

**ZUSAMMENFASSUNG**

Es wird über die Planungsbedingungen und über die Dachkonstruktion einer zurzeit in Wien im Bau befindlichen Industrie-Rundhalle mit 170 m Durchmesser informiert. Das Dach wird von einer hängenden Holzrippenschale in Brettschichtholzbauweise gebildet.

**SUMMARY**

The report informs about the conditions of planning and about the construction of a hanging roof for an industrial hall with a diameter of 170 m under construction in Vienna. The roof consists of a hanging shell by glued laminated timber lamelles.

**RESUME**

Des renseignements sont donnés sur les conditions de planification et sur la construction de la couverture d'une halle industrielle circulaire de 170 m de diamètre, à Vienne, Autriche. La toiture est formée d'un voile mince nervuré en bois lamellé-collé.



Der moderne Ingenieurholzbau bietet eine Reihe von Vorteilen die es ihm ermöglichen, auch bei klassischen Ingenieuraufgaben im heutigen Hochbau überzeugende Lösungen anzubieten. Einen neuerlichen Beweis dafür, dass mit brettschichtverleimten Bindern grosse Raumdimensionen unter Berücksichtigung wirtschaftlicher und gestalterischer Aspekte überbrückt werden können, liefert ein gegenwärtig im Bau befindliches Hängedach für eine Recycling-Anlage am Stadtrand von Wien.

### Die Bauaufgabe

Charakter und Zweckbestimmung des Bauwerkes sind nicht alltäglicher Art, handelt es sich doch hierbei um eine Anlage für die Rohstoffrückgewinnung aus Müll. Bei der Projektierung musste deshalb von aussergewöhnlichen Bedingungen und Grössenordnungen ausgegangen werden:

- Die vorgesehene Nutzung erforderte die Ueberdachung einer 23000 m<sup>2</sup> grossen Grundfläche, und zwar unter Einsatz von möglichst wenig Stützen. Dadurch sollte zukünftigen, heute noch nicht absehbaren Entwicklungen bei den maschinellen Einrichtungen Rechnung getragen werden.
- Aus der Eigenart der Nutzung resultierten spezielle Anforderungen an das Holz-Tragwerk bezüglich Feuerwiderstand und Haltbarkeit bei aggressiven Raumklimata.
- Auf die Interessen der Bauherrschaft abgestimmt, fiel die Terminierung für Projektierung und Realisierung sehr kurzfristig aus: Planungsbeginn für die Variante in Holz war April 1980, mit der Herstellung der Binder wurde Anfang Juni begonnen, die Montage auf der Baustelle begann Ende Juli; die Fertigstellung der Dachkonstruktion ist bis Ende des Jahres 1980 vorgesehen.

### Statisches System

Das Primärtragsystem besteht ausschliesslich aus brettschichtverleimten Elementen, und zwar aus 48 radial angeordneten Hängerippen (Länge: ca. 102 m - entsprechend den möglichen Transportlängen zusammengesetzt aus drei Teilen - Höhe: 80 bis 110 cm, Breite: 20 cm - pro Rippe zwei biegesteife Baustellenstösse mit Nagelplatten und Gelenkwellen) sowie aus 11 kreisförmig angeordneten Pfettenringen (Querschnitte: 20/30, 2 x 12/45 und 20/60 cm). Die Spannweite der Hängerippen im Grundriss beträgt 82 m, und zwar vom zentralen Auflager in Turmhöhe (ca. 67 m) bis zu den Betonfundamenten (Traufhöhe: ca. 11 m) gerechnet. Die Form der Hängerippen ist so gewählt, dass sie bei symmetrischen Lasten - ohne Berücksichtigung der Ringwirkung - momentenfrei sind und nur Zugkräfte zu übertragen haben.

Durch die zug- und druckfesten Verbindungen der Ringpfetten, sowohl untereinander wie auch mit den Hängerippen, lässt sich das Primärsystem als räumliches Hängenetz charakterisieren. Die diagonal verlegte, schachbrettartig versetzte Bohlenlage gibt dem Stabwerk eine zusätzliche Diagonalsteifigkeit. In den unteren Feldern sind zur Verstärkung der Bohlenlage gekreuzte Windverbände aus Brettschichtholzprofilen angeordnet.

Sämtliche Anschlüsse sind genagelt. Während für die biegesteifen Stösse der Hängerippen und auch für die Aufhängepunkte Nagelbleche und Gelenkbolzen eingesetzt werden, wird die Befestigung der Bohlenlage auf den Rippen teilweise mit dünnen durchnagelbaren Blechen verstärkt. Die durch die Nagelanschlüsse zu übertragenden Kräfte liegen in den Grössenordnungen zwischen einigen KN und max. 12 MN (120 Mp oder Tonnen). Für die tragenden Teile der Konstruktion und für die Bohlenlage wurden folgende Holzkubaturen verwendet: ca. 1900 m<sup>3</sup> Brett-



schichtholz, 110 m<sup>3</sup> Konstruktionsholz sowie 1020 m<sup>3</sup> Nadelholz-Schalung (40 mm). Das Projekt beweist, dass der Ingenieurholzbau auch bei den grossen Spannweiten des Industriebaus mit Stahlkonstruktionen konkurrieren kann, und dass Holzkonstruktionen in besonderem Masse geeignet sind, die modernen Tragwerkskonzeptionen der zugbeanspruchten Konstruktion zu verwirklichen. An dem Projekt sind u.a. folgende Planungsbüros beteiligt: Architektur: Lukas Mathias Lang, Wien; Stahlbeton: Ingenieurbüro Jakubetz, Wien; Holzdach: PNP Planungsgesellschaft Natterer und Partner mbH, München.

### Ausblick

Hängeschalen in Holzrippenbauweise sind schon längere Zeit im Gespräch. Ausser einigen Projekten gibt es auch schon gebaute Beispiele, so die Hängeschale für die Bundesgartenschau 1969 in Dortmund mit einer Spannweite von 61 m (Architekt: Behnisch; Ingenieure: Scholz, Natterer).

In der zukünftigen Entwicklungs- und Forschungstätigkeit am Lehrstuhl für Holzkonstruktionen bzw. Institut de statique et structures I-BOIS an der ETH Lausanne wird den Grundlagenuntersuchungen zu den speziellen Problemen von Hängeschalen in Holz ein hoher Stellenwert eingeräumt. So sind z.B. Messungen an dem Wiener Dach vorgesehen und der Bau eines Prototyps einer Hängeschale für kleinere Spannweiten in Lausanne ist im Gespräch.

Durch die zusätzliche Unterstützung seitens der Schweizer Bundesregierung wird es möglich, die weitergehenden Untersuchungen spezieller Fragestellungen verstärkt fortzusetzen und sowohl die praktischen als auch die theoretischen Ergebnisse in geeigneter Form der Öffentlichkeit zugänglich zu machen.



Bild 1: Vom turmhohen Firstpunkt (Endhöhe 67 m) bis zu den im Kreis angeordneten scheibenförmigen Betonauflagern (Traufhöhe 11 m) werden die 48 Hängerippen eine freie horizontale Spannweite von 82 m überbrücken



Bild 2: Mit den erforderlichen Anschluss- und Stossverbindungen versehen, werden auf der Baustelle jeweils 3 Brettschichtelemente zu einer 102 m langen Hängerippe montiert



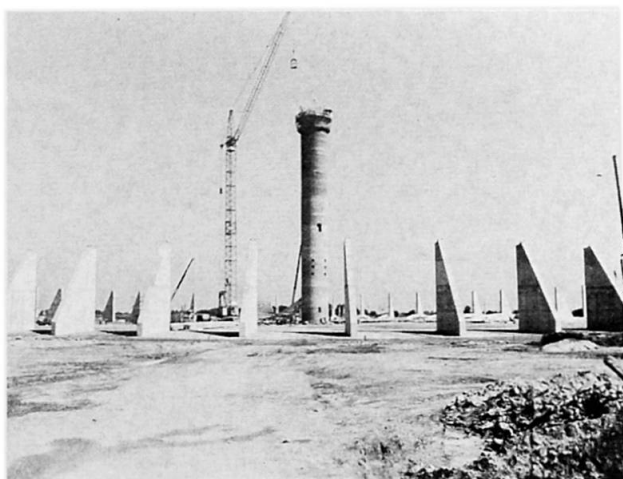

**Bild 3:** Die fertigmontierten Dachsegmente, einschliesslich der Sparren und der vernagelten Bohlenlage, werden durch 3 Kräne eingehoben

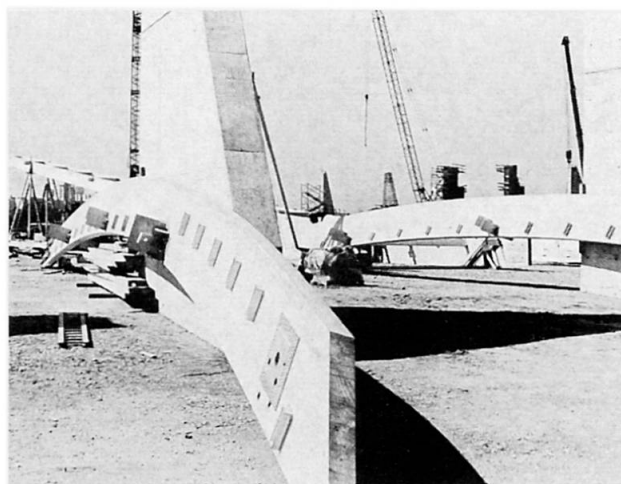
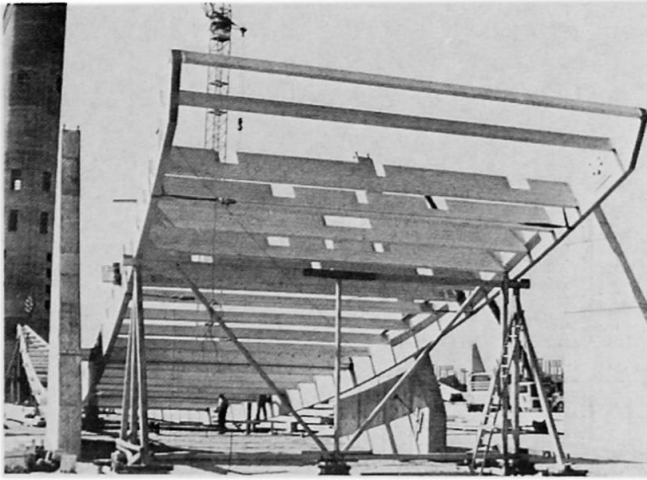
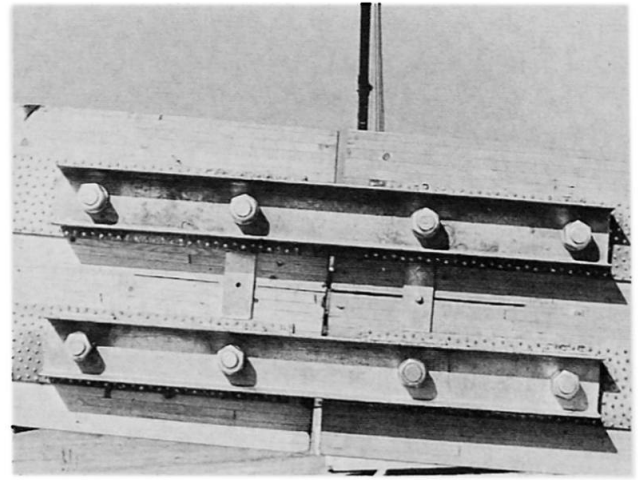

**Bild 4:** Ausbildung der biegesteifen Stösse mit vollausgenagelten Blechen sowie Gelenkbolzverbindungen

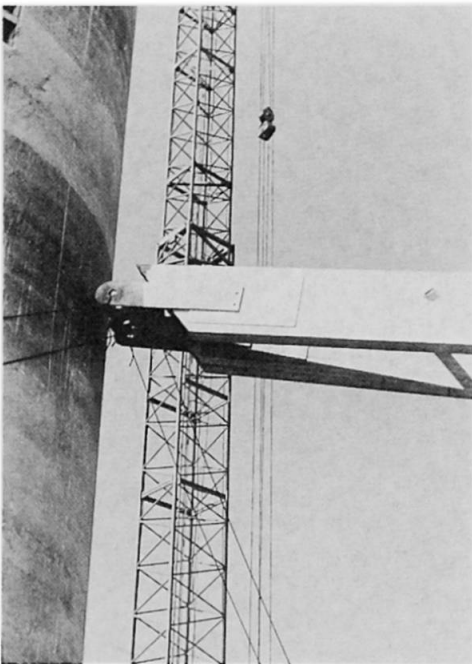

**Bild 5:** Anschlussdetail eines Dachsegmentes im Auflagerbereich des Turmes

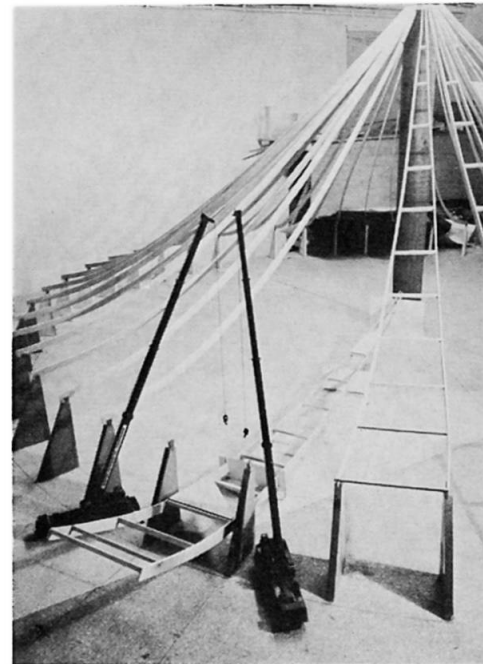

**Bild 6:** Am Montagemodell (1:50) lässt sich die Struktur des Hängerippendaches (abgewickelte Fläche: ca. 29000 m<sup>2</sup>) ablesen

**II****Deformability of Composite Timber Beams**

Déformabilité des poutres composées en bois

Deformabilität von zusammengesetzten Holzträger

**SRDAN TURK**

Professor D.Sc.

University of Edvard Kardelj

Ljubljana, Yugoslavia

**SUMMARY**

The report deals with the simple method for calculation of the bending and buckling behaviour of composite bars. The method gives, for the praxis, enough exact results considering any number of composite parts. The same principles can also be used for the calculation of the deformability of torsional beams and for the control of torsional stability (torsional buckling, lateral buckling).

**RESUME**

Cet article présente une méthode simple permettant de calculer la flexion et le flambement des poutres composées en bois. Les résultats obtenus sont suffisamment exacts pour une utilisation pratique, quel que soit le nombre de composants. Les mêmes principes sont utilisables pour le calcul des phénomènes de torsion (déformabilité, flambement de torsion, déversement).

**ZUSAMMENFASSUNG**

Dargelegt wird eine einfache Methode für die Berechnung des Biege- und Knickverhaltens zusammengesetzter Holzstäbe. Die Methode bietet für die Praxis genügend genaue Resultate für eine beliebige Zahl zusammengesetzter Teile. Dieselben Prinzipien sind ebenfalls anwendbar für die Berechnung der Verformung von tordierten Trägern und für die Kontrolle der Torsionsstabilität (Drillknicken, Kippen).

1. THE BASIC PRINCIPLES FOR THE CALCULATION OF THE DEFORMABILITY OF COMPOSITE TIMBER BEAMS.

The starting point of our calculation is Fig.1, where in Fig.1/a deformations and stresses for a stiff-jointed beam are presented, in Fig.1/b an elastically jointed beam, and in Fig.1/c a composite beam without fasteners are presented. If  $r_i$  is the reduction-factor:

$$\sigma_v = \sigma_{io} + \sigma_{iv}, \sigma_{io} = r_i \cdot \sigma_{ioa}, \sigma_{iv} = \sigma_{iva} = \sigma_{ivb} = \sigma_{ivc} = \sigma_{vc}, R = \text{const} \quad \dots/1$$

Acc. to Fig.2 the stress  $\sigma = \epsilon \cdot E$  for the distance "y" from the neutral axis and thus  $\sigma_{ioa} = C \cdot y_i$  and  $\sigma_{iva} = C \cdot y_{iv}$ ,  $C = E/R$  and:

$$\sigma_v = C \cdot (y_{iv} + r_i \cdot y_i), y_{iv} = y_v - y_i, C = E/R \quad \dots/2$$

The moment, taken over by the beam, if the beam has "n" parts and  $A$  is the complete area of the cross-section, and  $A_i$  the area of the part "i"

$$M = \int_A \sigma_v \cdot y_v \cdot dA_i = C \cdot \left\{ \sum_1^n \int_{A_i} y_{iv}^2 \cdot dA_i + \sum_1^n r_i \cdot y_i^2 \cdot A_i \right\} \quad \dots/3$$

$$M = C \cdot \left( \sum_1^n I_{ti} + \sum_1^n r_i \cdot I_{Ti} \right) = C \cdot I_e = E \cdot I_e / R, I_{ti} = \int_{A_i} y_{iv}^2 \cdot dA_i, I_{Ti} = y_i^2 \cdot A_i$$

where  $I_e$  is the effective moment of inertia, and if we denote

$$I_{ae} = \sum_1^n r_i \cdot I_{Ti}, I_{am} = \sum_1^n I_{Ti} \text{ (m...mathematical)}, I_{ti} = \frac{b_i \cdot h_i^3}{12} \quad \dots/4$$

and

$$I_e = \sum_1^n I_{ti} + I_{ae}, I_m = \sum_1^n I_{ti} + I_{am} \text{ (=math.mom.of in.)} \quad \dots/5$$

Now  $r_i$  should be established. This can be simplified by introducing:

$$r_i = q \cdot k_i, 1,00 \geq q \geq 0,00, 1,00 \geq k_i \geq 0,00; q = \text{const.} \quad \dots/6$$

2. THE CALCULATION OF THE FACTORS OF REDUCTION AND OF THE APPROPRIATE NUMBER OF FASTENERS.

The Eq.3 can be composed so that the moment  $M$  is divided into the local moments  $M_i = C \cdot I_{ti}$  and into the associated moment  $M_a = C \cdot I_{ae}$ , i.e.  $M = \sum_1^n M_i + M_a$ . If for the moment  $M_a$  first the calculation of  $ae$  his

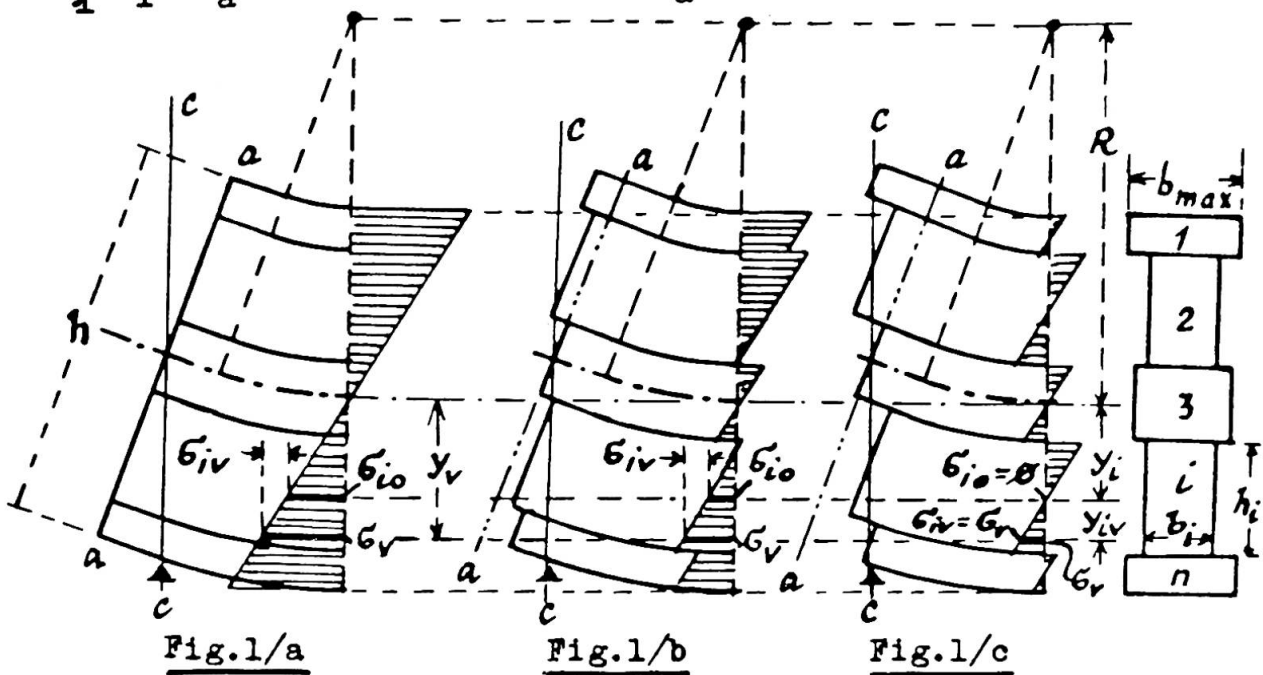

deformation is considered with the consideration of the effective moment of inertia  $I_{ae}$ , and then of the mathematical moment of inertia  $I_{am}$ , here including the deformations with regard to the transversal forces, it follows:

$$f = M_a \cdot L^2 / K \cdot E \cdot I_{ae} = M_a \cdot L^2 / K \cdot E \cdot I_{am} + a \cdot M_a / A_o \cdot G_d \quad \dots/7$$

Here is  $E$  the modulus of elasticity for timber,  $L$  is the span (Fig. 3/a, b),  $K$  is the factor dependent on the shape of the moment line, for the praxis,  $K \approx 10$  is sufficient; "a" is for a rectangular cross section  $a=1, 2$ , and  $A_o$  is the area of the cross-section outlined rectangle;  $G_d$  is the reduced shear modulus (deformability of fasteners!). From Eq. 7 the value for  $I_{ae}$ :

$$I_{ae} = I_{am} / (1+m), \quad m = a \cdot I_{am} \cdot K \cdot E / L^2 \cdot A_o \cdot G_d \quad \dots/8$$

Supposing that all  $k_i$  are equal to 1,00, i.e.  $r_i = q = \text{const.}$ , acc. to Eq. 4:  $I_{ae} = q \cdot I_{am}$  and finally (acc. to Eq. 8):

$$q = 1 / (1+m), \quad \text{for } k_i = \text{const.} = 1,00, \quad r_i = q \quad \dots/9$$

The reduced shear modulus  $G_d$  is shown in Fig. 4. In Fig. 4/a we have the real example with  $G=G$  and the displacement  $x_f$ , in Fig. 4/b we have the fictitious example  $G \rightarrow G_d$ , and the same displacement  $x_n$ , but now without the dislocation of the elements "i" and "j", which is acc. to Fig. 4/a equal to  $z_{pij}$  ( $\tau_{ji} = \tau_{ij} \cdot s_{ij} / s_{ji}$ !):

$$x_f = \tau_{ij} \cdot d_{ij} / G + \tau_{ji} \cdot d_{ji} / G + z_{pij} = x_n = \tau_{ij} \cdot d_{ij} / G_d + \tau_{ji} \cdot d_{ji} / G_d \quad \dots/10$$

and:

$$G_d = G / (1 + z_{pij} \cdot G / H_{ij} \cdot \tau_{ij} \cdot s_{ij}), \quad H_{ij} = d_{ij} / s_{ij} + d_{ji} / s_{ji} \quad \dots/11$$

The dislocation  $z_{pij}$  at the shear force  $P_{ij}$  in one fastener, which have the allowable loading  $N_{sij}$  and the dislocation with regard to this loading  $z_{nij}$ , is then:  $z_{pij} = z_{nij} \cdot P_{ij} / N_{sij}$ . If there are  $n_{sij}$  fasteners on the length of  $100 \text{ cm}$ , we get  $z_{pij} = z_{nij} \cdot \tau_{ij} \cdot s_{ij} \cdot 100 / N_{sij} \cdot n_{sij}$ . By introducing this in Eq. 11, and regarding  $Q_{ij} = N_{sij} \cdot H_{ij} / 100 \cdot z_{nij}$  we get:

$$G_d = G / (1 + G / Q_{ij} \cdot n_{sij}) = G_{do} / (1 + G_{do} / G), \quad G_{do} = Q_{ij} \cdot n_{sij} \quad \dots/12a$$

To have the same  $G_d$  along the whole depth of the beam,  $G_{do} = \text{const.}$ :

$$Q_{ij} \cdot n_{sij} = Q_{ts} \cdot n_{sts}, \quad \text{i.e. } n_{sij} = n_{sts} \cdot Q_{ts} / Q_{ij} \quad \dots/12b$$

Here is  $t$ - $s$  any jointed plane, where we can take any number of fasteners ( $n_{sts}$  on  $100 \text{ cm}$ ).

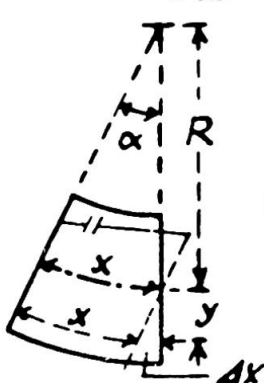

Fig. 2

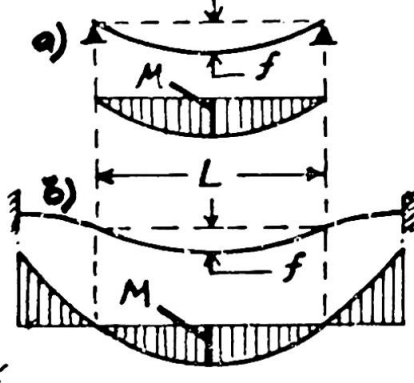

Fig. 3/a, b

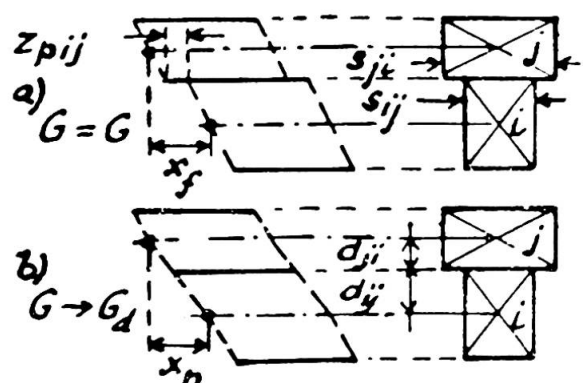

Fig. 4/a, b

If we want less fasteners  $n'$  on boundary areas, we take into account  $r \rightarrow r' = q \cdot k$ ,  $k < 1,00$  any values, for  $i=t, i=s$  recommendable  $k_t = k_s = 1,00$ . In this case the shear force in the joint  $i-j$  diminishes from  $P = \tau_{ij} \cdot s_{ij} \cdot \Delta L$  to  $P' = \tau'_{ij} \cdot s_{ij} \cdot \Delta L$ , i.e. the factor of reduction of fasteners  $t_{ij} = \tau'_{ij} / \tau_{ij}$ , so (r...boundary [edge] element):

$$t_{ij} = \frac{r}{\sum_j k_p} \cdot \frac{A_p \cdot y_p}{\sum_j A_p \cdot y_p}, \quad p = j, j+1, j+2, \dots, r \quad \dots/13$$

The second correction arises because of the increase of deformations of fasteners and is acc. to Fig.5 equal  $c_{ij}$ :

and: 
$$c_{ij} = (y_j - y_i) \cdot (1 - q) / \{y_j \cdot (1 - k_j \cdot q) - y_i \cdot (1 - k_i \cdot q)\} \quad \dots/14$$

$$n'_{sij} = n_{sij} \cdot t_{ij} \cdot c_{ij} \quad (n_{sij} \text{ for } k_i = 1,00, \text{ Eq.12/b}) \quad \dots/15$$

In Eq.7, the values "a" should be presented also for other cross-sections. To avoid the known complicated equation, we take (Fig.6):

$$a \doteq 1,2 \cdot b_{\max} \cdot \sum H_{ij} / \sum (d_{ij} + d_{ji}) \quad \dots/16$$

3. APPLICATIONS OF THE GIVEN METHOD IN BENDING, BUCKLING AND TORSION.

In bending, the effective moment of inertia  $I_e$  (from Eq.5) is taken for the calculation of deformations. To calculate the stresses we put from Eq.3 the value  $C = M/I_e$  in the Eq.2 and we get:

$$\sigma_v = (M/I_e) \cdot (y_{iv} + r_i \cdot y_i) \quad \dots/17$$

A special example is a lattice beam, flanged additionally. Here the influence of diagonals and verticals is exchanged by the web of the width  $b''$  (which is not considered in the sums acc. to Eqs.3,4,5). In buckling, the total slenderness is calculated acc. to equation:

$$\lambda_{\text{tot}} = \sqrt{\lambda_e^2 + \lambda_1^2}, \quad \lambda_e = L_1 / i_e, \quad i_e = \sqrt{I_e / A} \quad \dots/18$$

where  $L_1$  is for slenderness competent length, and  $\lambda_1$  the local slenderness of the most inconvenient part of the beam.

In torsion, the method can be used in the calculation of the composite box-cross-sections, acc. to Fig.7. Supposing the equal rotation-angle "u" of every single part and of the whole, we get:

$$u = T \cdot L / C_d, \quad C_d = \sum C_{di} + C_{da}, \quad C_{di} = G \cdot Y_i, \quad C_{da} = G_a \cdot Y_a \quad \dots/19$$

where T is the moment of torsion, L is the length, where the angle "u" is measured,  $C_d$  is the torsional stiffness, G is the timber shear modulus,  $G_a$  is the reduced shear modulus,  $Y_i$  is the local tors. mom. of inertia,  $Y_a$  the associated tors. mom. of inertia:

$$G_a = G / (1 + 100 \cdot z_{nij} \cdot G \cdot D / N_{sij} \cdot n_{sij} \cdot U_{ij}), \quad Y_a \doteq 4(H-D)^2 \cdot (B-D)^2 \cdot D / \sum U_{ij} \quad \dots/20$$

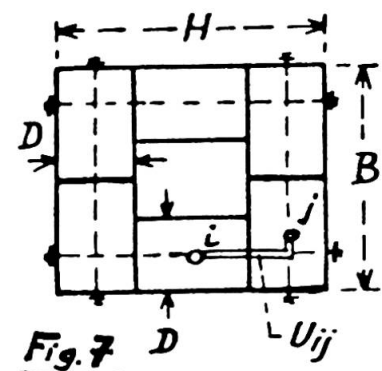
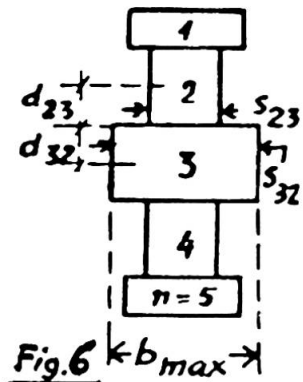
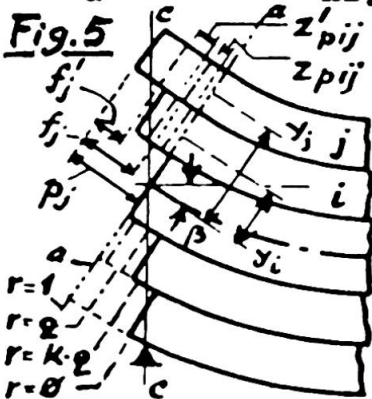



## II

**Synthese und Schlussfolgerungen**

Synthesis and Conclusions

Synthèse et conclusions

**E. GEHRI**

Dipl.-Ing.

Eidgenössische Technische Hochschule

Zürich, Schweiz

Auch im Holzbau vertraut heute der Ingenieur vermehrt den Zahlen und den Formeln. Eigenschaften und Verhalten von Baustoff und Bauteilen werden durch immer kompliziertere Ausdrücke umschrieben. Dabei stösst aber der Ingenieur immer wieder in Bereiche vor, in denen ungenügend gesicherte Aussagen vorliegen, wobei dies im Holzbau häufiger als bei den wesentlich jüngeren Baustoffen wie Stahl und Beton zutrifft.

Für eine erfolgreiche Ausführung von Holzbauten sind unerlässlich eingehende Kenntnisse über die technologischen Eigenschaften des Holzes und der Holzwerkstoffe, sowie über das Verhalten der Tragelemente und deren Verbindungen. Hinzu gehört aber auch ein tiefes Verständnis für die konstruktive Gestaltung und deren Bedeutung auf die Dauerhaftigkeit.

**BAUHOELZER**

Wissenschaftlich gesicherte Erkenntnisse über Bauhölzer beschränken sich vielfach auf Nadelholzarten, die in Nord- und Mitteleuropa sowie in Nordamerika geläufig vorkommen. Erst in neuerer Zeit wurden analoge Untersuchungen für Laubholzarten durchgeführt. Die Bevorzugung von Nadelholz als Bauholz ist durch reiche Vorkommen in den genannten Gebieten begründet. In Zonen mit gemischtem Vorkommen von Nadel- und Laubholz ist dies zum Teil durch die einfachere Bearbeitung des Nadelholzes bedingt.

Wir sollten uns heute von dieser Bevorzugung der Nadelholzarten lösen. Dies einerseits aus ökologischen Gründen, um in gemässigten Zonen die Mischwaldform zu fördern, aber andernseits um vorhandene technische Vorzüge des Laubholzes wirtschaftlich nutzbar zu machen. Schon heute kommen für gewisse Sonderausführungen wieder vermehrt Laubholzarten in Frage, weil sie eine grössere Dauerhaftigkeit und/oder einen höheren Brandwiderstand aufweisen. Ein Beispiel hierfür ist der Wiederaufbau der niedergebrannten früheren Munitionsfabrik in Hamburg-Altona [1]. Um den Anforderungen des Brandschutzes zu genügen, wurde Bongossi (*Lophira alata*), auch Azobé oder afrikanisches Eisenholz genannt, verwendet. Die Verwendung von Holzarten hoher natürlicher Dauerhaftigkeit z.B. für





Brückenbauten dürfte vor allem in Entwicklungsländern mit reichlichem Holzvorkommen zu wirtschaftlichen Lösungen führen. In gemässigten Zonen, wie z.B. in Mittel- und Osteuropa mit reichem Vorkommen an Buche sollte vor allem der zweckmässige Einsatz dieser Holzart gefördert werden. Dank der gegenüber Nadelholz höheren Leistungsfähigkeit der Buche, dürfte diese Holzart in Zukunft für grössere Tragwerke, die vor direkter Bewitterung geschützt sind, Verwendung finden. Versuche zeigen, dass mit den gleichen Querschnitten rund 30% höhere Kräfte als beim Nadelholz aufgenommen werden können.

## HOLZWERKSTOFFE

Der wichtigste für Tragwerke eingesetzte Holzwerkstoff ist das Brettschichtholz, ein Holzwerkstoff, der seit mehr als 70 Jahren verwendet wird. Kunstharzleime und leistungsfähige Anlagen, sowohl für die Keilzinkung der einzelnen Bretter zu endlosen Lamellen, als auch für die Trägerherstellung mittels Hochfrequenz-Durchlaufanlagen haben seither Einsatzbereich und Wirtschaftlichkeit des Brettschichtholzes wesentlich verbessert.

Trotz des grossen technologischen Fortschrittes sind hier noch nicht alle Fragen geklärt. Dies gilt auch für gekrümmte Träger und für Träger variabler Höhe.

GUTKOWSKI/DEWEY weisen auf die mögliche Versagensform von gekrümmten Trägern und von Satteldachträgern hin. Wegen der geringen Querkzugfestigkeit des Holzes - für Nadelholz beträgt die Querkzugfestigkeit nur rund 1/50 der Längszugfestigkeit - ist die genaue Erfassung der an sich geringen Querkzugspannungen von Bedeutung. Frühere Ansätze wurden nun mittels der Methode der finiten Elemente unter Verwendung orthotroper Elemente überprüft.

Die Versuchsträger verhielten sich praktisch bis zum Bruch noch elastisch. Die Berechnung zeigte denn auch eine gute Uebereinstimmung mit den Messergebnissen. Allerdings war keine genaue Bruchvorhersage möglich, weder über Art des Bruches noch über die Höhe der Bruchlast. Die Brüche ereigneten sich sowohl über Querkzug als auch über Biegung, hier eingeleitet durch Keilzinkenbrüche in den gezogenen Randlamellen. Infolge der grossen Streuung in den Festigkeitseigenschaften und dem Fehlen von geeigneten Bruchkriterien für kombinierte Beanspruchung bestehen Bedenken in der praktischen Anwendung allzu exakter Berechnungsverfahren.

Der genaueren Erfassung der Verformung dürfte sekundäre Bedeutung zukommen, da hier in der Regel eine "Sollvorschrift" vorliegt. Hinzu kommt, dass die elastisch ermittelte Verformung nur einen Anteil darstellt. Einen weiteren Anteil liefert noch die Kriechverformung, die normalerweise nur grob geschätzt wird.

YU/CHANG behandelten das Krafteinleitungsproblem in einer orthotropen Scheibe u.a. mit den Eigenschaften von Sperrholz. Die Ergebnisse zeigen die gegenüber isotropen Scheiben geringere Lastausbreitung. In der Regel kann bei Sperrholz und Beanspruchung zu einer der Hauptrichtungen nur mit einem Winkel der Lastausbreitung von rund  $15^\circ$  gerechnet werden. Dieses Ergebnis deckt sich mit der Auswertung von Zugversuchen an genagelten Sperrholzknotenplatten [2].

Die Behandlung von Krafteinleitungsproblemen in Sperrholzplatten darf nicht ohne Beachtung der Art der Einleitung erfolgen. Holz ist bei Zugbeanspruchung besonders kerbempfindlich. Wie Versuche an Buchensperrholz zeigten, spielen

sowohl Lochgrösse als auch die Verteilung eine wesentliche Rolle (siehe Abb. 1). Bei verteilter Anordnung kleiner Bohrungen stellt man eine gute Uebereinstimmung mit den theoretischen Werten, d.h. unter Beachtung des Lochabzuges, fest. Bei Einzelbohrungen stimmt dies jedoch nicht mehr. Der empirische Exponentialansatz zeigt eine gute Uebereinstimmung mit dem schraffierten Bereich der Versuche.



Abb. 1: Kerbwirkung in Abhängigkeit von Lochverteilung und Lochgrösse bei Sperrholz

## VERBUNDSTOFFE UND VERBUNDSYSTEME

Nebst den Holzwerkstoffen können auch Verbundstoffe und Verbundsysteme die Einsatzmöglichkeiten des Holzes erweitern. Eine derartige Möglichkeit besteht in der Vorspannung von Holzträgern durch hochwertige Stahldrähte. Obwohl die Zugfestigkeit von strukturstörungsfreiem Holz höher liegt als die Druckfestigkeit parallel zur Faser, wird bei den grossen verleimten Trägern das Versagen in der Regel durch einen Biegezugbruch eingeleitet.

Natürliche Strukturstörungen wie Aeste und Schrägfaserigkeit sowie Fertigungsprobleme mit Keilzinkungen der Lamellen sind hierfür verantwortlich. Durch Vorspannung oder auch nur durch eine Armierung mittels Stahl auf der Biegezugseite können diese Einflüsse begrenzt werden, sodass die Streuungen im Verbundsystem geringer sind und somit die Ausnutzung des Holzes höher liegt.

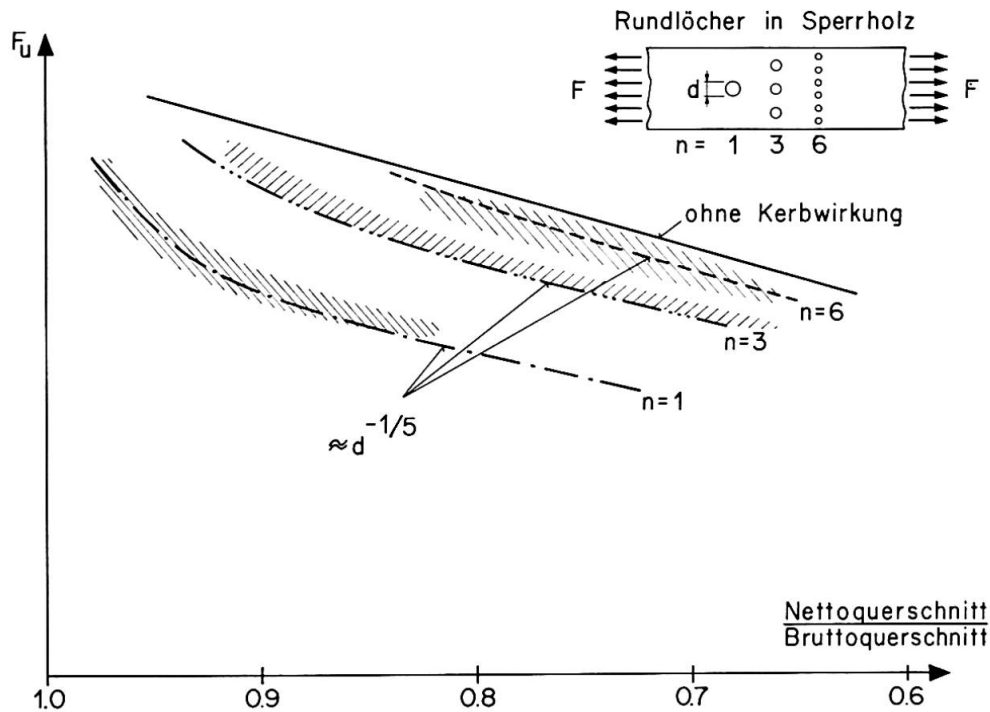
GILFILLAN/SIDWELL gehen noch einen Schritt weiter. Sie entwickeln ein Vorspannsystem bei dem sowohl eine Druck- als auch eine Zugvorspannung möglich ist. Dies wird ermöglicht durch die Entwicklung von in einem Hüllrohr geführten, auf Druck vorspannbaren hochfesten Stahldrähten. Die damit erzielten Erhöhungen der Tragfähigkeit sind bedeutend. Die Erfahrung mit ersten Anwendungen wird aufzeigen müssen, inwieweit Nutzen aus dieser interessanten technischen Lösung gezogen werden kann.

Verbundsysteme bestehend aus tragenden und isolierenden Schichten sind nicht



neu. Diese wurden vor allem für Fassaden, Dächer und z. Teil für Decken insbesondere in Kombination mit tragenden Stahlteilen entwickelt. Neu ist deren Anwendung in Verbindung mit Holz oder Holzwerkstoffe.

PREBENSEN/BUNCH-NIELSEN haben das Verhalten von Sandwich-Elementen mit isolierendem Kern aus Mineralwolle und Aussenschichten aus Sperrholz eingehend untersucht. Wegen des Kriechverhaltens der verwendeten Baustoffe darf man nicht allein auf Kurzzeitversuche abstützen. Je nach Aufbau und Zusammensetzung insbesondere der Kernschicht können infolge Feuchte- und Temperaturänderungen grosse Kriechverformungen auftreten. Bei den durchgeführten Untersuchungen mit konstantem Klima lag nach einem Jahr der Verformungszuwachs bei halbem Bruchlastniveau unter 20%. Dieser Wert ist gering. Versuche mit anderem Kernstoff wie Polystyrol-Hartschaum zeigen eine wesentlich stärkere Kriechneigung und eine starke Temperaturabhängigkeit.

Nebst Versuchen kommt der rechnerischen Erfassung bzw. der Aufstellung eines geeigneten Tragmodells grosse Bedeutung zu. Analog den Stahl-Beton-Verbundsystemen findet auch hier mit der Zeit eine Umlagerung statt, die berücksichtigt werden muss. Um die Grenzzustände zu erfassen, genügen hiefür die bekannten elastischen Modelle nicht mehr. Tragmodelle mit einer elastischen und einer plastischen Phase erlauben eine bessere Erfassung des Trag- und Verformungsverhaltens solcher Verbundsysteme.

## HOLZELEMENTE

Die geringen Abmessungen des Schnittholzes zwingen zur Herstellung verleimter Tragelemente oder zur Bildung zusammengesetzter Träger und Stützen.

MALHOTRA untersuchte eingehend das Tragverhalten zusammengesetzter Stützen. Ausgangspunkt seiner Betrachtungen bildet der ideale, zentrisch gedrückte Stab ohne Imperfektionen. Strukturstörungen, ungewollte Endexzentrizitäten, Stabausbiegungen, die zu einem Abfall an Tragvermögen führen, sind über einen geeigneten Sicherheitsfaktor in den Bemessungsformeln abzudecken. Diese Betrachtungsweise deckt sich nicht mit der heutigen Auffassung, Stabilitätsprobleme als Gleichgewichtszustände im verformten Zustand zu betrachten. Da bei zusammengesetzten Stützen jedoch der Einfluss der Verschieblichkeit der Verbindungen eine massgebende Rolle spielt und diese Grösse erheblichen Streuungen unterworfen ist, sind die Ergebnisse von MALHOTRA, die sich auf eine grosse Zahl von Versuchen abstützen, von grosser praktischer Bedeutung.

EDLUND zeigte die Möglichkeiten zur Nutzung von Tafелеlementen aus Holzwerkstoffen zur Stabilisierung der Tragkonstruktion auf. Bei entsprechender Ausbildung ergeben sich wesentlich einfachere und wirtschaftlichere Tragkonstruktionen. Der Ausbildung der Verbindung zwischen den scheibenförmigen Holzwerkstoffen und den Holzrahmen kommt dabei eine entscheidende Bedeutung zu.

VAN DER PUT untersuchte die Kräfteumverteilung in innerlich statisch unbestimmten Systemen an Hand eines Vierendeelrahmens. Infolge der unterschiedlichen Steifigkeit und Verformungsverhalten von geleimten und genagelten Knotenausbildungen können nicht mehr die gleichen Berechnungsmodelle benutzt werden. Die angegebenen Kriterien erlauben eine genauere Erfassung der Grenztragfähigkeit derartiger Systeme.

## VERBINDUNGSTECHNIK

Wie aus den meisten Referaten ersichtlich, kommt der Verbindungstechnik entscheidende Bedeutung zu. Nebst Tragfähigkeit spielt insbesondere bei zusammengesetzten Bauteilen auch das Verformungsverhalten eine grosse Rolle. Erwünscht sind insbesondere Verbindungen, die eine grosse Steifigkeit und hohes Tragvermögen und somit einen hohen Wirkungsgrad besitzen, zugleich aber auch noch eine grosse Duktilität d.h. vor dem Bruch ein hohes Verformungsvermögen aufweisen.

In Abb. 2 werden drei mögliche Verbindungsarten schematisch dargestellt. Diese weisen gleiche Tragfähigkeiten aber unterschiedliches Verformungsvermögen auf. Die Verbindungsart mit "weichen" Bolzen besitzt das beste Arbeitsvermögen.



Abb. 2: Verformungsvermögen von Verbindungen

BLUMER stellte in seinem Referat eine entsprechende Verbindung dar. Holzverbindungen bei denen Stahlbleche für die Knotenplatten eingesetzt wurden, sind seit über 50 Jahren bekannt [3]. Seither sind die verschiedensten Ausführungsformen aufgetaucht: nicht alle haben den Erwartungen entsprochen.

Eine Richtung tendierte auf den rationellen Einsatz von Nagelautomaten; dies bedingte die Verwendung dünner Bleche von weniger als 2 mm Stärke, die entweder nur aussen oder in Schlitze eingelegt werden. Andere beruhen auf Nagelplatten, die aussen in das Holz eingepresst werden.

Die Lösung von BLUMER repräsentiert eine dritte Gruppe, bei denen die Stifte oder Bolzen in vorgebohrte Löcher eingetrieben werden. Dadurch lassen sich dickere Knotenplatten und grössere Stiftdurchmesser verwenden. Diese Ausführungsart ist demnach besonders geeignet für grössere Tragwerke. Infolge des Vorbohrens wird die Rissgefahr stark reduziert. Die Abstände der Stifte untereinander können deshalb kleiner gehalten werden. Dadurch ergeben sich wesentlich kürzere Anschlüsse.

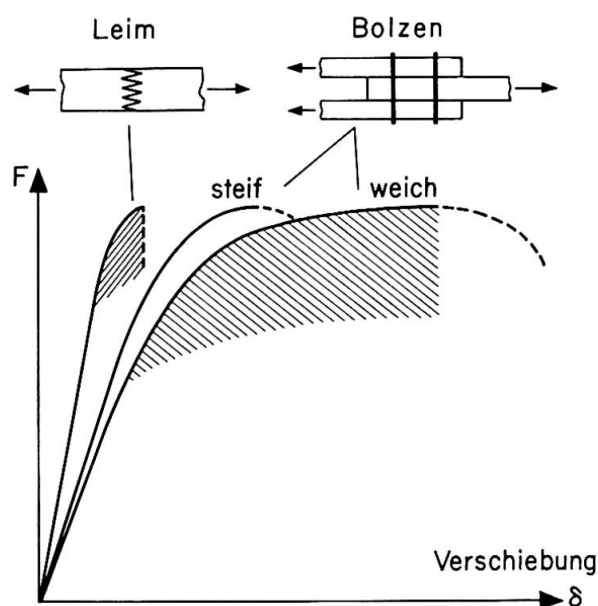
Extrem kurze Anschlüsse lassen sich - ohne Verminderung der Tragfähigkeit - durch lokales Absperren der Stabenden mittels dünner Furnierplatten erreichen (siehe hierzu Abb. 3).



Abb. 3: Stabanschlüsse mit geringer Anschlusslänge

Im Gegensatz zu den ersten zwei Gruppen bei denen sich die Anwendung auf Nadelhölzer beschränkt, sind derartige Verbindungen mit vorgebohrten Löchern für alle Holzarten, insbesondere für Laubholzarten einschliesslich der schweren tropischen Hölzer geeignet.

Eine Abwandlung - mit allerdings etwas geringerem Wirkungsgrad - besteht in der Ausbildung eisenfreier Knotenverbindungen, wie dies in korrosionsgefährdeten Bauten immer wieder angestrebt wird. An Stelle des Stahlbleches tritt ein hochwertiges Sperrholz (z.B. eine Furnierplatte aus Birken- oder Buchenholz) und an Stelle der Stahlstifte treten Holzstifte aus schweren tropischen Holzarten. Gegenüber einer gleichartigen Stahlverbindung weisen derartige Holznagelverbindungen einen um rund 1/3 geringeren Wirkungsgrad auf. Dies ist weitgehend durch die dickeren Schlitz für das Sperrholz und nur sekundär durch den etwas grösseren Durchmesser der Holzstifte bedingt.

## ANWENDUNGEN

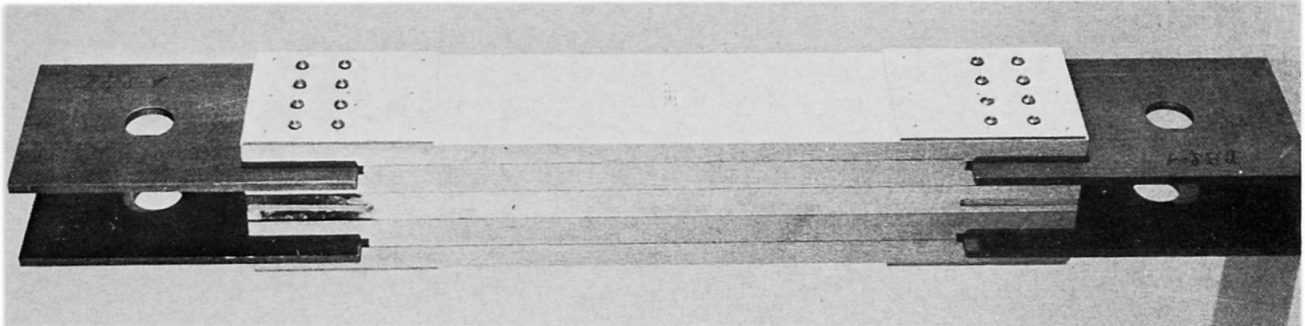
Die von den Referenten gezeigten Ausführungsbeispiele sind typisch für den heutigen Holzbau.

TURNER/WILSON zeigten, wie ein anspruchsvoller Ingenieurholzbau auch mit bescheidenen lokalen Mitteln durchführbar ist. Die Verarbeitung des Holzes ist - mit Ausnahme von Leimverbindungen - auch heute noch mit geringem maschinellen Aufwand möglich. Bei Anpassung des Entwurfes und der Ausführung an die lokalen Bedingungen, wie verfügbare Holzarten, Ausbildungsstand der Arbeitskräfte, maschinelle Einrichtungen, sind technisch anspruchsvolle und dennoch wirtschaftliche Lösungen möglich.

NATTERER weist mit seinem Beitrag auf die Leistungsfähigkeit des Holzes hin, grosse Spannweiten wirtschaftlicher zu überspannen. Erst das Brettschichtholz ermöglichte die grosse Entwurfsfreiheit sowohl in Form als auch in Spannweite. Die Möglichkeiten in diesem Bereich sind noch nicht ausgeschöpft. Besonders in Verbindung mit aggressiven Medien, wie bei der Salzgewinnung, in Kohlenmischanlagen, aber auch bei Müllverwertungs- und Kompostierungsanlagen, hat sich das Holz als besonders widerstandsfähig gezeigt. Eine vermehrte Verwendung von Holz in diesen Bereichen ist deshalb zu erwarten.

MAHIEU geht auf die Ausführung einer Fussgängerbrücke mit der grossen Brücken-



breite von 5 m ein. Infolge der beschränkten Herstellungsmöglichkeit bezüglich Trägerhöhe wurde jeder Hauptträger aus je 3 nebeneinanderliegenden Trägern gebildet, wodurch sich eher ungewöhnliche Anschlussprobleme ergaben. Wie bei allen frei der Witterung ausgesetzten Holzbauwerken sind auch hier konstruktive Detailausbildung und komplementärer Holzschutz von entscheidender Bedeutung für die Lebensdauer solcher Tragwerke.

GUTKOWSKI/WILLIAMSON geben einen ausgezeichneten Ueberblick über den Holzbrückenbau in den USA. Die heutigen Tendenzen gehen in Richtung eines vermehrten Einsatzes von Brettschichtholz und eines wirkungsvolleren Holzschutzes mittels Druckimprägnierung. Eine neuere Entwicklung besteht in der Anwendung von Furnierschichtholz (Press-Lam). Durch die Verwendung von Furnieren erreicht man eine Homogenisierung der Holzeigenschaften. Zudem zeigte sich, dass sowohl Imprägnierbarkeit als auch Dauerwirkung der Imprägnierung verbessert werden.

Die von GUTKOWSKI/WILLIAMSON skizzierten Entwicklungen sind interessant, da sie zu einer Verminderung des Holzverbrauches bei gleichzeitig höherer Dauerhaftigkeit der Brückenbauten führen. Die rechnerische Erfassung des Tragverhaltens der Fahrbahnsysteme ist infolge des unvollständigen Zusammenwirkens nur bei gleichzeitiger experimenteller Untersuchung möglich. Wichtig ist zudem - wie GUTKOWSKI/WILLIAMSON aufzeigten - die praktische Erprobung derartiger Brückensysteme durch den Bau von Prototypen. Erst durch eine Kombination von Berechnung, experimenteller Untersuchung und praktischer Erprobung kann in der Holzbauweise eine gesicherte Entwicklung gewährleistet werden.

CSAGOLY/TAYLOR befassten sich eingehend mit der konstruktiven Verbesserung der in Nordamerika üblichen Ausführung der Fahrbahn mit längslaufenden hochgestellten Bohlen. Während in den USA die Tendenz besteht diesen genagelten Bohlenbelag, der bei stärkerer Beanspruchung frühzeitige Schäden aufweist, durch verleimte plattenartige Elemente zu ersetzen, zeigten CSAGOLY/TAYLOR eine einfache und bestechende Lösung, um die Tragfähigkeit und Dauerhaftigkeit derartiger Bohlenbeläge wesentlich zu verbessern. Durch die Quervorspannung der längs angeordneten Bohlen, werden die gegenseitigen Bewegungen eliminiert und eine der Verleimung ähnliche Plattenwirkung erzielt. Das ganze System ist übersichtlich und unempfindlich. Vorspannelemente lassen sich auch nachträglich als Sanierungsmassnahme anbringen.

Gerade dieses Beispiel zeigt, wie der moderne Ingenieurholzbau von den in anderen Bauweisen erprobten Techniken zu profitieren weiss und wie eine über die betreffende Bauweise hinausgehende Betrachtungsweise befruchtend wirkt.

## NORMUNG

SUNLEY hat im Einführungsbericht eingehend über die internationalen und europäischen Normierungsbestrebungen im Bereich des Holzbaues berichtet. Neuere Normentwürfe sind seither erschienen. Sichtbar sind die Bestrebungen die verschiedenen Bauweisen gleichartig zu behandeln. Dennoch wird eine Holzbaunorm inhaltlich anders aussehen müssen als eine Stahlbaunorm oder eine Norm über Betonbau.

Die wichtigsten Unterschiede resultieren direkt aus den mechanischen Eigenschaften des Holzes, Eigenschaften die infolge der ausgeprägten Anisotropie zu dem stark von der Kraft- zur Faserrichtung abhängig sind.





Für die Bemessung von Holzbauten ist die Kenntnis der Einwirkungsdauer der Lasten von Bedeutung. Die heutigen Bestrebungen gehen dahin 5 verschiedene Lastdauerklassen zu unterscheiden. Die einzelnen Lastarten sind jeweils einer solchen Lastdauerklasse zuzuordnen bzw. in gewissen Fällen auch zwei solcher Klassen. So wird in der Regel der Schnee als mittelfristige oder als kurzfristige Last betrachtet, je nachdem ob ein häufiger Wert oder ob ein Extremwert betrachtet wird.

Zu beachten ist auch die jeweilige Feuchte des Holzes, beeinflusst doch die Holzfeuchte entscheidend den Tragwiderstand und die Steifigkeit des Holzes. Holzfeuchteänderungen führen zudem zu grösseren irreversiblen Verformungen.

Versuche zur Ermittlung des Tragwiderstandes von Bauteilen zeigen einen eindeutigen Grösseneinfluss auf. Diese auch Volumeneinfluss genannte Erscheinung ist besonders ausgeprägt bei Baustoffen mit sprödem Bruchverhalten. Beim Holz ergeben sich grosse Bereiche mit hoher Zugbeanspruchung vor allem bei Biegeträgern. Dies führt dazu, dass bei Holzbiegeträgern ein sogenannter Höhenfaktor zu beachten ist.

Wie bei den anderen Bauweisen muss sich der entwerfende Ingenieur von Anfang an mit dem Baustoff und dessen Verarbeitung auseinandersetzen und erst anschließend kann er sich der eigentlichen Berechnung und Bemessung widmen. Eine klar gefasste vereinheitlichte Normierung kann und wird ihm helfen, diese Aufgabe mit der geforderten Sicherheit zu lösen.

#### LITERATURVERZEICHNIS

- [1] WEBER, M.: Wiederaufbau der "Fabrik" in Hamburg-Altona. Bauen mit Holz, 1980, S. 53-55.
- [2] DRÖGE, G.: Tragende Holzwerke aus Vollhölzern mit genagelten Knotenplatten aus Sperrholz. Bauen mit Holz, 1966, S. 357-362.
- [3] Ingenieurholzbau - Entwurf und Bemessung von Schnittholz-Konstruktionen mit neuzeitlichen Verbindungen. Schweizerische Arbeitsgemeinschaft für Holzforschung, 1979.