

Zeitschrift: IABSE congress report = Rapport du congrès AIPC = IVBH
Kongressbericht

Band: 12 (1984)

Artikel: Burlington Northern Railway overpass, Burnaby, BC

Autor: Longstaff, John / Rushforth, Andrew

DOI: <https://doi.org/10.5169/seals-12199>

Nutzungsbedingungen

Die ETH-Bibliothek ist die Anbieterin der digitalisierten Zeitschriften. Sie besitzt keine Urheberrechte an den Zeitschriften und ist nicht verantwortlich für deren Inhalte. Die Rechte liegen in der Regel bei den Herausgebern beziehungsweise den externen Rechteinhabern. [Siehe Rechtliche Hinweise.](#)

Conditions d'utilisation

L'ETH Library est le fournisseur des revues numérisées. Elle ne détient aucun droit d'auteur sur les revues et n'est pas responsable de leur contenu. En règle générale, les droits sont détenus par les éditeurs ou les détenteurs de droits externes. [Voir Informations légales.](#)

Terms of use

The ETH Library is the provider of the digitised journals. It does not own any copyrights to the journals and is not responsible for their content. The rights usually lie with the publishers or the external rights holders. [See Legal notice.](#)

Download PDF: 15.03.2025

ETH-Bibliothek Zürich, E-Periodica, <https://www.e-periodica.ch>

Burlington Northern Railway Overpass, Burnaby, BC

Viaduc du Burlington Northern Railway, Burnaby, BC

Die Überführung der Burlington Northern Railway in Burnaby, BC

John LONGSTAFF
Res. Eng.
AESL
Vancouver, B.C., Canada

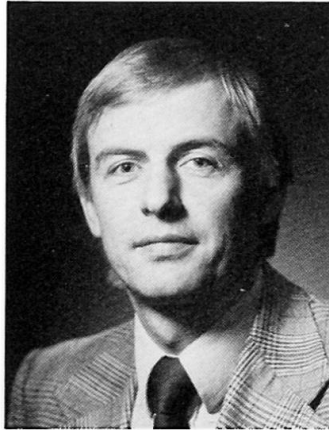

John Longstaff, born in 1950, obtained his civil engineering degree at the University of Bristol, England. J. Longstaff has since worked on the design and construction of a variety of concrete and steel bridges in England, Hong Kong and now Canada, where he is presently supervising completion of the subject structure.

Andrew RUSHFORTH
Chief Struct. Eng.
Graeme & Murray Consult.
Vancouver, B.C., Canada

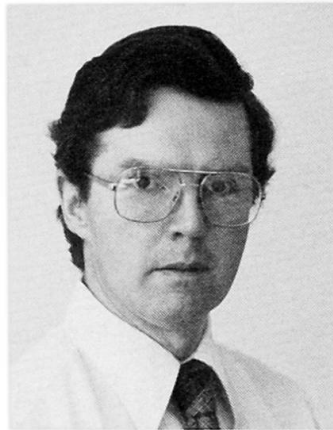

Andrew Rushforth, born in 1940, obtained his civil engineering diploma at Loughborough University of Technology, England. A. Rushforth has been involved in the design and construction of bridges, buildings, atomic power station structures and other projects in the U.K. and Canada for 21 years.

SUMMARY

This structure is an unusually curved structure built in an area of peat and soft silt deposits up to 20 metres deep. It features the use of continuous curved steel box girders, specially designed rubber pot bearings and steel pipe piles. This paper describes some of the unusual difficulties and the solutions adopted in pile and pile cap construction and girder fabrication and erection.

RESUME

Cette structure, de courbure très prononcée, est construite dans une zone de tourbe et de dépôts limoneux meubles d'une profondeur atteignant 20 mètres. Elle est caractérisée par l'emploi de poutres à caisson métalliques continues et courbes, d'appuis spécialement conçus et de pieux métalliques circulaires remplis de béton. L'article décrit certaines des difficultés exceptionnelles rencontrées et les solutions adoptées dans la construction de pieux et de têtes de pieux et dans la fabrication et le montage des poutres.

ZUSAMMENFASSUNG

Das Bauwerk ist eine aussergewöhnliche, gekrümmte Brücke. Sie steht in einem Moorgebiet, dessen Bodenschicht bis zu einer Tiefe von 20 Metern aus Torf, Schluff und Feinsand besteht. Die Konstruktion verwendet gekrümmte Stahlkastenträger, speziell entworfene Gummitopflager und Stahlrohrpfähle. Dieser Bericht beschreibt einige der Schwierigkeiten und die angewandten Lösungen für die Pfahl- und Pfahlrostausführung, sowie der Trägeranfertigung und deren Montage.

1. INTRODUCTION

This overpass carries a four lane urban link road with approach ramps eliminating a heavily-trafficked at-grade railway crossing. Property restrictions and the need to distribute traffic onto local roads to reduce the impact on nearby residential areas dictated the complex horizontal and vertical geometry.

The geometrical alignment features a main structure on a transition to 160 m radius, 250 m long and up to 30 m wide, and two approach ramps varying from straight to 80 m radius each approximately 240 m long by 6 m wide.

The superstructure comprises single and multiple continuous rectangular steel box girders up to 1.8 m deep with spans between 28.0 and 51.0 m, and a cast-in-place reinforced concrete deck slab utilizing ribbed metal decking for permanent formwork.

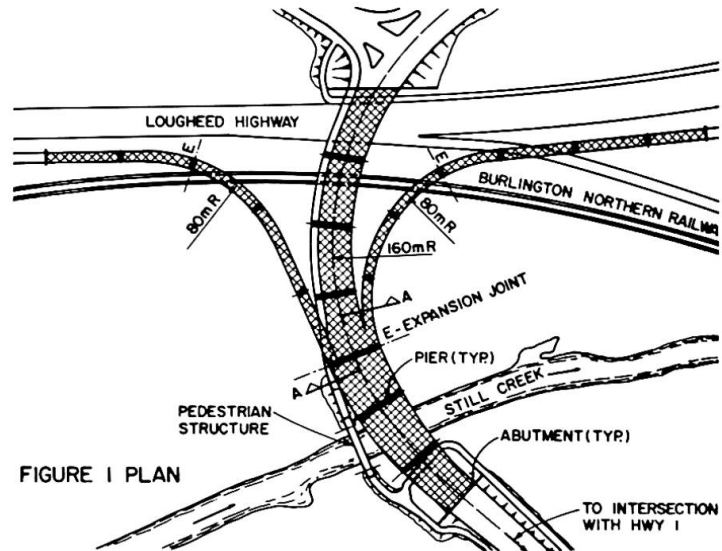

FIGURE 1 PLAN

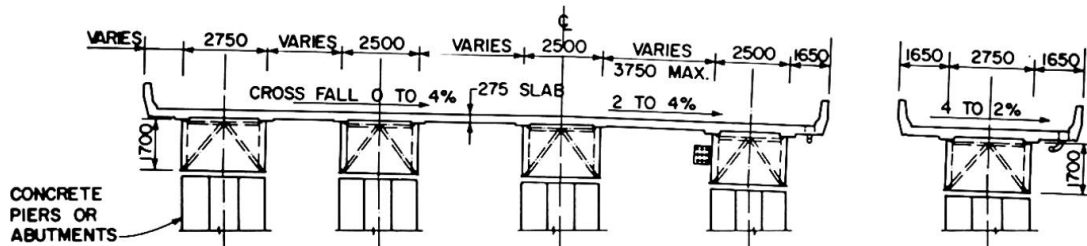

FIGURE 2 SECTION A-A

The foundations feature the use of concrete-filled steel pipe piles to resist the high moments and forces which may be induced due to seismic loading. No lateral support is provided by the peat and silt layers over most of the length of the piles. A working slab was provided, supported off the piles to support the cast in-situ concrete pile cap.

This paper describes the construction techniques adopted and the method of calculating the variable girder plate geometry.

2. SUBSTRUCTURE CONSTRUCTION DETAILS

2.1 Piling

Ground conditions comprise a layer of peat up to 10 m deep overlying 2 m to 10 m of soft silt and 2 m to 5 m of glacial till, with sandstone bedrock below. The layers of peat and soft silt provide no horizontal restraint and in fact may induce high horizontal loads on the piles under seismic conditions. Concrete-filled steel pipe piles were selected for their greater flexibility in resisting high bending moments induced in each pile. A combination of closed-end pipe piles, battered at 1:3 or 1:4, driven to end bearing in the glacial till, and vertical drilled-in pipe piles socketed into the till and sandstone was chosen. Pipe diameter varies from 406 mm to 762 mm and wall thickness from 9.53 mm to 15.88 mm, including an allowance for corrosion on the outside of the piles.

Stability of the piling rig in the soft ground conditions was a major concern, particularly for the larger diameter pipe, which, coupled with the heavy diesel hammer and the rake of the leads, produced a high overturning moment. Large timber pads measuring 6-m x 3-m in up to two layers were placed upon a layer of hog fuel (wood waste product) for rig support and movement. The larger diameter piles were driven only along the axis of the rig, (forwards or backwards), although the 406 mm and 508 mm diameter piles could also be driven with the leads battered to the side at some locations. Piles were handled in maximum 14.0 m lengths and spliced together in the piling leads by a butt-welded connection where necessary.

No driving of the piles was generally required through the peat layer since these penetrated under their own weight and had to be supported during splicing to prevent them from sinking. However, for the larger 762 mm diameter piles, a considerable positive buoyancy occurred at depths over 20 m and the diesel hammer weight was only just sufficient to push them into the top of the silt layer. Driving thereafter achieved a satisfactory embedment into the silt and glacial till, which easily overcame the uplift forces. A number of piles were checked, after driving and before concrete placement, for signs of uplift including a second pile set, but none was evident. Had these piles been much larger, they would probably have had to be driven either part filled with water or a dry concrete plug to overcome the buoyancy.

The control of pile location and batter was often a problem in the soft ground, particularly where underground obstructions such as boulders were encountered. In some instances, it was possible to extract and re-drive the piles, but often it was preferable to allow a pile drift out of position rather than hold it rigidly at the surface and risk bowing or buckling of the pile. At two locations where this did occur, new piles had to be driven.

The use of pipe piles, later filled with concrete, proved to be an entirely satisfactory solution in these ground conditions, both from a handling point of view and also for inspecting pile shaft alignment after driving. Any bow or buckle in the pile would have considerably reduced the capacity of the pile.

2.2 Pile Cap Support

The peat was unable to support the weight of wet concrete in the pile cap (1.5 m thick) so that a temporary method of support for this structure was devised. A horizontal construction joint within the pile cap utilizing the bottom layer of reinforcement was ruled out because of the amount of additional shear reinforcement that would be necessary to provide a full strength composite connection. The contractor adopted a separate R.C. working slab 150 mm to 300 mm thick supported on the permanent piles immediately below the pile cap. Additional brackets were welded on the outside of the piles to improve the punching shear strength. Horizontal connection of the piles was achieved within the working slab, and pile fixity into the pile cap by means of straps welded to the outside of the piles. To support the working slab during construction and concrete placement, the excavation was covered with a filter cloth, overlain by up to 200 mm thickness of granular bedding. This provided a firm and dry base for the light loads placed on it.

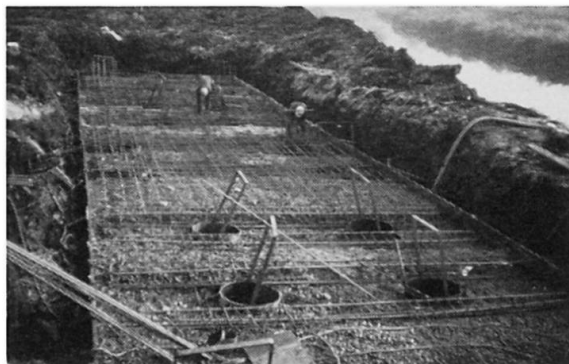

Figure 3. Pile cap working slab.



2.3 Bearings

Specially-designed rubber-pot bearings were used to cater for the large horizontal forces and movements anticipated under seismic conditions. Bearings were also designed with limit stops, to control longitudinal movement and distribute seismic loads over a number of piers, under these conditions. Bearings were arranged in pairs at column tops below each girder. Bearing tolerances for location, elevation, and rotation were tight and presented a major problem given the geometry of the structure and the fact that almost every location was unique. The guided bearings were particularly difficult and had to be set to ensure that the guides were parallel to ± 0.5 mm. A fine pitch screw adjuster welded between both bearing top plates was used to achieve this.

Separate taper-plates were used to account for the varying grade, superelevation and bearing orientation. These had a recess fit over the bearing top plates and were later welded through slots in the girder bottom-flange for attachment to the superstructure. Bearing bottom-plates were attached to columns by bolted dowel connections. All bearings incorporated features to facilitate their replaceability.

3. SUPERSTRUCTURE GEOMETRY

The vertical and plan geometry of the finished deck is governed by a control line which in plan has compound curves, transition spirals and tangents, and vertically combines straight grades, crest and sag curves. Superelevation of the deck varies over the length of the structure. In the multiple box sections, the box lines follow an independent plan geometry of compound curves.

The steelwork had to be fabricated cambered, to compensate for the dead-load deflection and to take account of the torsional deformation from concrete placement. Custom-made computer programs were developed for calculating the true shape of plates using coordinate geometry. The x, y, z coordinates were directly related to the site grid.

3.1 Web-Plate Geometry

Material handling and shipping limitations dictated additional welded splices in web and flange material. Typical web-plate lengths were in the 10-m range.

The following procedure was adopted for the calculation of the true shape of the individual web plates:

3.1.1 The plan (x, y) coordinates for the bottom edge of each web plate were calculated at 1000-mm increments (in plan) with the remainder, to end of plate, being an odd dimension.

3.1.2 The corresponding control line station (x_C, y_C) and offset (x_C, y_C to x, y) were then calculated.

3.1.3 The bottom web elevation (z) for each point x, y was calculated combining the vertical alignment elevation of x_C, y_C , superelevation change across the deck, adjustment for concrete-slab and web depth, dead-load box deflection, and torsional displacement.

3.1.4 The true slope length along the web bottom was found by summation of the distances (ds) between the series of web x, y, z coordinates.

3.1.5 The horizontal and vertical offsets, for each point, from a chord between ends of web x_1, y_1, z_1 and x_n, y_n, z_n , were found as shown in Fig. 4, and hence the true geometry of the web bottom is known with:

dv = vertical chord offset
 dc = increments of 1000 (in theory this dimension in space is greater than 1000 but the error in (dv) is negligible. The cumulative error over a web plate is rolled into the end (dc) remainder. Summing all (dc) increments gives the true chord length in the plane of the web.

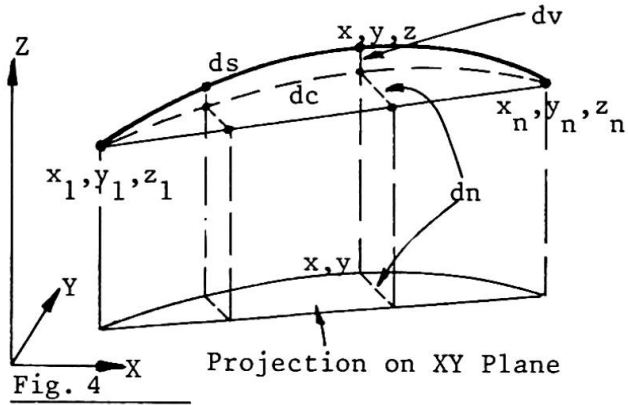

3.1.6 This data was then applied to find the shape of a flat web plate which when curved and positioned in space approximated closely to the theoretical noncylindrical surface of the true web in the following manner.

3.1.7 The orientation of the cambered box cross section in space (α° to the horizontal) is already known at the x,y,z web points from earlier data of deck superelevation and box torsional deformation.

The vertical offset (dv) required adjustment for the plate rotation of (α°) about the chord axis between the web end points. (Fig. 5)

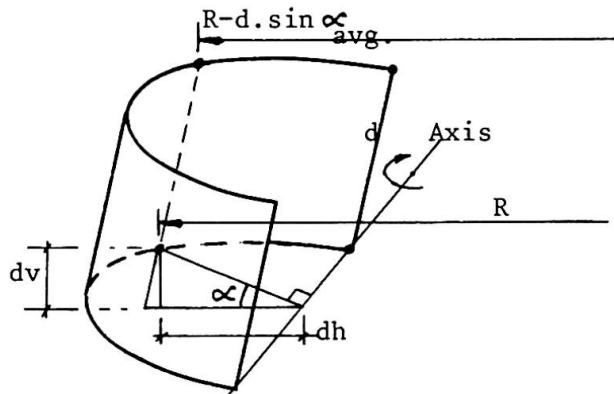

For Plate cutting dv becomes $\frac{dv - dh \cdot \tan \alpha}{\cos \alpha}$

In general, the top edge of web was a constant distance (d) from the bottom profile although in one of the on-ramp structures, the depth varied and this required an additional adjustment to (dv).

3.1.8 All web splices (bolted and welded) were normal to the bottom of web profile. For end cut accuracy, the plate diagonals were calculated with respect to the two bottom corners.

From the basic x,y,z information, the angle (β) between the local tangent at web end and the bottom chord was found and therefore, theoretical points D and C for the top corners were found with respect to the bottom corners A and B.

To compensate for the web top being proportionally shorter than the bottom of web due to the super-elevation, D' and C' were adjusted further by:

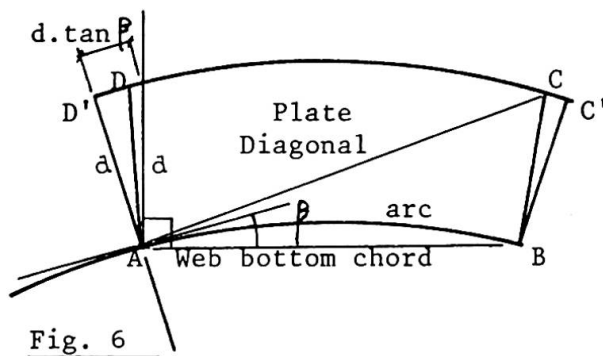

$$\frac{0.5 (\text{bottom arc length}) (d) \sin \alpha_{\text{avg}}}{R}$$

R

The plate shape ABCD was therefore known in a two-dimensional coordinate system and diagonals, end cuts, etc. could all be calculated. This data was used in a custom-written CAD program to produce plate-cutting sheets.

3.1.9 For splicing individual web plates together, the theoretical relationship of the two plates is needed for layout purposes. The simple butting of two cut plates together being too sensitive to cutting inaccuracies.

The long chord and offset data were calculated from the information found in the preceding section by solving the geometry of two abutting triangles.

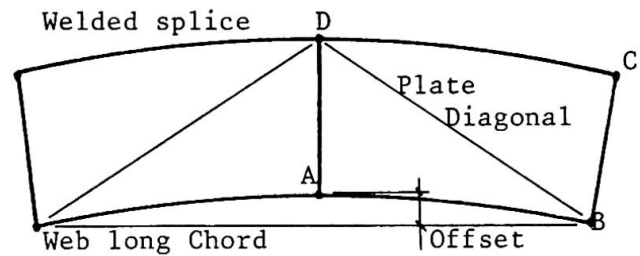

Fig. 7

3.2 Flange Geometry

The shapes of the bottom flanges were determined by calculating a series of coordinates defining both inner and outer arcs in a similar manner to that used for the webs.

The straight line chord lengths and the chord following the vertical alignment were calculated. The local end coordinates of the corners were then adjusted by this chord difference to give the geometry of a flat plate which, when curved in space, corresponds to the true flange shape, (Fig. 8), the cutting radius being that of a curve with the same chord offset as the plan geometry but with the longer chord.

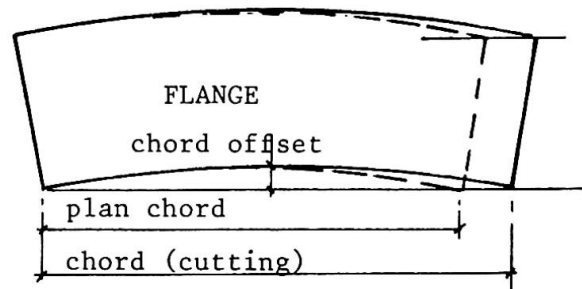

Fig. 8

Top flange shapes were computed by hand using for the flange centre-line length the data generated for top-of-web. An approximate cutting radius was used based on that of the box centreline but adjusted similarly to the bottom flange. The maximum chord offset error from this approximation was 5 mm, but permitted both left and right flanges to be fully nested and cut with one pass of the plate-burning machine.

4. SUPERSTRUCTURE CONSTRUCTION DETAILS

4.1. Shop Assembly

The size of the available shop area and crane capacity were relatively small in relation to the size of boxes. The use of both assembly jigs and rolling frames was considered essential to permit high rates of productivity and allow for simultaneous welding of both webs to flange to reduce distortion. Optimum assembly time for the seventy-one boxes fabricated varied with box size from three to five days. The typical arrangement of an assembly jib (Fig. 9) was designed to accommodate boxes of different sizes. Top flanges were 500 mm, 525 mm or 625 mm wide, bottom flanges 2550 mm or 2800 mm and webs from 1250 mm to 1760 mm. Initial assembly of the main material took place with the curved box orientated on its side.

For each box, three to six jigs were used, spaced at up to 5 m centres, depending on box length. Jig centres were standardized with setting distances H and V being calculated from the basic x, y, z , information.

The ordinate V at each jig follows the curve of the box with the mean position being at the height of the rolling frame axis. The top flange and webs rested on a subframe which could be adjusted vertically by means of a screw. The bottom flange support was similarly adjustable except the whole arm pivoted about the base with a lift pivot at the top end. The shop cranes were thus able to lift plates weighing 150% of available capacity.

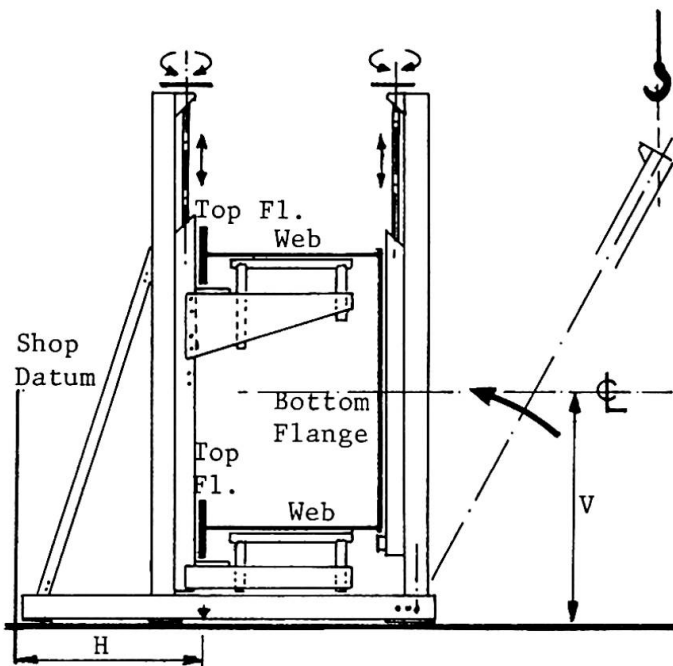

Fig. 9 Assembly Jigs

Two rolling frames (Fig. 10) were located at approximately the one-fifth point from each end and secured around the box after passage of the automatic welding machines. The boxes were then rotated through 180° for completion of the web-to-flange welds and rotated to intermediate positions for optimum welding of internal stiffeners, gussets, cross-bracing, etc.

The variable superelevation and torsional deformation resulted in boxes needing a rotational change over their lengths. These 'twists' were set with the box in the rolling frame, bottom flange down, by adjusting one frame with respect to the other until the calculated 'twist' was achieved. Installation of the horizontal diagonal-bracing locked this twist into the box.

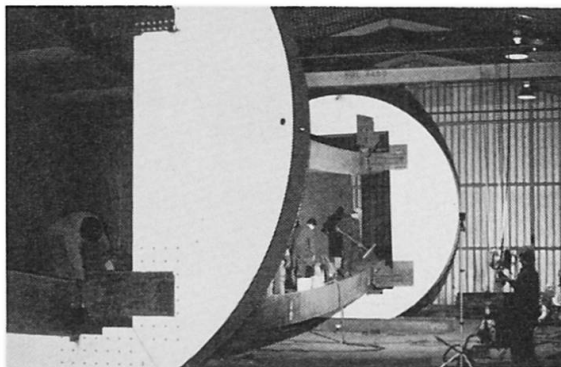

Figure 10. Rolling Frames.

4.2 Girder Erection

Each girder line was made up from boxes spliced by bolted connections at span quarter-points. Boxes were fabricated separately, trial assembled to adjacent boxes for reaming of splice holes and transported to site. On site, girders were spliced together in pairs and lifted into position. Most lifts were achieved using a single 125-t or 200-t capacity crane, although for spans below overhead transmission lines or over railway tracks, a second, smaller crane was used.

Individual girder lifts varied from 30 t to 100 t. Support pads made up of heavy timber placed above the hog fuel, similar to those required for the piling operation, were used for crane and equipment support and movement. Ground settlement did occur during most lifting operations and great care had to be taken to limit this as much as possible. Frequently, girders were assembled close to their final alignment and position so that they could be lifted into position by a short swing or by 'booming in'.

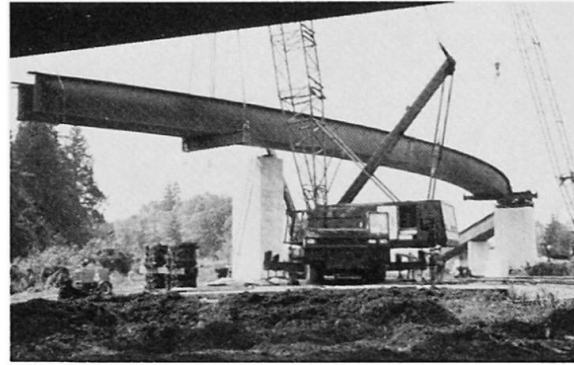

Figure 11. Girder erection.

4.3 Deck Construction

The deck comprises a 275-mm thick concrete slab with a nominal 75-mm concrete haunch. The concrete haunch was adjusted to suit the small variations in girder profile. Temporary formwork support beams were accurately levelled from the girders after a detailed survey, and all soffit, reinforcement, and deck screeding levels automatically followed from control of these beams.

To avoid stripping of formwork between and within girders, permanent formwork in the form of galvanized ribbed metal decking was used. Ribs were placed parallel to girders, with a flashing to cover the variable gap between the straight decking sections and the curved top flange. This proved to be a satisfactory alternative to removable formwork. The additional concrete in the ribs was, however, nonstructural and resulted in a 5% increase in the volume of deck concrete.

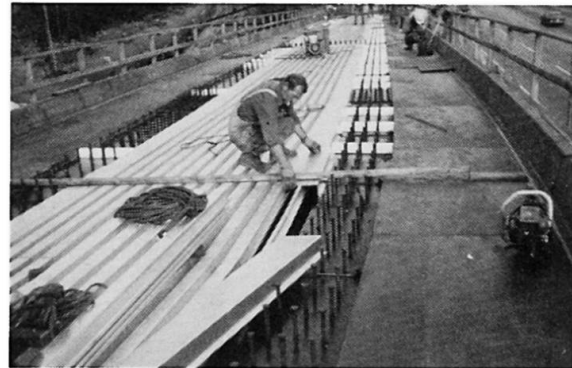

Figure 12. Metal decking.

Transverse construction joints were used to permit a sequential concreting operation and limit cracking due to girder flexure.

Site-batched superplasticizer was added to the deck concrete to ensure satisfactory and uniform workability whilst maintaining a low water/cement ratio of 0.4. This assisted in reducing shrinkage cracking in the continuous-deck sections, which are up to 150 m long. Cracks that did occur were sealed by epoxy pressure injection.

Epoxy coating of the top layer of deck reinforcement was used to provide corrosion resistance. Silane concrete sealant was applied to the top surface of the deck to reduce salt penetration.

5. ACKNOWLEDGEMENTS

The authors would like to thank the Corporation of the District of Burnaby for permission to publish this article, and the many contractors involved on this project for their ideas and construction methods which provided much of the basis for this article.