

Eccentrically loaded concrete columns: 15 years of sustained load

Autor(en): **Green, R. / Breen, John E.**

Objektyp: **Article**

Zeitschrift: **IABSE congress report = Rapport du congrès AIPC = IVBH
Kongressbericht**

Band (Jahr): **12 (1984)**

PDF erstellt am: **21.07.2024**

Persistenter Link: <https://doi.org/10.5169/seals-12215>

Nutzungsbedingungen

Die ETH-Bibliothek ist Anbieterin der digitalisierten Zeitschriften. Sie besitzt keine Urheberrechte an den Inhalten der Zeitschriften. Die Rechte liegen in der Regel bei den Herausgebern.

Die auf der Plattform e-periodica veröffentlichten Dokumente stehen für nicht-kommerzielle Zwecke in Lehre und Forschung sowie für die private Nutzung frei zur Verfügung. Einzelne Dateien oder Ausdrucke aus diesem Angebot können zusammen mit diesen Nutzungsbedingungen und den korrekten Herkunftsbezeichnungen weitergegeben werden.

Das Veröffentlichen von Bildern in Print- und Online-Publikationen ist nur mit vorheriger Genehmigung der Rechteinhaber erlaubt. Die systematische Speicherung von Teilen des elektronischen Angebots auf anderen Servern bedarf ebenfalls des schriftlichen Einverständnisses der Rechteinhaber.

Haftungsausschluss

Alle Angaben erfolgen ohne Gewähr für Vollständigkeit oder Richtigkeit. Es wird keine Haftung übernommen für Schäden durch die Verwendung von Informationen aus diesem Online-Angebot oder durch das Fehlen von Informationen. Dies gilt auch für Inhalte Dritter, die über dieses Angebot zugänglich sind.

Eccentrically Loaded Concrete Columns; 15 Years of Sustained Load

Poteaux de béton sous charges excentriques; 15 années de charge soutenue

Exzentrisch belastete Stützen; 15 Jahre Dauerbelastung

R. GREEN

Prof.
Univ. of Waterloo
Waterloo, ON, Canada

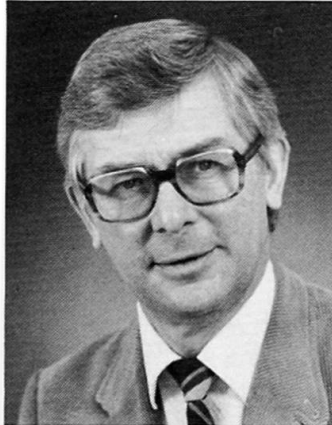

Author of papers on columns, bridge vibration and steel construction. Member of the Code Development Committee of OHBDC and Committee CSA A23.3.

John E. BREEN

Prof.
Univ. of Texas
Austin, TX, USA

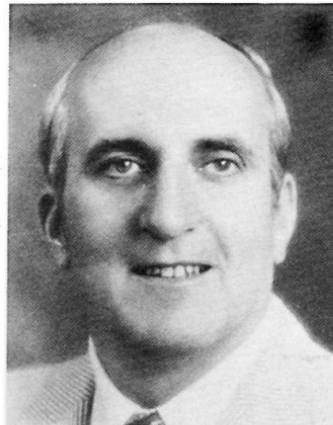

Director of the Phil M. Ferguson Structural Eng. Lab. at Austin. Author of papers on reinforced and prestressed concrete research and development. A former Chairman of ACI TAC and the new Chairman of Committee ACI 318.

SUMMARY

The sustained load response of ten unrestrained eccentrically loaded columns is described for an observation period of 15 years. Results of observations are compared with values given by the ACI 318-83 code. Analyses incorporating the time dependent characteristics of concrete permitted the prediction of failure times, deflections, and capacities to acceptable accuracies.

RESUME

Le comportement de poteaux non-encastés, soumis à des charges continues et excentriques pour une période de 15 ans, est décrit. Les valeurs mesurées sont comparées à celles de la norme ACI 318-83. Des analyses incorporant les caractéristiques du béton en fonction du temps permettent de prédire les temps de rupture, les déformations et les résistances selon les limites permises.

ZUSAMMENFASSUNG

Das Verhalten von zehn seitlich ungehaltenen, exzentrisch belasteten Stützen unter Dauerlast wird beschrieben. Die Beobachtungsperiode betrug 15 Jahre. Die Versuchsergebnisse werden mit den Werten der Norm ACI 318-83 verglichen. Eine analytische Berechnungsmethode, die die zeitabhängigen Charakteristiken des Beton berücksichtigt, erlaubt die Bestimmung der Standzeit bis zum Bruch, der Verformungen wie auch des erforderlichen Widerstandes für eine bestimmte Standzeit und Last.

1. INTRODUCTION

The analysis of reinforced concrete columns under sustained load can be difficult and time consuming. Data describing the effects of various sources of material nonlinearity must be combined with member geometric nonlinearity if the load-deformation-time response of slender compression members is to be predicted.

In the mid 1960's, when these studies of eccentrically loaded slender columns under sustained load began [1] most previous studies had been concerned with the sustained load behavior of axially loaded columns or with the maximum sustained load capacity of short eccentrically loaded columns. Some results pertaining to sustained load responses of slender columns ($\lambda \approx 100$) were also available [2]. The studies of the 1960's were intended to provide a more general approach covering not only the overall response of a column to sustained load, but also the load-moment-curvature-time sectional behavior. Based on this behavior, it was expected that the time-dependent-stress-strain model would allow the prediction of sectional response, and member response.

In this paper, tests over a duration of 15 years on a series of ten unrestrained eccentrically loaded columns are described. The results include columns which crept to rupture and others which were still stable following nearly 15 years of sustained load. The stable columns were loaded to failure in a short time without unloading. The response of columns to load is predicted using a simple analysis and also a more complex analysis where the history of loading of individual concrete fibers is considered. It was possible to predict the load-deflection-time characteristics of concrete columns with complex loading histories.

2. THE TEST, THE SPECIMENS AND THE PROCEDURE

2.1 The Test

The histories of specimen loading are illustrated in Figure 1. Upon loading, deflections are present along the length of the column (Figure 1a). These deflections increase due to creep of the concrete in the column, thereby increasing the moments throughout the column length under sustained load.

Two possible loading histories are illustrated in Figures 1b and 1c for the column of Figure 1a. One history has creep buckling occurring at some time t_f under a sustained load, N_s (Figure 1b). The second is the failure at load N_f

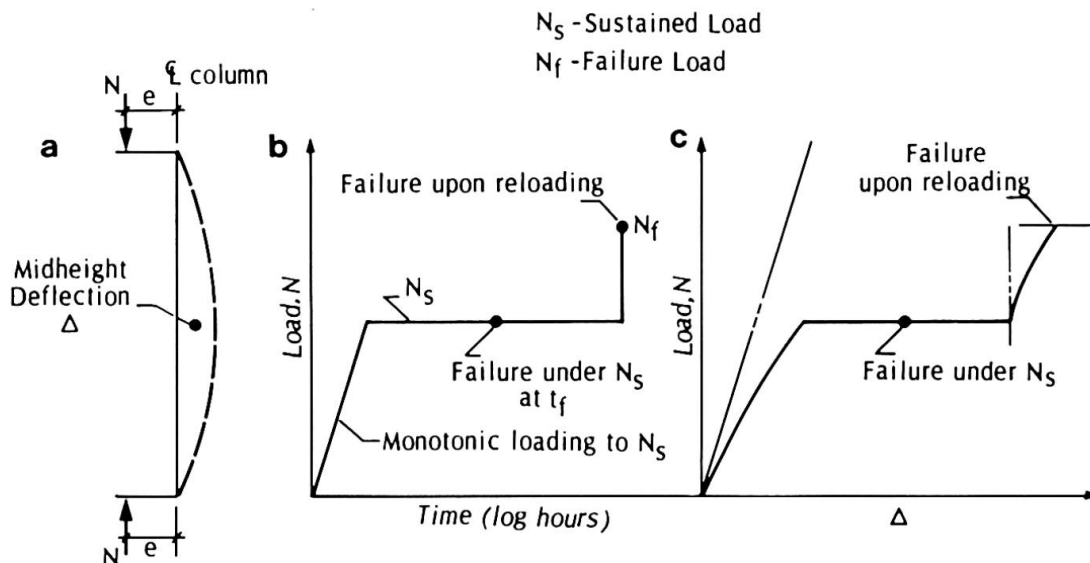

Fig. 1 Load Histories

developed due to further loading after a sustained load duration, t (Figure 1c). Data from columns having both loading histories obtained in the test series.

2.2 The Specimens

The specimens had a nominal cross section of 100 mm by 150 mm, a slenderness ratio (λ) of approximately 63, a reinforcement ratio (ρ) of 0.02, an average concrete cylinder strength of 28 MPa at the time of initial loading and an average reinforcing steel yield point of 420 MPa. Details of the specimen section are given in Figure 2.

A controlled environment was not available which would accommodate the ten specimens and associated equipment. A calculated risk was taken that the test house environment would correspond to that found near full size structural elements. The average temperature and relative humidity recorded at the test location over a 2 year period were 22°C and 65% respectively, with ranges of approximately 0°C to 35°C, and 35% to 95% respectively.

2.3 The Procedure

The loading system and instrumentation permitted the following:

- application of axial load, N , at a predetermined end eccentricity, e .
- measurement of axial load.
- maintenance of a sustained axial load to within approximately +3% and -5% of the desired value over the 14.5 year test period.
- test to failure without unloading the column.
- measurement of average curvature at various sections along the column length.
- deflections at several points along the column.

Full details of the test procedure are available [3] and an overall view of the test house is given in Figure 3.

Loads were applied through load cells and sustained using two 1/2 in. diameter prestressing strands linked to heavy duty coil springs. Columns were tested in a vertical position with the average age at initial loading of 49 days. Creep and shrinkage studies were carried out.

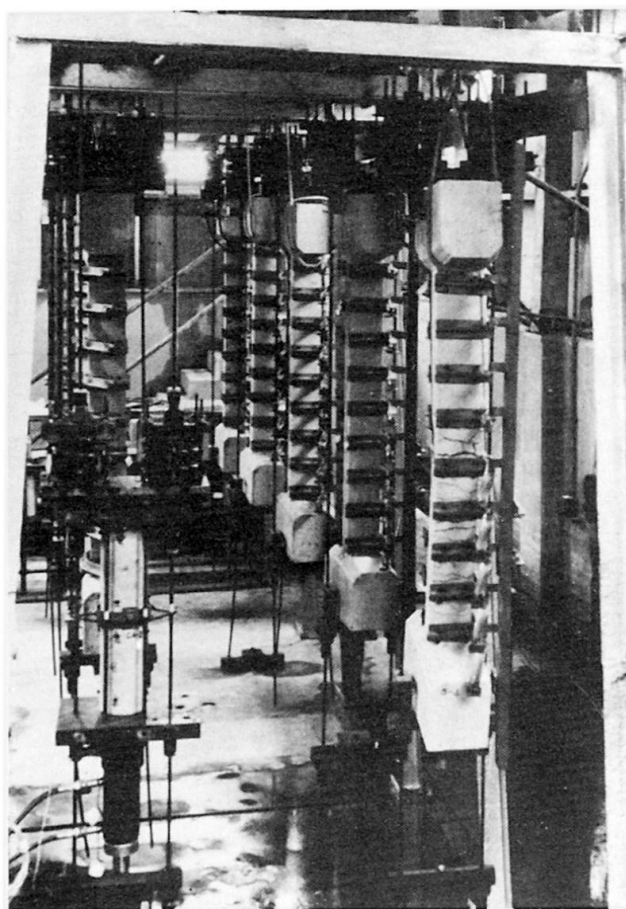
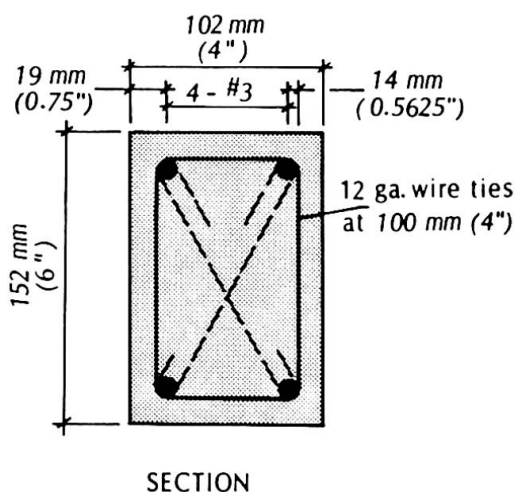

Fig. 2 Cross Section

Fig. 3 Test House

3. THE TEST RESULTS

In the absence of more detailed criteria, sustained load levels were chosen such that the calculated service (specified) axial load capacities of the columns based on ACI 318-63 [4] were exceeded. The ratio of sustained to service load ranged from 0.98 to 1.97. Service load capacities were calculated using the R-factor method of ACI 318-63, a capacity reduction factor of 1.0 and equal specified dead and live loads. Subsequent references to loads and capacities are not based on ACI 318-63, the Code available at the beginning of testing, but rather the most recent edition of ACI 318, published in 1983 [5]. Values of sustained load, failure load, failure time, and capacity ratios based on ACI 318, are given in Table 1 for the columns. Table 2 provides N_s/N_o values, N_s/N_c values and associated e/h values for all columns. Examination of Tables 1 and 2 indicates:

- good coverage in terms of N_s/N_o (0.18 to 0.47) and e/h (0.04 to 0.42) for a typical interaction diagram [1].
- ratios of sustained load to ACI 318 capacities varying from 0.90 to 1.40.
- sustained load failure of specimens having a \bar{N}_s ratio greater than 1.20.
- failure load capacities, \bar{N}_f , subsequent to sustained loading in excess of $1.20 \bar{N}_s$ for those columns still stable after 14.5 years under sustained load.

3.1 Typical Results

The load-midheight (maximum) moment results for two typical columns are given in Figure 4, together with an interaction diagram based on the cylinder strength of the concrete at initial loading. Column S1 failed due to creep instability following approximately 7.7 years of sustained load, which was in excess of the ACI 318-83 capacity. Column S7 failed due to instability, when reloaded after 14.5 years of sustained load, but at a load level in excess of the original short-time capacity predicted using ACI 318-83. The initial midspan deflections

Specimen	Sustained Load, N_s , kN	Failure Load, N_f , kN	Time at Failure t_f	Capacity Ratio*	
				\bar{N}_s	\bar{N}_f
S1	236	236	7.7 yrs	1.39	---
S2	121	176	14.0 yrs	0.92	1.33
S3	189	252 ⁺	14.0 yrs	0.92	1.23
S4	187	187	74 h	1.42	---
S5	185	185	4.9 yrs	1.19	---
S6	162	162	1037 h	1.22	---
S7	129	229	14.2 yrs	0.95	1.70
S8	133	167	14.4 yrs	1.09	1.37
S9	134	134	1 h	1.41	---
S10	80	102	14.5 yrs	0.95	1.20

⁺ Loaded to failure at 252 kN by increasing end moment

* Capacity ratio \bar{N}_s or \bar{N}_f , Ratio of N_s or N_f , if reloaded, to calculated capacity, N_u , using ACI 318-83, $\beta_d = 1.0$, $\phi = 1.0$.

Table 1



Number of Specimens	N_s/N_o	e/h	N_s/N_c
1	0.47	0.04	0.22
3	0.36 to 0.38	0.11, 0.16, 0.18	≈ 0.16
4	0.26 to 0.29	0.04, 0.15, 0.27, 0.42	≈ 0.12
2	0.18, 0.19	0.25, 0.42	≈ 0.085

Table 2

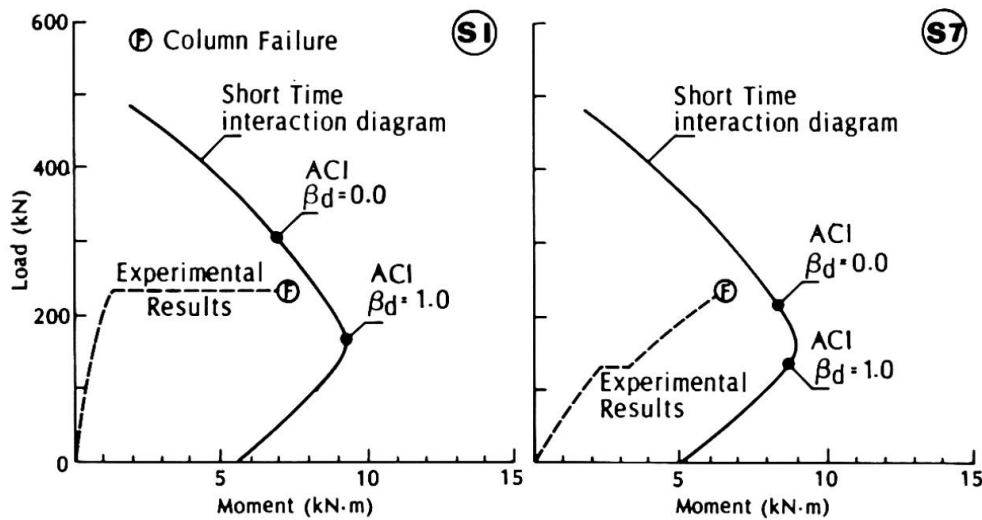

Fig. 4 Load Moment Values, Columns S1 and S7

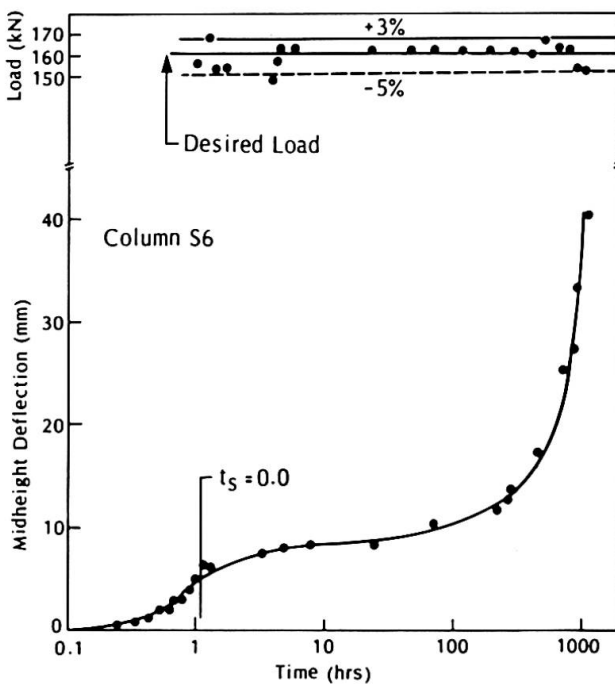

Fig. 5 Data, Column S6

for Column S1 increased by more than 15 times prior to failure. Deflections increased four-fold for Column S7.

Deflection-time data obtained from Columns S6 and S7 are given in Figures 5 and 6. Deflection increased rapidly as creep instability occurred (Column S6). Reference to the curvature meter data and associated surface strains indicated average strains on the "compression" face of Column S6 of 0.007 at approximately 1000 h. Powdering of the concrete on the compression face was observed just prior to failure. Also shown as part of Figure 6 are load-time data indicating load adjustment following creep shortening of the column. Some loss of sustained load occurred near failure. A gradual increase in deflection with time was found for Column S7 (Figure 7).

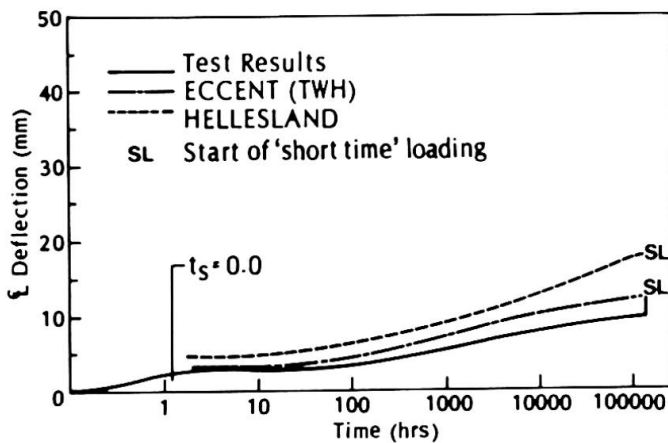

Fig. 6 Data, Column S7

The load-deflection data (Figure 7) illustrates an interesting feature of column response following sustained load. The initial portion of the load-deflection curve is slightly nonlinear as a consequence of secondary bending. Creep increases deflection with time. Upon reloading, there is an appreciable increase in the tangent stiffness value for the column. There was little warning before member failure and ductility appeared limited.

3.2 Material Characteristics

Companion creep tests carried out using 150 mm times 300 mm cylinders indicated a creep coefficient of 4.0 at 14 years. A shrinkage strain of approximately 200×10^{-6} at 14 years was observed. Cylinders cast and stored in the test house with the specimens, and then tested at 14.5 years had an average strength gain of 0.2 times the initial compressive strength.

4. ANALYSIS

An initial objective of the study [1] was to establish a simple and reasonably accurate model of column section behavior for the prediction of member response to short-time loading, sustained loading and short-time loading following sustained load. The model was to consider the accepted physical characteristics of concrete. Similar models applicable to uncracked reinforced or prestressed concrete members with low stress intensities have been developed recently [6].

4.1 Material and Section Model

Moment-curvature-time data (not shown) [1,3] obtained during the initial 0.6 years of the study were used to develop time-dependent-stress-strain (tdss) curves with the following characteristics:

- a parabolic form up to a maximum resistance of $0.95 f'_c$ at ϵ_o (≈ 0.002) and a descending branch, for short-time loading.
- a reduction in maximum resistance to $0.75 f'_c$ due to long-term sustained stress.
- a bilinear creep function applied to the short time stress-strain curve, based on Reference [7].
- a creep coefficient of 4.2 at 14 years.

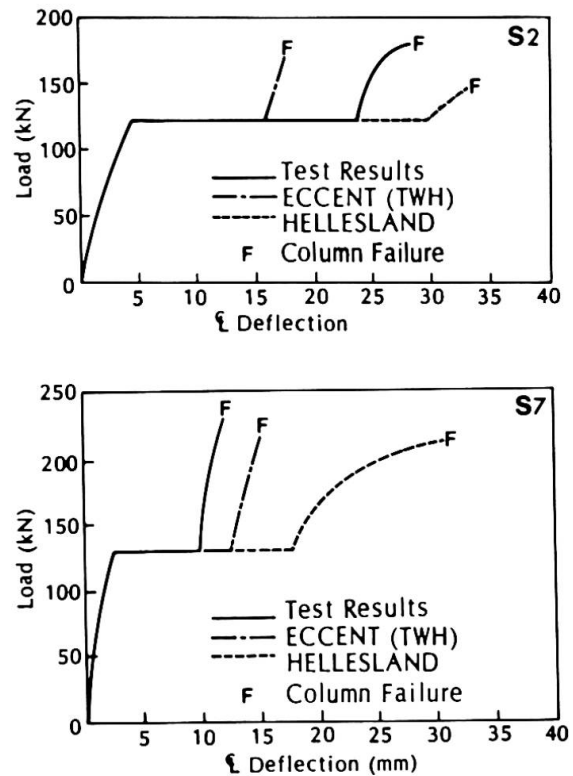

Fig. 7 Load-Deflection Values

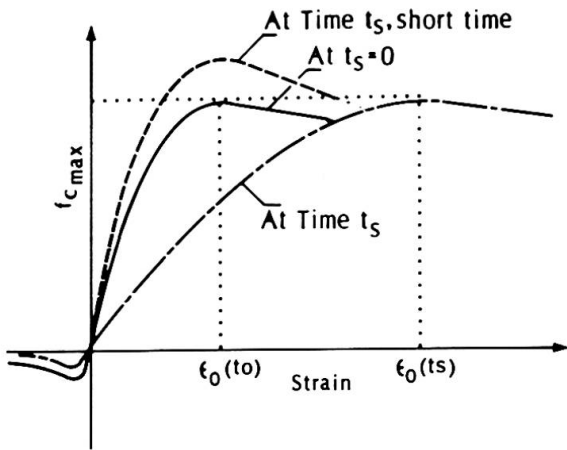

Fig. 8 TDSS Curves

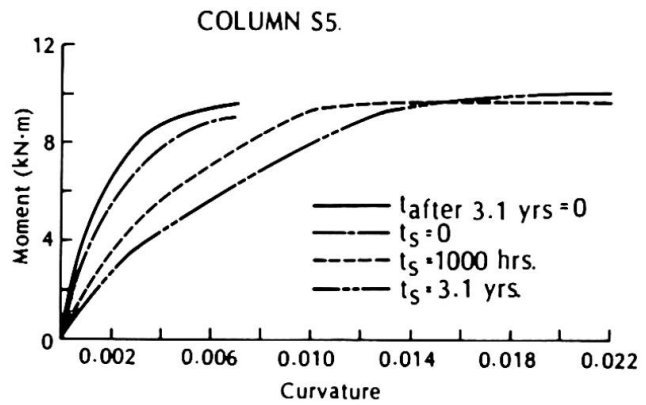

Fig. 9 M- ϕ -t Curves

Analysing the full 15 year data set, Traynor included hardening using a linear log time function for continued concrete hydration in predicting short-time concrete response subsequent to sustained loading [8]. A series of tdss curves (Figure 8) were developed to create a corresponding set of moment-curvature curves for a known section corresponding to a desired loading history (Figure 9). The moment-curvature data form input to a member analysis routine, Newmark's Method [9] in this case. For reloading after t_s , the deformed configuration due to sustained load was taken as an initial imperfection in the short time reloading analysis. Traynor developed the computer code ECCENT (TWH) for member analysis. The results obtained are identified in Figures 6 and 7 by the code name.

4.2 Member Model

Member responses were obtained from a quasi-static, single point collocation propagation analysis due to Helleland [10]. The model of the concrete fiber behavior includes creep, shrinkage, strength loss and hydration effects. Use of the model requires data about concrete strength, creep coefficient and shrinkage as well as member geometry. A uniform sectional behavior is assumed throughout the member.

4.3 Comparisons

Both the ECCENT (TWH) and Helleland analyses predict behavior satisfactorily

(Figures 6 and 7). In Figure 7, ECCENT (TWH) underestimates the deflection at the end of sustained loading period for Column S2 while the converse is true for Column S7. Failure loads are predicted well and the hardening after sustained load is reflected by the analysis. The Helleland Model predicts failure loads but underestimates the stiffness upon reloading (Figure 7). The rapid increase in midheight deflection under sustained load as failure approaches can be modelled using both analyses. However, predictions of failure time are difficult because of the

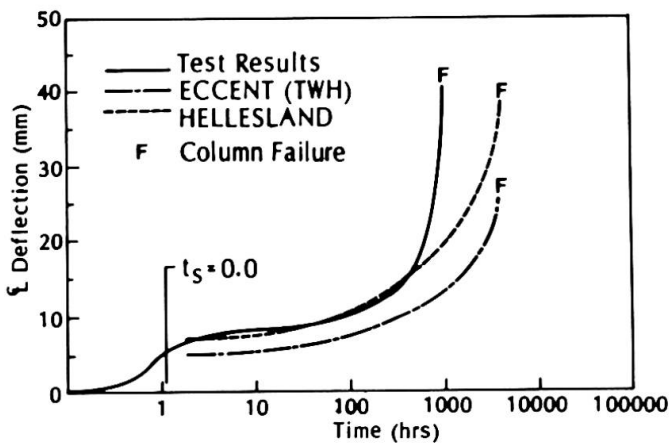

Fig. 10 Deflection-Time Results



uncertainty associated with prediction of concrete properties and short- and long-term deflections (Figure 10).

The following ratios were calculated in terms of observed to calculated values:

- failure times (logarithmic scale) ranged from 0.80 to 1.15 for both analyses.
- deflections including short-time and sustained loading, and reloading were between 0.8 and 1.6 at 14 years using the ECCENT (THW) analysis. (The Hellesland analysis tended to overestimate deflections upon reloading).
- ultimate capacities upon loading after sustained loading were 0.95 to 1.25 from both analyses.
- the ranges of the ratios quoted above are not unlike the deviations associated with the short-time behavior prediction of columns [11].

5. CONCLUSIONS

The results obtained indicate that it is possible to apply time-dependent-stress-strain curves to predict the response of eccentrically loaded columns to complex loading histories, if the creep coefficient and strength of the column concrete can be established. Such curves are easily applied in design practice. The test results provide confidence in the current calculation procedures advocated in ACI 318-83 for column strength under sustained load.

6. ACKNOWLEDGEMENTS

The authors wish to acknowledge the help of many individuals in Austin and Waterloo, who collected and reduced data; the use of the facilities at Austin and the sponsorship of NSF(USA) and NSERC(Canada).

7. NOTATION

e - eccentricity with respect to centroid, f'_c - concrete cylinder strength
 h - overall length of column, N_c - elastic critical load based on gross transformed section short time, N_f - axial load resulting in failure, \bar{N}_f - see Table 1, N_s - sustained axial load, \bar{N}_s - see Table 1, N_o = axial load capacity at zero eccentricity $\phi = 1.0$, t_f - time of failure, t_s - time under sustained load, ϵ_o - strain at maximum fiber stress, λ - slenderness ratio.

REFERENCES

1. GREEN, R., BREEN, John E., Eccentrically Loaded Concrete Columns Under Sustained Load. ACI Journal, Vol. 66, No. 11, Nov. 1969.
2. GAEDE, K., Knicken von Stahlbetonstaben unter Kurz-und Langzeitbelastung. Bulletin No. 129, Deutscher Ausschuss für Stahlbeton, 1958.
3. GREEN, R., Behavior of Unrestrained Reinforced Concrete Columns Under Sustained Load. Ph.D. Dissertation, U. of Texas, Austin, Texas, 1966.
4. ACI Committee 318, Building Code Requirements for Reinforced Concrete (ACI 318-63). American Concrete Institute, Detroit, 1963.
5. ACI Committee 318, Building Code Requirements for Reinforced Concrete (ACI 318-83). American Concrete Institute, Detroit, 1983.
6. DILGER, Walter H., Creep Analysis of Prestressed Concrete Structures Using Creep Transformed Section Properties. PCI Journal, Vol. 27, No. 1, 1982.
7. RÜSCH, H., Researches Towards a General Flexural Theory for Structural Concrete, ACI Journal, Vol. 57, No. 1, July 1960.
8. TRAYNOR, L., Sustained Load Behaviour of Unrestrained Reinforced Concrete Columns. M.A.Sc. Thesis, U. of Waterloo, Waterloo, Ontario, Canada, 1984.
9. NEWMARK, N.M., Numerical Procedure for Computing Deflections, Moments and Buckling Loads. ASCE Transactions, Vol. 108, 1943.
10. HELLESLAND, J., A Study into the Sustained and Cyclic Load Behaviour of Reinforced Concrete Columns. Ph.D. Dissertation, U. of Waterloo, 1970.
11. Stabiliteit, Report 77, CUR, The Netherlands, 1976.