

**Zeitschrift:** IABSE congress report = Rapport du congrès AIPC = IVBH  
Kongressbericht

**Band:** 12 (1984)

**Artikel:** Recent trends in the design and construction of cable-stayed bridges

**Autor:** Zellner, Wilhelm / Saul, Reiner / Svensson, Holger

**DOI:** <https://doi.org/10.5169/seals-12130>

### **Nutzungsbedingungen**

Die ETH-Bibliothek ist die Anbieterin der digitalisierten Zeitschriften. Sie besitzt keine Urheberrechte an den Zeitschriften und ist nicht verantwortlich für deren Inhalte. Die Rechte liegen in der Regel bei den Herausgebern beziehungsweise den externen Rechteinhabern. [Siehe Rechtliche Hinweise.](#)

### **Conditions d'utilisation**

L'ETH Library est le fournisseur des revues numérisées. Elle ne détient aucun droit d'auteur sur les revues et n'est pas responsable de leur contenu. En règle générale, les droits sont détenus par les éditeurs ou les détenteurs de droits externes. [Voir Informations légales.](#)

### **Terms of use**

The ETH Library is the provider of the digitised journals. It does not own any copyrights to the journals and is not responsible for their content. The rights usually lie with the publishers or the external rights holders. [See Legal notice.](#)

**Download PDF:** 22.01.2025

**ETH-Bibliothek Zürich, E-Periodica, <https://www.e-periodica.ch>**

## Recent Trends in the Design and Construction of Cable-Stayed Bridges

Développements dans le projet et la réalisation des ponts à haubans

Neuere Entwicklungen in Entwurf und Bau von Schrägkabelbrücken

### Wilhelm ZELLNER

Partner  
Leonhardt, Andrä und Partner  
Stuttgart, Fed. Rep. of Germany

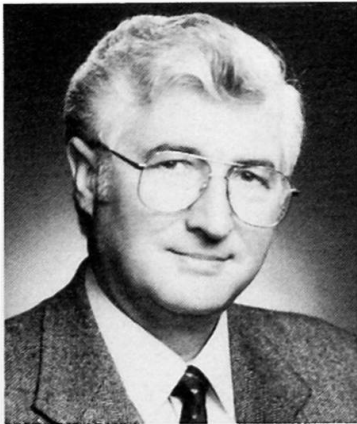

Wilhelm Zellner, born in 1932, Dipl.-Ing. of Civil Engineering, Univ. of Vienna, 1960. After two years supervision of the construction of a large bridge he joined Leonhardt, Andrä und Partner in 1962 and became a partner in 1970. He was responsible for the design of major bridges and structures, namely cable-stayed bridges.

### Reiner SAUL

Senior Superv. Eng.  
Leonhardt, Andrä und Partner  
Stuttgart, Fed. Rep. of Germany



Reiner Saul, born in 1938, Dipl.-Ing. of Civil Engineering, Univ. of Hannover in 1963. Four years with a steel contractor, since 1971 senior supervising engineer with Leonhardt, Andrä und Partner. He was responsible for the design, technical direction and checking of numerous long-span bridges, including also major rehabilitation works.

### Holger SVENSSON

Senior Project Eng.  
Leonhardt, Andrä u. Partner  
Stuttgart, Fed. Rep. of Germ.

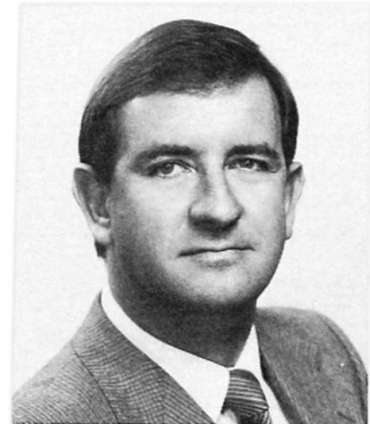

Holger Svensson, born in 1945, Dipl.-Ing. of Civil Engineering, Univ. of Stuttgart, 1969. After two years with a general contractor he joined Leonhardt, Andrä und Partner, where he works on all aspects of the design and construction of long-span, mainly cable-stayed bridges, including their protection against ship collision.

### SUMMARY

Recently constructed long-span cable-stayed bridges are surveyed. In competition mainly with concrete decks cable-stayed bridges with composite steel girders have of late proven very successful in North America. Their design and construction characteristics are outlined and the reasons for their success are given.

### RESUME

Des ponts à haubans récemment construits sont examinés. En Amérique du Nord, les ponts à haubans sont devenus très compétitifs, par rapport aux ponts en béton. Les particularités du projet et de la réalisation ainsi que les raisons de leur succès sont expliquées.

### ZUSAMMENFASSUNG

In jüngster Zeit gebaute Schrägkabelbrücken werden untersucht. Im Wettbewerb hauptsächlich mit Betonbrücken haben sich Schrägkabelbrücken mit Verbundbalken letzthin in Nordamerika als sehr erfolgreich erwiesen. Ihre Besonderheiten in Entwurf und Bauausführung werden beschrieben und die Gründe für ihren Erfolg erläutert.



## Dedicated to Professor Fritz Leonhardt

on the occasion of his 75th Anniversary in respectful appreciation of his decisive contributions to the development of modern cable-stayed bridges

### 1. INTRODUCTION

Since the IABSE survey on cable-stayed bridges in 1980 [1] significant new developments have taken place as outlined in Table 1 and Fig. 1.

Girder material	No	Name	Country	Completed	Main Span
Steel	1	Severin	Germany	1959	302
	2	Knieflehe	Germany	1969	320
	3	Duisburg-N.	Germany	1971	350
	4	St. Nazaire	France	1975	404
	5	Meikonishi	Japan	1984	405
	6	Hitsuishijima	Japan	1988	420
	7	Yokohamakoh	Japan	1989	460
Asymmetric, doubled with free cantilever length	(2)	Knieflehe	Germany	1969	2x318=636
	(8)	Flehe	Germany	1979	2x324=648
Concrete	9	Dniepr	USSR	1976	300
	10	Brotonne	France	1977	320
	11	Barr. d. Luna	Spain	1983	440
Asymmetric, doubled with free cantilever length	(12)	E. Huntington	U S A	1984	2x233=466
Composite	13	Hooghly	India	1987	457
	14	Annacis	Canada	1988	465

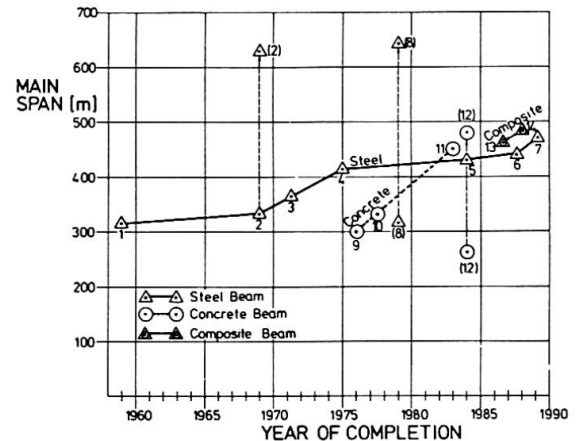

Table 1

Cable-stayed record main spans in the order of their completion

Fig. 1

From the very beginning of modern cable-stayed bridges those with steel beams always had the longest main spans [2]. This changed in 1983, when the lead went to a bridge with a concrete beam, the Barrios de Luna Bridge in Spain, with a main span of 440 m [3]. This span length will be exceeded soon by two bridges presently under construction with composite beams. These bridges are the Hooghly River Bridge, Calcutta, India (main span 457 m) and the Annacis Bridge, Vancouver, B.C. (main span 465 m). If, however, the main span lengths of asymmetric cable-stayed bridges with only one tower were doubled by adding a second, symmetric half, the Rhine Bridge Flehe would have the longest steel span with 648 m, followed by the Knieflehe Bridge with a 636 m span. The longest concrete main span would then belong to the East Huntington Bridge with 466 m, see Table 1 and Fig. 1.

The occurrence of composite beams indicates an important future trend in the design and construction of cable-stayed bridges. This is best illustrated with recent bidding results from the US and Canada, where two official designs with different materials for the girder were tendered, Table 2.

Cable-stayed Bridge	Year of Bid	Bid Prices (Mio US-\$)			Cost Ratio		
		Conc	Steel	Composite	Steel Concrete	Composite Steel	Composite Concrete
Dame Point	1979	64,8	84,8		1,31	-	-
East Huntington	1981	23,5	33,3		1,42	-	-
Sunshine Skyway	1982	71,1		73,8	-	-	1,04
Weirton-Staubenv.	1983	no offer	32,6	19,9	-	0,61	-
Annacis	1984	56,0		45,8	-	-	0,82
Quincy	1984	no offer		17,2			17,2 /-

Table 2 Bidding results for cable-stayed bridges in competitive bidding in North America, from [8]



Bridges with an all-steel beam were, for spans up to 400 m, always significantly more expensive than those with a concrete beam. The steel composite alternate for the Sunshine Skyway Bridge, instead, tendered in 1982, lost in competitive bidding against the concrete alternate by only 4 % [4]. All subsequent 3 competitive biddings were won clearly by the composite alternates, with the vast majority of contractors bidding this solution.

No	Name	Country	Year compl.	Main Span (m)	Total <sup>1)</sup> Length (m)	Traffic Type	Designers
1	Strömsund	Sweden	1956	183	332	Road	DEMAG/Dischinger
2	Büchen Br.	Germany	1956	59	85	Road	Gollnow & Sohn
3	Sitka Harbor	U S A	1975	137	229	Road	Gute & Nottingham
4	Heer-Agimont	Belgium	1975	124	202	Road	Bureau des Ponts
5	Tilff	Belgium	1976	52	71	Pedestr.	Jennehomme & Jodssin
6	Arnhem	Holland	1977	36	86	Pedestr.	C. Pet
7	Sieglang.Br.	Austria	1977	86	146	Pedestr.	Horst Passer
8	Steyregg.Br.	Austria	1979	161	242	Road	VOEST-Alpine
9	Skyway	U S A	--	366	659	Road	Greiner Eng. Sc. with Leonhardt, Andrä u. P. Michael Baker Corp.
10	Weirton-St.	U S A	under constr.	250	460	Road	Leonhardt, Andrä u. P. with Michael Baker Corp.
11	Hooghly R.Br.	India	under constr.	457	823	Road	Leonhardt, Andrä u. P. with Schlaich u. P.
12	Annacis	Canada	under constr.	465	931	Road	Buckland & Taylor with CBA Engineering
13	Quincy	U S A	under constr.	274	543	Road	Modjesky & Masters
14	Savannah	U S A	under design	305	564	Road	Greiner Eng. Sc. with Leonhardt, Andrä u. P.

Table 3

Cable-stayed bridges with composite beams

1) Stayed Spans

A survey on cable-stayed bridges with composite beams is given in Table 3. It is interesting to note that the first modern cable-stayed bridge, the Strömsund Bridge in Sweden, was already built with a concrete roadway slab, although it was used in this case only for the transfer of local wheel loads to the steel grid. All recorded cable-stayed all-steel bridges completed or under construction after 1982 are located in Japan. A recent survey on cable-stayed bridges in Japan [5] shows that a total of 20 major bridges are currently in various states of progress.

It is worthwhile to mention that China started to build cable-stayed bridges in 1975, having completed 11 bridges of this type to date, all with concrete girders and towers, Table 4.

No	Name	Year opened for Tr.	Main Span (m)	Total <sup>1)</sup> Length (m)	Traffic
1	Yunyang Bridge, Sichuan	1975	76	146	Highway
2	Songjiang Xinwu Bridge, Shanghai	1975	54	102	Highway
3	Dagu River Bridge, Qing Dao	1977	104	196	Highway
4	Ankang Hanjiang Bridge, Shan Xi	1979	120	192	Highway
5	Changxindao Bridge, Liaoning	1980	176	342	Highway
6	Santai Fujiang Bridge, Sichuan	1980	128	240	Highway
7	Hongshui River Bridge, Guang Xi	1981	96	192	Railway
8	Jinchuan Bridge, Sichuan	1981	71		Highway
9	Jian Huanghe River Bridge, Shandong	1982	220	488	Highway
10	The Mao River Bridge, Shanghai	1982	200	370	Highway
11	Shangyu Zhang Zhen Bridge, Zhejiang	1983	72	126	Highway

Table 4

Cable-stayed bridges in China

1) Cable-Stayed Spans



## 2. GENERAL LAYOUT

For bridges over large waterways the main span lengths are increasingly governed by considerations in the prevention of ship collision with piers or superstructure [6], [7]. The safest solution is always to place the piers out of the reach of ships. Otherwise the piers have to be protected, e.g. by artificial islands or made strong enough to withstand the collision impact force.

The side span lengths depend mainly on the ratio of beam dead weight to live load, see [1, Table 7]. In order to keep the uplift forces at the anchor piers small, long side spans are required. However, such long side spans may cause the backstay cables to be unloaded too much by live load in the side spans and to be subjected, for a given live load, to very high fatigue stresses.

The cable spacing in the longitudinal direction is governed by two adverse considerations:

- short distances are required for a beam erection without intermediate supports in order not to exceed single cable capacities, to achieve a uniform cable force introduction at the beam and to keep the simple span moments between cables small
- long distances are required in order to reduce the number of cables and girder sections to be installed.

Suitable cable distances for concrete girders lie between 5 and 10 m, for composite girders between 10 and 15 m and for all-steel girders between 15 and 25 m.

## 3. BEAMS

### 3.1 Concrete Beams

Typical beam cross-sections of recent long-span cable-stayed concrete bridges consist of rather flat boxes, Fig. 2. For shorter spans solid slabs have been

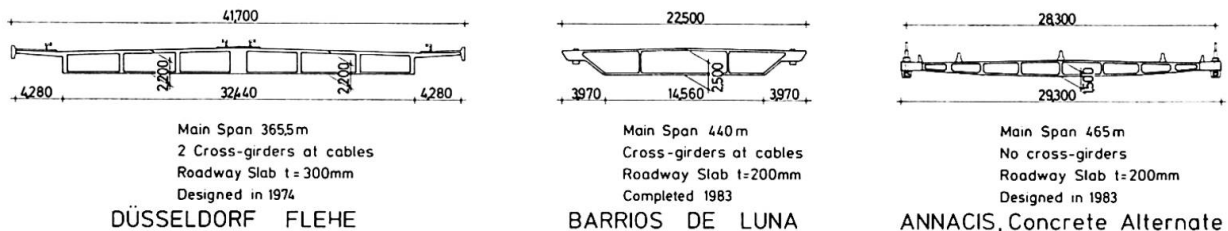

Fig. 2 Cross-sections of long-span cable-stayed concrete bridge beams

proposed. For such cross-sections with a maximum stiffness for a given depth bending stresses are minimized. The small depth renders a torsionally weak beam, so that two outside cable planes are necessary.

### 3.2 Composite Girders

The overriding consideration for a cable-stayed composite beam is to keep the tensile stresses in the concrete roadway slab as small as possible. This is best achieved by inverted U-shapes where the center of gravity is located very close to the concrete topping, Fig. 3.

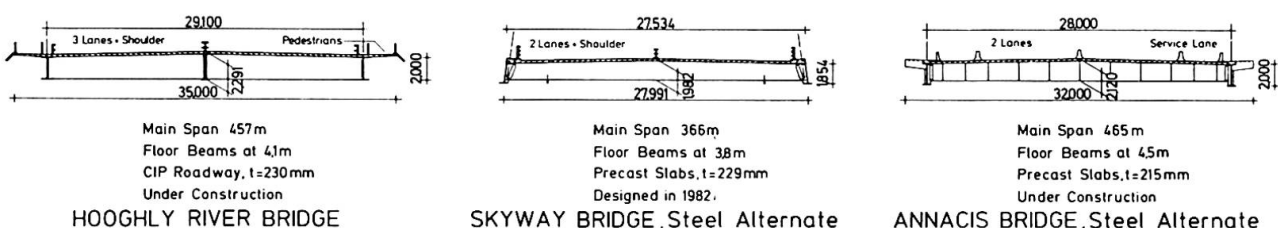

Fig. 3 Cross-sections of long-span cable-stayed composite bridge beams



The cables are directly anchored to the outside main girders so that very little torsional beam stiffness is required; the overall torsional stiffness may be increased by converging the cables at the top of an A-shaped tower, [4].

The bending moments are mainly carried by the steel grid, whereas the significant compression forces from inclined cables are mainly taken by the concrete deck slab, whose shrinkage and creep can be kept low, e.g. by using well matured precast slabs, Fig. 4., and a concrete mix with a low water/cement ratio and superplasticiser. In this way the ratio of  $E_{\text{steel}}/E_{\text{concrete}}$  after shrinkage and creep, may come to only about 11 [4], whereas for a cast-in-place deck this ratio is in the range of 20. This means that the concrete participation for long-term loads for a cast-in-place roadway is only about one half as effective as for precast roadway slabs.

The precast slabs should be connected with staggered cast-in-place joints located at the points of counterflexure between floor beams across which the slab reinforcement is lapped, Fig. 4.

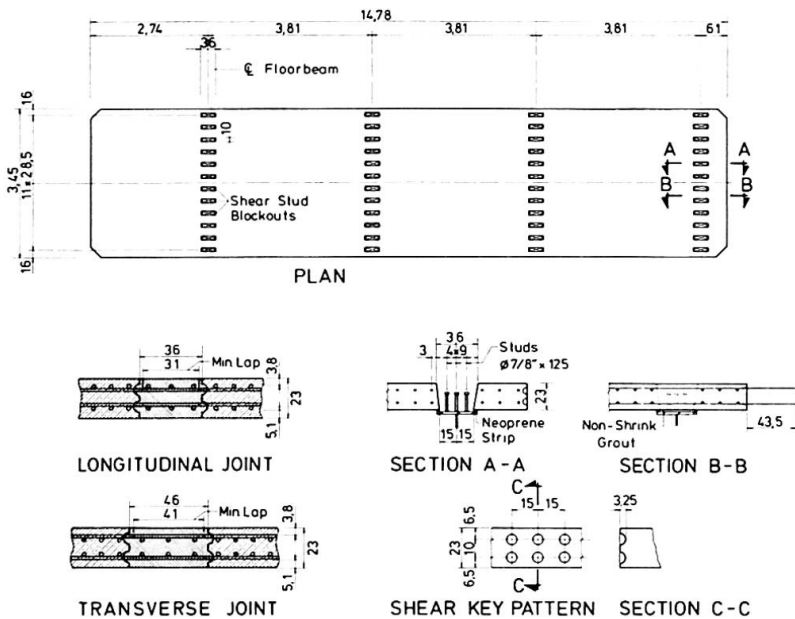

Fig. 4

Precast deck slabs and their joints as proposed for the Sunshine Skyway Bridge, Steel Alternate, from [4]

Compression forces in the roadway slab in addition to those from inclined cables may be created by choosing positive moments in the beam under permanent loads, e.g. in the bridge center and near the anchor piers. Prestress in the roadway slab can be avoided by providing a sufficient amount of closely spaced rebars for crack control.

#### 4. TOWERS

The trend for towers appears to go away from the more complicated A- and diamond shapes to simpler, possibly modified H-shapes, Fig. 5. The cables form two straight vertical planes intersecting the tower axes in the anchorage region.

The tower material will generally be concrete, as the cost of compression members from concrete is only about 2/3 of those from steel. Only extremely bad soil conditions may occasionally favor steel towers.

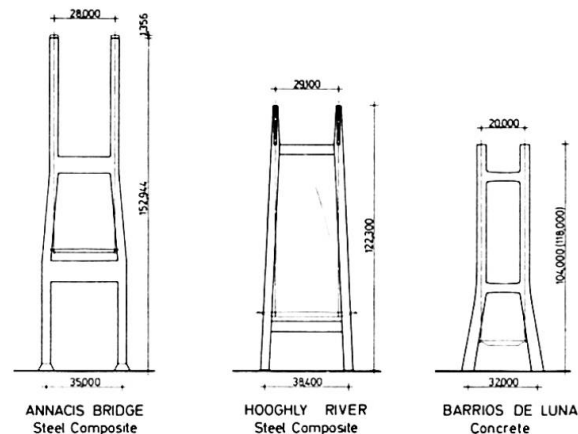

Fig.5 Tower shapes for recent long-span cable-stayed bridges

#### 5. CABLES

The general trend for cable arrangement is to discontinue the corresponding fore-and backstay cables at the towers and to anchor them separately, e.g. in order to permit exchange of any single cable. A new type of cable anchorage for a steel or composite girders is shown in Fig. 6.



**Fig. 6** Stay cable anchorage at composite girder

A new development for stay cables may be the use of polythylene (PE) extruded onto galvanized wires or strands for corrosion protection. New methods have also been developed for fabricating parallel strand cables from components on site in their final location, e.g. for the bridge Barrios de Luna.

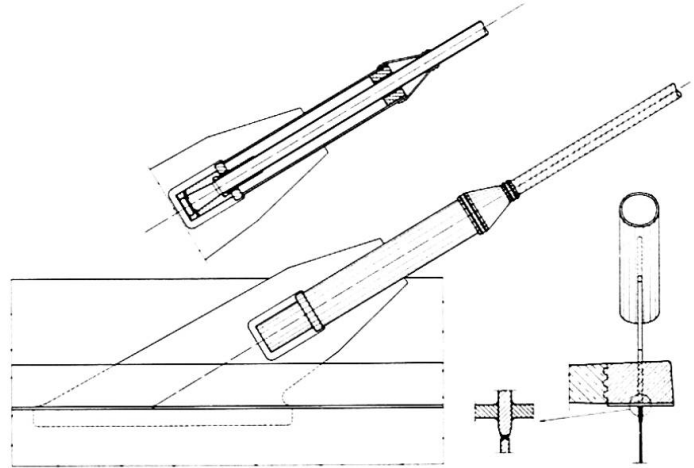

## 6. SUMMARY AND CONCLUSION

The recent great success of cable-stayed bridges with composite girders has two main reasons:

- the manhours required for fabrication and erection of a concrete roadway slab are significantly lower than for an orthotropic steel deck
- the girder segments for a composite beam can be split up during erection into steel grids and precast slabs, with each component having much smaller weights than the corresponding complete concrete beam sections.

For shorter spans below about 250 m concrete beams with solid slab cross-sections and two cable planes may be appropriate. However, for spans above that, composite beams with inverted U-shaped girders and two cable planes may be predominant. Steel beams with an orthotropic deck are restricted to very long spans ( 700 m), heavy live loads, bad soil conditions and/or difficult erection conditions.

## REFERENCES

- [1] LEONHARDT F. and ZELLNER W., Cable-stayed Bridges. IABSE Surveys S-13/80, p. 21 to 48.
- [2] WEITZ F.R., Schrägseilbrückensysteme als Beispiel für Entwicklungstendenzen im modernen Großbrückenbau (Cable-Stayed Bridge Systems as an Example of Development Trends in Modern Long-Span Bridge Construction). Thyssen Technische Berichte, Vol. 1/83, p. 40 to 59.
- [3] ZELLNER W. and SVENSSON H., Zur Entwicklung der Schrägkabelbrücken aus Beton (On the Development of Cable-Stayed Concrete Bridges). Spannbetonbau in der Bundesrepublik Deutschland, IX. International CEB Congress Stockholm 1982, p. 82 to 85.
- [4] SVENSSON H., SAUL R., ANDRÄ H.-P. and SELCHOW H.-J., Design of a Cable-Stayed Steel Composite Bridge. Journal of Structural Engineering, ASCE 1984
- [5] TANAKA Y., Major cable-stayed bridges under construction or planned in Japan. Shinko Wire Company, Ltd., Amagasaki, Nov. 1983.
- [6] SAUL R. and SVENSSON H., On the Theory of Ship Collision against Bridge Piers. IABSE Proceedings P-51/1982, p. 29 to 38.
- [7] SAUL R. and SVENSSON, H., Means of Reducing the Consequences of Ship Collision with Bridges and Offshore Structures. IABSE Colloquium on Ship Collision with Bridges and Offshore Structures, Introductory Report, Copenhagen 1983, p. 165 to 179.