

**Zeitschrift:** IABSE congress report = Rapport du congrès AIPC = IVBH  
Kongressbericht

**Band:** 14 (1992)

**Rubrik:** Seminar 5: Urban transport structures

### **Nutzungsbedingungen**

Die ETH-Bibliothek ist die Anbieterin der digitalisierten Zeitschriften. Sie besitzt keine Urheberrechte an den Zeitschriften und ist nicht verantwortlich für deren Inhalte. Die Rechte liegen in der Regel bei den Herausgebern beziehungsweise den externen Rechteinhabern. [Siehe Rechtliche Hinweise.](#)

### **Conditions d'utilisation**

L'ETH Library est le fournisseur des revues numérisées. Elle ne détient aucun droit d'auteur sur les revues et n'est pas responsable de leur contenu. En règle générale, les droits sont détenus par les éditeurs ou les détenteurs de droits externes. [Voir Informations légales.](#)

### **Terms of use**

The ETH Library is the provider of the digitised journals. It does not own any copyrights to the journals and is not responsible for their content. The rights usually lie with the publishers or the external rights holders. [See Legal notice.](#)

**Download PDF:** 08.02.2025

**ETH-Bibliothek Zürich, E-Periodica, <https://www.e-periodica.ch>**



## **Seminar 5**

### **Urban Transport Structures**

**Structures dans les transports urbains**

**Bauwerke für städtische Transportsysteme**

Organizer: John Breen,  
USA

Leere Seite  
Blank page  
Page vide

## Innovation and Evolution of Urban Transportation Structures

Développements innovateurs des structures de transport urbain

Innovation und Evolution bei städtischen Verkehrsbauwerken

**Charles W. DOLAN**  
Assoc. Prof.  
Univ. of Wyoming  
Laramie, WY, USA



Charles Dolan received his PhD from Cornell University in 1989 after working over 20 years as the designer of urban transportation guideway structures.

### SUMMARY

Advancements in transit guideway design and construction require understanding the transit vehicle technology, the structure, and the urban cityscape. Economies and originality may be promoted by capitalizing on the unique features of transit systems. The historical development of transit guideways is presented and the contributions and benefits of several systems are described. Lessons from these developments and from speciality transit structures can benefit new guideway installations.

### RÉSUMÉ

Les progrès dans l'étude et la construction des voies de circulation à guidage implique la connaissance approfondie de la technologie des véhicules de transport, de la structure et du paysage urbain. Il est possible de parvenir à des ouvrages originaux et économiques en tirant profit des particularités exceptionnelles des systèmes de transit. L'article présente l'historique du développement des voies de circulation à guidage et décrit les apports et les avantages de plusieurs systèmes. Les leçons tirées de ces développements et des structures spéciales de ce moyen de transport peuvent profiter à de nouvelles installations de voies de circulation à guidage.

### ZUSAMMENFASSUNG

Fortschritte bei Entwurf und Bau des Fahrwegs spurgeführter Transitsysteme verlangt Verständnis der Fahrzeug-Technologie, des Fahrweg-Tragwerks und der Stadtlandschaft. Wirtschaftlichkeit und Originalität können gefördert werden, indem man Vorteile aus dem besonderen Merkmalen des Transitsystems zieht. Präsentiert werden die historische Entwicklung der Fahrbahntypen sowie die Beiträge und Vorteile der verschiedenen Systeme. Lehren aus diesen Entwicklungen und speziellen Fahrbahn-Tragwerken können bei der Installation neuer spurgeführter Systeme nützlich sein.





## 1. HISTORICAL BACKGROUND

Virtually all transit systems evolved from the horse drawn streetcars and mine carts. These common ancestors of modern transportation provide the underlying basis for transit and guideway development. As the railroads evolved, it was only logical that transit technology benefit from the advances in rail technology. While steel rail and steel wheels formed the basis for transit development, the sources of propulsion were varied. In the 1880's over 5800 km of transit track criss-crossed the cities of the United States [1]. The majority of the transit vehicles were horse drawn cars riding on rails in the city streets. Yet even at this time horses were in decline and by the end of World War I all horse drawn transit had disappeared from the United States.

In the 1870's San Francisco, California opted to use a cable system to propel its vehicles over the steep hills. Provision of equipment to align, support and guide the cables became one of the first transit "guideway" projects. In other parts of the world, electricity was replacing horses as the power source for transit. In general, guideways remained as steel rails placed in the street.

Elevated transit was the solution to the increasingly crowded city streets. In 1866, Charles T. Harvey designed and constructed a quarter mile section of elevated track in Yonkers New York. The cable driven vehicle was a prototype of a proposed 23 km transit system. The vehicle operated at 23 km/hr, however the system was never completed due to instability of the financial markets.

The first successful elevated transit systems were installed in the United States in the late 1800's. The Chicago Elevated transit system was begun in 1892 and is still in service. The Philadelphia transit system began as a streetcar service, but increased demand required larger cars, and eventually, elevated sections of guideway were constructed to support the commuter rail service.

The early guideway systems consisted of riveted steel structures and tie and rail tracks. The impact on city is immense. Entire city blocks covered by steel and timber. Track and switch technology came directly from the railroads. Noise suppression and aesthetics were not considered part of the design criteria and the resulting impact of noise and urban intrusion is still evident.

Repair and maintenance was of little concern on these early structures. Transit service was more than adequate at the turn of the century. Today, however, traffic volume is so great that agencies such as the Chicago Transit Authority can replace only a few ties per day on heavily traveled lines. Closing lines to create more effective working conditions to implement repairs is impossible due to the heavy ridership.

## 2. SPECIALIZED GUIDEWAYS AND VEHICLES

While specialized transit had its beginning with the Harvey "monorail" in NYC in the late 1860's. Other creative systems were more successful. The "swaying" monorail over the Wupper River in Wuppertal, Germany is a notable example. The suspended vehicles are hung from a guideway structure constructed over the Wupper River. Not only is the guideway specially designed to provide the support, guidance and power to the vehicle, but the use of the river directly addressed the issues of noise and urban space utilization.

Guideway design and development progressed incrementally for the next several decades. Innovations were primarily in the vehicle technology and supporting systems. The President's Conference Car, PCC, in the late 1920's standardized a vehicle design in the United States. The PCC vehicle allowed some degree of guideway standardization. Better electric motors and better signaling improved performance, safety and reliability.

Specialty transit, such as cable cars were developed and died out. The San Francisco cable car system is one remaining historical cable guideway system still in operation. Newer cable systems, such as the peplemover at Circus-Circus resort in Las Vegas, Nevada are modern applications of a proven technology. The systems provide transit access between facilities separated by major roads or natural barriers.

## 3. MODERN CONCRETE GUIDEWAYS

The 1960's inaugurated a new era of guideway structural development with two very different technologies; the Alweg monorails at Seattle Washington and Walt Disney World and the Bay Area Rapid Transit project. The Seattle Monorail was constructed

For the 1962 World's Fair in Seattle, Washington, the Disney World Monorail began in 1969, and construction commenced on the Bay Area Rapid Transit (BART) system in San Francisco, California in the mid 1960's. Though vastly different in form and function, monorail and BART projects had an important effect on guideway development for the remainder of the century.

The Alweg Monorail system was developed in the 1950's in Sweden. The monorail guideway is a fully integrated structure. The top surface provides the riding surface, while the sides provide both the steering surface and vehicle retention. Inserts in the sides allow mounting the power rail and signal control systems.

A small monorail system was constructed at Disneyland, in Anaheim California in the late 1950's. The monorail used reinforced concrete beams cast in tangent or circular forms. The resulting transit system, while suitable for the park environment, had many shortcomings. The most significant deficiency was the long term sag that developed in the concrete beams. The discontinuities led to undesirable ride quality conditions.

The Alweg corporation received the contract to design, construct and operate a full size monorail system between downtown Seattle and the World's Fair site in 1962. The Alweg guideway design was predicated on using a prestressed concrete. Prestressing allowed improvement in the ride quality by the elimination of the long term sag conditions which occurred in the Disneyland system. Construction of the Seattle beams pioneered new construction innovations. The most significant concept was the use of adjustable forms to allow the geometric alignment to be integrated into each beam.

The adjustable form allowed high rates of production for a large number of variable members. The net effect of the prestress force in the Seattle monorail was to create a beam with substantial upward camber. Just as the sag in the reinforced concrete beams in Anaheim affected the ride quality, the camber also detracted from a smooth ride in Seattle.

The Walt Disney World monorail was designed and constructed in Orlando, Florida in 1969-1971. The monorail provides the primary transportation link between the parking lots and the Magic Kingdom, Figure 1. The monorail guideway at Disneyworld was an evolutionary step forward from previous designs. The guideway beams were completely integrated structures, prefabricated in adjustable forms to very precise tolerances [2]. The forms were designed to flex horizontally while adjustable soffit and top chamfers provided the vertical tolerances. High production rates allowed the fabrication of one beam per form per day, even with the large number of geometric changes. The prestress force was designed to produce a long term axial shortening without camber or sag. Continuity was employed to reduce the interior joints, improve ride quality and provide structural redundancy. Computer aided design and manufacturing techniques allowed coordination of the site geometry with the precast manufacturing.



Fig 1. Walt Disney World Monorail

Switches were installed in the main line of the Walt Disney World monorail structure to facilitate entry and egress of trains to the main loop from the maintenance sidings. These switches and switches used in the Japanese monorail systems have proven to be quite functional and reliable over the decades [3].

The San Francisco Bay Area Rapid Transit, BART, was an even greater forward step [4,5,6]. For the first time in decades, engineers attempted to completely define the transit technology. Vehicles would run on steel rails, but beyond that substantially new technology was incorporated in the design. The BART cars had a non-standard



wheel gage, automated control system, wayside power instead of overhead catenary and vehicles designed for ride comfort.

The BART guideway received considerable engineering attention. The guideway beams were to be fabricated of precast concrete. Entire beam segments were cast as complete units and shipped to the site. Beams were made in tangent and curved sections, however, the trackwork was not directly integrated into the beams. The guideway consisted of simple span beams with expansion joints at each end. The rails were fastened directly to the structure by using rail fasteners embedded in a "second pour" concrete segment.

The second pour accomplished two objectives. First, the rails could be electrically isolated from the main beam. This was an important consideration since the continuously welded rails also carried the ground current of the propulsion system. Secondly, the extra concrete placement allowed minor tolerance adjustments to be made without having to adjust the entire structure.

The continuously welded rails and wider body vehicles substantially improved ride quality on the system. The thermal forces generated in the continuously welded rail limited the span capacity to simple spans. Since the beams must expand and contract independently of the rail, structures longer than a single span accumulate too much residual stress.

#### 4. STEEL GUIDEWAYS

The noise and vibration of the Chicago Elevated transit system would not be tolerated in a modern urban transit system. Since these systems use predominately steel structures and the cost of steel was relatively high, steel was not the material of choice when new transit systems were started in the 60's. Nonetheless, composite steel and concrete guideways have evolved as a cost effective acceptable transit guideway alternative. The composite concrete top allows adjustment of tolerances in the field, provides damping for vehicle noise and increase the stiffness of the structure.

Steel allows light weight initial construction and welding makes continuity easy to achieve. Advances in computerized cutting welding and assembly are providing new opportunities for steel structures. Steel beams may also be used with concrete tops for guideways. Both the Atlanta, Georgia and the Washington D.C. transit systems use composite steel guideways.

Elevated guideways for Westinghouse people movers have used steel guideways very effectively, figure 2. Steel WF sections are used for the primary structure and channels are placed on the top flange to increase the section modulus. The channels are filled with concrete to provide the final riding surface. Not only may tolerances be set in the field, but the concrete provides an superior tractive surface for the rubber tired vehicle.

Low velocity peplemover monorails have adapted advanced fabrication technologies to produce light weight, cost effective structures, figure 3. Beam elements are fabricated for individual spans then welded into a continuous structure. Automated welding techniques reduce the cost of fabrication. Hitachi has developed curved steel guideway beams for its monorail system and steel beams are frequently used for monorail switches.



Fig. 2 Westinghouse Guideway  
Kings Dominion, Virginia

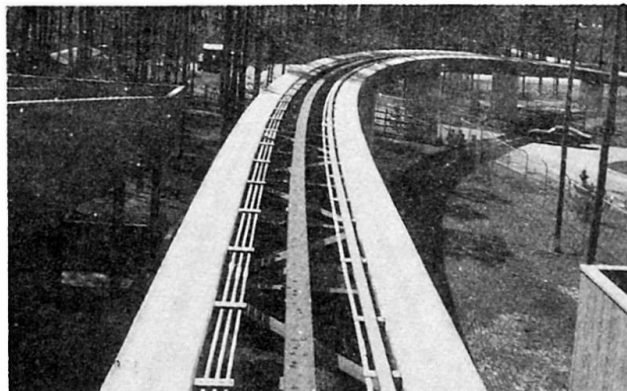

Fig. 3 Minneapolis Zoo  
Monorail



#### 4. ENGINEERING INTEGRATION

Throughout this process the structural engineer served as the primary integrator of the technology. In successful designs, the structural engineer incorporated the requirements of the vehicle technology and ride quality, the power supply, the signal systems and the construction industry to complete designs that were economical and aesthetically acceptable.

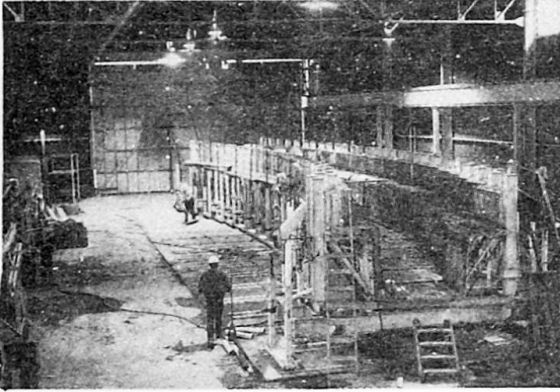

Fig. 4 Adjustable Form for Box Girder Beam Fabrication

High precision adjustable formwork for the variable geometry was a technological breakthrough that continues to benefit guideway design and fabrication. The Vancouver, British Columbia, Canada ALRT and the Detroit, Michigan Downtown People Mover extended the adjustable form technology to box beam sections used rail supported transit systems [7]. Complex forms, figure 4, not only provided the precise geometry needed for the complex route geometry, but also provided fixed cast-in inserts for mounting the rail fasteners and other system hardware. The Vancouver and Detroit systems use two span continuous structures with low friction rail anchors to limit the residual stresses.

The 35 meter radius curves create very large radial forces when thermal expansion of the rails occurs. Consequently, the Detroit system uses expansion joints to relieve the residual rail forces in the guideway. Expansion joints are placed at or near the stations to reduce noise created by the vehicle moving over them.

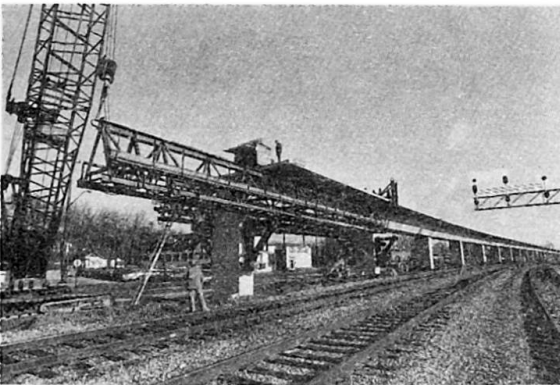

Fig 5. Segmental Construction of the Atlanta Transit System  
(Courtesy of Figg Engineering Group)

The Metropolitan Atlanta Rapid Transit Administration, MARTA, used another variation of adjustable form casting on a particularly difficult section of their line. Constructing the guideway adjacent to an in-service freight rail right-of-way posed significant construction impediments. Designers elected to use segmentally precast field post-tensioned segmental box beams to solve this problem. The segments could be lifted onto falsework quickly and cranes could work out of the train right of way, figure 5. The smaller precast pieces could be erected on a schedule which allowed uninterrupted train service below.

#### 5. SPECIALTY TRANSIT HYBRID PRECAST CONCRETE

Specialty transit systems have provided a significant array of design concepts which are suitable for urban sites. The Guideway for the Ford Fairlane system in Dearborn, Michigan used a very shallow guideway. This .66 meter deep 3.6 meter wide structure spans 18.3 meters. The construction was similar to the Disney monorail except that the forms were designed to flex vertically with adjustable side walls. Beams were post-tensioned together to provide a continuous structure. The low profile provides improved aesthetics while the width of the guideway offers some protection for pedestrians during inclement weather.

The Airtrans guideway at the Dallas/Fort Worth Airport in Texas uses a straight box section with a curved top flange. This, the Miami Downtown Peoplemover in Miami Florida and the Metropolitan Zoo in Toronto, Ontario, Canada all took advantage of straight casting beds to produce economical sections. The curvature was provided by only changing the alignment of the top flange, figure 6.

Adding to the guideway economy of straight casting was the use of conventional reinforcement to provide negative moment capacity. A second placement concrete topping on the Toronto Zoo guideway further separated the plant construction

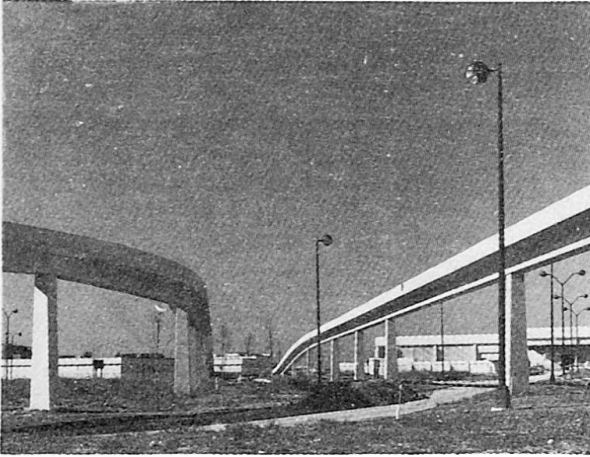

Fig 6. Straight stems and curved decks offer economy during construction at the Dallas/Fort Worth Airport.

tolerances from the field installation requirements.

A transit alternative developed by the Ministry of Transportation in Ontario, Canada uses a central spine beam and cantilevered side structure [10]. The central spine becomes not only the main structural support, but also the emergency walkway. Cross members supporting the rail are open to allow snow and debris from collecting in the structure.

#### 6. ADVANCED STATE-OF-THE-ART GUIDEWAYS

New transit technologies based on magnetic levitation propulsion are being developed in Germany and Japan. The guideways for these installations require the integration of all the design and construction technology to construct cost effective structures. The high operating speeds of these vehicles and the very tight magnet tolerances are primary design parameters. The MBB test track at Emsland, Germany is typical of the design issues [11]. The attractive magnets have very close tolerances for the placement of the supporting rails to assure motor efficiency and control stability. Dynamic amplification of the structure due to passing trains increases the tolerance requirements and creates high impact loads on the columns and substructure. Even with these constraints, reasonable sized guideways are constructed.

Japan Rail's magnetic levitation train uses repulsive magnets to support the train. Efficient magnet use limits the amount of magnetic materials available in the guideway. Consequently, Japan Rail is conducting a research program to qualify non-metallic prestressing and reinforcing materials for concrete guideways.

#### 7. CONCLUSIONS

Transit system guideways have the characteristic of well defined loads, high number of load cycles, and unique interface requirements. Guideway design offers an opportunity to merge design innovation, construction techniques and urban integration. The characteristic features of a transit structures apply to both steel rail supported systems and for specialty transit applications. The guideway designer should be cognizant of the potential for innovation and cooperation with the construction industry. Working as an integral part of the system engineering effort, the structural engineer is a primary position to affect the total cost of the installed transit system. Computer assisted design and construction provide substantial cost advantages. Aesthetically acceptable, cost effective, innovative structures can enhance both the urban setting and the attractiveness of the transit system.

#### REFERENCES

1. The Evolution of Transit Technology. Lea Transit Compendium, Vol. II, No. 1, 1975.
2. MAST, R.F. and DOLAN C.W., Walt Disney World Monorail, Designed for Smooth Riding. Civil Engineering, March 1971.
3. Urban Monorail System. Hitachi, Ltd., Tokyo, Japan.
4. BART: A lesson for other Transit Builders. Engineering New Record, Sept 26, 1974, pg 17.
5. 2266 Girders Required to Date for San Francisco Bay Area Rapid Transit Aerial Structure. Technical Bulletin, Stressteel Corporation, Bulletin No. 25, Wilkes Barre, PA, July 1967.



6. COHEN, S., BART Makes Tracks to the Future. Consulting Engineer, January 1972, pages 64-78.
7. DOLAN, C.W. and HUMMER, G.W., Concrete Shapes the Route. Concrete International: Design and Construction, February, 1984, pages 64-69.
8. MARTA'S Precast Segmental Bridges - a first for U.S. Transit. Railway Track and Structures, October, 1983.
9. AIRTRANS - Automated Transit System Design Summary. LTV Aerospace Corporation, Dallas, TX, 1978.
10. DORTON, R.A., GROUNI, H.N., and BILLING, J.R., Elevated Guideway Concepts for Light Rail Transit. Ministry of Transportation and Communications, Toronto, Ontario, 1976.
11. LÖNNECKE, K.H., and STÜBEN, H.H., Bauausführung des Betonfahrweges der Transrapid Versuchsanlage Emsland - TVE. Bauingenieur, vol 58, 1983, pages 129-134

Leere Seite  
Blank page  
Page vide

## **Metro of Monterrey, Mexico**

Méto de Monterrey, Mexique

Die Metro von Monterrey, Mexico

**Paul MONDORF**  
Senior Bridge Eng.  
J. Muller Int.  
San Diego, CA, USA



Paul Mondorf graduated from the Technical University of Denmark in 1953 with a masters degree in civil engineering. For the past 35 years he has been involved in the design engineering and construction of concrete buildings and bridges throughout the world.

### **SUMMARY**

In January 1987, the State of Nuevo Leon, Mexico, decided to build the first line of an elevated light rail system for the town of Monterrey. The guideway consists of an 18.7 kilometer long precast segmental concrete box girder. The project includes 619 spans with an average length of 27 meters. The design and construction of this elevated guideway were completed in two and a half years.

### **RÉSUMÉ**

En janvier 1987, l'Etat du Nouveau Leon au Mexique décida de construire la première ligne d'un méto aérien pour la ville de Monterrey. Cette structure ferroviaire, constituée par un caisson en béton à voussoirs préfabriqués, s'étend sur 18,7 kilomètres. Le projet comprend 619 travées de 27 mètres de longueur moyenne. Les études et la construction de cet ouvrage ferroviaire ont été complétées en deux ans et demi.

### **ZUSAMMENFASSUNG**

Im Januar 1987 entschloss sich der Staat Nuevo León zum Bau der ersten Linie eines Hochbahntransportsystems in der Stadt Monterrey. Die 18.7 Kilometer lange Viaduktanlage umfasst Spannbetonbrücken über 619 Felder mit einer mittleren Spannweite von 27 Metern, die als Einzelkastenträger in Segmentbauweise hergestellt wurden. Entwurf und Errichtung des Hochbahnviaduktes benötigten nur zweieinhalb Jahre.





Monterrey is a rapidly growing industrial state capital of Northern Mexico, a hundred and fifty miles south of the United States/Mexican border.

Its present population is estimated at 3 1/2 million inhabitants; the city is quite widespread among the counterforts of the Sierra-Madre Mountains. Most residential areas are one-story family dwellings or generally not more than 4-5 story multi-family houses. The city has a good system of radial and belt roads for rapid vehicle traffic. However, the larger part of the population is totally dependant on public transport, mostly buses, which are noisy and polluting and already overloading the city center.

The construction of a mass transit system was proposed and underground as well as on the ground and aerial solutions were examined. Preference was given to a light rail system, placed on an overhead structure built within the existing street area, a solution which combines efficiency and economy.

In January, 1987, the STATE OF NUEVO LEON decided to build a first line, 18.7 km long, and in November of the same year a public utility called METRORREY was created to transform that decision into reality.

High construction speed was an absolute must. The construction time was initially set at some 24 months.

J. Muller International proposed a segmental bridge concept to the contractor Construmetro. This concept was selected for the following reasons:

- Quantity savings involved by using a single box girder carrying 2 tracks (11.5 T/axle cars).
- Versatility of the concept allowing for the same equipment (form and assembly truss) to build spans ranging from 15 to 47 meters, as required by the environmental constraints in this very dense urban area.
- Speed of erection.
- Construction of the stations using the typical viaduct box girder for its main supporting structural member.

## DESIGN FEATURES

The Metro line will be served by an electric train, each convoy comprising 2, 3, or 4 articulated vehicles, each one 30 meters long on three bogies. The vehicles have traditional wheels rolling on gauge rail track, using rails of 115 lbs/yd (57 kg/m), welded in lengths up to 2700 meters. The double track will be placed on plinths directly on the carrying bridge structure. The current, 1500 V direct, will be served by overhead catenaries, suspended from posts placed on the bridge deck alongside the track. Furthermore, on either side of the track, the bridge deck carries signal posts, cable ditches, maintenance cat-walk and concrete parapets.

Along the line stations will be placed approximately every 1100 meters. The line will have

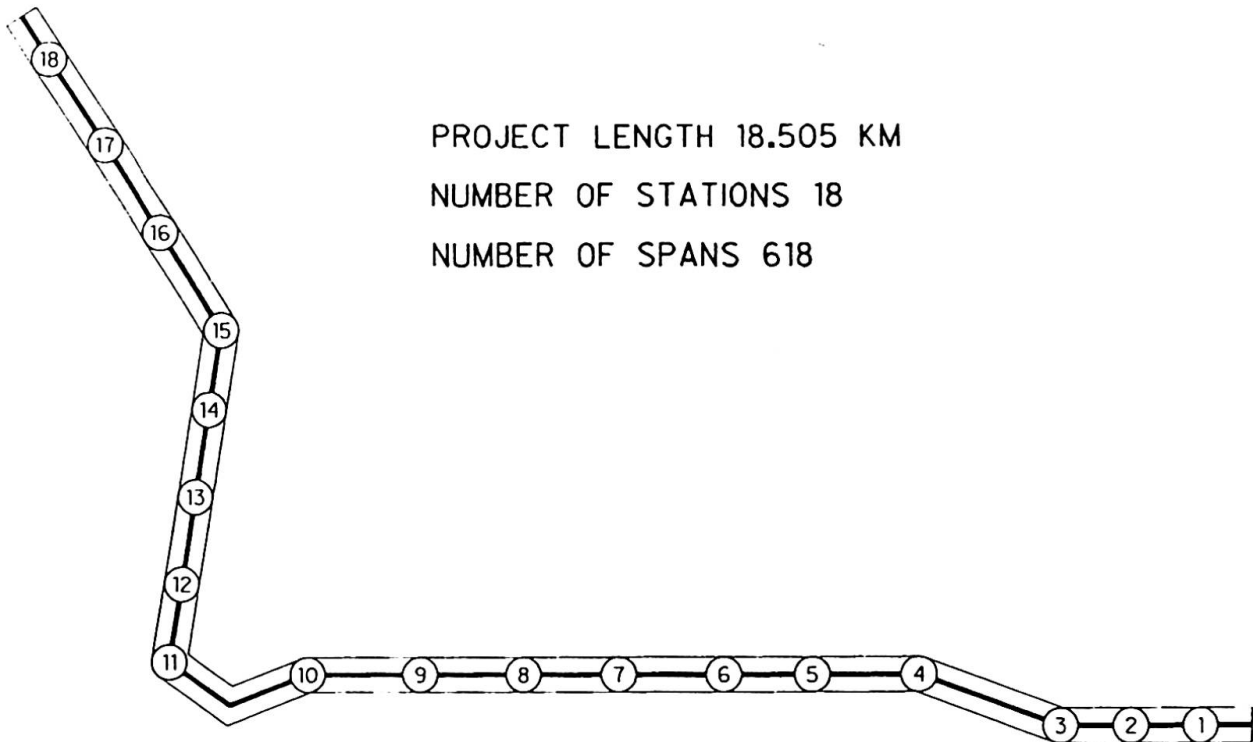

PROJECT LENGTH 18.505 KM  
NUMBER OF STATIONS 18  
NUMBER OF SPANS 618

GENERAL PLAN

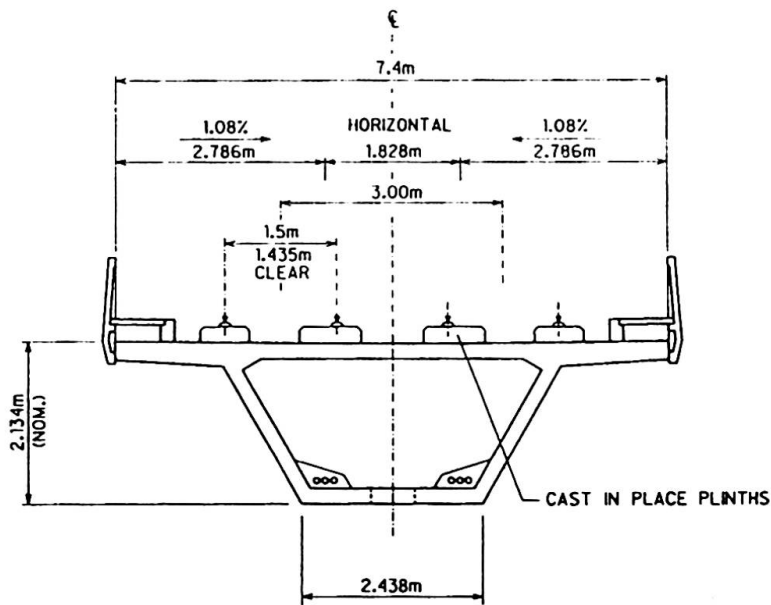

TYPICAL SECTION



13 cross-overs between tracks and two emergency turn-outs. The maintenance shops are placed at the end of the line, where a descent to ground level is provided.

The train has a design speed of 70 km/h. The weight of a vehicle is 40t dead load + 27t live load corresponding to some 400 passengers. The structure is designed for boogie loads of 24 and 20t respectively, spaced approximately 10 m cc, and a coefficient of impact of 0.2. In passenger areas a uniformly distributed live load of 500kg/m<sup>2</sup> has been taken into account. Derailment load has been considered according to the Sacramento Light Rail Project, Design Criteria 1982, Chapter 7.

The bridge structure has been designed according to AASHTO Standard Specifications.

The width of the bridge deck will be 7.40 meters on straight line increasing to 7.85 meters in sharp curves.

Horizontal curves have a radius of not less than 250 meters and the corresponding superelevation of the rails is achieved through over-height of the plinths. The longitudinal slope of the line generally does not exceed 2%, but in special zones up to 3.5% is accepted. Vertical curves have a minimum radius of 2000 meters.

### THE BRIDGE STRUCTURE

The basic structure has raft of bored pile foundations, single columns 5-15 meters high with massive shafts and flared out capitals, and a bridge deck formed as a single box girder, which carries the plinths for the rails.

The major part of the structure was conceived as simply supported spans with span lengths from 15 to 36 meters; the average span has a length of 27 meters. The span lengths were determined mainly by the conditions at street level for the placement of footings and columns.

Moreover, the structure comprises 4 groups of continuous spans 30-47-30 meters long, fitted to solve the crossings of particularly wide avenues.

In certain areas, due to restrictions at ground level or for traffic reasons, the single columns have had to be replaced by straddle bents, each one composed by two columns, placed, for example, at either side of the street, and an overlying post-tensioned concrete girder of double-I-cross section to carry the bridge deck.

The box girder cross section is held constant through-out the bridge, it has a depth of 2.13 m (7 ft), inclined webs 0.305 m (1 ft) thick, a 7.40 m (24 ft, 23in) wide top slab, cantilevered out along both sides of the basic box and a 2.438 m (8 ft) wide bottom slab. Top and bottom slab have a thickness of 0.203 m (8 in). At both ends of a simply supported span and over all intermediate piers of continuous spans, heavy diaphragms are provided.

The box girders are all precast segmental requiring basically two different types of segments, namely typical segments up to 3 meters long, and pier segments 1.5 or 1.2 meters long, in slightly different versions for simply supported and continuous spans respectively.

The box girder is post-tensioned longitudinally by tendons anchored in the diaphragms. Over the major part of their lengths, the tendons are running outside the concrete, but



SIMPLY SUPPORTED SPANS

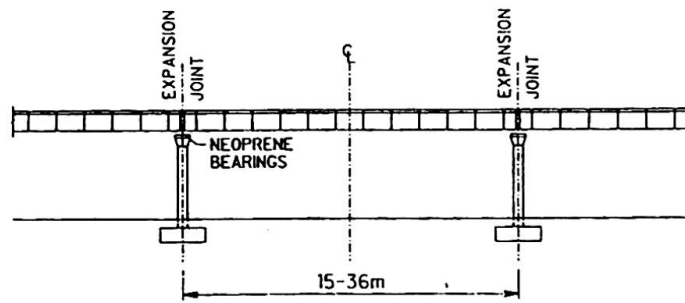

CONTINUOUS SPANS

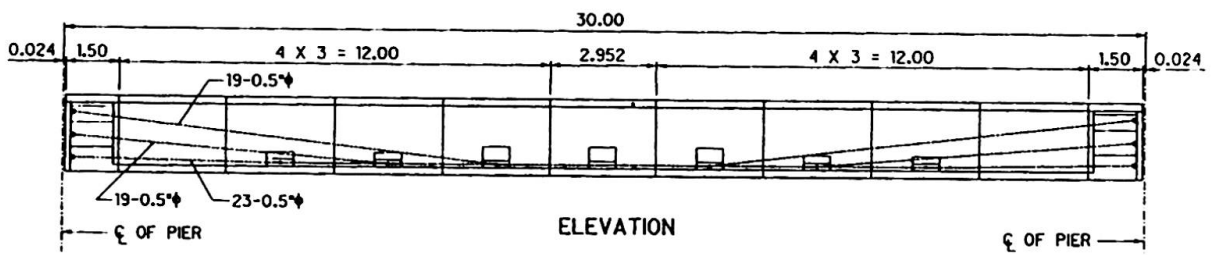
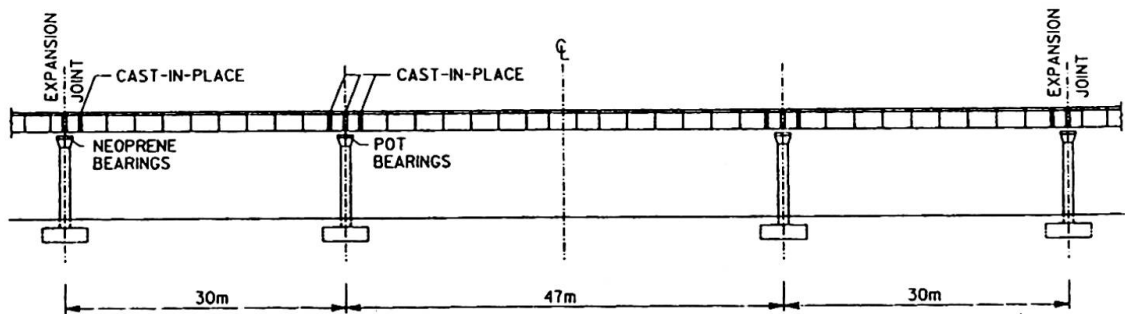

PLAN

TYPICAL PLAN POST-TENSIONING LAYOUT



inside the box girder, lodged in PE-tubing. The tendons are deviated at specific locations through steel pipes embedded in concrete deviation blocks, cast monolithically with the box segments.

The top slab of the box girder is pre-tensioned transversely and the segments are reinforced with passive reinforcement at an average rate of 120 kg/m<sup>3</sup> for typical segments, 160 kg/m<sup>3</sup> for pier segments. The concrete design strength is 350 kg/cm<sup>2</sup>.

The box girder was conceived for match cast dry joints with keys provided on all matching surfaces.

The bridge structure also includes 18 metro stations, each one basically composed by a 30 m long central hall, built as a combination of precast and cast-in-situ concrete column/girder/slab structure and on both sides of the central hall a 45 meter long platform area, built as continuous two or three-span segmental bridges of the same cross section as the rest of the bridge, but equipped with brackets to support precast cross beams which will carry the cantilever passenger platforms.

The structure comprises a total of 619 segmental spans requiring some 6503 segments, namely 5265 typical ones and 1238 pier segments.

### PRECASTING

In order to manufacture the great number of precast elements required by the project a precasting plant was installed in a 16 ha large area some 20 km north of Monterrey.

In Monterrey the long-bench method was selected for simplicity of execution and for its good economy as a high number of reuses of the benches could be anticipated.

The twenty long benches were made in reinforced concrete. They have lengths from 39 to 53 meters in order to allow for the casting of all types of spans in full length.

The plant was equipped with 26 moulds for typical segments and 14 moulds for pier segments. The moulds for the segments each consist of two lateral forms fixed on trolleys, a central core also fixed on a trolley, and one or two bulkheads. All trolleys have wheel blocks equipped with adjustment screws. The trolleys move on rails cast into the lower parts of the long bench, whereas the segments themselves are cast directly on the raised central part of the bench. The lateral forms can be fitted against the raised part of the bench and kept in place by the tie rods passing through that part of the bench.

### ERECTION

The segments are transported by road on low-boys from the precasting plant to the erection sites where they are erected using the span-by-span method.

Following this method the segments for one span are placed on erection girders, adjusted into position so that matching keys will fit perfectly, and stressed together by post-tensioning tendons whereby the span becomes self supporting. The weight of the span is then transferred to the permanent bridge bearings whereafter the trusses are separated from the span and shifted forward in order to serve for the erection of the following span.





The erection girders are modular steel trusses of triangular cross section fitting one under each wing of the segments. The length of the trusses is adjustable from some 24 to 49 meters in order to allow for the erection of spans of all lengths.

The trusses are supported on steel brackets which are suspended from the capitals of the bridge piers and clamped around the pier shafts.

For spans of 36 meters or more, intermediate supports are required; these are provided as modular steel towers which can be installed directly on the pavement.

The trusses, the pier brackets and the intermediate towers have a large number of special features permitting them to accommodate all span lengths and all pier configurations, such as square and skew piers, straddle bents at one or both ends of the spans, spans in curve and continuous spans in the platform areas of the stations.

The erection of a typical span generally takes 2-3 days, but before the erection of the span can be considered complete various finishing operations have to be carried out, preferably in the two-three spans following behind the one being erected. These operations include grouting of tendons, installation of hold-down rods, and possibly some concrete repairs, filling of block-outs, etc.

#### KEY DATES

Detailed Structural Design, Start	January 1988
Acquisition of the Ground for the Precasting Plant	July 1988
First Segment Cast	October 1988
Erection of First Span	March 1989
End - Precasting of Segments	April 1990
End - Erection of Spans	July 1990

#### J. MULLER'S SCOPE OF WORK

- Detailed Design of Bridge Superstructures
- Detailed Design of Segments Forms and Erection Trusses
- Technical Assistance to Contractor On Site

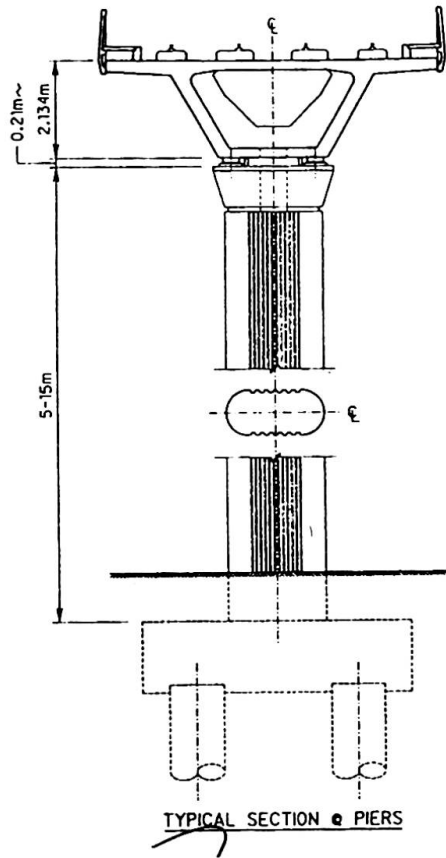

STATIONS:

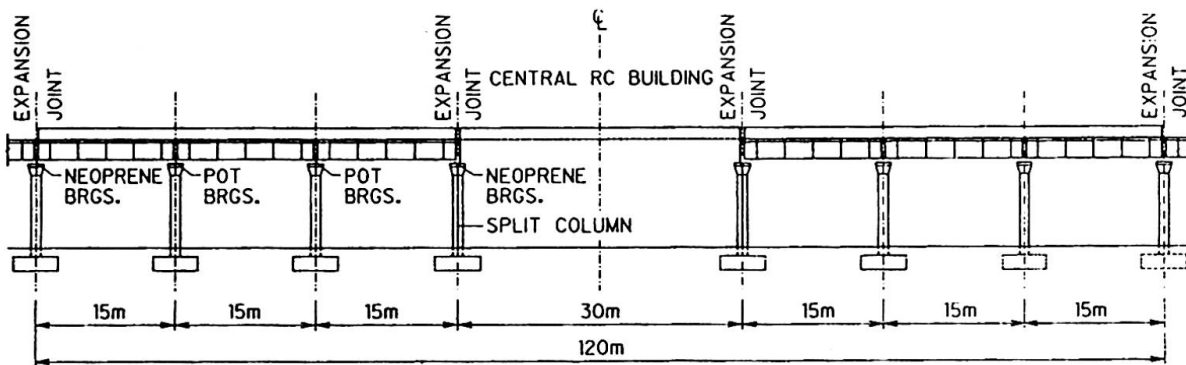
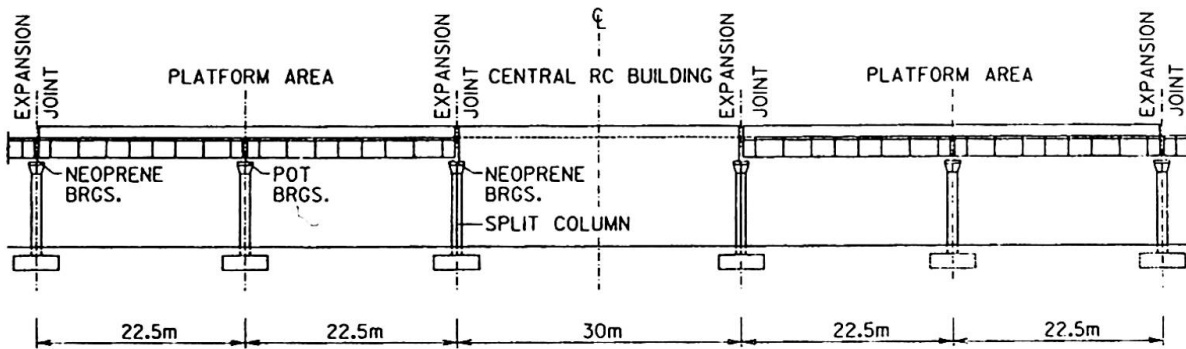

ELEVATION STATIONS





Leere Seite  
Blank page  
Page vide

## O-Bahn, a Dual Mode Urban Transport System

Système de transport urbain "O-Bahn"

Nahverkehrssystem O-Bahn

### **Karl Heinz BOEKELER**

Prof. Dr.  
Ed. Züblin AG  
Stuttgart, Germany



Karl Heinz Bökelér, born in 1941, received his engineering degree at the University of Stuttgart. He is director and head of the department of Construction Engineering of Ed. Züblin AG. He is part-time professor at the University of Stuttgart.

### **SUMMARY**

The public transport system O-Bahn, based on bus technology, can be started with buses on public roads and can be extended to the high-capacity vehicle train on separate tracks. The uniform design of vehicles of different sizes and largely standardised track components permit the extension of the transport by stages in accordance with traffic requirements and financial situation.

### **RÉSUMÉ**

Le système "O-Bahn" de transport public est fondé sur la technologie de l'autobus. Ce moyen de transport est flexible et compatible. Il peut ainsi être exploité sur la route ou sur des voies séparées, comme un moyen de transport ferroviaire. La conception uniforme des véhicules de différents gabarits et la standardisation des éléments de voie permet une extension du réseau par étapes, en fonction de la situation financière et des données de la circulation.

### **ZUSAMMENFASSUNG**

Das Nahverkehrssystem O-Bahn ist auf Bustechnologie aufgebaut. Kompatibel und flexibel kann die O-Bahn, beginnend mit Busverkehr auf öffentlichen Straßen, bis zum Zugverkehr auf separaten Strecken ausgebaut werden. Der einheitliche Entwurf der Fahrzeuge in unterschiedlichen Größen und standardisierte Fahrweegelemente erlauben einen stufenweisen Ausbau je nach finanziellen Gegebenheiten und verkehrlichen Vorgaben.



## 1. O-BARN CONCEPT

Bus operation offers a highly economical solution for urban transport as a result of a low level of infrastructural requirements and also low investment and maintenance for the bus fleet. The relatively low infrastructure costs for bus transport mainly result from the fact that buses can travel on public roads.

Traffic density, however, is a problem in all major cities throughout the world and has a detrimental effect on bus transport capacity and travelling convenience. For this reason an exclusive right of way for buses has been demanded from many transport authorities.

The improvement attained with bus lanes, marked by white lines, is not as considerable as with separate railway tracks with an exclusive right of way over the whole length of the track because there are interruptions at all road intersections. For this reason separate tracks in separate corridors for buses, too, constitute an increasingly urgent requirement.

It is an advantage in the case of separate tracks if the buses are track-guided just like a rail car, because this makes it possible to save space and costs.

Still, infrastructure costs can be kept at a relatively low level because the tracks need to be built only in areas where the extremely tight traffic density necessitates such a construction; in other areas buses can continue to use normal roads.

## 2. O-BAHN COMPONENTS

### 2.1 Benefit of guidance systems

From its principle, a track-guided system requires a more narrow track width than in the case for hand-steered vehicles. The road width for manually steered vehicles must be much larger than the width of the vehicles body itself to take the human factor into account.

For track-guided systems the vehicle clearance profile must be only a few centimetres larger than the vehicles contour - independent of the vehicle's speed.

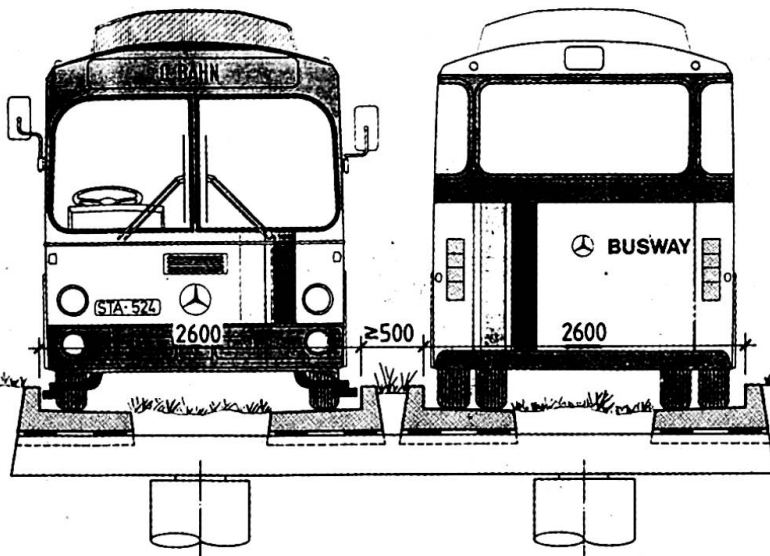

Fig. 1 Cross section of double lane

The very low lateral movement of guided vehicles allows to design the guideway itself from two running strips only the width of the vehicled tires. The remaining surface of the corridor, this means more than 50 %, can be grass land area. This guideway design leads to a higher acceptance and offers improved possibilities for easier



integration of public transit corridors in sensitive city areas (Fig. 1).

Another positive effect of this design is the lower emission of the running noise on the environment. The reduction related to noise emission of a bus running on roads is approximately 6 dBA because of the lateral protection of the tires.

The mechanical guidance system chosen for the O-Bahn makes it almost absolutely impossible - even under slippery road conditions - that the vehicle can leave the guideway. This means that safety is independent of human factors and weather conditions, and in this relation it is much higher than in manually steered operations.

With track-guided systems the riding comfort is independent of the drivers action. High riding comfort is consistently ensured by high production quality and alignment accuracy of the guiding elements during a long service period. The riding comfort is comparable with well-developed rail systems.

An additional comfort effect is that guided buses can stop very exactly with a small gap at the platforms thus rendering the boarding and alighting of the vehicle very comfortable for the passengers.

The guiderails themselves and the guideway design, in general, protect the public transit corridor against misuse and prevent car drivers from trying to cross or drive along the guideway.

Finally, if necessary in a very high stage of development guided operations offer the possibility to form trains and make the transmission of electrical energy to the vehicles more reliable.

## 2.2 Track guided system for O-Bahn vehicles

### 2.2.1 Requirements, technical solutions

Wheel and rail form a simple and - up to the highest travelling speeds - very safe carrying and guidance system. However, attempts to apply this to vehicles which can be used in hand-steered operation on the road and in guided operation on tracks of their own, and where quick transition from one operation mode to the other must be ensured, have not yet led to satisfactory results.

For a mechanical guidance system with a guiding trough formed between the lateral guide rails it is easy to provide reliable guidance independent of slippery roads caused by unfavourable weather conditions.

Even with slipping road wheels, the guide rails function as an emergency guidance system, reliably preventing the vehicle from braking away from the guideway. Normally the front wheels are always steered by the guide rails via guide wheels and guide arms in such a way that the vehicle follows the centre line of the trough with only slight deviation due to minor disturbances.

### 2.2.2 Guideway construction methods, alignment methods

An uneven surface of the guide rails is the main source generating the lateral movements of the vehicle on the track. This means that the accuracy of the track guidance determines the riding comfort and has an important influence on the vehicles clearance profile and, finally, on the track costs, too.



These considerations resulted in establishing construction tolerances of millimetres for the guide device of mechanical track guidance. By means of prefabricated concrete components it has been possible to comply with the required narrow tolerances.

The production of the prefabricated components in a factory on site ensures the greatest possible evenness of the guide rail surfaces over the entire length (12 m) of the prefabricated component.

Efficient routing of the prefabricated components with the highest possible degree of accuracy, that is to say end offsets in the range of millimetres and very small angular deviations at reasonable cost had to be developed and can be managed today. The use of prefabricated components means that transition curves have to be constructed from arc elements whose radii increase or decrease within the course of the curve (so-called oval or basket arches), because - for reasons of cost - only a limited number of formworks can be manufactured for different radii.

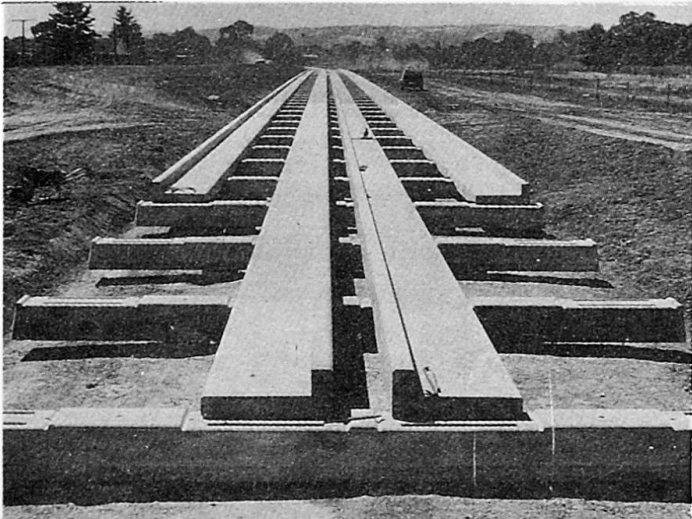

Fig. 2 Prefabricated components

The running strips of the guideway (with integrated guide rails) are carried by sleepers being prefabricated in factories as well (Fig. 2). The foundation of the track depends on the soil conditions. Either flat foundation or, if necessary, pile foundation is possible.

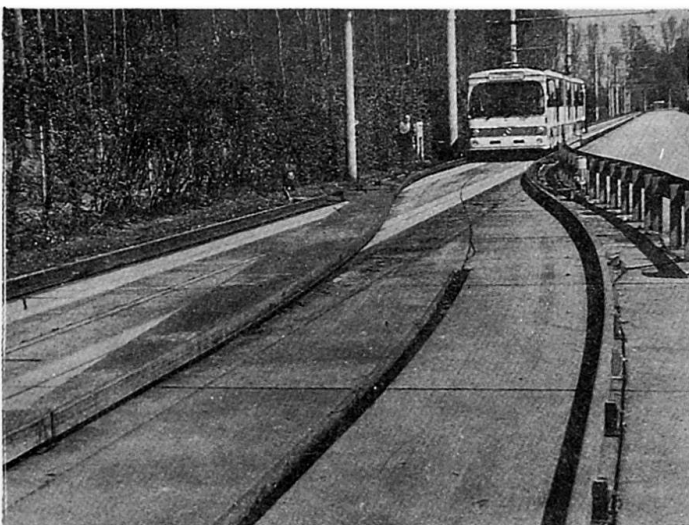

Fig. 3 Switch

If only plan profile prefabricated components are used, i.e. those which are not twisted, the construction costs are positively influenced and the upslopes and downslopes of the super-elevations can still be constructed by inclining the entire guideway component by component. To achieve good ride comfort, these boundary conditions require careful matching of changes in radii and degrees of superelevation.

In order to maintain the accuracy of the guideway the height of the sleepers on the foundation can be adjusted.

### 2.2.3 Special guideway components

#### Junctions, entry areas

Switches have been developed to take all conceivable requirements into account, especially those relating to train operation (Fig. 3).

Various construction forms with alternative lowering of guide rails for branching-



off and straight-on tracks as well as with swing-type or bending guide rail sections which are especially suited for combination with rail switches were installed as prototypes and tested up to operation standards.

However, they have so far not been used in facilities built for practical operation. On these tracks, the buses are steered manually through junction areas, which on the one hand saves high costs and on the other hand achieves high operational flexibility and particularly short intervals between vehicles.

Design of the entry areas into the track-guided section behind the junction areas (and not only there) is based on aspects of driving dynamics and thus permits the driver to enter the track-guided section at a speed of 40 km/h (or more). Since the speed must be reduced anyway in most junction areas (stations, curve radii, visibility), the limited entry speed specified by the operating instructions does not represent an obstruction of the operations.

#### Extraction of exhaust gases

Central importance is attached to diesel operation in the O-Bahn concept because of the low system cost and considerable operating economy of diesel-powered buses. Direct extraction of exhaust gases has been developed as part of the upgrading concept to enable track-guided diesel buses to operate also in lengthy tunnelled sections with station (Fig. 4).

This allows the following system requirements to be fulfilled in a practical manner:



Fig. 4 Extraction of exhaust gases

- no operational restrictions in respect of speed and system change
- practically no bad-smelling fumes in underground stations
- low energy consumption and
- possibility of central, catalytic treatment of exhaust gases.

System testing commenced in 1986 in a disused railway tunnel at Wertheim in Germany. The tests aimed at determining the operational design data have meanwhile been concluded.

### 2.3 Vehicle family

The O-Bahn system represents a family of vehicles, ranging from the standard regular service bus through the articulated bus to the double articulated vehicle. The double articulated vehicles can be operated on arterial roads and on guideways whereby the formation of trains is possible. In this way, transport volumes can be achieved which could never be managed in conventional bus transport. These vehicles can be equipped with diesel or electric drive system.

A duo bus is realised with a double drive with full operational efficiency, namely diesel engine and automatic transmission on the



one hand and electric drive on the other hand. The duo bus is characterised by

- the same comfort characteristics as in the standard regular service bus, such as low and even vehicle floor, easy entry, broad aisle,
- the same passenger capacity (with corresponding number of seats) as in the diesel-powered articulated bus,
- and general availability due to independent drive systems.

In the future, the electrical components will be used as standard, on all electrically powered O-Bahn vehicles to achieve production economies from longer production runs and, in this way, to diminish the cost disadvantages of electric drive compared with diesel drive.

The aim of vehicle development is to achieve lower specific purchase costs and lower specific vehicle weights in comparison with conventional rail vehicles by basing vehicles on modern bus technology.

Lightweight design permits energy savings, notably with the close station spacing which is predominant in local passenger services.

### 3. GENERAL TRANSPORT CONCEPT OF O-BAHN

#### 3.1 Stages of extension

The basis of the transport concept is the operation of buses as normal road users. Bus transportations offer two advantages in the attractivity for the passengers. These advantages are short walkways to and from the stops as well as a low number of transfers in the route network. Bus transportation on public roads is a very economic solution and thus another advantage for the authority.

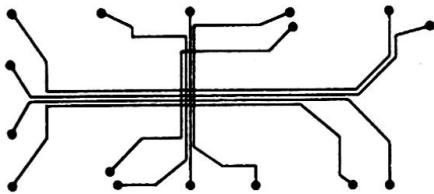

Existing line network

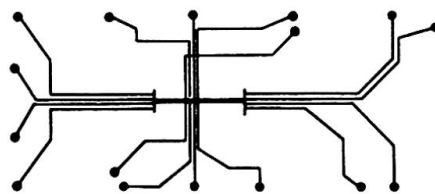

Expansion-first stage

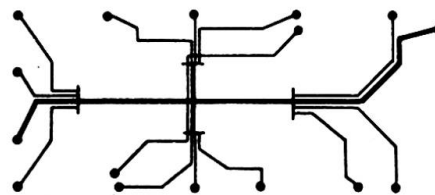

Expansion-second stage

Bus transportation can be improved by constructing a guideway on certain route sections as the own right of way for buses. These measures are introduced in stages, in most cases with an immediate service benefit. Sections of route, for example, in city centres which have developed historically, can be constructed in tunnels, or, as in Adelaide lengthy at - grade sections can be established within a given corridor (Fig. 5).

For some years this stage of development of O-Bahn, called Guided Bus, has been realised in the cities of Essen and Adelaide and in revenue service in both towns.

Should, in other applications, future traffic volumes necessitate the implementation of a guideway over the full length of the route, this can likewise be implemented in stages, with the final

**Fig. 5** Step from bus system to O-Bahn system

stage permitting the operation of large-capacity O-Bahn vehicles allowing train formation over a throughroute. In this development stage, too, full compatibility is assured between dual-mode operation and operation of vehicle trains over shared sections of routes.

The O-Bahn concept is thus based on the objective of implementing a transport network according to traffic volume, structure and investment capital available, by using largely standardised system components developed from, or adapted to, bus technology and combining the lowest possible costs with the maximum possible benefits.

### 3.2 System Upgrading

This objective of the O-Bahn concept requires that the system components have to permit practical system upgrading. Upgrading has to be achieved in three system sectors:

- vehicles including traction system
- guideway
- operation

Different vehicle sizes offer possibilities for an upgrading of the passenger capacity. The transition from diesel operation to electric traction or a combination of both operation methods complies much better with the requirements of higher environmental quality, especially in the city areas. The extension of the guideway network results in a higher attractiveness for the users of the system and also in a higher passenger carrying capacity owing to the faster travelling speed and the shorter round trip time of the vehicles.

If required by the passenger volume, for example, a proven method is to operate a larger number of vehicles in so-called platoons. In addition to the same and as an alternative multiple off-line stations - as used in Adelaide - result in an upgrading of the passenger capacity.

## 4. GUIDED-BUS OPERATION IN ADELAIDE AND ESSEN

### 4.1 Adelaide (South Australia)



Fig. 6 O-Bahn Adelaide

In Adelaide eleven bus lines are operated with a vehicle fleet of 100 buses over a 12 km guideway between the north-eastern suburbs and the city centre. The maximum speed on open stretches is 100 km/h (Fig. 6).

Since the start of scheduled services in March 1986, the buses have covered a total of approx. 21 million kilometres, and 8 million of them were covered in track-guided operation. A

total of approximately 25 million passengers were transported during the first five years of operation.





In contrast to a light-rail system, the passengers do not have to change frequently since the same buses are steered manually through the suburbs to collect the passengers and then transport them quickly to the city via the guideway.

The buses are hand-steered, too, in the area of the two intermediate stations; this allows mutual overtaking and the highest possible flexibility in operation. No signal system is incorporated. The vehicles are controlled only by the visual assessment of the driver.

In practice, extraordinarily short vehicle sequence times of 30 s are possible. In conjunction with short trip times and high vehicle speeds they add to the attractiveness and capacity of the system.

The system is very well accepted by the users. After putting the system into service the passenger volume has increased by slightly more than 35 %.

As far as the costs of the system including the vehicles are concerned, 40 % in investment was saved as compared with a light-rail system.

A comparison of the operational costs for 1986/1987 between the commuter rail systems operated by the authority of Adelaide, too, and the O-Bahn (guided bus system) results in a cost relation from approximately one to two as a cost advantage for the O-Bahn.

#### 4.2 Essen (Germany)

As early as 1980 the first bus guideway was put into service in Essen (Fig. 7). The network has been extended gradually and in 1988 the highest extension level had been reached by taking into service the mixed-operation stretch for guided duo buses and trains in a tunnel.

On this mixed-operation stretch the duo buses are powered by an electric motor; they are also included in the light-rail protection system installed in the tunnel. This means that they have to be monitored by the protection system, and in case the drivers do not observe stop signals or exceed the maximum speed, they are automatically braked.

This required the development of absolutely reliable identification devices for tyred vehicles which cannot provide a track



Fig. 7 O-Bahn Essen

position indication by electric contact between the steel wheel and rail as in the case of normal trains.

A prolongation of this tunnel with a length of 2.5 km including three stations is approaching completion and will be put into practical operation in autumn 1991.

The guideways at ground level in Essen are all constructed on former separate tramway tracks, one to the suburb Kray with a length



of 4 km with three stations and one to the suburb Haarzopf with a length of 2 km with three stations. Outside these corridors and outside the tunnel the guided buses are running on the public roads manually steered.

The guided busroutes to the suburbs have replaced the former tramway lines for reasons of economy. The operational experiences with the guided buses in Essen are basically very positive. The maintenance work for the guiding device on the vehicles is acceptably low. The amount for guideway maintenance needed over a period of more than 10 years is negligible.

For the handling of the track cleaning winter service, a guided special service vehicle was designed, manufactured and delivered to Essen and is well proven in operation.

A total of 60 buses - 18 of which are equipped with a duo drive - are operated on the guideway stretches which are currently 7 km long, 9.5 km from autumn 1991.

The vehicles in Essen have meanwhile covered a total of 20 million kilometres, 4 million of them in track-guided operation. The number of passengers now amounts to approximately 40 million.

An interview action of the passengers just being carried out has demonstrated the high acceptance of the guided bus system in Essen.

## 5. SUMMARY

A public transport system has been developed which can be extended in stages up to the formation of trains operation on separate guideway. The track guidance systems are essential components of the O-Bahn transport system. In addition to reducing the width required for the bus-only routes, the operational compatibility of the mechanical track guidance versions, in particular, enables supplementary system components to be developed to permit bus services to be upgraded in stages in line with requirements to create an efficient total O-Bahn transport system.

Leere Seite  
Blank page  
Page vide

## Use of Precast Elements in the Construction of Delhi Flyovers

Eléments préfabriqués pour passages supérieurs à Delhi

Fertigteileinsatz bei Überführungen in Delhi

**S.S. CHAKRABORTY**  
Managing Director  
Consult. Eng. Services  
New Delhi, India



S S Chakraborty, born in 1937, got his Civil Engineering degree from the University of Calcutta, India. For the last 32 years he was involved in different capacities in various bridge/flyover projects in India and abroad.

**B.C. ROY**  
Associate  
Consult. Eng. Services  
New Delhi, India



B C Roy, born in 1944, received his Master's Degree in Structural Engineering from IIT, Kanpur, India. Being an Associate of Consulting Engineering Services, he is responsible for the design of flyover/bridges and industrial structures.

### SUMMARY

The Delhi Tourism and Transportation Development Corporation, with a view to relieving the traffic congestion in the capital, has initiated a comprehensive transportation scheme entailing the construction of about twenty flyovers over the major corridors. An integrated systems approach was used in evolving the details of the flyovers and the resulting system uses precast elements extensively. It was also found that centralizing the precast factory is more economical than having one at every site. This paper presents the elements of the systems approach and also brief details of the central precast factory.

### RÉSUMÉ

En vue de résoudre l'engorgement du trafic routier de la capitale, la Société des transports et du tourisme de Delhi a initié un plan global de transport, imposant la construction de plus de vingt passages supérieurs sur les axes de circulation les plus importants. Une étude intégrale des systèmes possibles a conduit à devoir utiliser les éléments préfabriqués pour la plupart de ces ouvrages. Cette analyse a également montré que la centralisation de la préfabrication dans une fabrique unique était plus rentable que la dispersion dans de multiples chantiers. L'article présente des éléments de l'étude des systèmes de construction ainsi que certains détails de la centrale de préfabrication.

### ZUSAMMENFASSUNG

Als Abhilfe gegen die Verkehrsstaus in Delhi hat die Tourismus- und Verkehrsbehörde der Hauptstadt den Bau von etwa 20 Überführungen über die Hauptverkehrsachsen initiiert. Eine integrale Systemanalyse zur Erarbeitung der Konstruktionsdetails führte zur ausgedehnten Verwendung von Fertigteilen. Ebenso ahellte die höhere Wirtschaftlichkeit einer zentralen Fertigteilfabrik gegenüber Feldfabriken. Der Beitrag stellte Elemente der Systemanalyse und Einzelheiten der Fertigteilfabrik vor.



## 1. INTRODUCTION

Like most of the metropolitan cities in the world, there has been in recent years an alarming growth in the vehicular population in the capital city of Delhi, resulting in heavy traffic congestion and high level of pollution due to the near crawling speed. In order to address this problem the Delhi Tourism and Transportation Development Corporation has initiated a comprehensive transportation scheme which includes inter-alia construction of about twenty flyovers over the major corridors of the capital.

The essential constraints are the speed and the ease of construction, minimum impedance to the existing traffic flow during construction without sacrificing overall economy and the aesthetics. In order to achieve the time-bound target, an integrated approach has been adopted right from the planning, designing and implementation. Moreover, respecting the site specific problems and conditions, system approach has been conceived with standardised design and construction.

This paper describes the system adopted for the successful implementation of the time-bound programme.

## 2. CONSTRUCTION METHODOLOGY, GEOMETRIC ARRANGEMENT AND SUPERSTRUCTURE SYSTEM

### 2.1 Construction Methodology

Since most of the corridors and the intersections are heavily loaded and offer very little scope for elaborate traffic diversion, adoption of precast elements for suspended structures is a natural choice. Use of precast elements will also expedite the construction process. A central precast factory presents itself as an obvious choice over separate units at or near each site for the following reasons:

- reduced requirement of constructional plant and equipment as also working space at various sites
- better use of reusable resources such as shutterings etc.
- better quality control and overall economy

Adoption of a central precast factory for various flyovers, some of them far removed from the factory site, create problems in transporting the precast elements through the congested corridors and these aspects have been given full consideration in evolving the system.

### 2.2 Geometry and the Structural System

After examining the various flyover locations, an arrangement with central spans to suit each flyover location and viaduct spans of about 18 m is considered to be optimal. The central spans are designed as box girders. These spans could be built in-situ or by using segmental construction using post-tensioned precast box elements. Since the latter method would need elaborate and costly equipments and arrangement at site, it has not been preferred.

For the viaduct portions, the various structural systems that were considered are single cell boxes for each 2 lane carriageway; voided deck system; girder and slab system; and closely spaced beam and slab arrangement. The various alternatives are shown in fig.1. The single cell boxes tend to be uneconomical for short spans and also pose almost insurmountable problems in transporting them using the existing handling infrastructure. The voided deck system negates some of these disadvantages

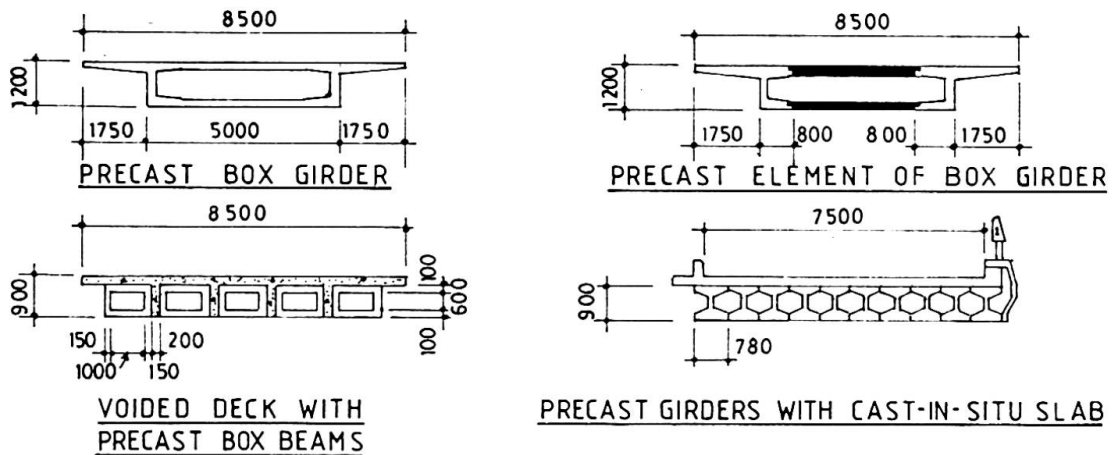

Fig.1 : The various alternatives for the viaduct spans

but needs extended construction site involvement in the form of left-in shutterings. Detailed analysis shows this system to be uneconomical. The girder and slab construction has also negative points within the context of the envisaged construction programme. The girders are too heavy to be transported. The system requires casting of a number of diaphragms and the system does not present an aesthetically pleasing appearance from the under side. These problems can be avoided in closely spaced beams and slab arrangement. The system is aesthetically pleasing, easy for transportation and erection, due to lighter weight of the beams, and is finally adopted for viaduct portions.

While finalising the arrangement the maximum length and weight of the beam which can be handled and transported from the factory to the site were considered. A girder of about 18 m length weighing between 14 to 15 tonnes was considered optimum. Fig.2 shows the adopted arrangement from the under side.

The proposed arrangement consists of a number of beams which are contiguously placed. The actual number of beams across the transverse direction depends on the width of the carriageway. For example, 10 beams are provided for a 7.5 m wide carriageway, 12 for a 9.0 m one and 14 for a 11.0 m one. The deck comprises a 150 mm thick RCC slab laid over the beams and connected by shear connectors embedded in the precast beams.

Depending upon the subsoil conditions at the various flyover locations, simply supported or continuous beams were adopted. Fig.3 shows the details over the support of a continuous beam. The beams are 17700 mm long, 780 mm wide, 900 mm deep and weigh 15 t, and were designed using standard procedures.

Specially designed fascia and railing have been used to improve aesthetic appearance, especially at supports.

### 3. CENTRAL PRECAST FACTORY

#### 3.1 General

A central precast factory was established to carry out the envisioned construction programme. The precast factory comprises the following elements arranged in such a way as to ensure a smooth flow of operations in a sequential manner:



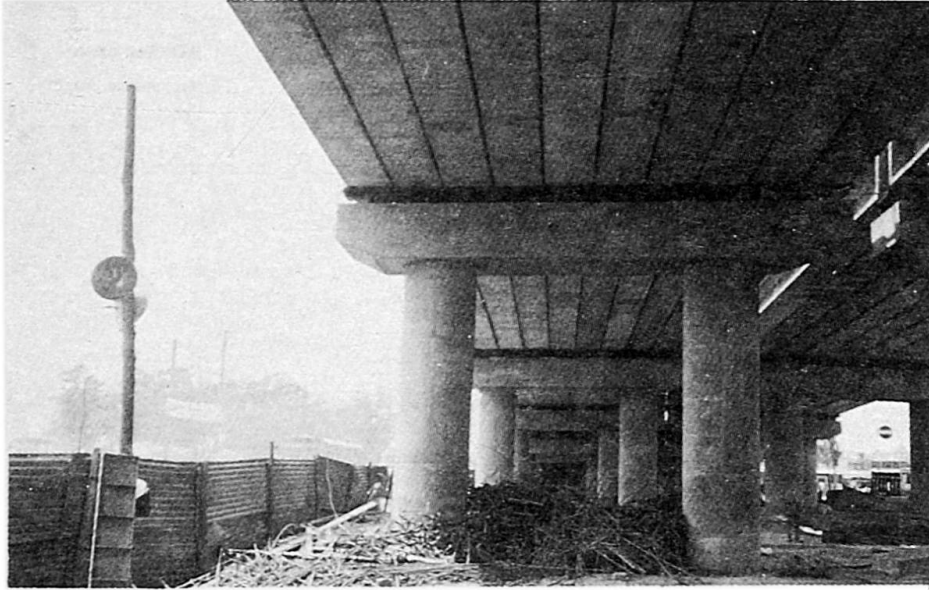

- automatic concrete batching plant
- wire stacking and reinforcement fabrication yard
- casting, stacking and loading yards
- facilities for steam curing
- testing facilities

### 3.2 Pretensioned and Precast beams - casting and stacking

The production capacity of the casting yard was 4 girders per day with a provision to augment it to 16 per day. Steam curing and long line method of pretensioning were adopted to increase the turnover of precast elements. Though steam curing entails additional initial outlay for steam production and distribution systems, it was offset by the increased production and the reduced number of bed forms required for the same output.

The reinforcement, assembled in the steel fabrication yard and moved to the casting yard on a trolley, are lifted by two mobile cranes of one tonne capacity and shifted into the moulds. This operation precedes the threading of prestressing strands.

The pretensioned girders, four in number, are cast in one operation in a special mould. All the strands of the girders in the line are stressed simultaneously in one operation. The prestressing force is sustained by steel bulk heads, one of which is movable. Steam curing is adopted and the details of the procedure are presented in section 3.3.

After steam curing the side shuttering is removed and the force in the prestressing jacks is released gradually. The ends of the prestressing strands are cut in accordance with the designed sequence. The girders are moved and stacked in the stacking yard. Fig.4 shows an overall view of the casting yard.

The stacking and loading yards abutting the casting yard are equipped with a 20 tonne capacity EOT crane for the purpose of moving, hoisting and loading the girders.

### 3.3 Casting, Curing, Testing and Instrumentation

An automatic concrete batching plant with a production capacity of 30 m<sup>3</sup>/hr was proposed adjacent to the casting yard, with separate bins for coarse and fine

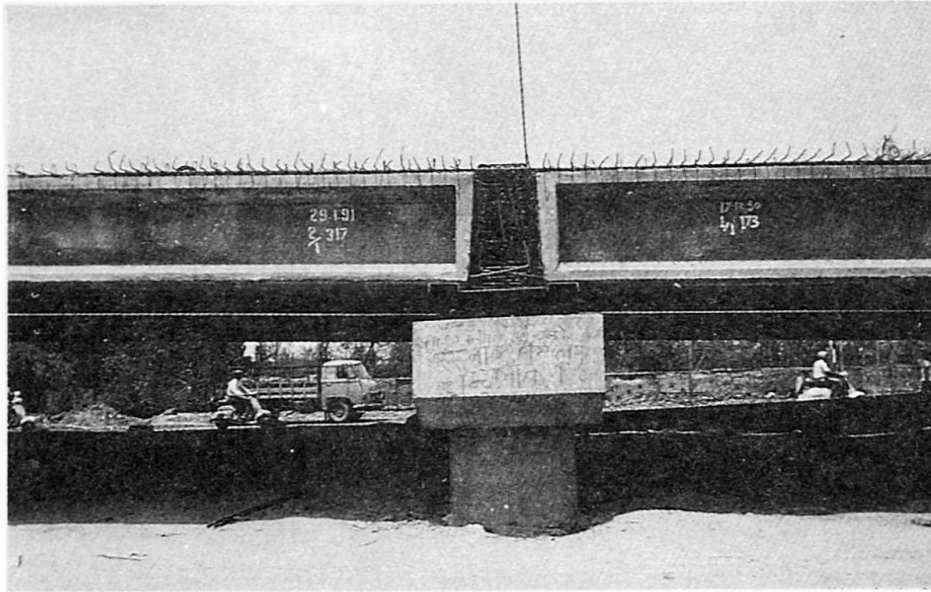

aggregates. The batching plant would provide adequately for the daily needs of the casting yard in about 4 hours.

Concreting was proposed to be carried out by using concrete pumps to meet the full production target. However, to start with, concreting was carried out by wing trolley.

Delayed steam curing, with an offset of 3 hours, is adopted to accelerate thermally the hydration of cement, with a view to increasing the turnover of the beams to meet the production target of 100 beams per month. The duration of the curing cycle is about 9 hours - two to three hours to raise the temperature to 70°C and also for cooling down and four hours of incubation at 70°C.

As per initial planning of casting four beams per day, it was sufficient to provide one boiler capable of producing 1500 kg steam per hour and accordingly one boiler was installed. However, two boilers of capacity 1500 kg/hour each, producing steam at a pressure of 10.54 kg/cm<sup>2</sup> are necessary for the peak hour production. Keeping a standby boiler, in case of break down and for maintenance, total number of boilers proposed for the factory was three. More details of steam curing are being included in a separate paper.

A fully equipped field laboratory is proposed to carry out all preliminary tests, works tests and to work out grading and proportioning of aggregates in order to obtain and maintain uniform quality of work as required. Specialised tests, such as for dimensional tolerance, ultimate tensile strength, yield point, 1000 hours relaxation etc. for prestressing strands are proposed to be conducted in an independent laboratory.

More details of precast factory are being included in a separate paper.

### 3.4 Casting of Fascia

The fascia are proposed to be cast in the precast factory in unit lengths of 2.0 m and transported to the site. The shape and size of fascia are to be decided on considerations of aesthetics and functionality.



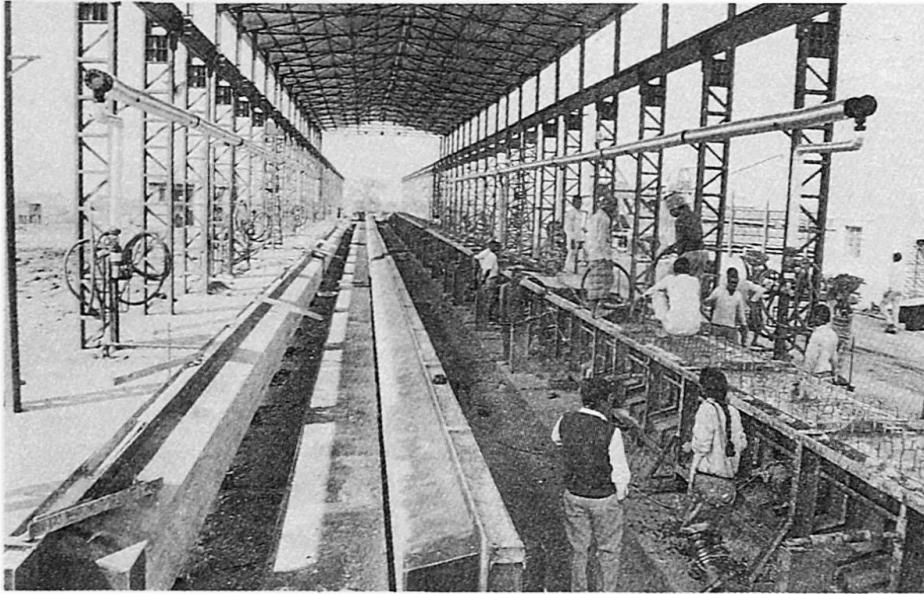

#### **4. TRANSPORT OF PRETENSIONED GIRDERS**

Before hoisting or transporting the girders, the transfer of prestress force has to be monitored. This is accomplished by fixing strain gauges at the support sections, at quarter points and the mid section. Tests on concrete samples, cured under the same conditions as the girders were, need to be conducted to ascertain the strength of concrete.

From the loading yard, the girders are hoisted on to a 50 t capacity truck trailer. The truck trailer handles three girders at a time.

#### **5. CONCLUSION**

The results of an integrated system approach in seeking a standardized design and construction programme for various flyovers in Delhi has been presented with a special emphasis on the precasting the element to an optimal capacity.

It is expected that the results of this exercise could be the forerunner for similar methods to be adopted in other metropolitan cities where rapid construction method without any disruption to the existing traffic flow is the prime consideration.

#### **6. ACKNOWLEDGEMENT**

The support of Delhi Tourism and Transportation Development Corporation through the evolution of the schemes and the U.P. State Bridge Corporation through the execution phase are gratefully acknowledged.

## Interchange at New Yamuna Bridge, New Delhi, India

Echangeur du pont sur le fleuve Jamuna à New Delhi

Kreuzung zur Neuen Jamuna Brücke bei New Delhi, Indien

**C.R. ALIMCHANDANI**  
Chairman & Man. Dir.  
STUP Consult. Ltd.  
New Delhi, India



C.R. Alimchandani, born in 1935, graduated in Civil Engineering from Pune, India. After an initial stint in various construction projects, he joined STUP Consultants Limited and is presently its Chairman & Managing Director. He has been associated with the design of several outstanding structures.

**S. RANGARAJAN**  
Princ. Consult.  
STUP Consult. Ltd.  
New Delhi, India



S. Rangarajan, born in 1943, obtained his Master's degree in Civil Engineering from Madras. After few years in a teaching career, he joined STUP Consultants Ltd and has been actively involved in the design of major concrete structures, prestressed concrete bridges, flyovers and highrise buildings.

### SUMMARY

The recently commissioned new bridge across River Yamuna at Delhi is located at an important point, close to the Inter State Bus Terminal (ISBT), Red Fort, Rajghat and the busy old Delhi shopping area. The new bridge has eight lanes of divided carriageway to carry the large volume of commercial traffic originating and terminating at Delhi. The interchange system on the western approach to the new bridge is a complete traffic system catering to a large volume of traffic. The interchange has an overall carriageway length of 3 km, making it one of the largest flyovers in India.

### RÉSUMÉ

Récemment mis en service, le pont enjambant le fleuve Jamuna à Delhi est situé à un point de circulation stratégique, entre la station d'autobus interrégionale, Red Fort, Rajghat et le centre commercial très actif de Delhi, la vieille ville. Le nouveau pont est pourvu d'une chaussée à huit voies séparées destinées à absorber une très forte densité de trafic à caractère commercial, partant et aboutissant à Delhi. L'échangeur réalisé sur l'accès ouest de ce pont est un système autoroutier complet, prévu pour drainer un énorme volume de circulation urbaine. Il comporte une longueur de chaussée développée de 3 km, devenant ainsi l'un des plus imposants passages supérieurs en Inde.

### ZUSAMMENFASSUNG

Die kürzlich dem Verkehr übergebene Brücke über den Jamuna bei Delhi liegt an einem wichtigen Knotenpunkt zwischen einer Überlandbuslinie und dem betriebsamen alten Einkaufszentrum von Delhi. Die neue Brücke hat acht Spuren auf zwei Fahrbahnen zur Aufnahme des grossen Verkehrsvolumens von und nach Delhi. Die Wesen Brückenzufahrt ist ein komplettes verkehrssystem mit insgesamt 3 km Fahrbahnen und damit einer der grössten kreuzungsfreien Verkehrsknoten Indiens.



## 1. GENERAL

### 1.1 Layout

The interchange consists of a main flyover ABCD (Fig.1). It has an eight lane divided carriageway and passes over the Ring Road, carrying traffic to and from the Yamuna bridge. EH and MJ are two slips, on Metcalf side and ISBT side respectively, which facilitate traffic flow both ways between Ring Road and the bridge. The two slips get connected to the loops GH and LM on Metcalf House side and ISBT side respectively.

Each carriageway on Flyover ABCD has a clear width of 14.5 m with footpath of 900 mm width and common central verge of 1800 mm width. A length of 155 m at the approach on the Boulevard Road side, with a gradient of 1.30 is on earthfill retained by RCC walls. The stilted portion of the flyover has continuous prestressed concrete box girder spans of about 32 m. The main crossing over the Ring Road has a span of 48.5 m with simply supported prestressed box girder with sections of uniform depth of 2200 mm for the entire structure.

The stilted portion of slip EH has ten continuous spans of about 25 m on a circular curve of radius of about 150 m. The carriageway has a clear width of 8.1 m with footpath width 1500 m on the inner side of the curve and a kerb of 600 mm width on the outer. The superstructure is of continuous box section,

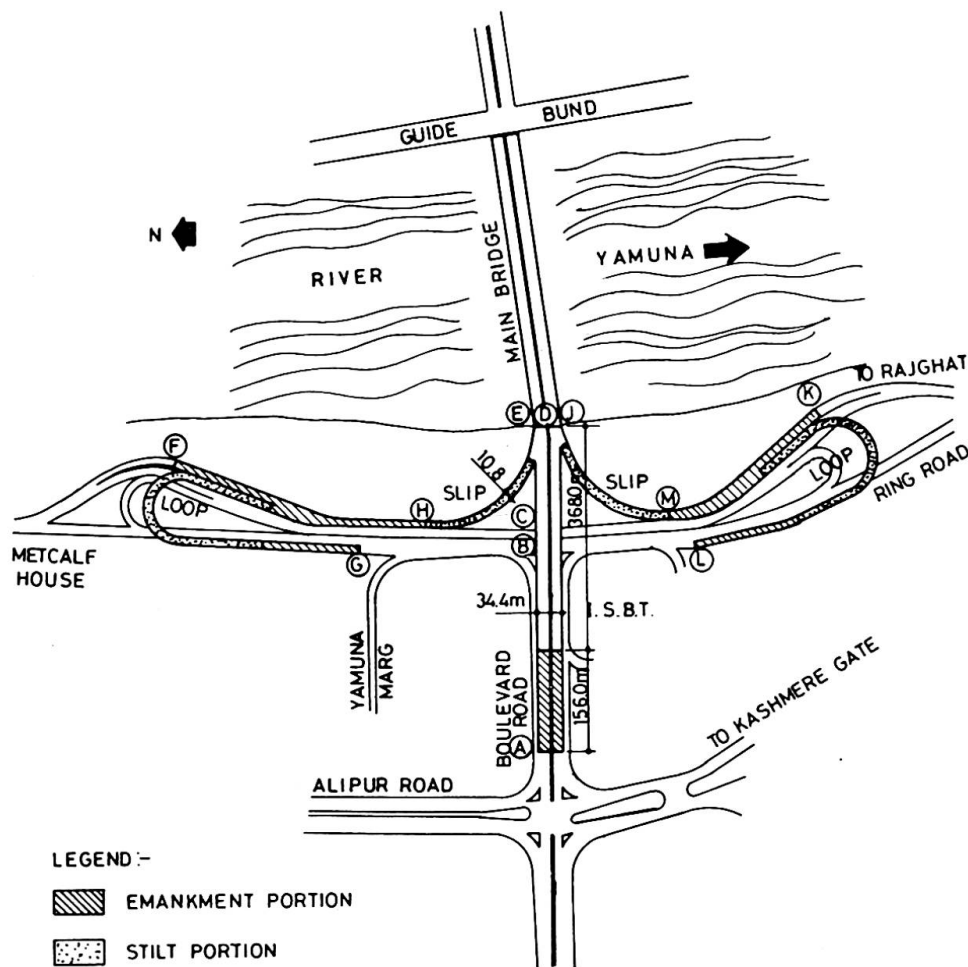

Fig. 1 General Layout

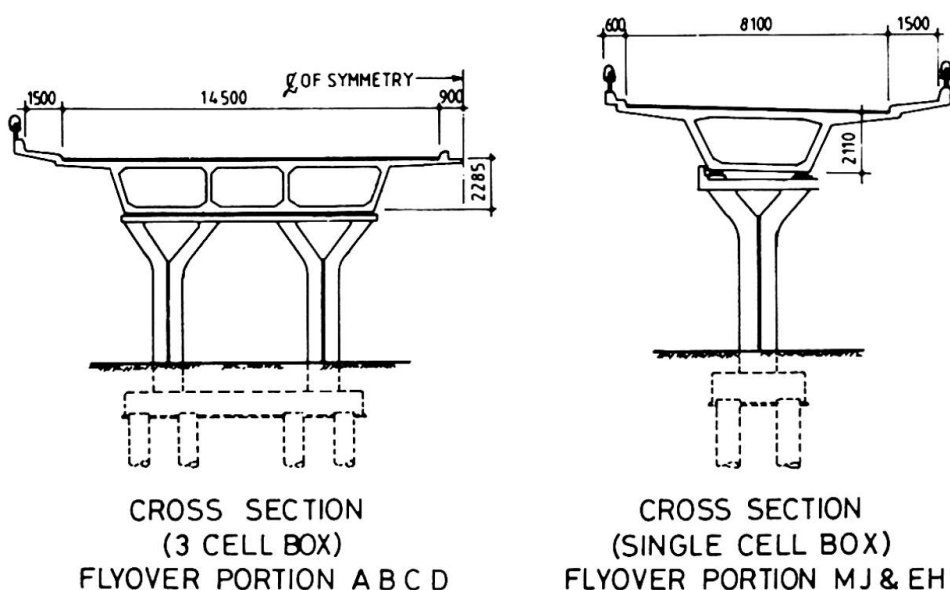

Fig.2 Cross Section of Flyover portion

longitudinally prestressed, resting on single pier at each support location within expansion joints at the ends of the circular portion. Slip MJ, similarly has ten spans of about 25 m on a circular curve of radius 165 m., with expansion joints at the ends.

The loops are in the configuration of a horse shoe with radii of about 50 m and 60 m. The loops have continuous prestressed concrete spans approximately ranging between 26 m to 40 m. The horse shoe portions with expansion joints at the ends have widened carriageway of 8.4 m clear width with footpath of 1500 mm width on the outer side and kerb of 600mm width on the inner side.

### 1.2 Foundations

The subsoil upto a depth of 40 m is generally alluvial in nature consisting of fine sand/silty clay with sand. At locations, rock was found at a depth of 20 m on the ISBT side of the ABCD flyover. Vertical bored cast-in-situ piles of 700mm diameter were adopted for foundations of the flyover. Slips and loops were subjected to large horizontal forces due to centrifugal action. Hence 500 mm diameter driven cast in situ piles, both vertical and raker were used for slips and loops. The lateral load on vertical pile under normal loading condition was restricted to 1% of the safe vertical load and to 5% under seismic loads.

### 1.3 Substructure

The pier column is of rectangular RCC Section with a fork at the top. A single pier column supports the two lane carriageway of slip and loop portions whereas the four lane carriageway of ABCD is supported on two pier columns.

The shape of the pier with a central groove and configuration of the top fork has been designed on aesthetic considerations. Fig.2 shows typical sections of the four lane and two lane flyovers.

### 1.4 Expansion Joints

A smooth riding surface is essential for high speed vehicles negotiating curved



flyovers. Hence, even at the tender stage, it was a requirement that curved portions shall be continuous. This was ensured by providing expansion joints at the ends of curved portions of the slip and loop flyovers. Specially manufactured neoprene slab expansion joints were used to permit large movements. The straight portions of the flyover are either two span continuous or single span simply supported structures.

### 1.5 Bearings

The superstructure of the ABCD flyover rests on reinforced neoprene bearing pads and the curved spans of slip and loop portions rest on POT-cum-PTFE bearings, with provisions for lateral restraints at the ends and a pin at the anchor pier locations. Fig.3 shows the type of bearings used for the typical loop portion, to illustrate the type of restraints imposed and movements permitted.

## 2. ANALYSIS AND DESIGN

### 2.1 Loading

The bridge portion is designed for combinations of live loads specified by the Indian Roads Congress. In the case of continuous spans, influence lines were plotted for moment, shear and torsion. Critical values were then obtained at various sections for moving trains and wheels. For ease of construction, spans of ABCD flyover and the slip portions, EH and MJ were cast as simply supported spans on sand jacks with construction gaps over pier and subsequently made continuous by casting these gaps, stressing continuity cables and finally lowering the span over the bearings on centre line of pier.

Due to this procedure, dead load analysis for simply supported spans was carried out in these cases. For the loop portions similar procedure was adopted except that two spans were cast at a time to ensure stability of the structure with a construction gap between adjacent pairs of spans.

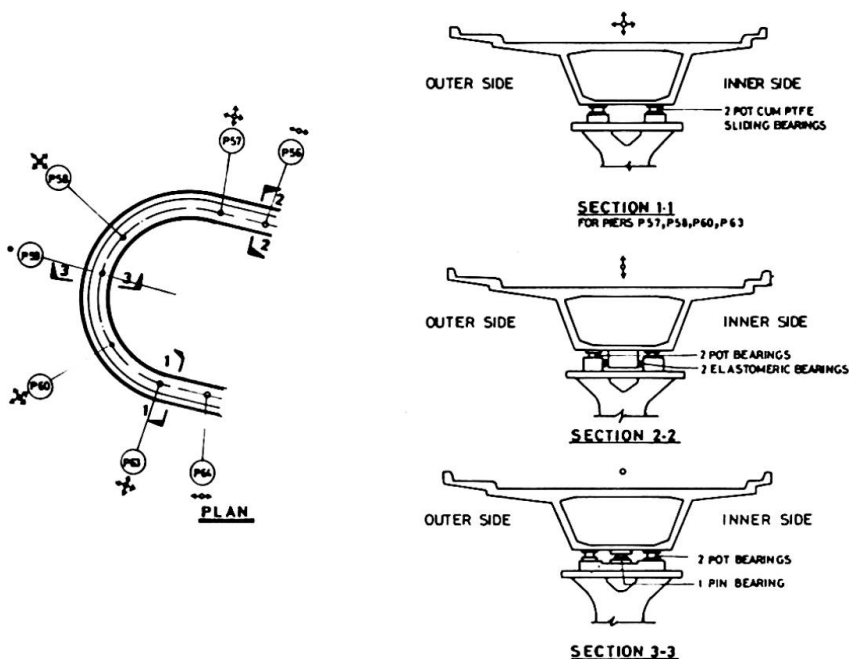

Fig. 3 Bearings for Loop Portion



## 2.2 Secondary Effects

In the design, a temperature gradient of 25 Deg.C. is considered in the top 200 mm thickness of deck slab. Differential settlement effect to the extent of 12mm between adjacent piers has been considered in the analysis. For the provision of prestressing, 50% of the differential settlement effect is provided for by prestressing and the balance taken by untensioned reinforcement. Secondary effects due to prestressing of continuity cables are calculated as per construction sequence.

The analysis of the curved flyovers has been carried out by the SAP IV PROGRAM taking the flexibility of piers into account. Box girder is idealised as a single line element with actual sectional properties. Boundary conditions at the pier top have been considered by introducing suitable end release codes.

## 2.3 Load Combinations

Normal load combinations involving dead load, superimposed dead load, live load, prestress, differential settlement, temperature gradient, seismic loading and wind loading are considered as per provisions of the Codes of the Indian Roads Congress. Permissible increase in allowable stresses are taken into account as per codal provisions. The seismic analysis is carried out using a static coefficient of 0.072 for horizontal effects.

## 2.4 Prestressing

Prestressing is carried out with HTS strands in standard 12T13 or 7T13 cables in suitable stages.

# 3. CONSTRUCTION ASPECTS

## 3.1 Service Lines

Existing service lines interfere with the construction of any urban interchange system. Water line, sewer lines, electricity and other cables had to be accommodated or relocated. The water line had to be accommodated by changing the pile layout and providing bridging pile caps over the pipe line in the stilted portion. In some portions of the embankment, pipe lines were taken inside hollow box RCC sections resting on ground. The use of box section instead of earthfilling, especially where the height of filling is above 6 m, restricted the bearing pressure under the base of box section to the required level. Fig. 4 shows the interchange under construction.

## 3.2 Traffic Diversion

Traffic diversion during construction was planned carefully since the entire superstructure was done on staging. During the construction of spans over the Ring Road, traffic was diverted on the adjacent spans and the casting sequence of spans provided for this arrangement. As already discussed, the continuous spans were cast as single spans with construction gaps filled later and rendered continuous through prestressing.

## 3.3 Piling

Bored cast-in-situ piles of 700mm diameter and driven cast-in-situ piles of 500mm diameter were adopted. The piles were driven to a depth of 18 to 20 m below ground level. The bored piles were designed for a safe load capacity of





1850 kN and the driven piles for 850 kN.

#### 4. CREDITS AND ACKNOWLEDGEMENT

The authors are thankful to the authorities of Delhi Administration for the information contained in this paper. The interchange was constructed by M/s.Uttam Singh Dugal & Co. and Simplex Concrete Piles and consultancy was rendered by STUP Consultants Limited.



Fig. 4 Flyover Portion 'E.H'

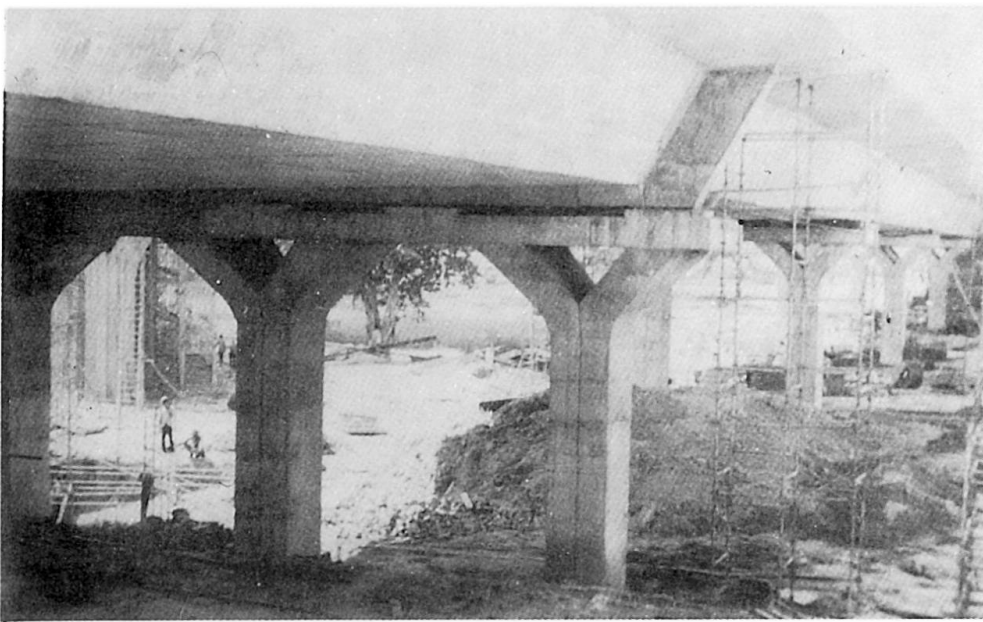

Fig. 5 Flyover Portion 'ABCD'

## Buckling of Extraordinary Deep and Slender Concrete Box Girders

Flambage des poutre-caissons très profondes et minces

Beulen ausserordentlich hoher und schlanker Betonhohlkästen

### Sankar C. DAS

Assoc. Prof.  
Tulane Univ.  
New Orleans, LA, USA

### Tyau-Da HUANG

Ph.D Candidate  
Tulane Univ.  
New Orleans, LA, USA

### Xianghui ZHANG

Ph.D. Student  
Tulane Univ.  
New Orleans, LA, USA

Sankar C. Das, born in 1940, received BECE from Calcutta Univ. MS from Brown Univ. and MS and Ph.D from Univ. of Missouri, Columbia. Assoc. Prof. in Civil Eng. Tulane Univ. in the area of Structural Mechanics, he is currently doing research on buckling of slender concrete box girders.

Tyau-Da Huang, born in 1953, is a registered professional engineer at Avondale Industries, Inc, and a Ph.D. candidate in the Civil Eng. Dep. at Tulane Univ. He received his B.S. in 1976 from National Chung-Hsing Univ. Taiwan, and his M.S. from Ohio State Univ. Columbus, Ohio.

Xianghui Zhang, born in 1964, got his BS and MS in Engineering Mechanics at Shanghai Jiao Tong University. Presently he is working towards the Ph.D degree.

### SUMMARY

It is necessary to consider the stability problem of very long-span deep and slender concrete box girders or concrete folded plate structures. The computer-based nonlinear finite element numerical technique involving large deflection theory, nonlinear material characteristics, cracking, concrete rebar interface etc. is used for the calculation of the instability of reinforced concrete plate elements and folded plate model.

### RÉSUMÉ

Il faut considérer le problème de la stabilité des poutres-caissons profondes et minces de très longue portée ou des structures en béton faites en plaques plissées. Un programme d'éléments finis non linéaires tenant compte des grandes déformations, des propriétés non linéaires des matériaux, de la fissuration et de l'interface acier-béton a été utilisé pour le calcul de l'instabilité des plaques et plaques plissées en béton armé.

### ZUSAMMENFASSUNG

Es ist notwendig, das Stabilitätsproblem sehr langer, hoher und schlanker Stege von Betonhohlkästen zu betrachten. Für ihre Stabilitätsberechnung als Stahlbetonscheiben und -faltwerke werden numerische Verfahren der Finite-Element-Methode eingesetzt, die die Nichtlinearität infolge grosser Deformationen, hoher Materialausnutzung, Rissbildung, Verbundschlupf usw. berücksichtigen.



## 1. INTRODUCTION

Reinforced and prestressed concrete panels are commonly used as structural elements of large box girder bridges, folded plate roofs, etc. Very deep and slender concrete box girder sections may be considered as thin folded plate structures and it is conceivable that some form of buckling may take place under the action of various load combinations, smaller in magnitude than those methods which do not consider stability. Complex geometric shapes and the concrete material with stress-strain relationships exhibiting different behaviors in tension and in compression of the above mentioned structures, effective and useful prediction of buckling response or post-buckling load carrying capacity via analytical approaches is generally very difficult. Therefore, numerical means such as the nonlinear finite element method is used in this instability study.

Separate modeling is used for the rebar and the concrete. Rebar is treated as an elastic-plastic metal. The concrete itself is modeled with an elastic-plastic-failure theory due to Chen and Chen's model [1,2]. This is an associated flow, isotropic hardening theory based on the yield surfaces written in terms of the first two stress invariants and parameters which are chosen to fit uniaxial and biaxial yield and failure data.

## 2. STRESS-STRAIN RELATIONS OF CONCRETE

A plasticity model originally developed by Chen and Chen [1,2] is utilized to represent the stress-strain response of concrete. The model consists of a compressive yield/flow surface to model the concrete response in predominantly compressive states of stress, together with damaged elasticity to represent cracks that will occur at a material calculation point.

The model thus uses the classical concepts of plasticity theory: a strain rate decomposition into elastic and inelastic strain rates; elasticity; yield; flow and hardening [1,2,3,8]. Cracking dominates the material behavior when the state of stress is predominantly tensile. Cracking failure is defined by the maximum principal strain reaching a critical value, with cracks normal to that direction. In cracked zones a strain softening model is assumed for the direct stress across the cracks, and for the shear stiffness. Subsequent to cracking failure, elastic-plastic calculations are continued in a reduced stress space containing those components not associated with the crack normal direction so long as the cracks are open. The basis of the post cracked behavior is the brittle fracture concept of Hilleborg [4]. The uniaxial behavior of concrete is shown in Fig. 1 and failure surfaces are shown in Fig. 2.

## 3. MODELING OF REINFORCEMENTS

It is intended that reinforced concrete modeling be accomplished by combining standard elements, using the plain concrete model with rebar elements, defined singly or embedded, that use one dimensional strain theory. This modeling approach allows the concrete behavior to be considered independently of the rebar. The nonlinear effects of the rebar and concrete interface, such as dowel action and aggregate interlock were modeled through the uses of "tension stiffening" and "shear retention strain" [1 thru. 3] which will simulate the load transfer across cracks through the rebars.



#### 4. NUMERICAL ANALYSIS

The constitutive relations of reinforced concrete outlined in references [1, 2] have been implemented into a nonlinear finite element program ABAQUS [3] for application purposes. ABAQUS is a nonlinear incremental finite element structural analysis program for large strain and large displacement problems. The program provides a general interface so that the user may introduce own material constitutive model in a "user subroutine". To illustrate the applicability of the above constitutive model, the buckling responses of fourteen reinforced concrete rectangular plates and of a long-span reinforced concrete folded plate model were examined by the finite element analysis [5,6,7,8]. The reason for choosing these R.C. rectangular plates and the folded plate model for the analysis is that the experimental data are available for comparison [9,10,11].

##### 4.1 Rectangular plates

Fourteen rectangular reinforced concrete plates selected [5,6,8] for nonlinear buckling analysis, have the dimensions as shown in Fig. 3, 4 ft. (1,219 mm) x 8 ft. (2,436 mm). They are reinforced by two layers of welded wire mesh. The eight node thin shell elements, S8R5 ( 5 D.O.F. per node) with four integration points on the surface and nine integration points through the thickness of the element are used in the finite element model. Various plate thickness, reinforcement ratios, maximum concrete compressive strengths, and the comparison of experimental buckling and post-buckling results with that of nonlinear numerical results are summarized in reference [5,6,8]. The maximum load-deflection plots, buckling-load points, and the post buckling load points for the plates no. 19 and 23 are shown in Figs. 4 and 5. The plot of non-dimensional buckling stress versus slenderness ratio and the comparison of experimental results with that of F.E. results are shown in Fig. 6 [5,8].

Plate No. 19 [Plate thickness, 0.757 inch; nominal steel area  $\rho$ , 0.50; cyl. strength, 3,448 psi]

##### Buckling Load

Experiment-70.1<sup>k</sup> (314.05kN)  
F.E.-65.0<sup>k</sup> (291.2kN)

##### Post-buckling load

Experiment-84.9<sup>k</sup> (380.35kN)  
F.E.-80.9<sup>k</sup> (362.43 kN)

Plate No. 23 [Plate thickness,0.763 inch; nominal steel area  $\rho$ , 1.0; cyl. strength, 3,396 psi]

##### Buckling Load

Experiment-70.0<sup>k</sup> (313.6kN)  
F.E.-68.2<sup>k</sup> (305.54kN)

##### Post-buckling load

Experiment-78.0<sup>k</sup> (349.44kN)  
F.E.-79.8<sup>k</sup> (357.5kN)

The numerical buckling and post buckling analysis [5,6,8] of R.C. rectangular plates agreed very well with that of experimental results [9,10].

##### 4.2 Long-span reinforced and prestressed concrete folded plate model

A uniformly loaded post-tensioned lightweight concrete folded plate unit was tested by I. Martin [11]. During the experiment, a buckling failure mode was detected. The overall dimensions of the model is shown in Figs. 7 and 8. To solve the problem numerically, a finite element model (Fig. 9) is developed and more than forty-five nonlinear incremental analyses are performed through the computer program ABAQUS [3]. There are 84 elements and 293 nodes in the model. Material properties given [11], and other estimated values [1,2,3] for the constitutive formulations of concrete and steel are shown in Tables 1 and 2. The results of the analysis are shown in Figs. 10 thru 13.



**Buckling Load**

Experiment-34.0 psf (1,628 Pa)

F.E.-31.9 psf (1,527 Pa)

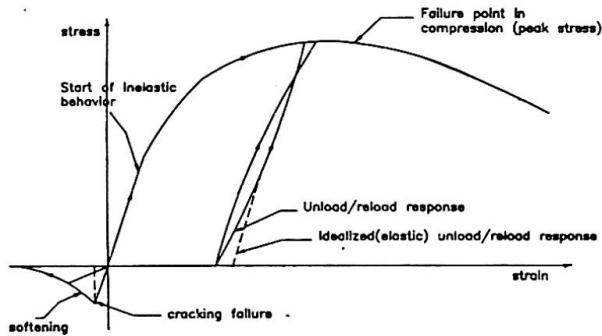

Fig. 1 Uniaxial Behavior Of Plane Concrete

**Post-buckling Load**

Experiment-Not available

F.E.-38.8 psf (1,858 Pa)

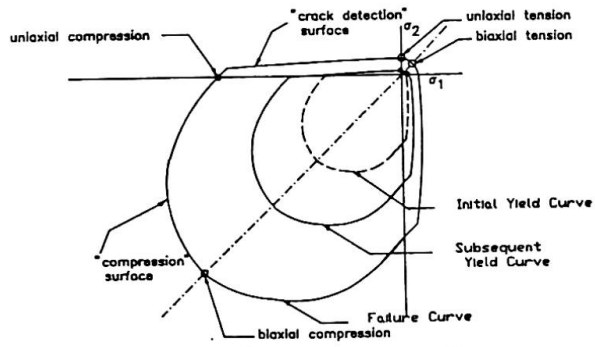

Fig. 2 Concrete Failure Surfaces In Plane Stress

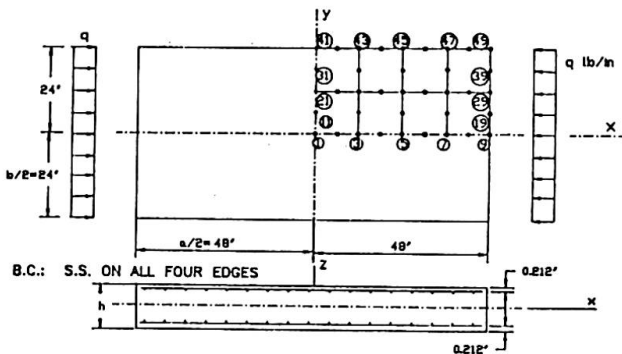

FIG. 3. F.E. Plate Model with Coordinate System (1 in = 25.4 mm)

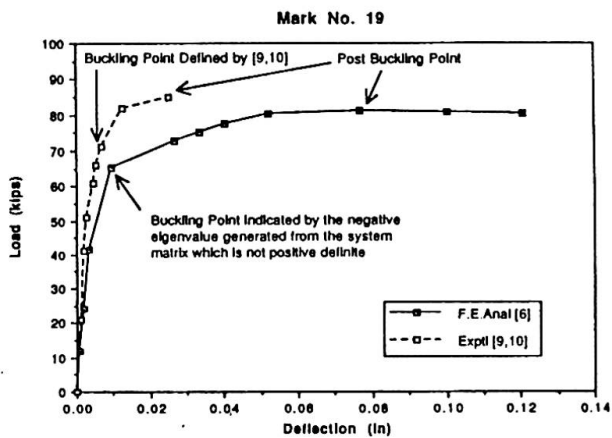

FIG. 4. Deflection at Node 1 in Z-direction (1 in = 25.4 mm; 1 kip = 4.48 kN)

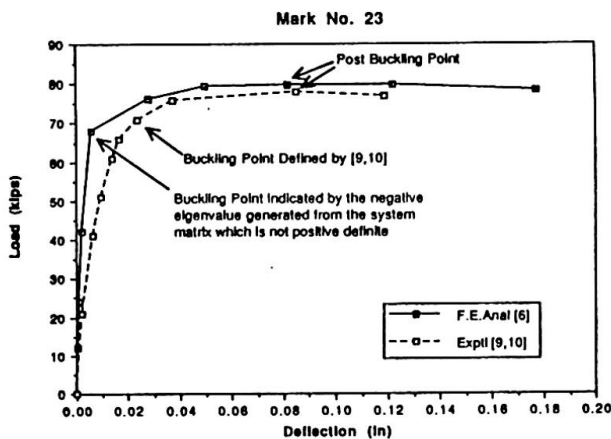

FIG. 5. Deflection at Node 1 in Z-direction (1 in = 25.4 mm; 1 kip = 4.48 kN)

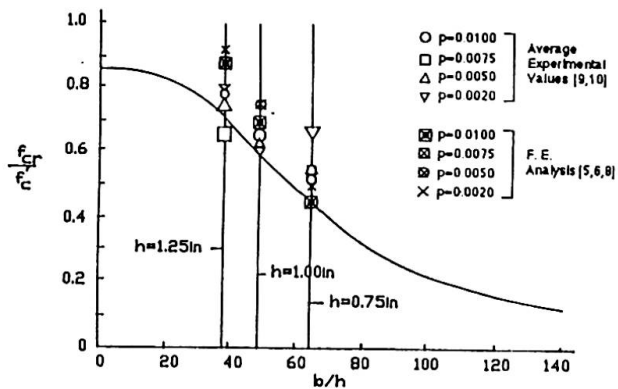

FIG. 6. Concrete Buckling Stress Versus Plate Thickness - Comparison of Experimental Results with F.E. Analysis (1 in = 25.4 mm)

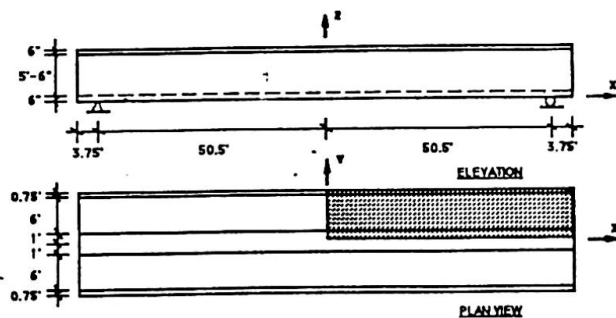

FIG. 7. Reinforced and Prestressed Concrete Folded Plate Model (1 in = 25.4 mm)

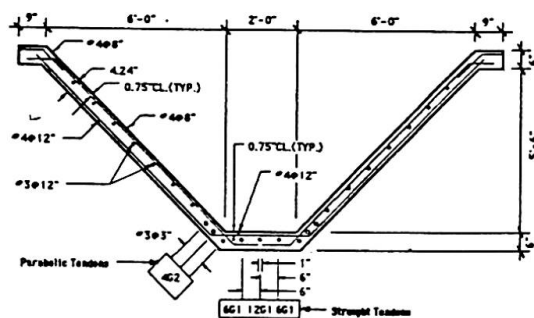

FIG. 8. Cross-Section of the Model with Reinforcements (1 in = 25.4 mm)

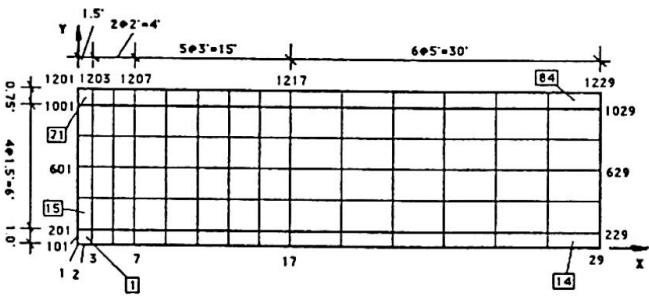
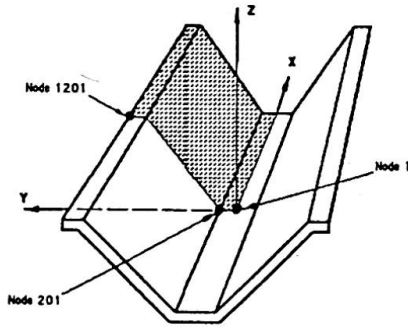

FIG. 9. Finite Element Model ( 1 in = 25.4 mm )

Elastic Modulus	$E_c = 2.31 \times 10^6$ psi
Poissons Ratio	$\nu = 0.2$
Uniaxial compressive yield @ zero plastic strain	$\sigma_c^y = 2320$ psi
Uniaxial compressive failure strength	$\sigma_c^u = 5160$ psi
Plastic strain at uniaxial compressive failure	$\epsilon_{11}^{pl} = 0.0025$
Biaxial to uniaxial compressive strength ratio	$r_{bc}^c = 1.16$
Uniaxial tension to compression strength ratio	$r_t^c = 0.075$
Ratio of plastic strain in biaxial compression to uniaxial compression failure	$r_{bc}^t = 1.28$
Cracking failure ratio in plane stress with one principal stress at compressive failure	$f = \sigma_{t1}/\sigma_c^u = 0.333$
Post-failure strain of tension stiffening effect	$\epsilon_t^u = 4.0 \times 10^{-4}$
Shear retention factor and strain	$\rho^{tose} = 1.0$ @ $\epsilon_{max} = 0.005$
Mass density	$\rho_{cm} = 1.51 \times 10^{-4}$ lb·sec <sup>2</sup> /in <sup>3</sup>

Note: 1 psi = 6.895 kPa; 1 lb·sec<sup>2</sup>/in<sup>3</sup> = 0.1069 N·sec<sup>2</sup>/cm<sup>3</sup>

Table 1 Concrete Properties - Folded Plate Model

Steel Name	Yield Stress (ksi)	Yield Strain	Ultimate Strength (ksi)	Elastic Modulus (ksi)
Steel No. 1 #3 & #4 bars	60.0	0.00207	90.0	29,000
Steel No. 2 prestress tendon	192.0	0.00662	240.0	29,000

Mass Density  $\rho_{cm} = 7.33 \times 10^{-4}$  lb·sec<sup>2</sup>/in<sup>3</sup>

Note: 1 ksi = 6,895 kPa; 1 lb·sec<sup>2</sup>/in<sup>3</sup> = 0.1069 N·sec<sup>2</sup>/cm<sup>3</sup>; 1 in = 25.4 mm

Table 2 Steel Material Properties - Folded Plate Model

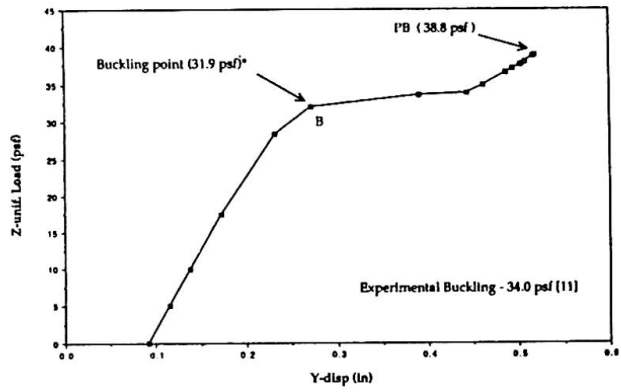

\* Indicated by the negative eigenvalue generated from the system matrix which is not positive definite

Fig. 10 Deflection @ Node 1201 in Y-direction ( 1 psf = 47.88 Pa ; 1 in = 25.4 mm )

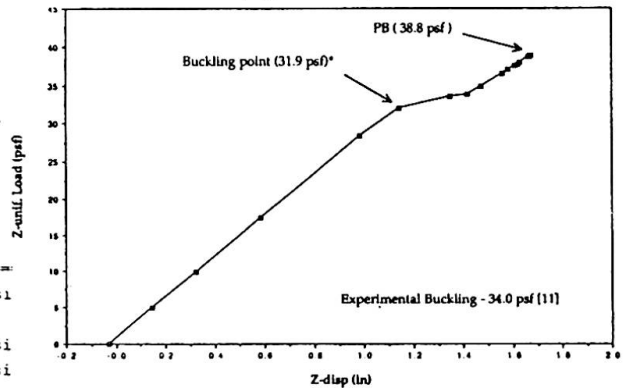

\* Indicated by the negative eigenvalue generated from the system matrix which is not positive definite

Fig. 11 Deflection @ Node 1201 in Z-direction ( 1 psf = 47.88 Pa ; 1 in = 25.4 mm )

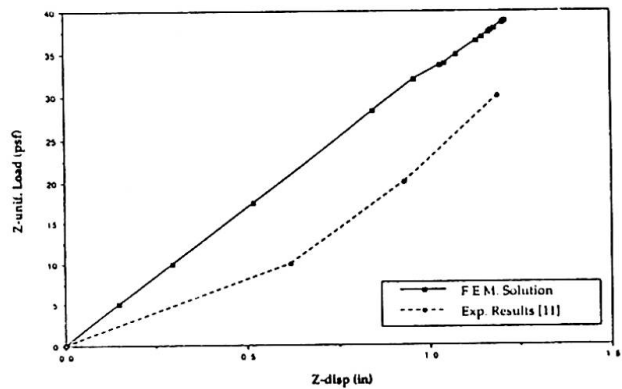

Fig. 12 Deflection @ Node 1 in Z-direction ( 1 in = 25.4 mm ; 1 psf = 47.88 Pa )

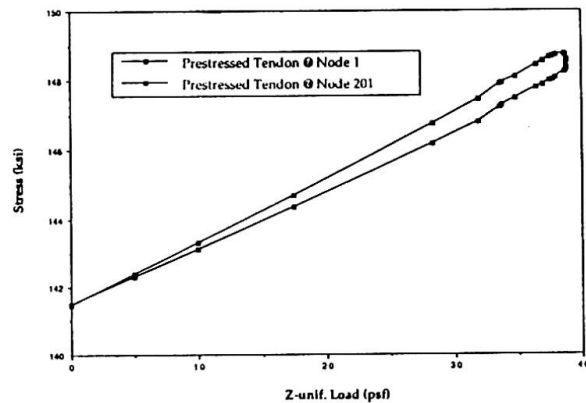

Fig. 13 Stress of Tendon in X-direction ( 1 ksi = 6,895.0 kPa ; 1 psf = 47.88 Pa )





## 5. CONCLUSIONS

(1) Local buckling may take place in very deep and slender box girder sections under the action of various load combinations, smaller in magnitude than those methods which do not consider buckling.

(2) The experimental buckling load for the folded plate model [11] is equal to 34.0 psf which is in fact the post-buckling load and it fits exceptionally well between the numerical buckling load of 31.9 psf and the numerical post-buckling load of 38.8 psf obtained from the F.E. method.

(3) Nonlinear F.E. analysis method involving elasto-plastic associated flow isotropic hardening constitutive relations for concrete and rebar treated as elastic-plastic metal can successfully predict the buckling load and the post-buckling strength of R.C. plate elements, folded plate structures and other R.C. structures.

## 6. ACKNOWLEDGMENT

The research described herein was supported by the National Science Foundation Grant MSM-8919385 to Tulane University, New Orleans, Louisiana. This support is gratefully acknowledged.

## REFERENCES

1. CHEN, A.C.T. and CHEN, W.F., Constitutive Relations of Concrete. J. Engrg. Mech. Div., ASCE, 101 (4), August 1975. pp. 465-481.
2. CHEN, A.C.T. and CHEN, W.F., Constitutive Equations and Punch-Indentation of Concrete. J. Engrg. Mech. Div., ASCE 101, December 1975, pp. 889-906.
3. ABAQUS Manuals, Vol. 1: User's Manual, Vol. 2: Theory Manual, Vol. 3: Example Problems Manual, Vol. 4: System Manual, Version 4.8, Habbitt, Karlsson and Sorensen, Inc., Providence R.I., 1989.
4. HILLEBORG, A.M.M., and PETERSON, P.E., Analysis of Crack Formation and Crack Growth in Concrete by Means of Fracture Mechanics and Finite Elements. Cement and Concrete Research, 6, 1976, pp. 773-782.
5. DAS, S.C., Local Buckling of Concrete Box Girder Plate Elements. Presented at the TRB Comm. A2C03, Concrete Bridge Meeting, Washington, D.C., January 14, 1991, pp. 1-45.
6. DAS, S.C., HUANG, T.D. and ZHANG, X., Numerical Buckling Analysis of Concrete Plate Elements and Comparison with that of Experimental Results. Report No. ST-91-1, submitted to the NSF, part of the NSF project MSM-8919385, March 15, 1991.
7. DAS, S.C., HUANG, T.D., and ZHANG, X., Nonlinear Finite Element Buckling Analysis of a Long-Span R.C. Folded Plate Model. Report No. ST-91-2, Submitted to the NSF, part of the NSF Project MSM-8919385, April 17, 1991.
8. DAS, S.C., HUANG, T.D., and ZHANG, X., Buckling Analysis of Ultra Deep R.C. Box Girders Bridges. International Conference on New Dimensions in Bridges & Flyovers, June 27-28, 1991, pp. 85-92.
9. SWARTZ, S.E., ROSEBRAUGH, V.H. and et al., Buckling tests on Rectangular Concrete Panels. J. of the ACI, 71 (1), 1974, pp. 33-39.
10. SWARTZ, S.E., ROSEBRAUGH, V.H., Buckling of Reinforced Concrete Plates. J. of the Struct. Div., ASCE, 100 (1), 1974, pp. 195-208.
11. MARTIN, I., Full Scale Load Test of a Prestressed Folded Plate Unit. J. of the ACI, December 1971, pp. 937-944.