

Zeitschrift: IABSE congress report = Rapport du congrès AIPC = IVBH
Kongressbericht

Band: 14 (1992)

Artikel: Structural system reliability analysis: the key to designing for disasters

Autor: Karamchandani, A.K.

DOI: <https://doi.org/10.5169/seals-13790>

Nutzungsbedingungen

Die ETH-Bibliothek ist die Anbieterin der digitalisierten Zeitschriften. Sie besitzt keine Urheberrechte an den Zeitschriften und ist nicht verantwortlich für deren Inhalte. Die Rechte liegen in der Regel bei den Herausgebern beziehungsweise den externen Rechteinhabern. [Siehe Rechtliche Hinweise.](#)

Conditions d'utilisation

L'ETH Library est le fournisseur des revues numérisées. Elle ne détient aucun droit d'auteur sur les revues et n'est pas responsable de leur contenu. En règle générale, les droits sont détenus par les éditeurs ou les détenteurs de droits externes. [Voir Informations légales.](#)

Terms of use

The ETH Library is the provider of the digitised journals. It does not own any copyrights to the journals and is not responsible for their content. The rights usually lie with the publishers or the external rights holders. [See Legal notice.](#)

Download PDF: 08.02.2025

ETH-Bibliothek Zürich, E-Periodica, <https://www.e-periodica.ch>

Structural System Reliability Analysis — The Key to Designing for Disasters

Analyse de la fiabilité des structures face aux catastrophes

Zuverlässigkeitsanalyse von Tragsystemen gegen Katastrophen

A.K. KARAMCHANDANI

Dr.
STUP Consult. Ltd
Bombay, India



Dr. A.K. Karamchandani obtained his Ph.D. from Stanford Univ. USA. His area of interest is safety of structures and he has been a consultant on this subject to organisations in India, Norway and USA. He is currently working on bridge engineering

SUMMARY

Structural systems are usually redundant and failure of an individual element does not constitute structural collapse. Therefore, for a realistic evaluation of the safety of a structure, one has to use systems reliability approaches in which the focus is on sequences of element failures leading to overall collapse. In this paper, insight gained from such systems reliability studies of offshore jacket platforms is presented. These include the advantages of x-bracing over k-bracing in extreme storms, selection of design waves to represent extreme storm loads, quantification of the benefits of redundancy for fatigue loads and safety under combined sources of risk.

RÉSUMÉ

Les systèmes structuraux ont en principe un caractère redondant et la défaillance d'un élément n'entraîne pas l'effondrement de la structure. En vue d'une évaluation réaliste de la sécurité du système structural, il est ainsi suggéré d'utiliser des méthodes d'étude de la fiabilité dans lesquelles l'essentiel consiste à opérer une succession de défaillances d'un élément qui entraîne l'effondrement total de la structure. Cet article présente un aperçu des études relatives à la fiabilité d'un système structural constituant les plates-formes de forage en mer proches du littoral. Il expose les avantages des contreventements en X sur ceux en K au cours de tempêtes de type extrême, la sélection de vagues modèles servant au calcul des charges extrêmes de tempête, la quantification des avantages de redondance pour les charges de rupture et la sécurité par combinaison des sources de risque.

ZUSAMMENFASSUNG

Tragsysteme weisen im allgemeinen eine Redundanz auf, dank deren das Versagen eines Einzelelements nicht zum Kollaps des Gesamtsystems führt. Eine wirklichkeitsnahe Analyse der Tragwerkssicherheit muss deshalb die Reihenfolge des zum Kollaps führenden Elementversagens berücksichtigen. Der vorliegende Beitrag stellt Erkenntnisse aus Zuverlässigkeitsanalysen aufgeständerter Offshoreplattformen vor, unter anderem die Vorteile von X-gegenüber K- Verbänden unter extremer Sturmeinwirkung, die Wahl repräsentativer Bemessungswellen, den qualifizierten Nutzen von Redundanz gegenüber Ermüdung und die Sicherheit unter kombiniert auftretender Gefährdungen.



1.0 INTRODUCTION

Ideally, a structure should be constructed to withstand every conceivable disaster without any damage. However, this is economically not possible. A more practical outlook, reflected in today's seismic design philosophy, is to design structures for two levels of loads. For disasters that are likely to occur during its lifetime, the structure is designed to survive without any damage whatsoever. However, in the case of a larger than anticipated disaster, the structure may undergo some damage, but it should not collapse and the loss of life should be minimal.

Traditional code based design has focused on the first level of safety, i.e., each individual member is designed to have adequate strength to withstand the maximum load anticipated during the life of the structure. However, when assessing the ultimate safety of the structure, one has to recognize that most structures are redundant and failure of an individual member does not usually constitute collapse. Hence, to evaluate ultimate structural safety, one has to go beyond the level of individual member failures and look at the problem from a **systems** point of view. Furthermore, because both the load and the strength of the structure are uncertain, one needs a probabilistic approach for a realistic evaluation of structural safety.

In the past decade there has been considerable development of such probabilistic systems approaches (Karamchandani, 1987). One especially useful approach is the "failure path approach". In this approach, the focus is on identifying sequences of member/section failures that lead to structural collapse. Typically, there are a very large number of such collapse sequences and therefore search techniques are used to identify the important sequences, i.e. the sequences that are most likely to occur. The probability of system failure is then approximated as the probability that one of these important sequences will occur.

There have been many applications of the failure path approach to structural problems in the past five years. In this paper, the focus is on insights gained from some of these applications—in specific, from a set of projects on offshore structures. These include comparison of alternate structural configurations, selection of wave load patterns for design, safety under fatigue loads and safety under combined sources of risk.

2.0 EFFICACY OF K AND X BRACING SYSTEMS FOR OFFSHORE STRUCTURES UNDER EXTREME STORMS

In the case of failure of an offshore steel jacket platform under an extreme wave in a storm, the critical elements are usually the braces. Typically, these are either in a "K" or an "X" configuration. To study the effect of these configurations on structure safety, Nordal et al., 1988, studied an eight-leg structure (Fig.1) with both "K" and "X" configurations for the bents (Fig.2). In both cases, the braces were sized using API (American Petroleum Institute) guidelines and a similar level of conservatism was maintained (i.e. the "unity" checks were similar).

In the analysis, the structure was modeled as a truss with the elements having piece-wise linear force - deformation characteristics (Fig.3). Note that after compression failure, the force in the element drops to a fraction (40%) of the value at failure. This is consistent with the fact that the braces are slender and buckle in compression.

The element capacities are treated as random variables. The mean values and standard deviations of these capacities are based on experimental test data. The wave load was modeled by a fixed pattern (corresponding to a 100 year design wave) and a random magnitude. The results of the analysis are presented in the failure trees of Figure 4 & 5. In these trees, each branch corresponds to failure of an element and each node corresponds to a damaged state of the structure. The number in the node is the possibility of reaching the corresponding damaged state, i.e., it is the probability of occurrence of the sequence of element failures represented by the branches leading to the node.

Note that the probability of an initial failure is much larger in the K-braced case, i.e. the effective strength of the brace in the X configuration is much higher. This is due to two factors. The first factor is as follows. The force in the brace in the X-configuration is due to both the extreme wave load and the dead load while in the Y configuration, it is only due to the extreme wave load. In the design process, an extra margin in strength is provided on the total force, e.g., in the X-case there

is a margin on the force due to the extreme wave and on the force due to the dead load. However, in the event of an extreme wave in a storm, it is unlikely that the dead load will also be excessive and therefore the extra margin for the dead load can be used to resist the force due to the extreme wave resulting in a larger effective strength. The second factor that causes a greater effective strength in the X-configuration is that the code is more conservative in predicting the strength of an X-brace.

It is also interesting to note that there is a large systems effect for the X-configuration, e.g., in the most important collapse sequence, the probability of occurrence of the full sequence is much smaller than the probability of occurrence of the initial failure. The systems effect is much less in the K-configuration. This difference is due to the difference in the post-failure behaviour of the K-configured panel and the X-configured panel. In both cases, the capacities of the braces are usually lower in compression and therefore the initial failure is typically a compression failure. In the K-configuration, due to static equilibrium constraints, the force in the tension brace is the same as in the compression brace. Hence, after a compression brace fails in the panel, the force in the tension member drops to match the post-failure drop in the compression member, i.e., the post-failure force in the panel is twice the post-failure force in the compressive brace.

The behaviour of the X-configured panel is very different. When the compression brace fails, there is no drop in the force in the tension brace - in fact it usually keeps increasing. In other words, the drop if any in the post-failure capacity of the X-configured panel is much smaller than the drop in the K-configured case. This leads to a larger ultimate system strength in the X-configured case and a correspondingly larger systems effect.

3.0 SELECTION OF CRITICAL WAVES FOR DESIGN OF OFFSHORE STRUCTURES UNDER EXTREME STORMS

Storms are a major source of risk for offshore structures and therefore, these structures are designed to withstand a large wave such as a 100 year extreme wave (i.e., the largest wave that is expected in a 100 year period). Due to the safety factors inherent in design, the structure will usually withstand this design wave with no damage and collapse will only occur under a much larger wave. The load pattern will be quite different for this larger wave. Therefore, basing the design on the load pattern corresponding to the smaller wave may be inappropriate.

This issue was studied by De, et.al., 1991, using the eight-leg jacket structure of Fig.1 (X-braced bents). It was found that if the pattern corresponding to a 65 foot wave (i.e. a 100 year design wave) is used and only the wave load magnitude is varied, then the critical members (which form the most important sequence) are in tier 2 (Fig.6). However, if a structural reliability analysis is carried out in which the wave pattern varies with magnitude (i.e. both are a function of wave height), then it is found that the structure is most likely to collapse under a 75 foot wave. The critical members for this wave are in tier 3 (Fig.7). In other words, for a typical offshore structure, the critical members in design may not be the members that are most likely to fail in an extreme storm.

4.0 RELIABILITY OF STEEL JACKET PLATFORMS UNDER FATIGUE

A large number of steel jacket offshore structures have exceeded their design life, but they are still being used as they are located on operational fields. Although many of these structures are safe with respect to extreme environmental loads, they are susceptible to fatigue failures. Studies have shown that due to the large uncertainties in fatigue strength, the probability of having a single member fail in an aging structure is quite high. Therefore there is growing concern about the safety of these structures.

However, these structures are redundant and therefore, due to systems effects, the overall safety may still be quite high. To quantify these systems effects, Karamchandani, et.al., 1992, studied a tripod structure located in the North Sea in a water depth of 70m and with an airgap of 22m (Fig.8).

Fatigue failures in jacket structures tend to occur at ends of members (i.e., at the joints). Hence, in the analysis, sections at both ends of the members were considered as potential failure sites. The failure path approach was used and the important sequences identified are shown in Fig.9.



It is interesting to note that the individual section that is most likely to fail has a failure probability of 0.00307 while the most likely collapse sequence has a probability of occurrence of 0.000058. Similarly, the probability of having at least one member failure (i.e., probability of any section failure in the intact structure) is 6.01×10^{-3} while the probability of system failure is 1.63×10^{-4} . Hence the conditional probability that system failure occurs given at least one section has failed in the intact structure is $1.63 \times 10^{-4} / 6.01 \times 10^{-3} = 0.027$. That is, even after an individual section has failed, the probability of system failure is quite small.

It should be noted that the tripod structure is not very "redundant", i.e., only two element failures are required for structure collapse. However, if a more redundant structure is considered (e.g. a six or eight leg jacket), then the systems effects will be even larger.

5.0 SAFETY OF JACKET STRUCTURES UNDER COMBINED SOURCES OF RISK

As seen in the above section, there are large systems effect in steel jacket structures subject to fatigue. Therefore, total structural collapse under fatigue loading may not be a critical issue. However, the probability of an individual member failing in fatigue is quite high and this may weaken the structure making it susceptible to failure under a large wave in a storm. This issue of a combination of sources of risk (i.e., an initial failure in fatigue followed by structural collapse under extreme wave) was studied by Karamchandani, et al., 1991 for the tripod structure of Fig.8.

A failure path approach was used and the important sequences identified are shown in Fig.10. The first failure is a fatigue failure and the second failure is a failure under an extreme wave. It is interesting to note that for the second failure, the members that are critical in the case of fatigue (second set of branches in Fig.9) are not the same as those that are critical under the extreme wave (second set of branches in Fig.10).

As expected, the probability of occurrence of the most likely sequence of combined failures, i.e., fatigue failure of section 680B followed by failure of member 620 under an extreme wave, is much higher than the probability of occurrence of the most likely sequence of fatigue failures, section 680B followed by section 611B (0.000217 versus 0.0000582). However, it is interesting to note that if one looks at the overall system failure probability in these two cases, the difference is much less (0.000234 for the combined case and 0.000163 for the case of only fatigue). In other words, the difference between the probability of occurrence of the most likely sequence and the probability of system failure is much larger for the case of two fatigue failures than for the case of a fatigue failure followed by a failure under an extreme wave. This is because the fatigue failures have low correlations while the failures under an extreme wave load are highly correlated. Note that in a more redundant structure which requires a larger number of element failures for overall collapse, the system failure probability for sequences of fatigue failures will greatly decrease (due to the low correlations of the fatigue failures). However, for such a redundant structure, the risk due to combined sequences (initial failure in fatigue and subsequent failures under an extreme wave) may not decrease because all the subsequent failures (under a single extreme wave) are highly correlated. Therefore, in more redundant structures, combined sequences of failures may be a much more significant source of risk.

References :

De, R.S., Karamchandani, A.K. and Cornell, C.A., "Offshore Structural System Reliability under Changing Load Pattern", Applied Ocean Research, 1991

Karamchandani, A.K., "Structural System Reliability Analysis Methods" Report No.83, John Blume Earthquake Engineering Center, Stanford, California, July 1987.

Karamchandani, A.K., Dalane, J.I. and Bjerager, P., - Systems reliability of offshore structures including fatigue and extreme wave loading", Journal of Marine Structures, 1991.

Karamchandani, A.K., Dalane, J.I. and Bjerager, P., "A Systems Reliability Approach to Fatigue of Structures", ASCE Journal of Structural Engineering, 1992.

Nordal, H., Karamchandani, A.K., and Cornell, C.A., "A System Reliability Case Study of an Eight-leg Jacket Platform", Technical Report RMS-3, Department of Civil Engineering, Stanford University, Stanford, California, April 1988.

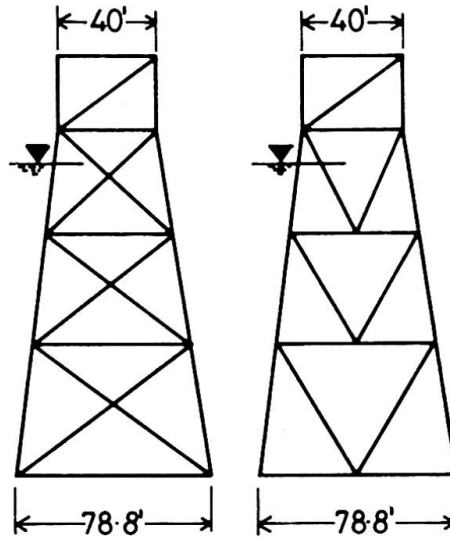
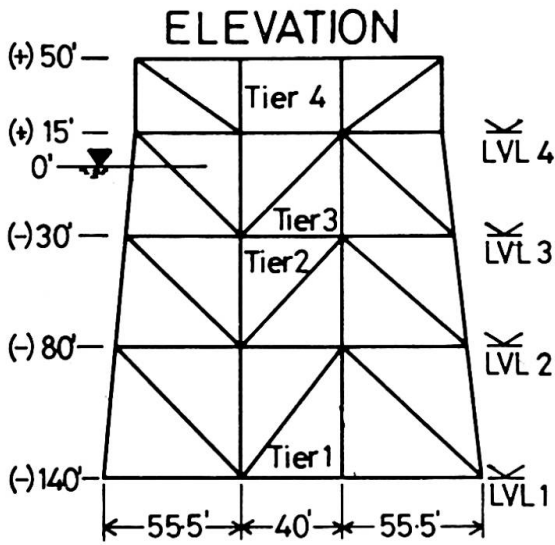

FIG 2: BENTS ALONG A, B, C, D

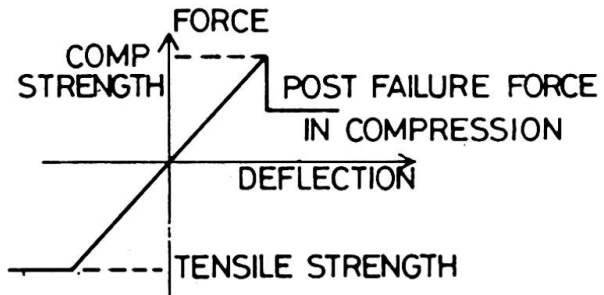
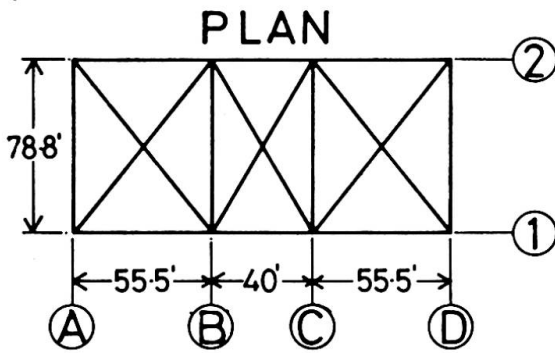

FIG 1: EIGHT LEGGED JACKED PLATFORM FIG 3: MEMBER FORCE DEFORMATION CURVES

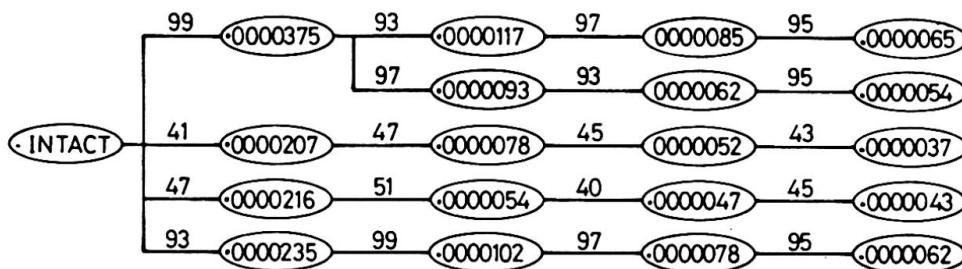

FIG 4: IMPORTANT SEQUENCES FOR THE X- CONFIGURATION

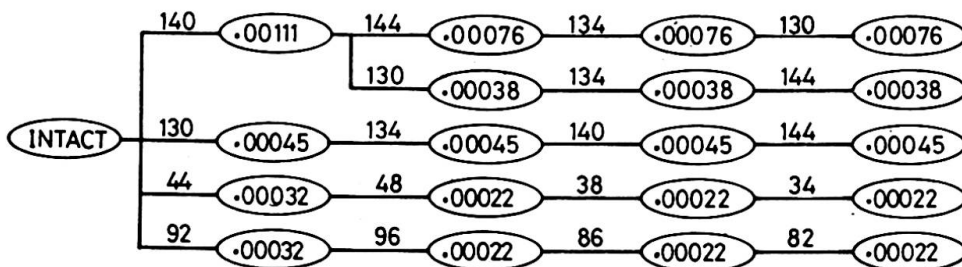

FIG 5: IMPORTANT SEQUENCES FOR THE K- CONFIGURATION

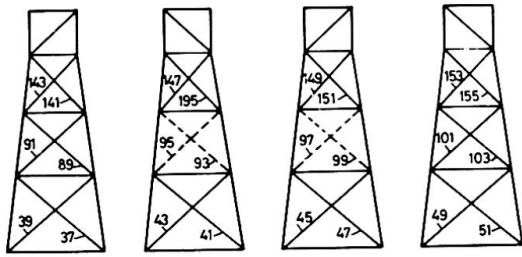

FIG. 6 CRITICAL ELEMENTS FOR ANALYSIS BASED ON 100 YEAR DESIGN WAVE

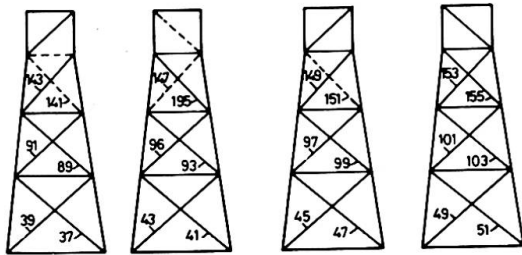

FIG. 7 CRITICAL ELEMENTS FOR ANALYSIS USING A VARIABLE WAVE LOAD PATTERN

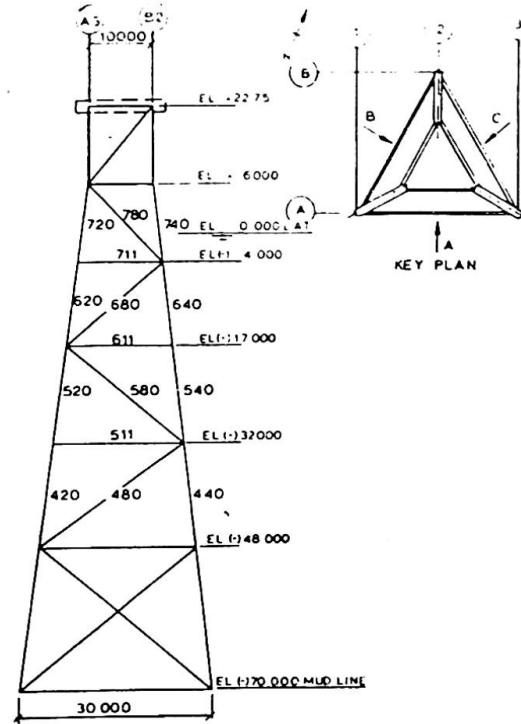
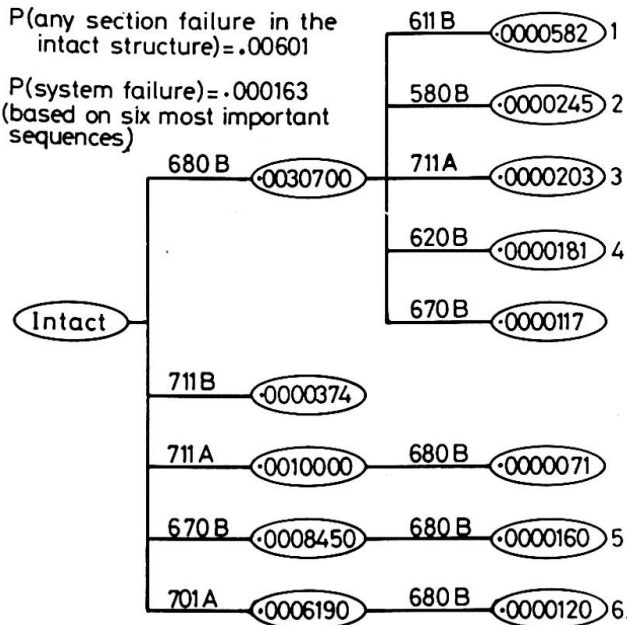
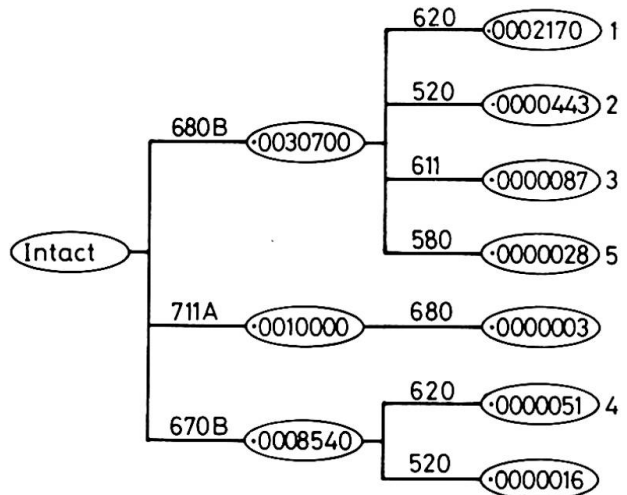

FIG. 8: TRIPOD JACKET PLATFORM



NOTE: The symbols A and B indicate the two ends of a member (e.g. 570 B is the section at end 'B' of member 570.)

Fig. 9 IMPORTANT SEQUENCES OF FAILURES IN FATIGUE.



$P(\text{system failure}) = .000234$
 (based on the five most important sequences)

Fig. 10 IMPORTANT SEQUENCES OF FAILURES UNDER FATIGUE AND EXTREME WAVES (ALL INITIAL FAILURES ARE IN FATIGUE AND SUBSEQUENT FAILURES ARE UNDER EXTREME WAVES)