

**Zeitschrift:** IABSE structures = Constructions AIPC = IVBH Bauwerke  
**Band:** 8 (1984)  
**Heft:** C-29: Structures in Canada

## **Werbung**

### **Nutzungsbedingungen**

Die ETH-Bibliothek ist die Anbieterin der digitalisierten Zeitschriften. Sie besitzt keine Urheberrechte an den Zeitschriften und ist nicht verantwortlich für deren Inhalte. Die Rechte liegen in der Regel bei den Herausgebern beziehungsweise den externen Rechteinhabern. [Siehe Rechtliche Hinweise.](#)

### **Conditions d'utilisation**

L'ETH Library est le fournisseur des revues numérisées. Elle ne détient aucun droit d'auteur sur les revues et n'est pas responsable de leur contenu. En règle générale, les droits sont détenus par les éditeurs ou les détenteurs de droits externes. [Voir Informations légales.](#)

### **Terms of use**

The ETH Library is the provider of the digitised journals. It does not own any copyrights to the journals and is not responsible for their content. The rights usually lie with the publishers or the external rights holders. [See Legal notice.](#)

**Download PDF:** 15.03.2025

**ETH-Bibliothek Zürich, E-Periodica, <https://www.e-periodica.ch>**

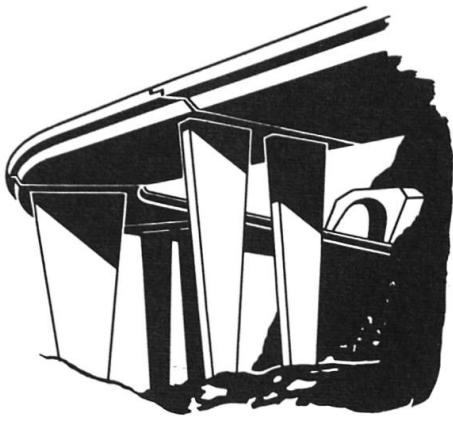

**Belags-Sickerwasser-Ableiter**

*Subsurface Seepage.  
Evacuations des eaux  
et aérations.*

*Ductos de agua de  
filtración para calzadas.*

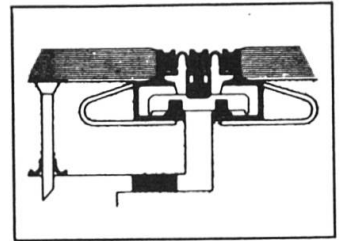

**Fahrbahn-Übergangs-Konstruktionen.**

*Expansion joints.*

**Raccordements de  
chausées**

*Sistemas de juntas  
de dilatación.*

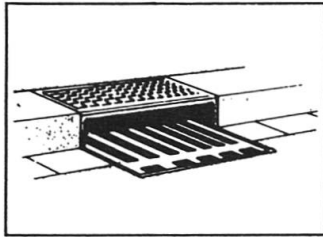

**Entwässerungs-Systeme**

*Surface drainage*

**Evacuations des eaux**

*Pozos de drenaje*

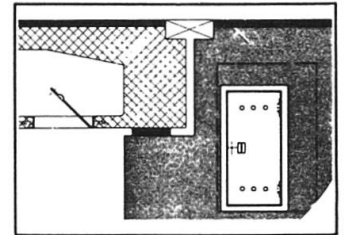
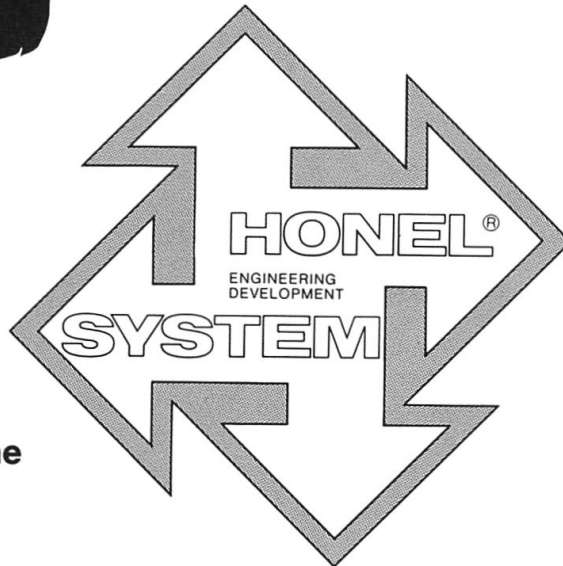

**Hohlraumschalungen  
Einstiegsluken + Türen**

*Formwork + Moulds*

*Access openings*

**Ouvertures d'entrée**

*Aberturas de entrada*

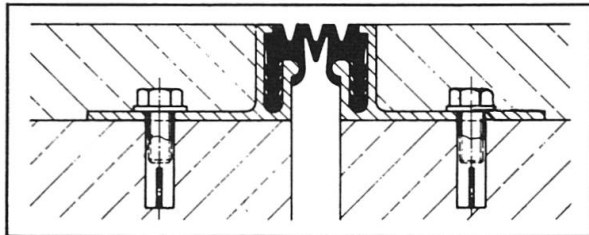

**Fugendichtungen im Hoch- + Tiefbau**

*Joint seals + Joint profilés*

**Sellos para juntas**

**Auflager**

*Structural*

*Bearings*

**Appuis**

*Apoyos*

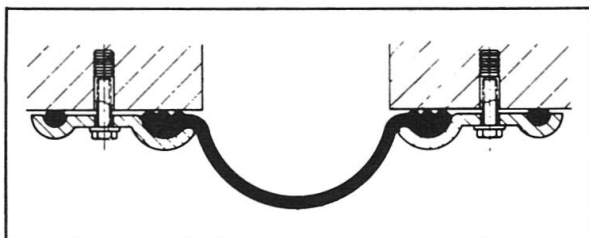
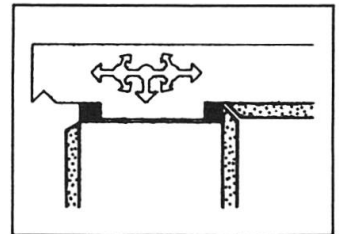

**Pressen + Pumpen**

*Hydraulic jacks*

**Verins + Pompes**

*Prensas + bombas*



**heinz honegger ag**

CH-8427 Rorbas ZH Switzerland  
Tel. 01 - 865 11 77, Telex 52844

**Vertretungs- und Lizenzvergabe:**

Honel-Holding SA  
Sonnstattstrasse 6  
CH-8180 Bülach, Switzerland  
Phone 01/860 89 43



**Programmed for highest economy:**

**the informatics theodolite for you.**



**Measure with highest precision**

With a standard deviation of 0.5" (0.15 mgon), the THEOMAT informatics theodolite has the most accurate angle-measuring system of all.

**Flexible to cope with any task**

The Wild T2000 offers limitless possibilities and its various measuring modes allow it to adapt easily to any task. With the DI4, DI4L and DI20 DISTOMATs, it forms an electronic tacheometer with high

performance and measuring speed. With the Wild GRE3 Data Terminal connected, the Wild T2000 transforms into a data-acquisition, data recording and field processing system that meets all demands.

**Maximum comfort for efficient, reliable working**

You can absolutely depend on your Wild T2000 to work even under the toughest climatic conditions (-20°C to +50°C). It powers and controls the DISTOMAT and GRE3, monitors all functions, and its central

control panel displays operating instructions and results.

**THEOMAT Wild T2000:  
the computer-age modular  
survey system.**

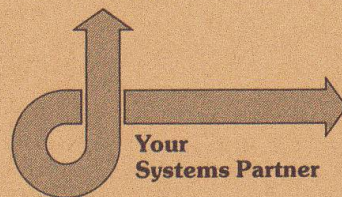

G 60/83

Wild Heerbrugg Ltd · CH-9435 Heerbrugg · Switzerland · Tel. 071/70 31 31

**WILD  
HEERBRUGG**

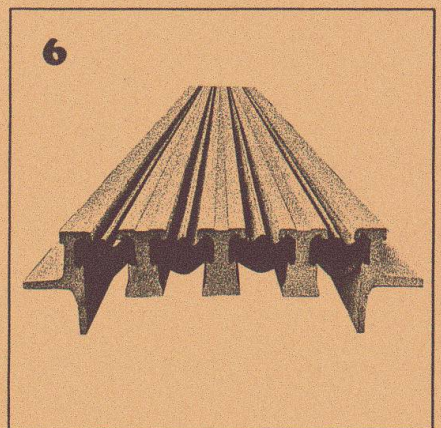
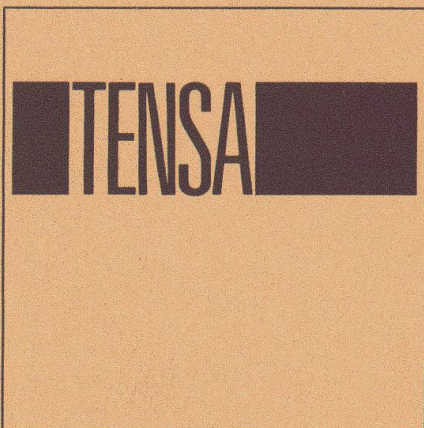
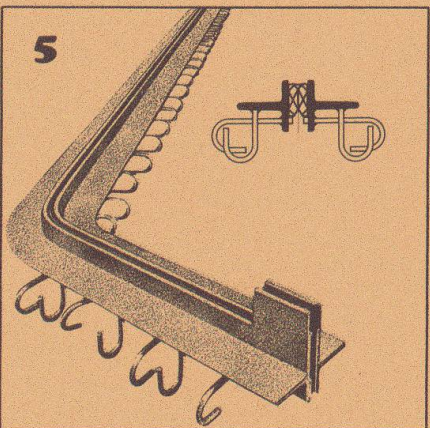
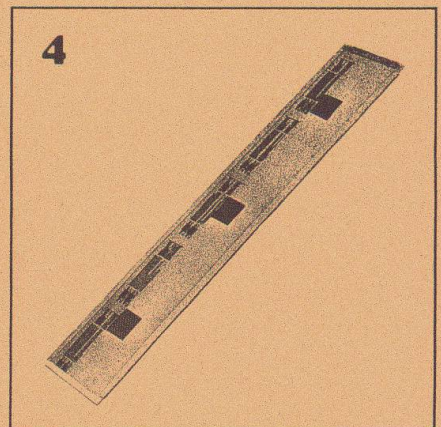
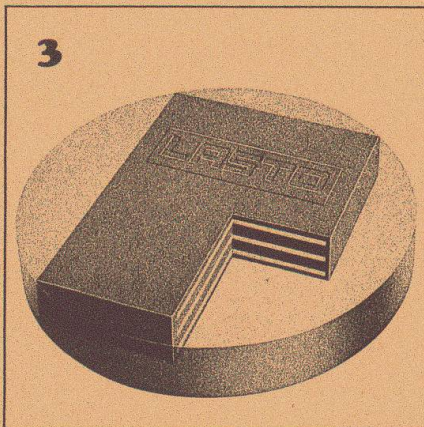
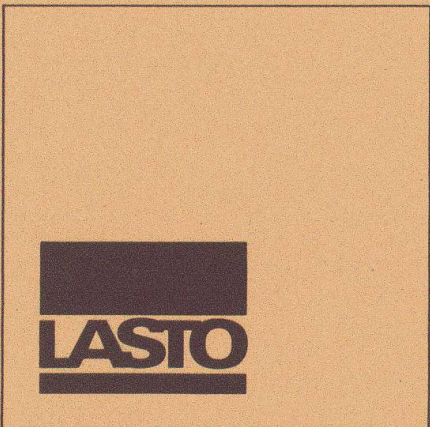
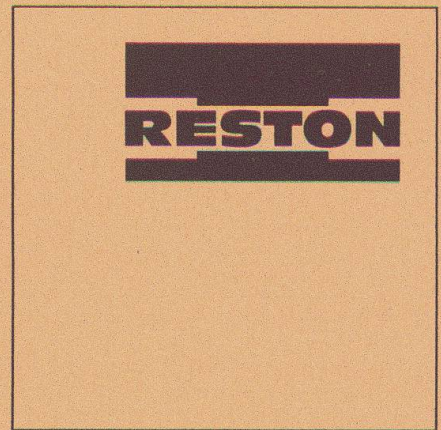
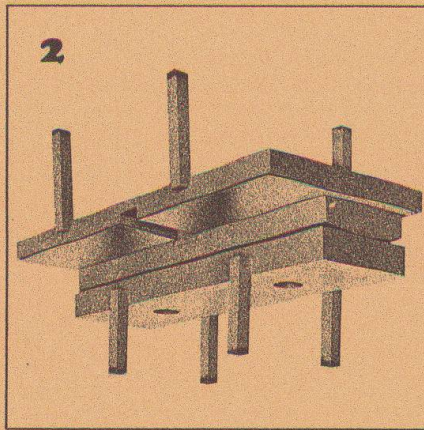
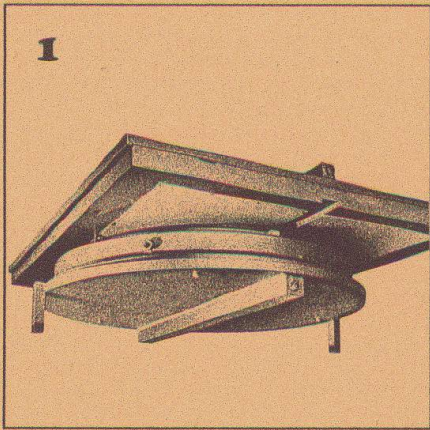

**1**  
**RESTON Pot Sliding Bearings** are highly suitable for installation in bridge structures. They feature a low-profile design, low weight and high loading capacity.

**2**  
**RESTON Linear Tilting and Sliding Bearings** are a combination of normal linear tilting bearings and PTFE sliding bearings and are suitable for installation in bridge structures.

**3**  
**LASTO-BLOCK Bearings** are suitable for building, civil engineering and bridge construction applications. Their simple form allows easy installation.

**4**  
**LASTO-STRIP Bearings for Buildings** were especially developed for building constructions. They are particularly suitable for movement compensation between concrete slabs and load-supporting walls and prevent structural cracking.

**5**  
**TENSA-ACME Roadway Construction Joints** are highly suitable for installation in traffic levels (parking lots, bridges, airport areas etc.). Dilatation up to 60 mm.

**6**  
**TENSA-LASTIC Roadway Construction Joints** meet all the requirements that can be made in bridge engineering of a modern joint design. They are rugged and watertight. Dilatation range 60 mm and bigger.

PROCEQ SA  
 Riesbachstrasse 57  
 CH-8034 Zurich

proceq

Phone: 01/47 78 00  
 Telex 53357 proce ch