

Objektyp: **Advertising**

Zeitschrift: **IABSE structures = Constructions AIPC = IVBH Bauwerke**

Band (Jahr): **8 (1984)**

Heft C-30: **Industrial cranes**

PDF erstellt am: **22.07.2024**

Nutzungsbedingungen

Die ETH-Bibliothek ist Anbieterin der digitalisierten Zeitschriften. Sie besitzt keine Urheberrechte an den Inhalten der Zeitschriften. Die Rechte liegen in der Regel bei den Herausgebern.

Die auf der Plattform e-periodica veröffentlichten Dokumente stehen für nicht-kommerzielle Zwecke in Lehre und Forschung sowie für die private Nutzung frei zur Verfügung. Einzelne Dateien oder Ausdrucke aus diesem Angebot können zusammen mit diesen Nutzungsbedingungen und den korrekten Herkunftsbezeichnungen weitergegeben werden.

Das Veröffentlichen von Bildern in Print- und Online-Publikationen ist nur mit vorheriger Genehmigung der Rechteinhaber erlaubt. Die systematische Speicherung von Teilen des elektronischen Angebots auf anderen Servern bedarf ebenfalls des schriftlichen Einverständnisses der Rechteinhaber.

Haftungsausschluss

Alle Angaben erfolgen ohne Gewähr für Vollständigkeit oder Richtigkeit. Es wird keine Haftung übernommen für Schäden durch die Verwendung von Informationen aus diesem Online-Angebot oder durch das Fehlen von Informationen. Dies gilt auch für Inhalte Dritter, die über dieses Angebot zugänglich sind.

“NLM-KIC-831” SAFETY IS THE BEST POLICY “NLM-RIC-821”

— The Best Device for Maintenance of Bridge Deck, Shoe ……

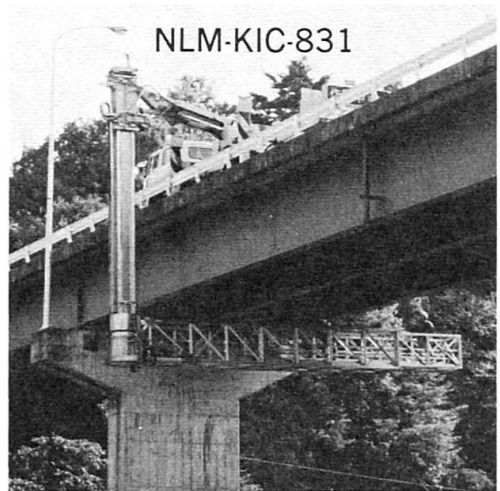
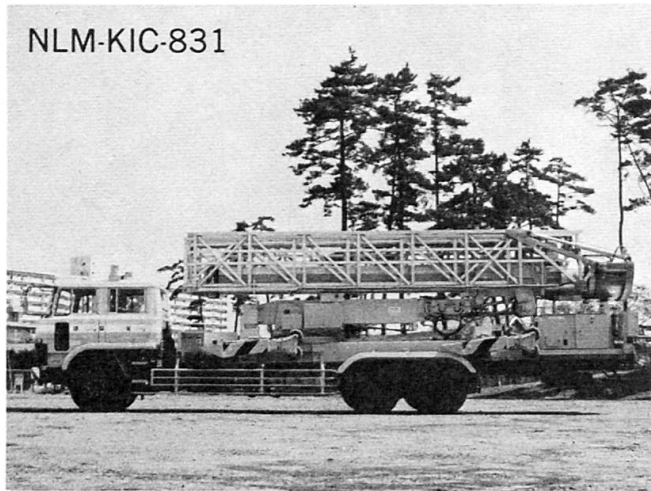

NLM-KIC-831, New Truck-mounted Telescopic Platform Type, Developed in Close Cooperation with Japan's Ministry of Construction

- Economy, with a lightweight aluminium alloy vertical boom and telescopic platform
- Efficiency, with an optional aluminium lifter for closer inspection

NLM-RIC-821, Trolley Traveller Type Running on Special Tracks under Bridge Girder, Aluminium Alloy Made



ENGINEERING FORERUNNER OF BRIDGE INSPECTION EQUIPMENT



NIPPON LIGHT METAL COMPANY, LTD.

Public Utilities Engineering Div.

No. 3-5, Ginza 7-chome Chuo-ku, Tokyo, Japan

Tel: Tokyo 03-574-3876, 3881 Telex: 252-4697 NLMCO J

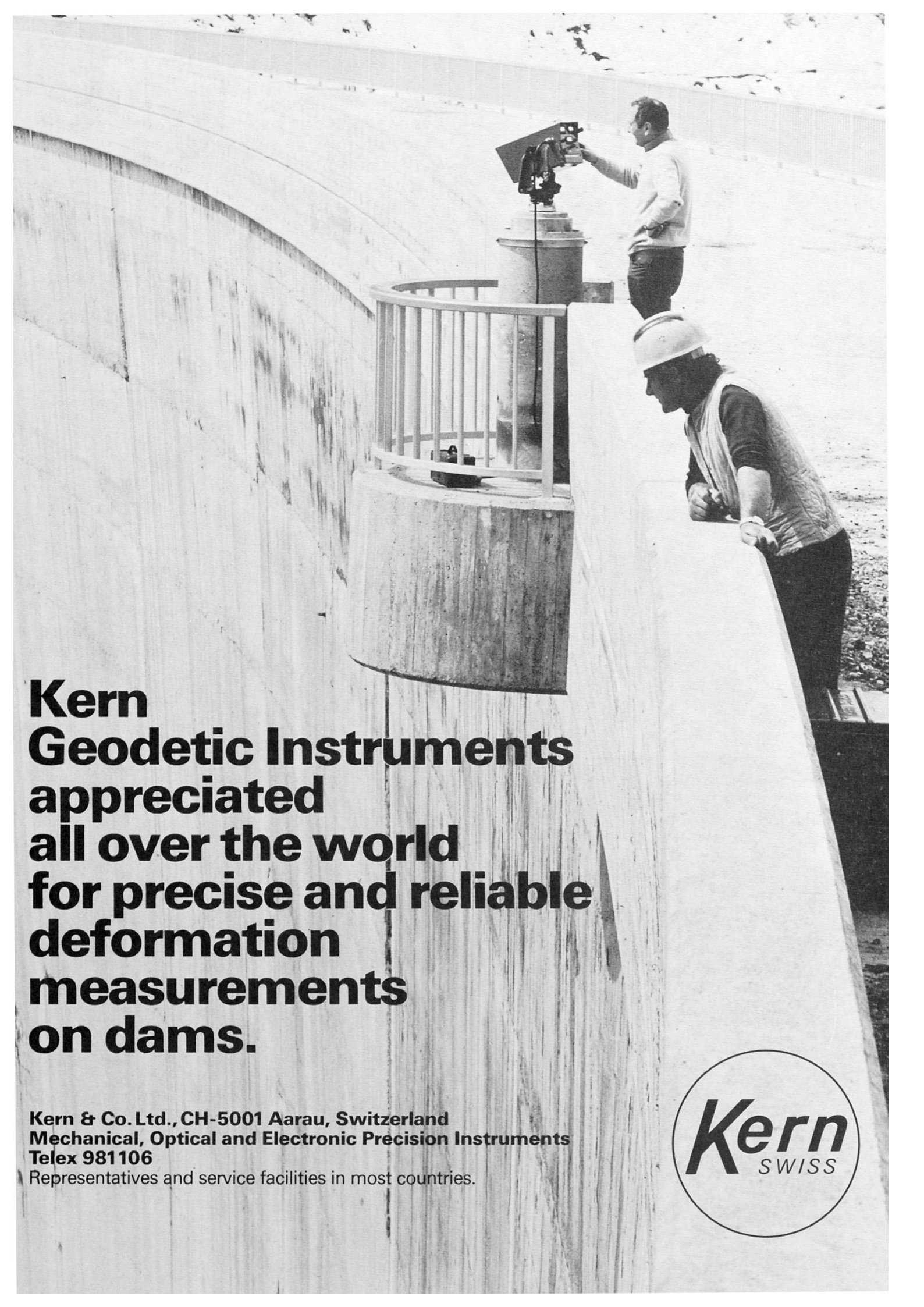

**Kern
Geodetic Instruments
appreciated
all over the world
for precise and reliable
deformation
measurements
on dams.**

**Kern & Co. Ltd., CH-5001 Aarau, Switzerland
Mechanical, Optical and Electronic Precision Instruments
Telex 981106**

Representatives and service facilities in most countries.



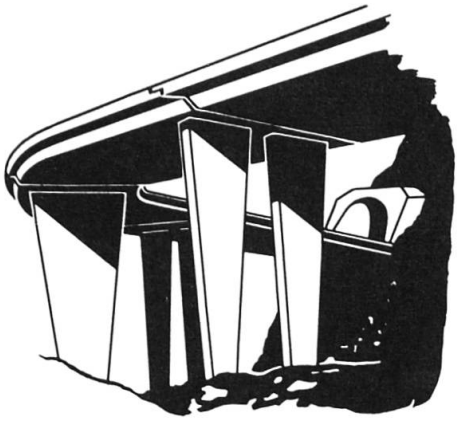

**Belags-Sickerwasser-
Ableiter**
Subsurface Seepage.
**Evacuations des eaux
et aérations.**
*Ductos de agua de
filtración para calzadas.*

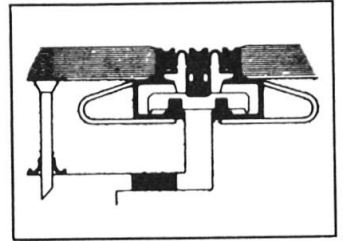

**Fahrbahn-Übergangs-
Konstruktionen.**
Expansion joints.
**Raccordements de
chausées**
*Sistemas de juntas
de dilatación.*

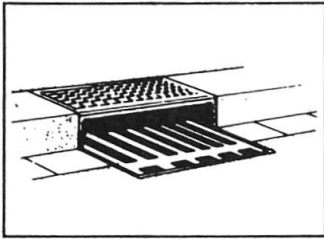

Entwässerungs-Systeme
Surface drainage
Evacuations des eaux
Pozos de drenaje

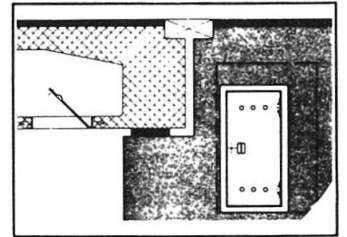
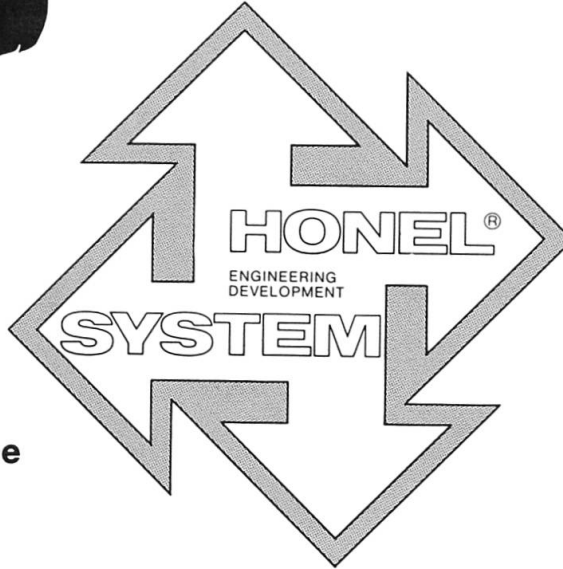

**Hohlraumschalungen
Einstiegsluken + Türen**
Formwork + Moulds
Access openings
Ouvertures d'entrée
Aberturas de entrada

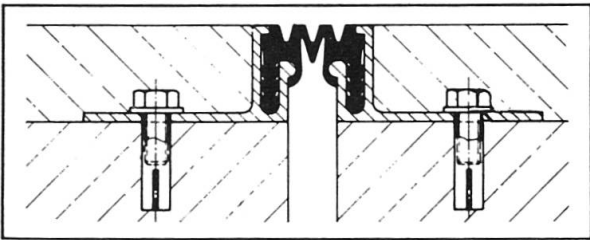

Fugendichtungen im Hoch- + Tiefbau
Joint seals + Joint profilés
Sellos para juntas

Auflager
*Structural
Bearings*
Appuis
Apoyos

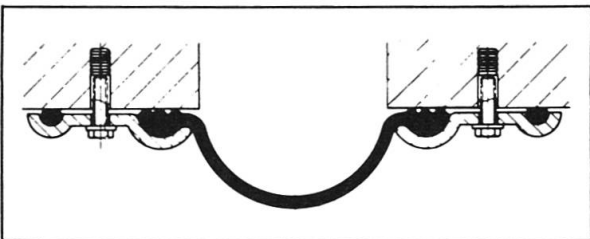
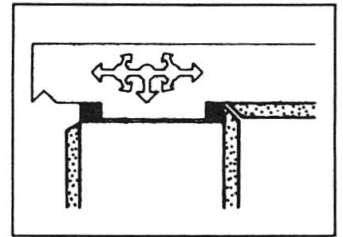

Pressen + Pumpen
Hydraulic jacks
Verins + Pompes
Prensas + bombas



heinz honegger ag

CH-8427 Rorbas ZH Switzerland
Tel. 01 - 865 11 77, Telex 52844

Vertretungs- und Lizenzvergabe:
Honel-Holding SA
Sonnstattstrasse 6
CH-8180 Bülach, Switzerland
Phone 01/860 89 43



Accurate to 3mm + 2ppm, range up to 5 km

The new Wild DI5 DISTOMAT

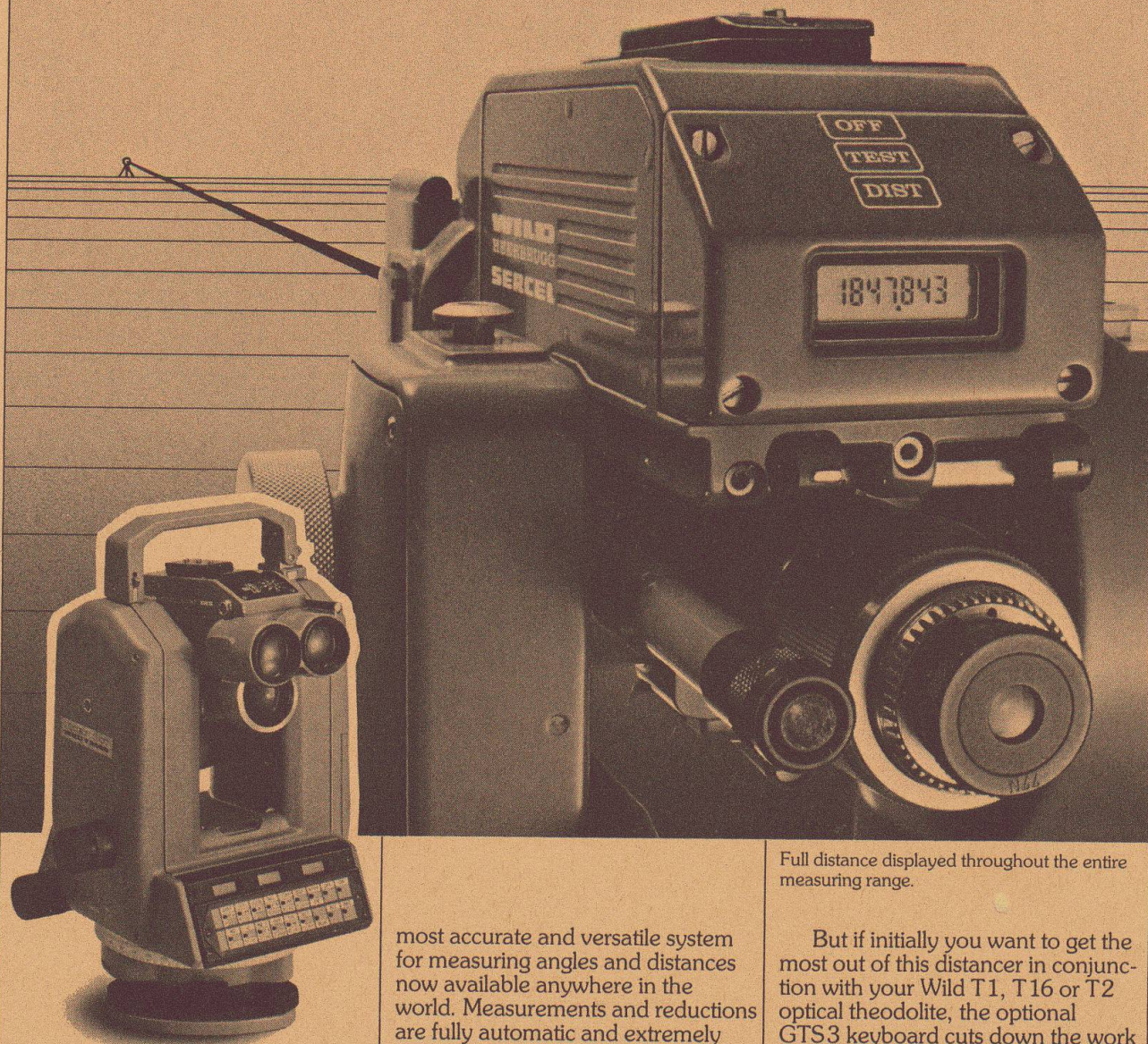

The Wild DI5 DISTOMAT is the latest addition to the leading Wild modular system, handy in size and exceptionally efficient. Its special features are long range, the high accuracy of 3 mm + 2 ppm and remarkable operating convenience.

Combined with the Wild T2000 Informatix Theodolite it forms the

most accurate and versatile system for measuring angles and distances now available anywhere in the world. Measurements and reductions are fully automatic and extremely fast.

The GRE3 data terminal has full field capability and relieves you of the need to book field data. Connected to the T2000/DI5 it can do your field calculations using your own programs. In the office you can process your data in your computer system by connecting it via an RS232 interface.

Full distance displayed throughout the entire measuring range.

But if initially you want to get the most out of this distancer in conjunction with your Wild T1, T16 or T2 optical theodolite, the optional GTS3 keyboard cuts down the work of reductions and computations. And if the DI5 is not what you want, why not look at the Wild DI4, DI4L and DI20 DISTOMATs?

The best thing you can do is to send for detailed documentation right away! ■

G 67/83

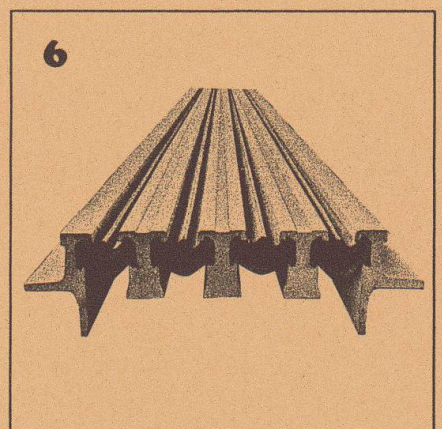
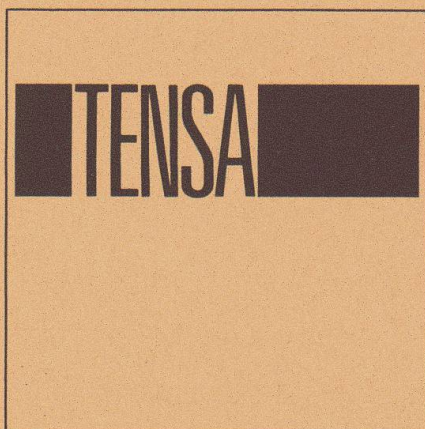
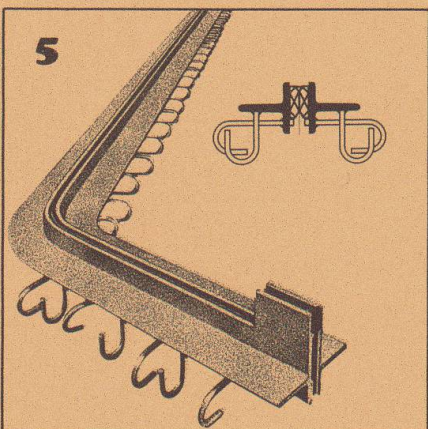
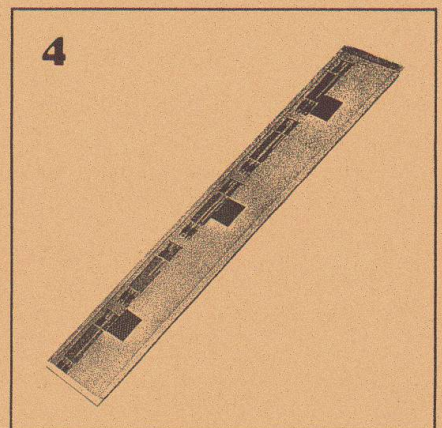
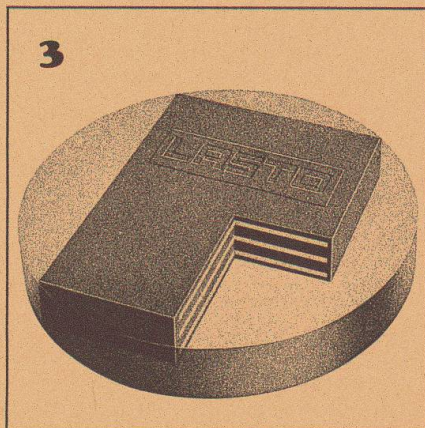
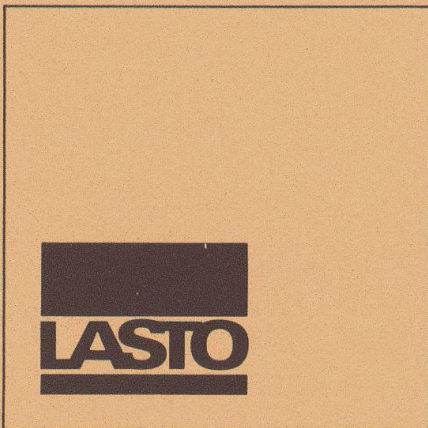
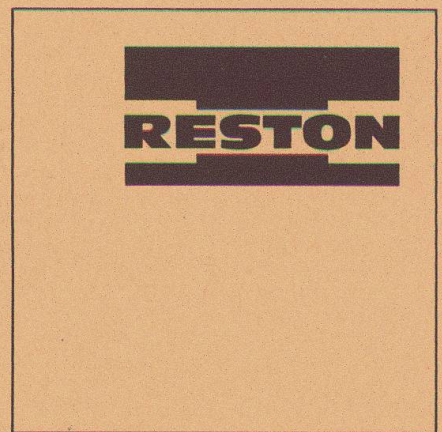
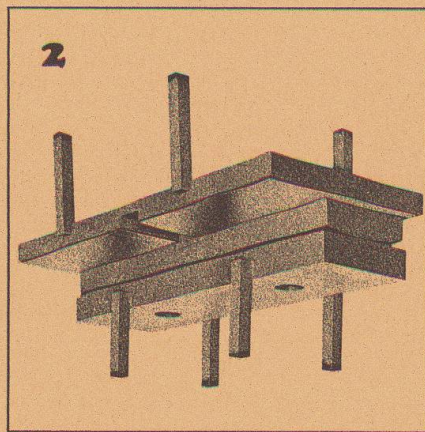
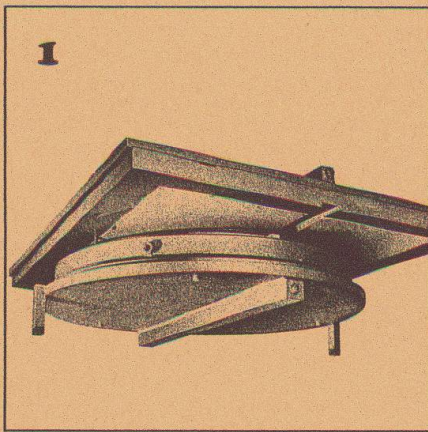

1
RESTON Pot Sliding Bearings are highly suitable for installation in bridge structures. They feature a low-profile design, low weight and high loading capacity.

2
RESTON Linear Tilting and Sliding Bearings are a combination of normal linear tilting bearings and PTFE sliding bearings and are suitable for installation in bridge structures.

3
LASTO-BLOCK Bearings are suitable for building, civil engineering and bridge construction applications. Their simple form allows easy installation.

4
LASTO-STRIP Bearings for Buildings were especially developed for building constructions. They are particularly suitable for movement compensation between concrete slabs and load-supporting walls and prevent structural cracking.

5
TENSA-ACME Roadway Construction Joints are highly suitable for installation in traffic levels (parking lots, bridges, airport areas etc.). Dilatation up to 60 mm.

6
TENSA-LASTIC Roadway Construction Joints meet all the requirements that can be made in bridge engineering of a modern joint design. They are rugged and watertight. Dilatation range 60 mm and bigger.

PROCEQ SA
 Riesbachstrasse 57
 CH-8034 Zurich

proceq

Phone: 01/47 7800
 Telex 53357 proce ch