

Objektyp: **Advertising**

Zeitschrift: **IABSE structures = Constructions AIPC = IVBH Bauwerke**

Band (Jahr): **8 (1984)**

Heft C-31: **Storage tanks**

PDF erstellt am: **22.07.2024**

Nutzungsbedingungen

Die ETH-Bibliothek ist Anbieterin der digitalisierten Zeitschriften. Sie besitzt keine Urheberrechte an den Inhalten der Zeitschriften. Die Rechte liegen in der Regel bei den Herausgebern.

Die auf der Plattform e-periodica veröffentlichten Dokumente stehen für nicht-kommerzielle Zwecke in Lehre und Forschung sowie für die private Nutzung frei zur Verfügung. Einzelne Dateien oder Ausdrucke aus diesem Angebot können zusammen mit diesen Nutzungsbedingungen und den korrekten Herkunftsbezeichnungen weitergegeben werden.

Das Veröffentlichen von Bildern in Print- und Online-Publikationen ist nur mit vorheriger Genehmigung der Rechteinhaber erlaubt. Die systematische Speicherung von Teilen des elektronischen Angebots auf anderen Servern bedarf ebenfalls des schriftlichen Einverständnisses der Rechteinhaber.

Haftungsausschluss

Alle Angaben erfolgen ohne Gewähr für Vollständigkeit oder Richtigkeit. Es wird keine Haftung übernommen für Schäden durch die Verwendung von Informationen aus diesem Online-Angebot oder durch das Fehlen von Informationen. Dies gilt auch für Inhalte Dritter, die über dieses Angebot zugänglich sind.



**Belags-Sickerwasser-
Ableiter**
Subsurface Seepage.
**Evacuacions des eaux
et aérations.**
*Ductos de agua de
filtración para calzadas.*

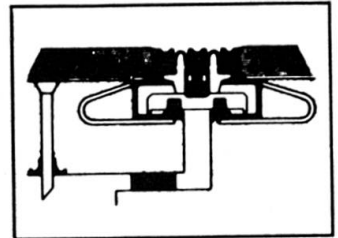

**Fahrbahn-Übergangs-
Konstruktionen.**
Expansion joints.
**Raccordements de
chausées**
*Sistemas de juntas
de dilatación.*

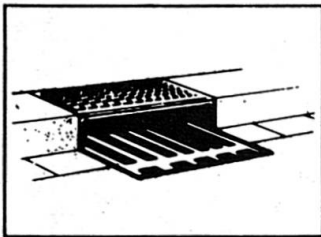

Entwässerungs-Systeme
Surface drainage
Evacuacions des eaux
Pozos de drenaje

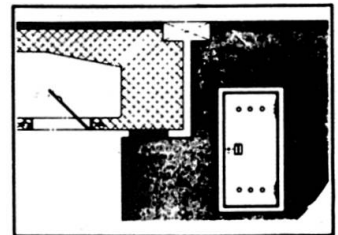
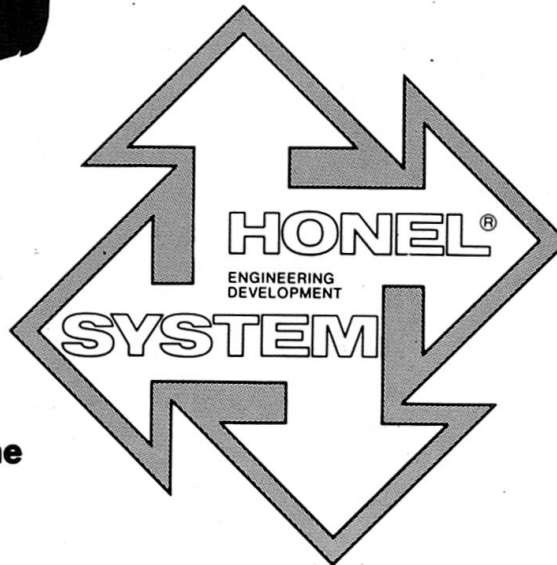

Hohlraumschalungen
Einstiegsluken + Türen
Formwork + Moulds
Access openings
Ouvertures d'entrée
Aberturas de entrada

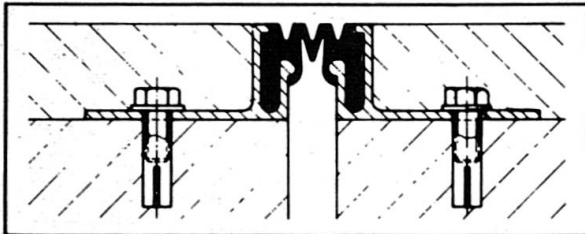

Fugendichtungen im Hoch- + Tiefbau
Joint seals + Joint profilés
Sellos para juntas

Auflager
Structural
Bearings
Appuis
Apoyos

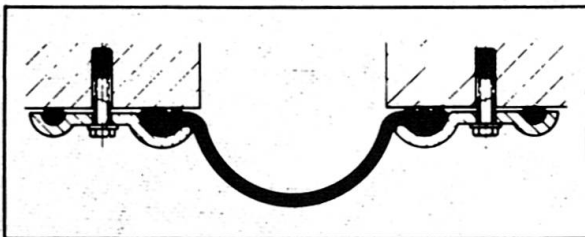
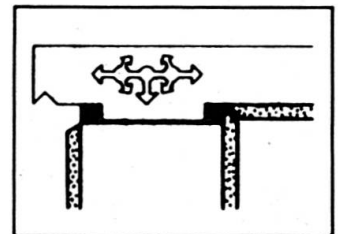

Pressen + Pumpen
Hydraulic jacks
Verins + Pompes
Prensas + bombas



heinz honegger ag

CH-8427 Rorbas ZH Switzerland
Tel. 01 - 865 11 77, Telex 52844

Vertretungs- und Lizenzvergabe:

Honel-Holding SA
Sonnemattstrasse 6
CH-8180 Bülach, Switzerland
Phone 01/860 89 43



First-order evolution in geodesy and industry

Modern technology has come up with a new precision level, the **Wild N3**, designed to bring the highest accuracy to the most varied tasks: first-order levelling for geodetic control, deformation measurements, determining subsidence and monitoring crustal movements. It's perfect too for industry and laboratories: for checking, aligning and positioning machinery, and for measuring inclinations.

The powerful **panfocal telescope** has over $40\times$ magnification at normal sighting distances, yet it will focus to a scale **only 30 cm (12 inches)** from the objective. The field of view widens at short distances. And it's an alignment telescope with remarkable stability of the line of sight.

With the calibrated tilting screw, small angles and changes in inclination can be measured with micro-

meter accuracy for optical tooling purposes as well as for river crossings in geodesy. The autocollimation eyepiece converts the N3 into an autocollimation instrument; the laser eyepiece transforms it into a laser level.

The **Wild N3** is an ultra-modern precision level. From its predecessor it has inherited its unmatched accuracy – a standard deviation of ± 0.2 mm for 1 km double run levelling – and its absolute reliability.

For colour brochure Wild N3

Send this coupon to your next Wild representative or directly to Wild Heerbrugg Ltd., CH-9435 Heerbrugg, Switzerland.

Name

Company

Address

Wild Heerbrugg Ltd.
CH-9435 Heerbrugg, Switzerland

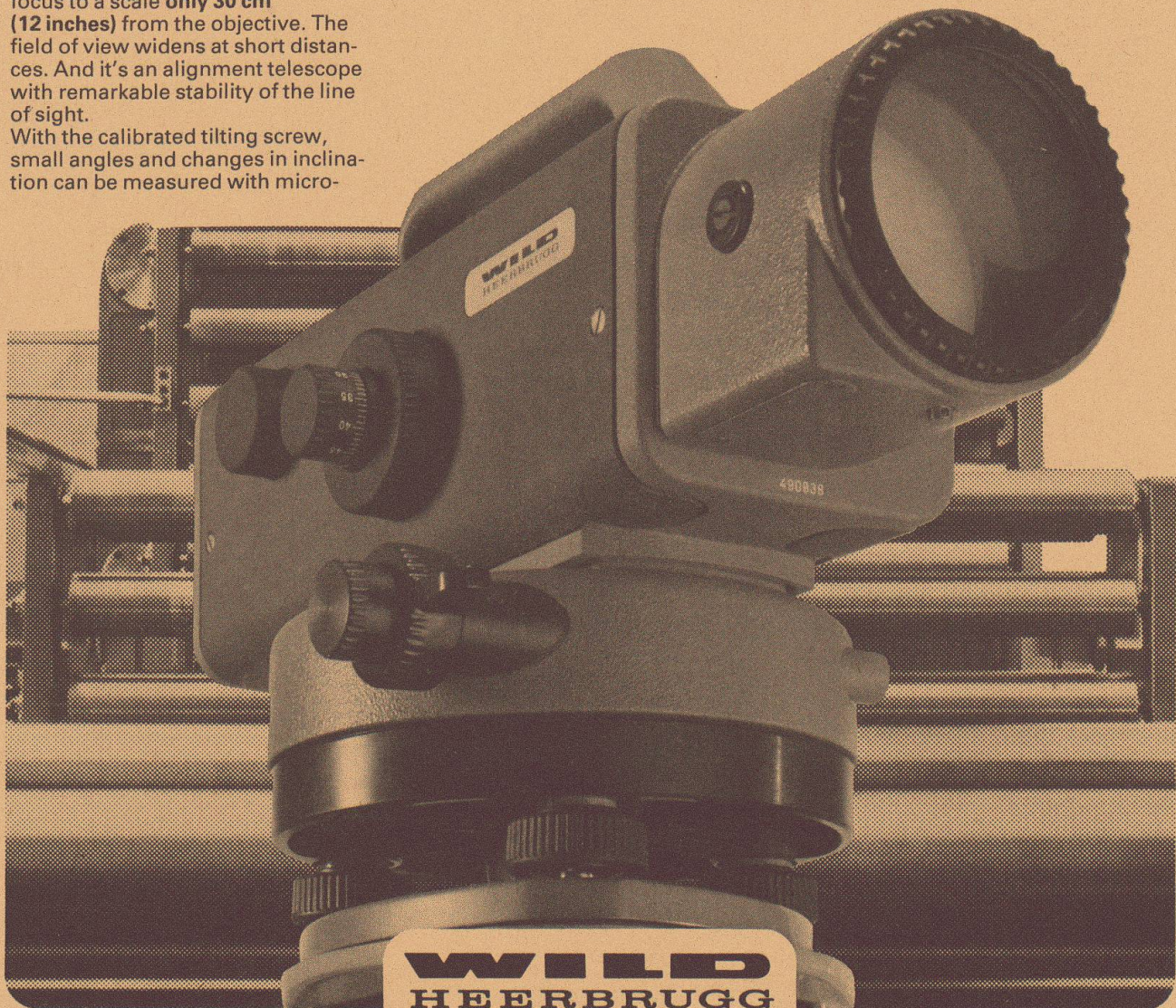

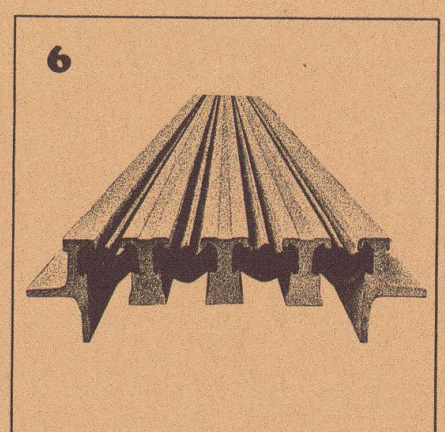
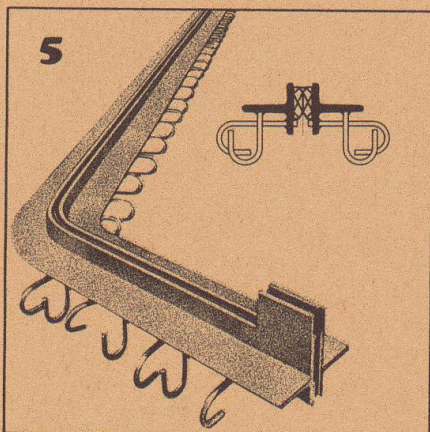
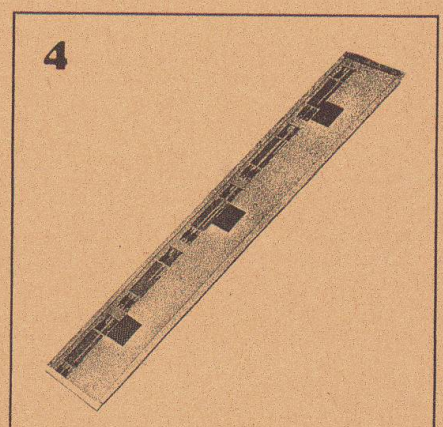
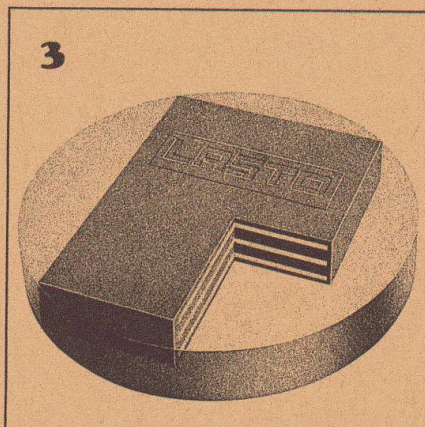
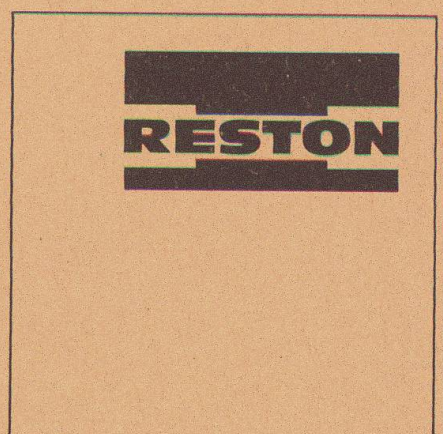
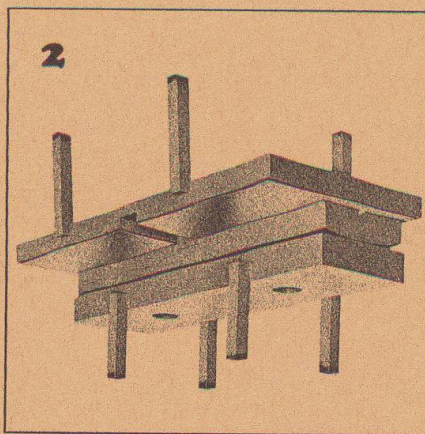
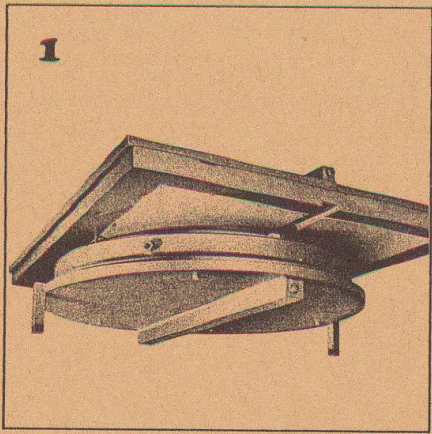

1
RESTON Pot Sliding Bearings are highly suitable for installation in bridge structures. They feature a low-profile design, low weight and high loading capacity.

2
RESTON Linear Tilting and Sliding Bearings are a combination of normal linear tilting bearings and PTFE sliding bearings and are suitable for installation in bridge structures.

3
LASTO-BLOCK Bearings are suitable for building, civil engineering and bridge construction applications. Their simple form allows easy installation.

4
LASTO-STRIP Bearings for Buildings were especially developed for building constructions. They are particularly suitable for movement compensation between concrete slabs and load-supporting walls and prevent structural cracking.

5
TENSA-ACME Roadway Construction Joints are highly suitable for installation in traffic levels (parking lots, bridges, airport areas etc.). Dilatation up to 60 mm.

6
TENSA-LASTIC Roadway Construction Joints meet all the requirements that can be made in bridge engineering of a modern joint design. They are rugged and watertight. Dilatation range 60 mm and bigger.

PROCEQ SA
 Riesbachstrasse 57
 CH-8034 Zurich

proceq

Phone: 01/47 7800
 Telex 53357 proce ch