

Review of management information systems in construction

Autor(en): **O'Brien, Jonathan**

Objektyp: **Article**

Zeitschrift: **IABSE journal = Journal AIPC = IVBH Journal**

Band (Jahr): **13 (1989)**

Heft J-38: **Review of management information systems in construction**

PDF erstellt am: **21.07.2024**

Persistenter Link: <https://doi.org/10.5169/seals-30918>

Nutzungsbedingungen

Die ETH-Bibliothek ist Anbieterin der digitalisierten Zeitschriften. Sie besitzt keine Urheberrechte an den Inhalten der Zeitschriften. Die Rechte liegen in der Regel bei den Herausgebern.

Die auf der Plattform e-periodica veröffentlichten Dokumente stehen für nicht-kommerzielle Zwecke in Lehre und Forschung sowie für die private Nutzung frei zur Verfügung. Einzelne Dateien oder Ausdrucke aus diesem Angebot können zusammen mit diesen Nutzungsbedingungen und den korrekten Herkunftsbezeichnungen weitergegeben werden.

Das Veröffentlichen von Bildern in Print- und Online-Publikationen ist nur mit vorheriger Genehmigung der Rechteinhaber erlaubt. Die systematische Speicherung von Teilen des elektronischen Angebots auf anderen Servern bedarf ebenfalls des schriftlichen Einverständnisses der Rechteinhaber.

Haftungsausschluss

Alle Angaben erfolgen ohne Gewähr für Vollständigkeit oder Richtigkeit. Es wird keine Haftung übernommen für Schäden durch die Verwendung von Informationen aus diesem Online-Angebot oder durch das Fehlen von Informationen. Dies gilt auch für Inhalte Dritter, die über dieses Angebot zugänglich sind.

Review of Management Information Systems in Construction

Revue des systèmes de gestion de l'information dans la construction

Management-Informationssysteme bei Bauarbeiten – Ein Überblick

Jonathan O'BRIEN

School of Civil Engineering
University of N.S.W.
Sydney, Australia



J.B. O'Brien received his B.E. degree in Civil Engineering from the University of N.S.W. and his M.E. from the Univ. of Toronto. He is an active researcher in the broad field of construction technology and management. He has a special interest in engineering problem solving and the development of high-level management skills.

SUMMARY

Recent times have seen a growing realisation of the importance of information as a resource in decision making and management. This has created a serious interest in the topic of management information systems. This paper develops a theory of such systems. It then critically examines the extent to which the construction management field, worldwide, is aware of, or has used, these ideas.

RÉSUMÉ

L'information prend une importance toujours plus grande dans le processus de décision et dans la gestion. Il en résulte un intérêt croissant pour les systèmes de gestion de l'information. L'article propose une théorie pour de tels systèmes. Il examine dans quelle mesure l'industrie internationale de la construction est informé de ces développements, ou les a déjà mis en application.

ZUSAMMENFASSUNG

In neuerer Zeit erkennt man immer mehr die Bedeutung der Information als Hilfsmittel bei Entscheidungsprozessen und im Management. Dies hat zu einem steigendem Interesse am Thema Management-Informationssysteme geführt. Dieser Beitrag zeigt die Theorie eines solchen Systems auf. Darauf folgt eine kritische Untersuchung inwieweit diese Ideen im Bereich des Bau-Managements schon bekannt oder bereits zur Anwendung gelangt sind.



1. INTRODUCTION

From a historical perspective, technological development in our society has largely resulted from people discovering new ways of looking at old things or developing new analytic frameworks or languages for discussing known phenomena and processes. Thus, in our time, "the systems viewpoint" or "the systems way of thinking" about problems has yielded new insight into old problems and has produced tools that have permitted the design of complex machines such as rockets. The phrase "all systems go" is now well known to all who have followed manned space flight. This system's viewpoint coupled with the emergent technologies of computers and telecommunications systems has resulted in the development of new sets of ideas which have proven most fruitful of new theories, insights and commercial products and services.

Given that these conceptions are now widely known in the general community it is to be expected that various workers in the field of general management and construction management will try to apply these notions to their specialist fields. In particular, over the last decade or so, there has been a boom in the general management field of articles and books on management information systems which is the topic of this article. So much activity has occurred that the shorthand notation M.I.S. is now commonly encountered in the literature. It stands for "Management Information System". In the construction field, there is also a trend to discussion of information and information related topics. Additionally, the terms management information system and M.I.S have in the last few years been cropping up with increased frequency as concepts diffuse across fields of knowledge.

2. OBJECTIVES

The aim of this paper is to review the attempts being made by construction practitioners and theorists to apply MIS concepts to their craft and generally to make an appraisal of the current state-of-the-art in this field. More specifically, the first object of this paper is to survey current knowledge in this emerging field and to collect and collate papers on this topic. Secondly, it has the object of systematising, organising and critically reviewing the various works and ideas collected and trying to place them in some kind of organising framework.

3. DECISION SUPPORT SYSTEMS

Allied to the emergent trend of M.I.S. there exists another concurrent trend to the development of an extensive set of ideas and notions relating to decision support systems. This may be considered the obverse face of M.I.S. There is, however, some subtle differences in perception that arise from adoption of one or other of these frames of reference. Decision support systems are discussed in more detail later on in this article.

4. LAYOUT OF THIS REPORT

This report is presented in four parts. Section A looks at the philosophy of the topic and develops some fundamental organising concepts and ideas. Section B reviews the general management literature whilst Section C reviews the specialist construction management literature. Section D presents overall conclusions.

SECTION A - THE THEORY OF MANAGEMENT INFORMATION SYSTEMS

1. HISTORICAL BACKDROP

Before the ideas of management, information and systems can be used appropriately, it is necessary to place these ideas against their history and against the stream of contemporary thought.

These ideas generally evolved from an amalgamation of the ideas of:-

- * Claude Shannon whose specific concept of information revolutionised the telecommunication field in the late 1930 - early 40's.
- * The work of Norbert Wiener in Cybernetics.
- * The work of Newell & Simon in the field of human problem solving and artificial intelligence in the 1970's.
- * The work of such people as Von Bertalanffy, Churchman and Emery in the field of systems theory in the 1950-1960's.

- * The work of Herbert Simon on decision making processes in management and organisations beginning in the late 1940's.
- * Workers in the E.D.P. fields from the late 1950's.
- * Workers in the field of computer science largely from 1960 onward.

2. CONCEPTUAL PROBLEMS

A preliminary skirmish with the extensive literature on M.I.S. reveals much muddled thinking, superficiality and conceptual confusion amongst writers. The field appears a virtual tower of Babel with each writer having his own conception of an M.I.S. At one extreme we have writers claiming M.I.S. to be synonymous with E.D.P. equipment (eg. Brookes 1982). On another extreme, M.I.S. is a functional unit in a business firm similar to accounting or purchasing (Murdick et al). Others yet again take M.I.S. to be synonymous with complex computer systems such as airline reservation systems and defence early warning systems (Thierauf 1975). Yet, others take M.I.S. to be a common corporate data base (Thierauf p.19). On a totally different plane, we have writers who view M.I.S. as the total intelligence system (used in the military sense) used by managers in their work (eg. Simon 1977, Churchman 1968). These various conceptions are portrayed graphically in figure 1.

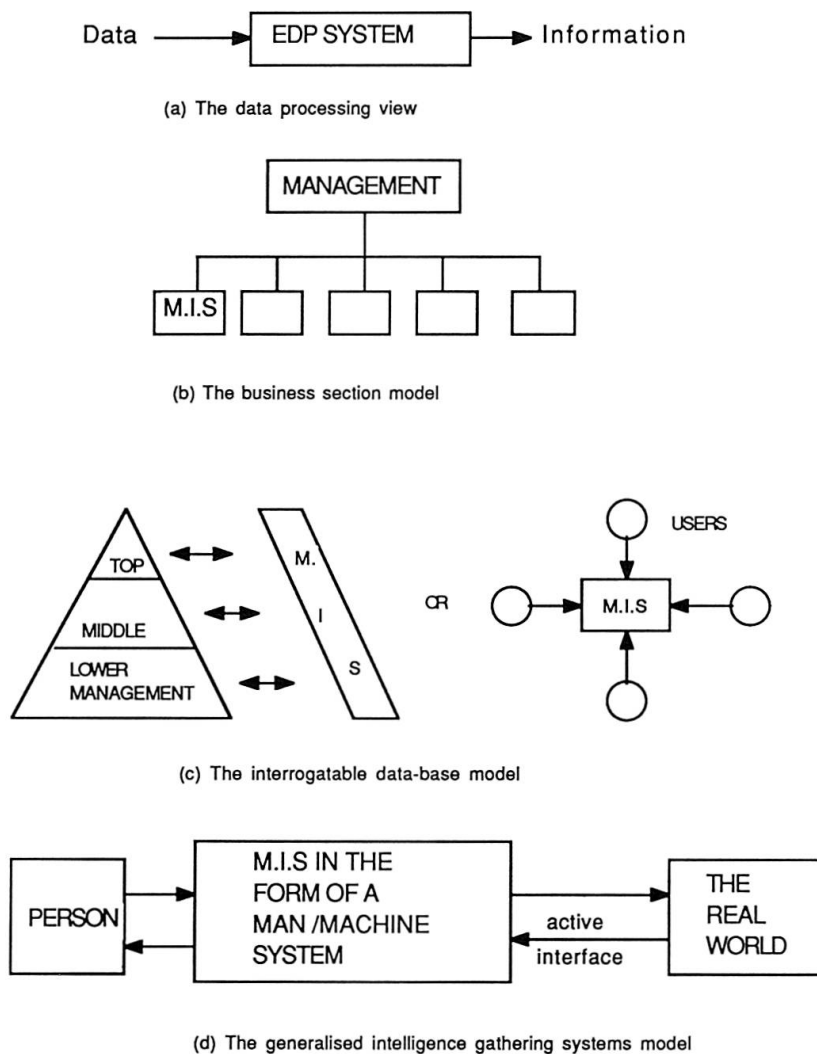

Figure 1. Varying Conceptions of M.I.S.'s

3. CLARIFICATION OF CONCEPTS

To make any sense out of the above diversity, it has been found necessary to re-examine some fundamental issues and develop an internally consistent definitions of the word "information



system". Without clear definitions of terms much effort can be lost in semantic debate and great confusion can result from the mixing of concepts. To determine exactly what a M.I.S. might be, it is necessary to clarify or define:-

- What information is?
- What a system is?
- What an information system is?
- What management might be?

3.1 PROBLEM NUMBER 1 - WHAT IS INFORMATION?

This question has perplexed scientists and philosophers for centuries. It is not the place here to discuss this problem in detail, suffice to say that these exist at least 3 violently different conceptions which, if not clearly distinguished, cause utter confusion. These are:-

1. The information theory - Shannon/Weaver Mathematical Science of Communication sense.
2. The question, answer, knowledge, semantics sense.
3. The E.D.P. sense. i.e. information is processed data.

This paper basically adopts the Shannon/Weaver definition of information because of its universality and rigorous conceptual base.

3.2 PROBLEM NUMBER 2 - WHAT IS A SYSTEM?

The concept of a system is related to the psychological concept of a "Gestalt". It is a set of elements with some perceived relationship between them. This relationship may be in the mind. The concept of "system" as used here is explored in detail in Emery F. ed "Systems Thinking" Penguin, Vol. I and II. In a nutshell, systems thinking relates to specific ways of looking at and organising the world. Systems thinking is a little bit like beauty however. It is in the eye of the beholder.

3.3 PROBLEM NUMBER 3 -WHAT IS AN INFORMATION SYSTEM?

3.3.1 GENERAL

It is not possible within the confines of this paper to fully develop the theory of information systems, suffice it to say that a rigorous argument exists for the conception of an information system as being an example of functional thinking in human beings (Freeman P. and Newell " A Model for Functional Reasoning in Design " Proc. 2nd Intl. Conf. on Artificial Intelligence London 1971.). Logically, I.S's are a class of objects, things, ideas categorised as having a commonality of function. They are systems designed to answer questions. They are analogous to the class of devices called "transducers", "timers" or "locks". Thus the term I.S. is a class name. Members of the class are specific technological devices which are concrete realisable objects. They can be defined by ostensive or operational definition.

Some feeling for the idea of a functional information system may be developed by consideration of the diverse set of objects represented by:

- The medical X-ray process.
- Directory assistance on the telephone.
- A national census.
- The weather bureau.
- The instruments and gauges in an airplane.
- The human sensory system.
- T.V. and newspapers.
- A carrier pigeon.
- A stock exchange ticker tape machine.

By a process of inductive reasoning a rigorous general theory of information systems can be developed in the same way that control theory has developed in the theory of Cybernetics. To be logically consistent, management information systems and construction management information systems must conform to this general theory or develop a fully coherent and explicit alternative definition.

This paper basically proposes that the model (d) of figure 1 be taken as the generic form of an information system. Further a definition of an information system is proposed as follows: (after a suggestion by H. Knoepfel) " An information system is a resource consuming system or device

developed to supply information, of a particular kind or about a particular topic to an intelligent user or "client" system"

3.3.2 CONSEQUENTIAL INSIGHTS

(a) General comments

If I.S.'s are a pervasive element in human life we may perceive:

- That they are (human) artifacts. To be created and destroyed. To be erected by a problem solver in the pursuit of an answer.
- That a number of systems may be functionally equivalent. Thus Mr. Reuter's field reporter plus either his original carrier pigeon, a telegraph set, a portable facsimile transmitter or with a portable radio and satellite link may all be viewed, by the user, as being functionally equivalent information systems.
- That we may view information acquisition as a goal oriented activity involving a set of entities operating processes which consume resources. Hence ideas of cost and cost/benefit can be discussed. The idea of a system as a set of processes enjoins the idea of "search" as a component of an I.S.
- That engineers, or other system designers, will generally be able to synthesise or develop a number of different technological means to achieve the same ends. (c.f. E.V.Krick - "Methods Engineering"), e.g. compaction data on earthworks can be acquired by the degree of bounce of a vibrating roller (Dynapak) or by nuclear densitometer. These means, whilst being functionally equivalent, may differ in cost. Normally, engineering design involves the selection of the least cost alternative. I.S.'s then can be regarded as having a commercial as well as a technical content.
- If a I.S. is an artifact its design will involve the same processes as industrial design generally. c.f. E.V. Krick " An Introduction to Engineering and Engineering Design".
- That given a designer who can develop a I.S. to acquire a nominated piece of information, there is a higher level problem posed by the "client" of such a system designer. i.e. What information do I need? Is it cost effective to acquire it? At the "client-level" trade-offs are necessary to determine the benefit of better information versus the cost of better information etc. From a client point of view, it is noted that the utilisation/utility of a information system will tend to be in accordance with its cost of operation. Thus a low-cost search of a data base will be often executed by a client whilst its high cost manual equivalent may not be. The question of the cost-effectiveness of information acquisition is discussed from an economists and marketeers point of view in Galatin & Leiter (1981). The interactiveness of cost of search and the value of information required are basic problems in the mining and R & D Industries.

(b) Information Systems and Degrees of Intelligence

Information systems can be designed to have various amounts of intelligence. Thus one can design I.S.'s to act in the following modes:

- Monitoring and reporting systems. e.g. basic facts only.
- Alerting systems e.g. exception reporting, deviance reporting.
- Situation or Pattern Detecting Systems. e.g. machine condition, stock exchange opportunities, mining anomalies.
- Analytic, interpretive. e.g. What does it mean? - e.g. military intelligence.
- Forecastive: e.g. weather bureau, cost to complete.
- Diagnostic - e.g. What is the cause? (c.f. expert system).
- Action suggestive - e.g. action suggestive (c.f. U.S. SABRE system).
- Action choosing and advising e.g. Abort systems in space flight; expert systems e.g. concrete repair.

(c) Chained, Nested and Interconnected I.S.'s"

Using the above as examples it is clear that the higher order I.S.'s may contain low order I.S.'s as subsystems. Thus one can have chains of I.S.'s, with the output of one feeding the input of another or else that may be interconnected as hierarchies, in parallel or in various circuits. Their outputs



may be compared using logical operations such as and/or gates to further complicate matters.

(d) Information Systems With Memory

Information systems can be developed that will have memory or information capabilities. Historical data can be recalled and compared with present results. Time series-data can be acquired, analysed and trends or forecasts made.

(e) Information Systems Incorporating Prediction Models

Information systems can be developed that incorporate prediction models.

(f) Information Systems Taxonomy

A variety of categories of I.S. can be identified e.g.

- Repetitive or on-going versus one-off.
- Single purpose versus multipurpose.
- Programmable versus fixed.
- User interactive.
- Cyclic or batch versus continuous in operation.
- For novel situations versus programmed situation.

(f) Usage of Information Systems

Information systems may be invoked by people under various circumstances. Thus one might utilise I.S.'s in various contexts e.g.

- The various phases of a project - Investigation; feasibility; conceptual design, detail design; tendering, contract letting, preconstruction planning, construction.
- In analysis versus synthesis.
- In planning, coordinating, organising, monitoring, staffing etc.
- In strategic planning, tactical planning, operations planning etc.

Clearly though, information search, acquisition gathering and processing are all pervading activities hence information systems as are defined here are equally all pervasive.

3.3.3 ALLIED CONCEPTS AND ALTERNATIVE VIEWS

So far in this paper discussion has focused on the concept of Information Systems but not on the utility of the concept. Is it more fruitful to talk of information systems rather than say data or knowledge acquisition systems, instrumentation systems, data processing systems or search systems? Should one focus on the process of say search, data reduction and presentation rather than use the system idea? Each of these viewpoints seems to highlight different facets of the information activity.

3.4 PROBLEM NUMBER 4 -WHAT IS A MANAGEMENT INFORMATION SYSTEM?

Logically, M.I.S.'s should be a subset of I.S.'s as in figure 2.

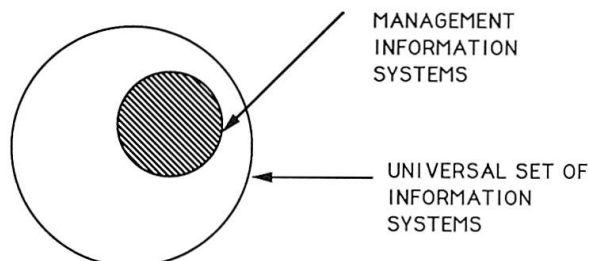

Figure 2. M.I.S. as a subset of I. Systems

Semantically, a M.I.S. is presumed to be a I.S. intended to be used by "management" or alternately an I.S. intended to be used by "managers". The problem arises now as to what the terms "manager" and "management" mean.

3.4.1 WHAT IS MANAGEMENT?

In endeavouring to answer the question of what management is and/or what managers (management does) by reference to the management literature, a major problem related to this field emerges.

There are many different, some non-logical, conceptions of what management is. Hence writers and thinkers on this subject use the same label to describe a variety of things, processes, acts, etc. The result is akin to a Tower of Babel. Further, it appears that many writers are confused even in their own usage. Some major writers in this field also seem to use this term to apply to an aggregate of ideas (c.f. Koontz et al "Management").

There are major philosophical problems in definition of the management concept. For example:-

1. Some writers consider management to be a process undertaken by people called managers (e.g. Singleton W. T. - Managers as System Components p.28 of " Book Management Skills"). Other such as Herbert Simon consider it a process distributed over an organisation. e.g. as in self organising systems. The key question here is management lumped or distributed?
2. Some people use the term management as a collective noun to refer to a class of people such as executives who are distinct from another class of people called labour. In this sense, a M.I.S. is an I.S. designed to be used by this class of person. Contrast this to another usage whose management is considered a particular kind of work. Thus some writers conceive of executives who act as managers only 20% of their time. The logical problem here is - if management is a distinctive style of work it can be done by persons not called managers. Alternately, an individual may pass through a management "zone" momentarily and do a fraction of a management task. If a certain kind of activity called management exists how can one operationally define it? By what test can it be identified?
3. Some major management writers such as Peter Drucker use the term rather elastically but in his book "The Practice of Management", he is specific. "Management" is the name given to a specialised "organ" in an organisation". This is the view originally developed by Fayol. For our purposes here, is an M.I.S. only for the people in this specialised organ?
4. Logical problems arise in the use of the term management because it is used in a technical as well as a people sense. Thus, books are written on the subject of the management of computer memory, the management of the procurement process, the management of fixed assets in a construction company and personnel management. The distinction between the people sense of management (e.g. to be a manager you have to have subordinates) and the thing sense of management is that in one, the manager can be a thing, process or system whilst in the other it is only people.
5. Real versus apparent management. Some people (c.f. Alfred P. Sloan) distinguish "real" management from apparent management. Here an organisation is viewed as a decision making machine. The real management is in the design and establishment of the social machine to do the work. The actual details of the work to be processed is immaterial. The importance here is the mechanism not the work. Thus in a recent study, the U.N.S.W. set up a new mechanism for resource allocation which is invariant over the particular data or financial year.
6. Management viewed as a (staged) process. To some, the word management is used to refer to a sequential process e.g. plan, organise, coordinate, staff, command and execute. If it is not this process it is not management.
7. System and Subsystem. To those in systems engineering "management" may be used as a term to refer to all the activities to be performed in the supra-system. (c.f. C. West Churchman).
8. Management Denied. Another group of thinkers effectively deny the existence of management as a distinctive activity. To them, management is just human problem solving under another name. Simon, and to some extent this author, are of this ilk. In terms of trying to define what an M.I.S. is the difficulties involved are huge. Clearly, if this term means all things to all men, then the term M.I.S. has only meaning under a specific usage of the word management. Unfortunately, most writers take it as obvious that their way of looking at the world is the correct (and only) way and fail to spell out what they mean.
9. The term project management is a common use of the term management. The trouble here is that the term project is multi-level in nature and can be applied to a modest activity such as planting a shrub as well as placing a man on the moon. Since any macro project can be decomposed into micro-projects all behaviour is management.



10. Management theory has traditionally dealt with control as a key activity of management. Unfortunately the study of Cybernetics reveals that the concept of control applies at a micro as well as a macro level. Like information systems control systems are all pervasive. They can be nested, linked, diffused or lumped. They can involve human elements as well as machines. Similarly to the control theory, if management is concerned with the design of action, then here again management may be a macro as well as a micro thing.

3.4.2 CONCLUSIONS

So far as this paper is concerned management theory is currently a morass. It is not possible to define what management is or is not at a rigorous level. Hence the whole question of what a management information system is is an open question. An operational definition, such as is used in the physical sciences is desperately required. (Ref. Percy Bridgeman "the Logic of Modern Physics").

4. DEFINING MANAGEMENT INFORMATION SYSTEMS

4.1 A MYRIAD OF SYSTEMS

To date, we have been concerned in this paper with ideas of system, management and information. If we couple these varying conceptions together, especially the varying conceptions of management to the previous ideas of I.S.'s, we end up with a myriad of things that can be classed as Management Information Systems. Further, if we explore the definition of who might be "a manager", we get hierarchical ideas. Thus, we get I.S.'s destined to be used by a tea lady in the management of her affairs through to M.I.S. destined for use by only the top executive in a international corporation. Further, we can classify M.I.S.'s themselves into types such as formal, informed, automatic, exception based real time, interactive etc. Again, for consistency, if a thing is classed as a M.I.S. for an executive e.g. a M.I.S. for control of cash flow. It should also be allowable on an M.I.S. for a housewife who is on a very tight budget with house repayments.

4.2 A DATA HUB VIEW

In one theory of management, management is the process of allocation of creative resources to ends. This problem is akin to the economist or O.R. practitioners view of things. (c.f. Miller & Starr "Executive Action and Operation Research"). A MIS may be viewed as the totality of data inputs required for investment analysis (c.f. De Neufville & Stafford "Systems Analysis for Engineers and Managers"). (c.f. The variety of data inputs to a process such as the preparation of a new city plan). Thus, the manager of a portfolio of investments will need M.I.S.'s to advise him of the current performance of his investments, i.e. monitoring and performance measuring systems plus I.S.'s advising of all alternative investments and their performances. If all alternatives are changing, it becomes a dynamic processing problem. Clearly a view of MIS's achieved through this data hub view will be at considerable variance to that developed by people who use the "real" versus apparent theory of management. Each though is consistent in its own terms.

4.3 SOME CRITICAL DIVISIONS

Historically, the use of the term, M.I.S. has been restricted to the on-going formal large scale schemes intended to be used for senior management e.g. corporate accounting systems, large computerised cost control systems on major projects and so on. These are generally concerned primarily with commercial problems such as cost and time control. The nub of the question in terms of this paper though is "is this restricted view acceptable or should one extend the definition of M.I.S. to include episodic information needs, the needs of junior and middle management and especially the need for technical information as distinct from commercial and control data.

4.3.1 Technical Non-Technical Boundary

If the technical/non-technical demarkation is eliminated, one gets a veritable flood of technical systems asking to be classed as M.I.S.'s, e.g.

- Foreman delay surveys.
- Stress wave pile driving data systems.
- Non-destructive testing, e.g. gamma radiography of welds.
- Information systems for methods improvement e.g. time lapse.

- Performance information for methods designers e.g. merits of explosive A versus explosive B.
- Estimating data bases.
- Computerised indicative estimating programs c.f. formwork.
- Technical predictor models e.g. cuttability of rock.
- Soil mechanics drilling systems.
- Concrete compression testing system.

The whole problem here is: "Is technological decision making acceptable as management work?" If a mine manager carries out a six week study of the virtue of a proposed new explosive versus his existing one and commissions a university to make a six week long time-lapse movie of the mine, before and after, and to report on the results. (Ref. Chalmers University study -Sweden). Is this management? As a different example, the author conceived of the FIGAS system especially to provide technical data for management? It seems to have achieved industry acceptance as a managerial tool-but is it a M.I.S.? If the management of technical field operations is acceptable, as an M.I.S., then each technical task has a logic and its own data needs. (c.f. Knowledge base concepts in O'Brien J. and Woodhead R. " A structure for Construction Research " Proc. NSF Workshop on Enhancing Construction through State-of-the-Art Research University of Texas at Austin, Texas, 1984.) Thus the manager of a pile driving operation needs M.I.S.'s to control stresses in the pile, to monitor progress to control noise levels etc. Tunnelling managers need information on ground conditions, level of poison gas etc.

4.3.2 Project Boundary Restrictions

Traditionally, it has been long accepted that the term Project Management is a genuine management activity if applied to major construction project or to things like NASA. The word "project" however, can have micro as well as macro application. Thus at U.N.S.W. one of our student teaching exercise involves a one week field operation in the centre of Australia. It is a special exercise attempting to teach remote area project management. Is this project management? On a lesser scale yet, in the author's laboratory, we have a standard construction project to erect a steel falsework tower that takes one man less than ten minutes to complete. Is this a project? Some authors extend " project" to include all technical field operations not just building and construction but to installation of computers, and to the testing of H-bombs. The implications of this usage is that if project management is acceptable as management, then a macro project can be broken down into a set of micro-projects each with possibly its own project manager. Thus the activity "install well points" or "connect and test grout lines for foundation grouting" could be considered a distinctive project for a gang or sub-contractor. Each activity would have some manager. (either individual or group). In the limit, a single tradesman hanging a door may consider it a project and himself its manager. The implications of this view for M.I.S.'s is that everyone on a site may be considered a project manager in one form or the other and hence in need of a M.I.S. appropriate to his task. The only real difference is in the complexity or scale of the "project" to be managed.

4.3.3 Regulation/Control/Coordination/Scheduling Boundary

Traditionally, most of the discussion on management (in construction at least) appears to focus on the role of a manager or regulating, controlling or merely coordinating the work of subsystems. Little discussion seems to occur on the role of the manager, especially lower order managers, in planning the content of the work, determining the methods and equipment to be used in quality assurance, in diagnosis of situations and determining remedial action (ref Kepner Tregoe "The Rational Manager). The implications for M.I.S.'s is important for if one accepts that problem identification, diagnosis, planning, design etc. are part of management, then all the data inputs that are required for decision making are potentially supplyable from a M.I.S. In the terms of H. A. Simon, in his book Administrative Behaviour, the proper unit of analysis in decision making is the decision premise. A M.I.S. can be coupled to each decision premise. In O'Brien's analysis (Texas NSF op cit), the concept of knowledge bases and predictor models is important. These are the historically based decision inputs as distinct from the current situational variables.

4.3.4 The Up-Down Boundary

Traditionally, M.I.S.'s have been viewed as operating from the bottom up i.e. information from sub-ordinate system to superior system. If one takes the view though that the superior system may be considered the environment for an autonomous lower system then one of the information



systems required by the subordinate system for its planning and design is one aimed at gathering the performance expectations, policy constraints, etc. of the supra-system. Since these data are essential to the management of the sub-ordinate system then it must be an M.I.S. Of special note is that all project documentation e.g. plans, specification, contracts, instruction, corporate policies, laws, bye-laws etc. become forms of M.I.S.

4.3.5 Conclusions

If all the above are candidates for M.I.S.'s then virtually, all information flows on a construction site can be considered a M.I.S. in some form. Perhaps rather than asking what is an M.I.S. we should ask is there anything that isn't?

4.5 OPERATIONALLY DEFINED M.I.S.'S

As an alternate approach to defining an M.I.S., it is possible to take an operational approach (c.f. Bridgeman op cit). In this approach, we take a variety of candidate systems, present them to a person or group and ask them to categorise them as M.I.S. or not-M.I.S. Thus for example:-

- * Is probe drilling in tunnelling a MIS?
 - * Are grout flowability test processes MIS's ?
 - * Are corporate policy statements MIS's for the workers?
 - * Is Woodhead's Cyclone/Time Lapse System an M.I.S.?
 - * Is O'Brien's Figas System (1984) a M.I.S.?
 - * Is a concrete slump test a MIS?
 - * Is Fukushima (1984)'s NATM tunnelling system an M.I.S.?
- etc.

By this process an agreed and explicit definition of what an MIS is can be arrived at. Because the selection criteria are explicit, even if different authors choose to use the term in different senses at least it will be clear as to how the term is being used.

SECTION B - A REVIEW OF M.I.S.'S IN THE GENERAL MANAGEMENT LITERATURE

1. METHODOLOGY

Having developed a set of analytic tools and concepts for discussion of M.I.S.'s, a survey was made of the *general* management literature to establish the published state-of-the art. A wealth of information was found on this topic indicating that many writers had specifically targeted this area for their work. Given the restricted time available for this survey only papers or books with the specific words M.I.S., Management Information Systems or Information Systems for Managers were surveyed.

2. RESULTS

Some scores of books and hundreds of articles on this subject were discovered. Much of the work though was of poor to very poor quality. A listing of some of the better writings on this subject is given at the end of this paper.

2.1 FRAMES OF REFERENCE

When discussing M.I.S.'s, writers consciously or unconsciously adopt a frame of reference to the topic. In the literature a number of basic ways of looking at M.I.S. were discovered. Very roughly they fall under the following groups. Each point of view gives its own particular insights and constructs. All may fruitfully be employed to comprehend M.I.S.'s.

2.2.1 Individual Manager Focus

In this view, an individual manager is the centre of attention. All processes used by a manager to keep himself informed or to gain information, whether formal or informal, corporately provided or ad-hoc, ephemeral or systematised, according to this view can be described as M.I.S.'s.

2.2.2 Decision focus

A number of writers have adopted the idea of decision support systems as the key concept in discussion of M.I.S. Here the emphasis is on a specific decision or kind of decision to be made or on a specific decision process irrespective of which person or group is going to make the decision.

2.2.3 Pooled data bases

Where one has a number of individuals who need the same basic information for their technological activities it is possible to consider them as a group and to design a group system. Thus by pooling their needs and cooperating, it is possible to develop a common denominator system.

2.2.4 The Organisational Process Orientation

If organisation or individuals can be considered to be engaged on various processes, then information systems can be coupled to their processes as feeder systems.

2.2.5 Task Focus

If one adopts a task focus or technological point of view, one can perceive that each and every job of work has its own particular or peculiar (set of) information or data needs. Thus a production manager will perforce need data on stock levels and materials availability, a quality control manager will need test results, an hotel manager will need information about bed availability etc. Given this need, there will be a demand to erect information systems that yield answers to the specific questions that pertain to the task. To achieve this end, individuals and groups erect specific systems/machinery/mechanisms to generate the data required. As the information is specific to the task and the problem solver is placed in a specific environment with respect to costs, time, data utility etc., the result will be the development of a custom tailored, purpose made "machine" peculiar to this problem solver and his needs.

(a) Rationalised and integrated task based I.S's

If an organisation is viewed as a work system, it will develop a host of (M)I.S's appropriate to that work. Given these M.I.S's, it may be possible if there are some common denominators between systems that rationalisation and integration may be possible.

(i) Use of the word MIS

From this discussion, it can be seen that the term M.I.S. can be used for a local stand-alone system, or an integrated system. Industry usage tends to call the same thing an I.S. if it's small or an M.I.S. if it's large.

(ii) The holy grail idea

Some writers go even further and imagine the concept of a single M.I.S. for a whole corporation and they view this as some sort of holy grail. To what extent this is possible or desirable is debatable.

2.2.6 Reporting and intelligence Systems Focus { One way data flows}

Another way to look at M.I.S. is via the concept of a reporting system or an intelligence gathering system. This may be considered as the "front-end" to an analysis and/or decision making system. Three types of reporting systems were identified.

2.2.7 Data and Information Gathering Systems

This frame of reference for looking at M.I.S's may be considered essentially similar to that of reporting and intelligence systems but still more directed in its activities.

2.2.8 The Corporate Services View

One frame of reference that is often adopted in discussions of M.I.S's is the corporate services point of view. Here M.I.S's are the facilities "laid-on" by the firm for the benefit of its members.

2.2.9 The Infrastructure focus

In this view, organisations set up mainstream data gathering and processing systems which the organisation maintains to keep itself informed as to internal and external processes. Ein-Dor for example likens M.I.S. to the central nervous system of a human being.



2.2.10 *The Organisational Anatomy Point of View*

A number of writers, perhaps the bulk of writers, view the question of M.I.S. to largely relate to the formal large scale structures/machines/systems organisations set up to support the day to day activities of organisations. i.e. routinised activity.

2.2.11 *The E.D.P Point of View*

Many writers restrict their definitions of M.I.S. to the operations of the E.D.P. department of (large) corporations. They generally view M.I.S. as a large on-going efforts in organisations whose effect is to produce management reports.

2.2.12 *The disciplinistic Orientation*

Various practitioners and writers write of M.I.S.'s from a discipline point of view. Thus accountants will see M.I.S.'s from the orthodoxy and historic tradition of their profession.

2.2.13 *The Parameter Instrumentalist Focus*

In this view, a M.I.S. may be a stand-alone system designed to yield a specific parameter or parameter value. This parameter may or may not be useful to any particular user but is designed for generic use. In Brookes's version, M.I.S.'s are the specific instruments whereby management discovers or is advised of the status of those variables which represent the state of the organisation. e.g. stock levels, costs at bank, debtors/creditors etc.

2.2.14 *Activity Focus*

If one conceptualises information as relating to search systems, then one gets a different view of M.I.S.'s, their use and boundaries.

2.2 SUMMARY OF THE GENERAL M.I.S. LITERATURE

In reviewing the general management literature, it would be fair to say that it is to a very large degree confused. Various writers adopt different frames of reference with respect to M.I.S. *without* defining their terms. Worse, many writers mix their conceptions of M.I.S. and switch from usage to usage in different contexts. As a result, the quality of writings in this field seems to be poor and lacking in intellectual rigor. Further, there seems a total preoccupation with computers and E.D.P. systems. Macro systems seem largely to be discussed. Within the literature, the word M.I.S. tends to be used most commonly in three major senses.

- Any large scale formal on-going task based corporate system.
- A single integrated corporate wide system (The holy grail concept defined earlier).
- The E.D.P. sense.

All of these usages are common in the literature. Concept number 2 and 3 are probably more prevalent than number 1. Writers in category two are often messianic in their advocacy. Most case studies and sample systems operating in corporation are examples of sense number 1. The term MIS when used as initials tends to refer to the holy grail idea.

SECTION C - MANAGEMENT INFORMATION SYSTEMS IN CONSTRUCTION - A LITERATURE REVIEW

1. CATEGORISED FINDINGS

An exhaustive survey of the construction literature was undertaken to discover writings relating to the topic of Management Information Systems. After reviewing the articles uncovered, the following primary orientations relative to M.I.S. can be identified:-

1.1 The Project Cost and Schedule Control Systems Orientation

To many writers, the term M.I.S. in construction principally, relates to the large scale formal project management and control systems set up by contractors to enable senior managers to control projects. Figure 1, taken from Nelson (1976) exemplifies this point of view.

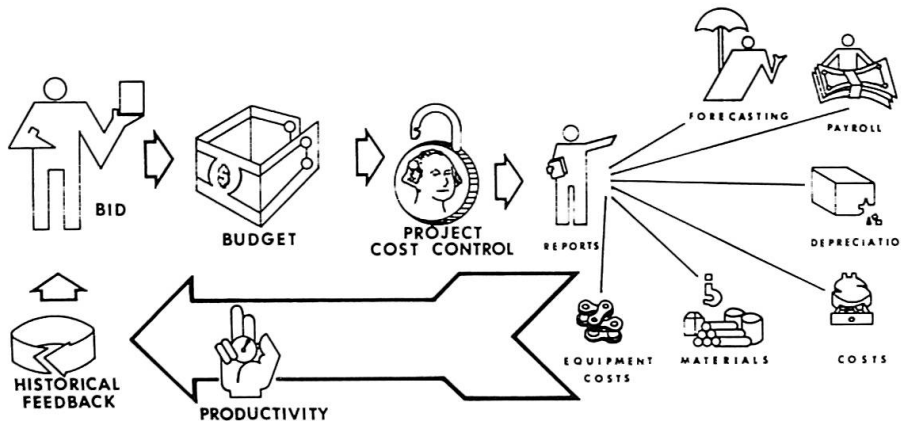

Figure 1. Typical large scale cost-analysis cost-control system

Cost control systems such as these are in common use in project management throughout the world. Typically, nowadays, they are computerised and are highly formalised in terms of cost codes, reporting methodologies etc. Variance from expected performance is a key output. Computerisation though is not necessary. Adrian (1978) discuss a manual system of this kind for small contractors. Gunning (1984) gives a general view of this control process in construction (fig 2).

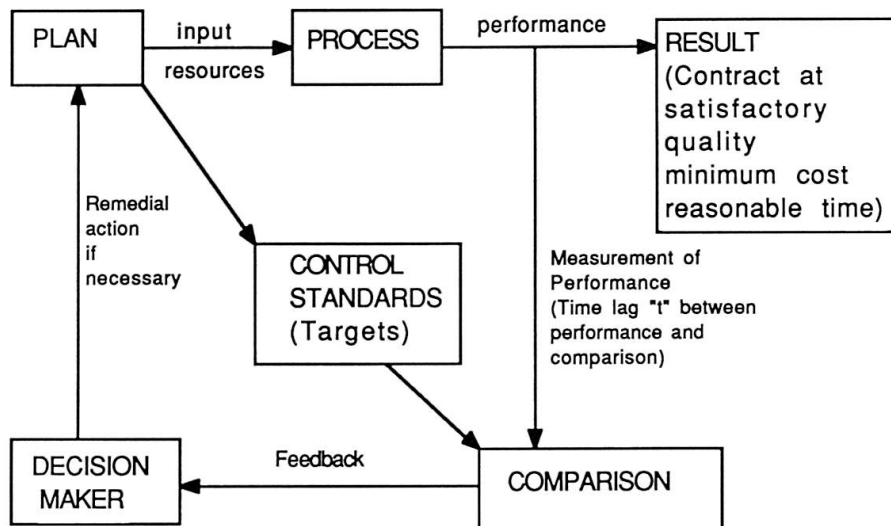

Figure 2. The control cycle (per Gunning)

The essential feature in most cost control systems is the use of a plan/estimate/budget as the reference source. i.e. the programme is optimised to the budget not to the best possible technical activity. Status reports etc may be considered as part of the control systems view. Papers in this general cost/schedule control category include Burger & Halpin (1976). In this sections usage of the word M.I.S., the term principally relates to a kind of system set up to supply the information needs of top management.

1.2 The Information Pipeline - Bundled Information System Orientation

In this approach, an M.I.S. is conceptualised as a centralised information handling system for large projects (fig. 3) Here the project management functions are conceived of as processes on data flows. This view is taken from D. H. Curling (1976).

1.3 Client Level -Resource Allocation/Budgetary Orientation

A number of writers have reported on systems developed by client systems to plan and allocate resources. Blum (1975) for example discusses a system called MISTER (Management Information Systems for Time Expenses and Resources) for the Los Angeles Flood Control System. In connection with resource allocation, it is interesting to note that whilst there are scores of papers on

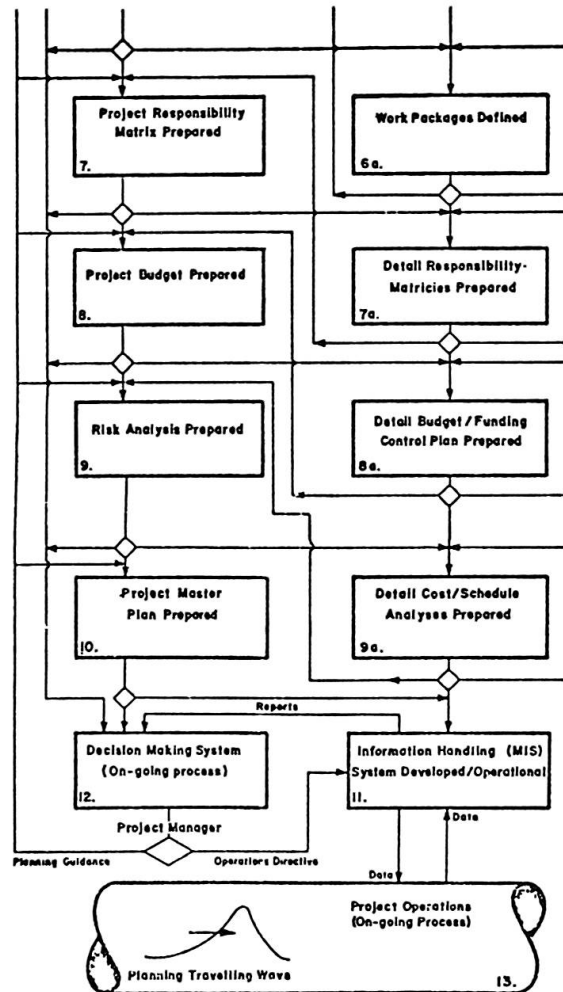

Figure 3. Curling's Model

C.P.M. and Resource Allocation in the construction literature very few writers discuss the information needs of the process. Papers in this category include:- Shaw V. A. (1976)

1.4 The Japanese View

Japanese writers on M.I.S. seem to utilise a completely different conception of the topic than Western writers. It is distinctively more oriented to technological problem solving than the commercial management by exception systems of the West. Further, in principle, the Japanese seem to be aiming for a more integrated system than people in the West. On reading the Japanese Papers though, the author is rather unclear as to exactly what the Japanese conception is and as to whether it is a single conception or a group conception. Kitazumi (1984) depicts the Japanese view in figure 4.

1.5 The Fact Gathering Systems sense

A number of writers use the idea of M.I.S. in connection with field data gathering systems. O'Brien (1984), Paulson (1984) and the Japanese C.I.S. Committee (Kawasaki 1984) follow this sense. Earlier writers on time lapse camera work, activity sampling, foreman delay surveys, clearly had this in mind but did not make it explicit.

Figure 5 is given as illustrative of this conception of a M.I.S. The objective of these M.I.S.'s is generally to feed into methods improvement systems, for historical estimating, for technical planning etc. Papers in this Category include:- Kroll (1976); Adrian (1976); Woodhead (1976).

1.6 The Administrative Systems View

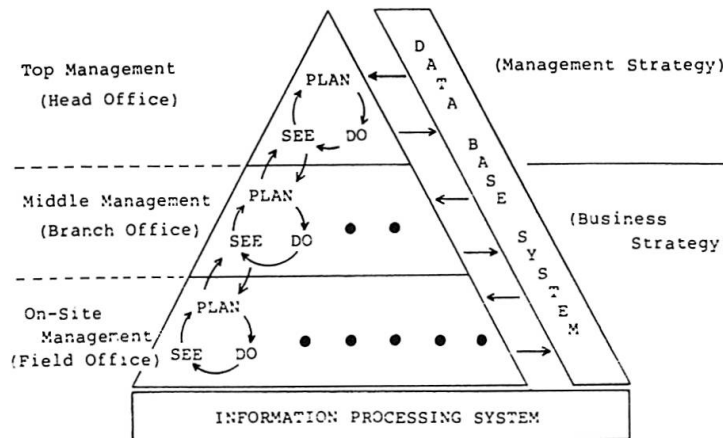

Figure 4. The Japanese CIS view

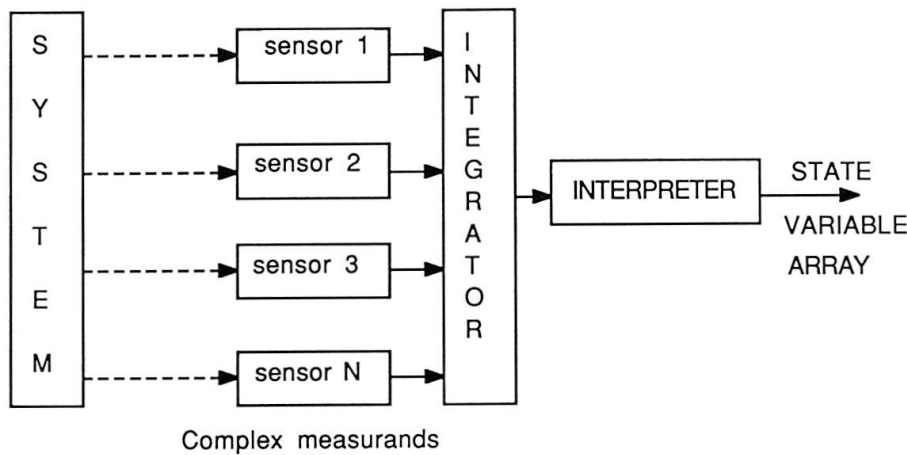

Figure 5. Schematic of FIGAS system (O'Brien 1984)

In this view, M.I.S. are administrative systems e.g. accounting, invoicing, status reporting etc.

1.7 The Design of Construction Operation Sense

Fukushima (1984) conceives of a M.I.S. as being a front-end data acquisition system for a real-time design operation. In this case for tunnel supports in tunnelling by the New Austrian Tunnelling Method.

1.8 The Eastern-Block Orientation

1.8.1 A M.I.S. as a centralised coordination device

In this view expressed by Bratkovic (1976), a M.I.S. is an centralised data pool that can be used by all parties to the building process, especially subcontractors, for coordination of their activities.

1.8.2 Total industry view

Halpin and Tutos (1986) have reviewed the Romanian Construction Ministries system for integrated management of the whole construction effort in that country. A scheme called PLU developed for the scheduling, start-up and control of projects is discussed.

1.9 The War Room Sense

In this conception of an M.I.S. all necessary data for managerial action is fed to a decision maker in the same way information is fed into the war-rooms of generals during battle. Halcomb (1976) discusses such a facility in conjunction with the overall management of the Alaska pipeline. Paulson as quoted in Lichtenberg (1976) may have had this view in mind when he generated figure

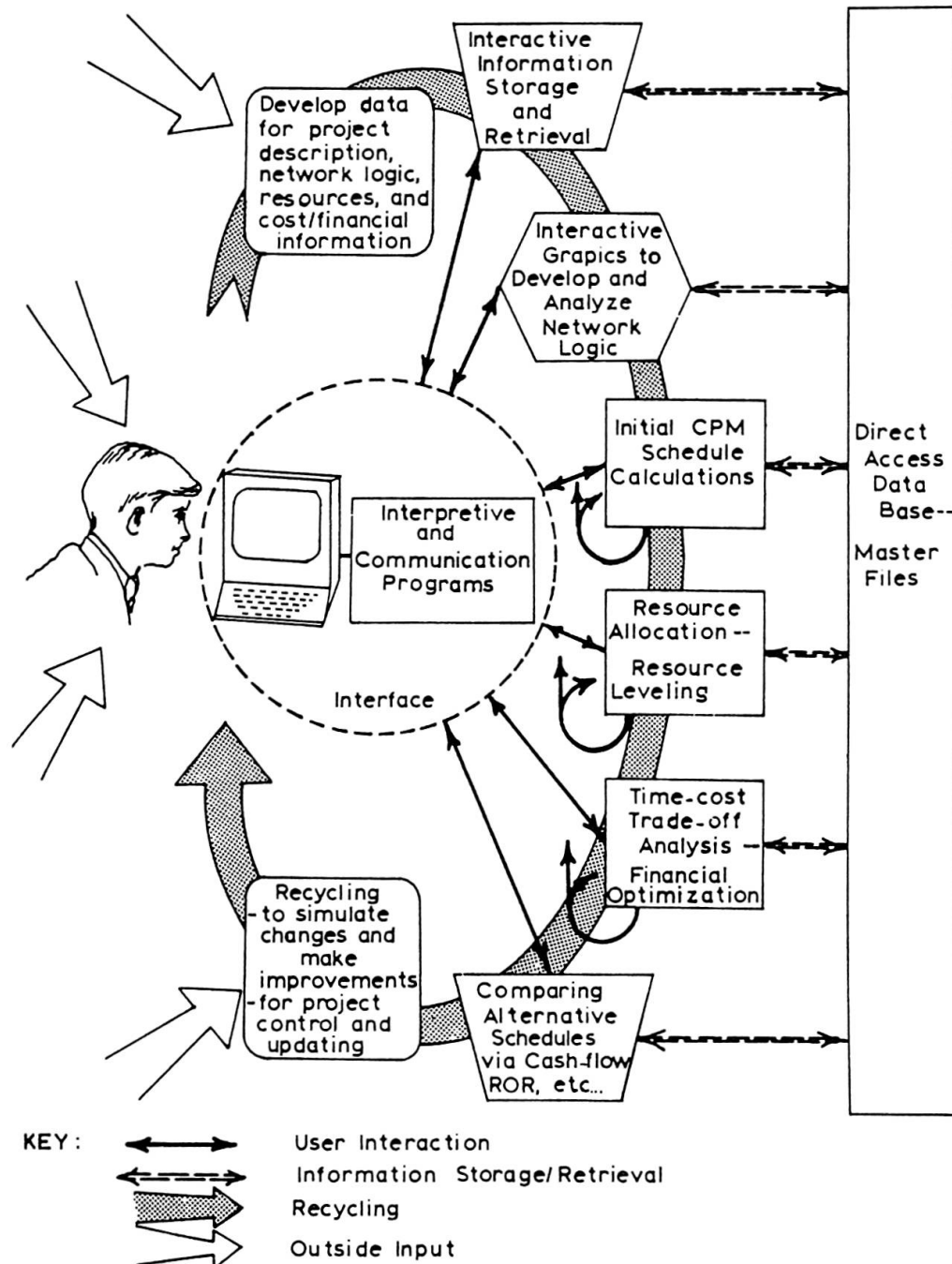

Figure 6. Paulson's man-machine system for project management

1.10 Gunning's View

Gunning's (1984) view of MIS is that of a quality control specialist who looks at the technological process of quality control whenever it occurs and looks to the technical process needs. His ideas are summarised in figure 7. Essentially, it is a process over situation view.

1.11 The Contractor Functional Systems Sense

Only one writer was discovered who used the actual term management information system in relation to specific non-control, areas of construction management. This was Kawal (1976) who discussed an I.S. relating to corporate decision making regarding equipment selection and management. This sole writing is no doubt not exceptional except that the writer had an explicit notion of a MIS. Most writers leave the I.S. idea implicit in their overall concept of management.

RESOURCES	STANDARDS
LABOUR	Labour schedules, Productivity data, Training programmes, Conditions of employment, Disciplinary procedures, TU agreements etc.
MATERIALS (see also QUALITY below)	Materials schedules, Stock-holding levels, Wastage allowances, Storage requirements, Inspection procedures, Delivery programme etc.
PLANT AND EQUIPMENT	Plant schedules, Productivity data, Site layout plan, Maintenance programmes, Company policy, Local requirements (noise, nuisance, working hours etc.)
SUB-CONTRACTORS	Programme, Sub-contract conditions; Contract attendance requirements, Agreed payment procedures etc.
MONEY (COSTS)	Bill rates, Unit cost estimates, Turnover budget, Cash flow forecast, Financial ratios.
TIME (PROGRESS)	Programme and productivity data, contract variations and agreements, Client requirements.
QUALITY	Specifications, Drawings, British Standards, Samples, Manufacturers' data, Building regulations, Expectations of supervisors regarding workmanship etc.
SAFETY AND SECURITY	Legislation on safety, Health and welfare, Local authority requirements, Trade union agreements. Company policy, Established good practice.
INFORMATION	Information schedules, Programme, Contract and Sub-contract requirements, Company policy on record keeping.
METHODS	Methods statement, Productivity data, Work study information, Previous experience.
MANAGEMENT	Contract requirements, Job descriptions, Management development programme.

Figure 7. Concepts of quality control I.S.



2. RATIONALISATION OF VIEWS ON C.M.I.S.

The viewpoints and topics of interest of the C.M.I.S. writers discussed in the last section are totally diverse. They seem to be discussing totally different "animals" or "worlds". Is there any way to reconcile these various views? If we look at the C.M.I.S. writings using the ideas of Section A, it is suggested that one can perceive some method in the madness.

2.1 The Project Management Systems Camp

The Project management systems (PMS) camp is fairly easily dealt with. Traditionally, the construction industry has been faced with a problem of control of large number of activities. It has developed a special methodology to cope with this involving bundled control systems and variance reporting. As projects get more complex, the problems of coordination and control get worse. Consequently, most of U.S. writings on M.I.S. uncovered in the construction management literature can be seen to relate to this particular technical problem. Further, almost all writings found relate to large scale projects such as power plants, nuclear reactor etc. Adrian's work on small scale project management systems is an exception. Generally, papers discussing M.I.S. re P.M.S. will either report on a method used on a project or will suggest or advocate a particular methodology to be employed e.g. Burger & Halpin. Overall in the construction literature 90% of the articles involving the use of the word M.I.S. will relate to this single technical problem. It is interesting to note that no concept of optimality has yet developed in this field with authors advocating various schemes and analysing the cost/benefits of each. The problem is still being discussed at the level of how to get any solution. Basic coping seems to be the current problem.

2.2 The Eastern Block Countries View

Since the Eastern block countries operate in planned economies, the necessity to develop project based control and coordination schemes loom less large. To them industry based coordination is probably the matter of issue. The 2 papers with an eastern block flavour uncovered in this literature search (Bratkovic and Jug and Halpin and Tutos(1986) reflect this industry focus.

2.3 Gunning's view

Gunning's view is interesting since it departs radically from the whole-project management level problem and talks of control as and when it occurs. In this it cuts across many technologies and disciplines. In essence it is the view of general control theory. That is it is the use of a managerial operator to control an operand.

2.4 The Contractor Functional Systems View

Kawal's article really is the tip of an iceberg. It is well known that contractors maintain large data collection and analysis systems associated with:- Fixed asset management; Personnel systems; Future work forecasting; Contract management; Progress payments; Work variations; Extension of time claims; Productivity reports; etc. The implications of only one paper being found in the literature referring to these as Management Information Systems implies either:-

- that they are not conceptualised as such by the industry or that their information dependent nature has not been noted.
- they are deemed essentially simple activities not worth studying.
- practitioners are too busy getting on with the job to bother reporting on their methods.
- there is insufficient academic work in the industry to adequately capture practice.

Whatever the reason, there is a dearth of articles on this topic.

2.5 The Instrumentalists View

This group of writers have largely focused on technological M.I.S.'s associated with specific problems/tasks that are more associated with technological decision making rather than the task of control.

2.6 The Japanese View

This seems to be rather confused amalgam of the:- project management system viewpoint; corporate wide M.I.S. data base concept and the instrumentalist view. Clearly, their work on tunnel monitoring and real time decision making is a task based bred M.I.S. view. This is clearly associated with technical process management as distinct from corporate management. On the other hand, their triangle diagram, previously given, seems to clearly indicate the concept of a corporate wide data base.

2.7 The Client Level View

Here is a specific example of task based systems. Because they are clearly at the senior management strategic planning level, there is no reluctance to call them M.I.S.'s. Generally, however, they relate to the traditional management problem of resource allocation, scheduling and budgeting.

3. COMMENTARY AND OBSERVATIONS ON C.M.I.S.

The following comments are proffered as the result of this review of C.M.I.S.

3.1 Narrow view of management

In the Western literature, management seems to be a term largely intended for senior project managers etc. Foremen and supervisors don't need M.I.S.'s. There is a senior management bias in the literature.

3.2 Large project bias

Most of the western writings on M.I.S. have a large project bias.

3.3 Problem detection bias

Most of M.I.S.'s discussed in the western literature with regard to project management systems relate to the detection of problems. There is little discussion of what happens after the manager detects the problem.

3.4 Control and coordination task bias

Almost all work in C.M.I.S. in the West seems to relate to only one problem - that of the post methods design, whole project control and coordination. Other tasks such as construction methods design, estimating, training etc. are barely mentioned.

3.5 Macro-control-task bias

Whole project control and coordination seems to be greatly discussed whilst control at a physical task or local level seems to be largely ignored.

3.6 The Japanese view versus the West

The Japanese perception of M.I.S. differs significantly from that of the West. The former seem to address the problem from a much more field engineering/technological point of view rather than the money/legal commercial view prevailing in the West.

3.7 Real time process control

In Japan, we seem to be seeing the beginnings of M.I.S. as a practical component of real time process control.



3.8 Limited conceptions of M.I.S. as functional systems

It is clear that the idea of an M.I.S. as a functional element of management action in the construction industry is still only dimly understood. There is little conception of many designs of M.I.S. being functionally equivalent nor that the type of M.I.S. appropriate to the job will be a function of the economics of the situation. There is little insight that management will need to install hosts of M.I.S.'s for its work. The whole idea of an M.I.S. is probably not perceived at all by many in the industry despite their own everyday use of them.

3.9 Programmed Decision making

Current conceptions of M.I.S. seem to be restricted primarily to programmed decision making ideas with little thought of novel problems or task force concepts.

3.10 Optimisation versus working to an estimate

An insight that is offered from this study of M.I.S. is that construction managers seem to be totally preoccupied with the development of control systems and management by exception rather than adopting a system optimisation approach. Conformance to the estimate is an extremely limited view of management responsibilities. Perhaps the functional form of thinking implicit in the M.I.S. point of view will help to sort the wood from the trees and open the way to a new generation of management methods.

SECTION D - OVERALL CONCLUSIONS

This review started with a question as to the extent to which construction practitioners had applied the concepts of management, information and systems to their craft. After this review it is suggested that the answer is - not a lot!

Generally it is suggested that fundamental unawareness of this mode of thinking is common. Secondly, where people have adopted this view conceptual confusion reigns.

It is believed this can be ascribed in part to:

- Confusion about the meaning of the word "information".
- An almost complete lack of rigor in what purports to be general management theory. This lack of a solid conceptual foundation to the field of management is a major problem for aspiring managers and researchers. As to the primary problem of what is and what is not management, multiple arbitrary usages of the term can in the long run only obscure the issues and delay development of a science of management.
- Multiple parallel usages of the term M.I.S.

As to the specific application of M.I.S. concepts to construction, it would seem that practitioners have found a few fragments of the jigsaw but have yet to fabricate a total picture. Generally, it would seem fair to say that management and management information concepts are only at an embryonic stage in the industry. It would appear that management sophistication in the industry is low. Productivity in the industry seems to be developing more by technological push than by managerial push.

So far, these comments have been largely negative. On the positive side, there would appear to be vast opportunities to improve construction management at all levels in the process. Whilst the concept and particular way of viewing the world that comes with the information system idea may be alien to many and sit uneasily as an organising concept in a complex world, it has the virtue of leading to new insights. The construction industry has traditionally emphasised the doing aspect rather than the thinking aspect of its activities. By focusing on intellectual functions and on information systems, the pervasiveness of these functions is perceived (O'Brien 1988). Perhaps the M.I.S. point of view can lead to a new era of progress in the construction industry since it can lead to a shift of attention to the decision making processes of construction and to ways of improving their productivity and effectiveness. One specially interesting outcome from the M.I.S. view is that

it greatly assists designers of systems to conceptualise the problem plus it assists greatly in the development of machines and tools for this function/duty. (c.f. O'Brien 1984). Apart from this, though perhaps the greatest virtue of a review such as this into M.I.S. is that it points to appalling lacks in the theory of management as it applies to construction. If the management function can be more clearly defined, even as to establishing who is a manager, the search for productivity in the construction industry may be greatly enhanced.

As to the future, it is thought that the M.I.S. view coupled with insights into the new technological possibilities of robotics and real time data acquisition and analysis tools could lead to major productivity improvement opportunity areas being identified. With this perception comes some comprehension of the massive changes that could happen to the construction industry in the decades ahead.

REFERENCES ON M.I.S. IN THE GENERAL MANAGEMENT LITERATURE

- Ackoff R.L. & Sasieni M.W. "Fundamentals of Operations Research" J. Wiley 1968.
- [1] Bertrand J.W.M. & Wortmer J., "Production, Control and Information Systems for Component Manufacturing Shops" Elsevier.
 - [2] Brookes C.H.P., Grouse P.J., Jeffery D.R., Lawrence M.J., "Information Systems Design" Prentice Hall Australia 1982.
 - [3] Chacko G. K. "Management Information Systems" P.B.I. New York 1979.
 - [4] Churchman C.W. "The Systems Approach" Delta 1968.
 - [5] Crowe T. & Avison D.E., "Management Information from Data Bases" MacMillan 1986.
 - [6] Davis G.B. & Olson M.H. "Management Information Systems - Conceptual Foundations, Structure and Development" McGraw Hill 1985.
 - [7] Ein-Dor P. & Seger E., "A Paradigm for Management Information Systems" Praeger 1981.
 - [8] Galatin M. & Lecter R. D. "Economics of Information" Martinus Nijhoff 1981.
 - [9] Galbraith J. "Designing Complex Organisations" Addison Wesley 1973.
 - [10] Keen P.G.W. & Scott-Morton M.S. "Decision Support Systems" Addison-Wesley 1978.
 - [11] Kocher M. "Information for Action" Academic Press 1975.
 - [12] Le Breton P.L., "Administrative Intelligence-Information Systems", Houghton Mifflin 1969.
 - [13] Li D.H. "Design and Management of Information Systems" S.R.A. 1972.
 - [14] Lucas H. C. "The Analysis, Design and Implementation of Information Systems" 1976.
 - [15] Lucas H.J., "Information Systems Concepts for Managers" 2nd ed.
 - [16] Massey L. D. "Management Information Systems" Braintree Mass. Mark Pub. Co. 1969.
 - [17] McCosh A.M., Rahman M. & Earl M.J., "Developing Managerial Information Systems".
 - [18] Murdick R. G., Ross J. E. & Claggett J. R. "Information Systems for Modern Management" Prentice Hall 1971.
 - [19] Simon H.A. "The New Science of Management Decision" 2nd ed. Prentice Hall 1977.
 - [20] Thierauf R.J. "System Analysis and Design of Real Time Management Information Systems" Prentice Hall 1975.
 - [21] Trent R.H. & Wheeler T.L. "Developments in Management Information Systems" Dickenson 1974.
 - [22] Trickner R.I. "Management Information & Control Systems" Wiley-Interscience 1976.



REFERENCES ON CONSTRUCTION MANAGEMENT INFORMATION SYSTEMS IN CONSTRUCTION

Legend

- Costec~O'Hare** Proceedings of a conference on computerised cost estimating and cost and project control in building, heavy and powerplant construction - O'Hare airport, Chicago Illinois. November 11-12 1975 - Engineering News Record.
- CIS** Transactions of the Construction Information System Committee of the Japanese Society of Civil Engineers 1984.
- JASCE** Journal of the Construction Division of the American Society Of Civil Engineers.
- CIB~1976-85** International Council for Building Research and Documentation (CIB) W-65 Committee on Organising and Managing Construction.
 1976 1st Symposium ,Washington D.C. USA. U.S Army
 Construction research laboratory ,Champaign, Illinois.
 1978 2nd Symposium, Haifa, Israel. Technion-Israel Institute of Technology.
 1981 3rd Symposium Dublin Ireland. An Foras Forbatha
 1984 4th Symposium, University of Waterloo, Canada, editor V.K.Handa
- Internet~76** Fifth Internet World Congress "Project Implementation and Management Bridging the Gap".Birmingham U.K September 13-17 1976.

- [1] Adrian J.J. "Manual Project Information System" CIB Haifa 1978 pp II 1-16.
- [2] Baltzan C.E. and Gil A. "Application of an operational management information system on the design and implementation of P.W.D. construction projects" CIB Haifa 1978 pp II 27-36.
- [3] Bhandari "Interaction of information flow with CM systems" JASCE sept 78.
- [4] Bradnam R.H. "Management Information- closing the gap" Internet 76 vol 2 pp 139-148.
- [5] Bratkovic D. Jug A. "Some aspects of the introduction of a project information system in a building firm". Internet 76 Vol 2 pp 24-27.
- [6] Brown R.W. "Management Information from project Data" Internet 76 vol 4 pp 352-359.
- [7] Burger A.M. and Halpin D.W. "Application of data base methods to complex project control" CIB Washington 1976 pp. III 42-59.
- [8] Burger and Halpin "Data base Methods for complex project control" JASCE Sept 1977.
- [9] Cheeseman P.G. "The measurement and analysis of tower crane activity on construction projects with particular reference to time lapse photographic techniques" CIB Haifa 1978. Vol 4 pp 229-245.
- [10] Curling D.H. "The project management System - Some thoughts on planning" Internet 76 Vol 5 pp 23-37.
- [11] Dempsey B. and Woodhead R.W "A work pattern approach to the field management of load haul operations" CIB Haifa 1978 vol 4 pp 69-71.
- [12] Dowdle J.R and Smith J.A. "management information for improved control of budgets, costs, and schedules in capital projects" Costec O'Hare 1975 pp 240-271.
- [13] Durbin P.L. "Cost control - A key to survival" Costec O'Hare 1975 pp 138-152.
- [14] Fueki M., Sasaki A. and Hamasaki K. "Present condition of field measurement of shoring (on personal computer). CIS 1984.
- [15] Fukashima H. and Uematsu T. "Construction control system for the New Austrian Tunnelling Method (NATM) "CIS 1984 pp 49-51.
- [16] Gunning J.G "Site management Information and control systems" CIB Waterloo Vol 1 pp 169-179.
- [17] Halpin D.W. and Tutos N. "Construction Information Systems in Romania" JASCE June 1986.

- [18] Haruna M. "Strategies for development of Management System" CIS 1984 p19-25.
- [19] Haruna M. et al "Planning Systems for large scale earthmoving projects" CIS 1984 pp 35-37.
- [20] Hinaji N. "Activities Report of Research Group on Construction Management System" CIS 1984. pp 5-7
- [21] Hinaji et al "Estimation System in work control System" CIS 1984 pp27-29.
- [22] Hirata Y. "Activities report of Research Group on Management and Control Techniques" CIS 1984. pp 11-15
- [23] Hirata Y. and Ueda N. "The construction Management by office computer" CIS 1984 pp33-35
- [24] Ice J.R. "Field estimating and Cost control" JASCE Sept 1963.
- [25] Jha C.K. "The role of PMIS in the evolving CM Concept" Proc. Project Management Institute Sixth Annual Seminar/Symposium 1974 Washington D.C. Sept. 18-21.
- [26] Kawal D. "Information for effective corporate and project control" Costec O'Hare 1975 pp 216-239.
- [27] Kawal D.E. "Information utilisation in Project Management " JASCE Nov 1971.
- [28] Kawasaki K. et al "Computer-aided Construction Management System for scheduling and Control" CIS 1984 pp31-33
- [29] Kawasaki K and Haruna M. " Research Activities in the Construction Information System Committee of Japan Society Of Civil Engineers " CIS 1984. pp 1-5
- [30] Kitazuma A. "Activities Report of methodological Research Group" CIS 1984. pp15-19
- [31] Kroll M.R. "New applications of time lapse photography to construction management". CIB Washington 1976 pp. IV 149-156.
- [32] Levitt R. "New methods in construction Systems" JASCE Sept 1974.
- [33] Logher R.D and Levitt R.E "Principles for an integrated MIS system for design firms" CIB Haifa 1978 ppIII 225-238.
- [34] McDonough N.H. "Information Systems in the Management of Projects" CIB Dublin 1981 pp A.1.137
- [35] Menon U. "Project management and MIS: An emergent relationship" Internet 76 Vol 4 pp 124.
- [36] Nakagami M. "Study of small business Computer systems for site offices in Hazama-Gumi, Ltd." CIS 1984 pp43-45
- [37] Nelson C. "Heavy construction estimating" Costec O'Hare 1975 pp 82-111.
- [38] Nilson A.L. "Economical systems for computerised management controls" Costec O'Hare 1975 pp 4-24.
- [39] O'Brien J.B., Knott J.L. and Woodhead R.W. " A system for fully automated capture and analysis of field performance data " CIB Waterloo 1984 pp 2.445-454.
- [40] O'Brien J.B., " Intelligence work - A neglected aspect of organisation and management" S.Peer Memorial Publication, Technion, Haifa, Sept 1988.
- [41] O'Brien J.J. "Computerised Management Tools" Costec O'Hare 1975 pp 160-202.
- [42] Ohta J. "Activities report of research group on Cost management System" CIS 1984. pp 9-11
- [43] Ohta J. and Tsujie T. "The study of Computer-aided Information treatment as a Construction Management System" CIS 1984 pp 29-31.
- [44] Ohto M. et al "outline of the management system for the reclamation" CIS 1984 pp37-39
- [45] Paulson B.C. "Hand-Computer Simulation and analysis of construction operations" CIB Dublin 1981 pp A.1.83.
- [46] Paulson B.C. "Exploring the potential for real time management information systems" CIB Waterloo 1984.
- [47] Ragade R.K. and Handa V.K. "Management Information Systems in Construction" CIB washington 1976 pp IV 209-222.
- [48] Rogge D.F. "Foreman delay surveys for construction sites" Dept. Civ. Eng. Uni. Texas Austin Dec 1981.
- [49] Russell A. and Triassi E "General Project Control Practices and MIS" JASCE Sept 1982.



- [50] Russell A.D. "A framework for Analysis of Management Information Systems for Medium-sized Building Contractors" CIB Dublin 1981 pp D.1.24
- [51] Sasaki M. "Activities report of Research Group on Construction Control System" CIS 1984. pp 7-9
- [52] Schlick H. "Project Integrated Management System (PRIM) " JASCE June 1981.
- [53] Schlick H. "Project Integrated Management System -PRIM" CIB Dublin 1981 pp A.1.69.
- [54] Sewera P. "A general logic design and essential modules of a practically applied management information system for the project management" Internet 76 vol 5 pp57-64
- [55] Shaw V.A. "A management information system for the control of capital works in the public sector" CIB Washington 1976 pp. II 233-246
- [56] Shimizu K. "Fundamental concept of work system in construction Industry" CIS pp 25-27.
- [57] Swedish Council for Building Research "The information Concept in Building" CIB report Publication 65, Stockholm Sweden 1982 pp 1-193.
- [58] Takada T. Development of scheduling and controlling System of placing Concrete for Concrete dams" CIS 1984 pp 41-43.
- [59] Tanaka Y. "Management system for the deep mixing method engineering work" CIS 1984 pp 39-41
- [60] Teicholz P "Cost Systems: Problems (and some Solutions)" Costec O'Hare pp153- 159.
- [61] Tucker R. & Rogge "Implementation of Foreman delay surveys" JASCE Dec 1982.
- [62] Umezono T et al " Overseas Work Management System" CIS 1984 pp 45-47.
- [63] Walker D.H.T "Use of word processing on the Collins Place Project" CIB Dublin pp A.1.28
- [64] Woodhead W.D. "Measurement of productivity in the Australian Housebuilding Industry" CIB 1976 Washington pp IV 236-255.