

Vehicle properties for bridge loading studies

Autor(en): **Mulcahy, N.L. / Pulmano, Victor A. / Traill-Nash, Rupert Whitfield**

Objekttyp: **Article**

Zeitschrift: **IABSE proceedings = Mémoires AIPC = IVBH Abhandlungen**

Band (Jahr): **7 (1983)**

Heft P-65: **Vehicle properties for bridge loading studies**

PDF erstellt am: **22.07.2024**

Persistenter Link: <https://doi.org/10.5169/seals-37500>

Nutzungsbedingungen

Die ETH-Bibliothek ist Anbieterin der digitalisierten Zeitschriften. Sie besitzt keine Urheberrechte an den Inhalten der Zeitschriften. Die Rechte liegen in der Regel bei den Herausgebern.

Die auf der Plattform e-periodica veröffentlichten Dokumente stehen für nicht-kommerzielle Zwecke in Lehre und Forschung sowie für die private Nutzung frei zur Verfügung. Einzelne Dateien oder Ausdrucke aus diesem Angebot können zusammen mit diesen Nutzungsbedingungen und den korrekten Herkunftsbezeichnungen weitergegeben werden.

Das Veröffentlichen von Bildern in Print- und Online-Publikationen ist nur mit vorheriger Genehmigung der Rechteinhaber erlaubt. Die systematische Speicherung von Teilen des elektronischen Angebots auf anderen Servern bedarf ebenfalls des schriftlichen Einverständnisses der Rechteinhaber.

Haftungsausschluss

Alle Angaben erfolgen ohne Gewähr für Vollständigkeit oder Richtigkeit. Es wird keine Haftung übernommen für Schäden durch die Verwendung von Informationen aus diesem Online-Angebot oder durch das Fehlen von Informationen. Dies gilt auch für Inhalte Dritter, die über dieses Angebot zugänglich sind.

Vehicle Properties for Bridge Loading Studies

Propriétés de véhicules pour des études de charges d'un pont

Fahrzeugeigenschaften für Brückenbelastungsstudien

N. L. MULCAHY

Structural Engineer
Bull Ferranti and Collier
Sydney, Australia

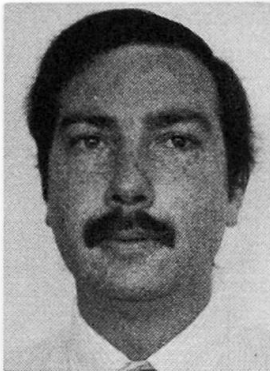

N. L. Mulcahy received the degrees of B.E. (Honours Class I) in 1976 and Ph.D. in 1982 from the University of New South Wales. Since 1979 he has designed a variety of domestic, commercial, industrial and bridge structures.

V. A. PULMANO

Associate Professor
University of New South Wales
Kensington, N.S.W., Australia



Victor A. Pulmano holds degrees of B.S.C.E. (University of the Philippines, 1960), and Ph.D. (Northwestern University, U.S.A., 1964). His research interest includes the applications of the finite element methods in structural analysis and mechanics.

R. W. TRAILL-NASH

Associate Professor
University of New South Wales
Kensington, N.S.W., Australia

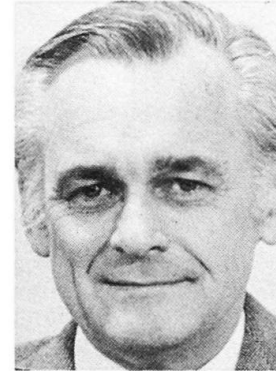

Rupert Whitfield Traill-Nash obtained his B.E. at the University of Western Australia in 1945, and his Ph.D. at the University of Bristol, England in 1949. He was a Principal Research Officer in the Aeronautical Research Lab., Dep. of Defence, prior to joining the Univ. of N. S. W.

SUMMARY

Static and dynamic tests were conducted to measure the tyre and suspension characteristics of a two-axle truck. An analytical model of the tyre-suspension system was proposed and parameter values for the truck were determined from a numerical simulation of the vehicle dynamic tests. A sample application with the measured vehicle properties incorporated into a simulation of bridge response with vehicle braking is also given.

RÉSUMÉ

Des essais statiques et dynamiques ont été effectués pour déterminer les caractéristiques de pneus et de suspension d'un camion à deux essieux. Un modèle analytique du système de suspension des roues est proposé; la valeur des paramètres du camion a été déterminée à partir d'une simulation numérique des essais dynamiques du véhicule. Un exemple est présenté, utilisant les propriétés mesurées du véhicule et les incorporant dans la simulation du comportement d'un pont sous l'effet d'un véhicule en freinage.

ZUSAMMENFASSUNG

Statische und dynamische Versuche wurden durchgeführt, um die Eigenschaften der Reifen und der Aufhängung von zweiachsigen Fahrzeugen zu messen. Unter Verwendung eines analytischen Modells des Radaufhängesystems werden die Parameterwerte für das getestete Fahrzeug durch eine numerische Simulation des dynamischen Versuches ermittelt. Eine Anwendung der gemessenen Fahrzeugeigenschaften, bei einer Simulation des Brückenverhaltens mit einem bremsenden Fahrzeug, wird aufgezeigt.



1. INTRODUCTION

The dynamic loading of bridges by vehicles is affected by dynamic response of the vehicle, bridge response, and roadway roughness. An analysis of response of a bridge - vehicle system and prediction of bridge dynamic loading requires a knowledge of the various system properties involved. Bridge properties can usually be obtained more easily than vehicle properties, especially vehicle suspension properties. However, suspension properties are significant parameters in the analysis and in any particular application it is important that they be represented with reasonable accuracy. The present work was undertaken to obtain specific data on the suspension systems of a vehicle to be used in a comparison of prediction with experiment in the dynamic loading of a bridge. Vehicle suspension properties have been measured by others, eg Fenves et al [1], Winkler [2], Whittemore et al [3], and some data for typical vehicles are available, eg Huang and Veletsos [4], Walker and Veletsos [5]. The model for vehicles suspensions developed herein to conform with the measured data is similar to that used by Veletsos and Huang [6] at the University of Illinois during the 1950's and 1960's, but with some modifications.

What follows is a summary of tests which were conducted to determine some vehicle dynamic properties, especially suspension and tyre force-displacement relations and damping characteristics of a vehicle which was used as the load unit for an experimental study of bridge dynamic response with vehicle braking. The test vehicle was an International ACCO-1950A truck with an extended wheelbase and tray body. This is a two-axle vehicle with a wheelbase of 4.58m and unladen mass of approximately 6000 kg. At the rear axle the suspension system consisted of leaf springs with a pair of auxiliary springs which engaged under heavy load. The front suspension consisted of leaf springs, together with hydraulic shock absorbers. For the tests the vehicle was relatively heavily loaded (total mass approximately 14 000 kg).

Two series of tests on the vehicle were made, each including both static and dynamic parts. Prior to the second series of tests the springs were dismantled and cleaned with wire brushes in order to simulate as closely as possible the "as new" condition. The tests were designed to determine the properties of the front and rear suspensions separately. Figure 1 shows the general arrangement for the front suspension tests in which the truck was pivoted on a "rigid" frame supporting the rear axle. The rear brakes were released to allow free rotation, and vertical deformation in the rear suspension prevented. Load cells under the front axle at the suspension springs were used to measure suspension forces. The force measured by each load cell was actually the suspension force plus half the weight of the front axle and wheels. The load cells were mounted on Teflon bearings to allow horizontal movement and thus to prevent bending strains in the load cells due to eccentric loading.

For the tests on the rear suspension a similar set-up was used, with the truck pivoted on the front axle and front suspension deformations prevented (Fig. 2).

2. STATIC TESTS

The static load-displacement characteristics of the front and rear suspensions were measured during the first series of tests. For tests on the front suspension the vehicle was set up as previously noted. A crane was used to provide lift, applied through chains attached to the chassis behind the cabin. The load on the suspension was taken from zero to fully loaded, then reduced to zero. The load was changed in increments and displacements were measured using scales mounted adjacent to targets attached to the vehicle body. Load cell strains and body displacements at the axle on either side of the truck were noted for each increment of load. A similar procedure was adopted for the rear suspension. In this case the chains were attached to a lifting beam connected to the truck

chassis behind the rear axle. The displacement curves for the individual springs at each axle are not markedly different, and curves for the total axle force vs. average displacement are plotted. The front suspension load-displacement curve is shown in Fig. 3, and that for the rear suspension in Fig. 4.

The procedure was modified for the second series of tests. Static load-displacement curves for both suspension and tyres were obtained. For the rear suspension and tyre measurements chains were attached to a lifting beam behind the rear axle. Lift was provided by a crane and the lifting force was measured with a PIAB dynamometer connecting the crane hook to the chains. The load on the axle was taken from zero to fully loaded, then reduced to zero in increments. The vertical position of the axle and truck chassis above the axle on either side of the truck were noted. The procedure was repeated for the front axle with the chains attached to the chassis immediately behind the cabin. Suspension and tyre load-displacement curves for front and rear axles are given in Figs. 5 and 6 respectively.

Load-displacement measurements were also made with load cells under the suspension springs and with LVDT's (Linear Variable Differential Transformer displacement transducers) located approximately midway between the axles. Continuous records of load cell strains and LVDT displacements were recorded on an oscillograph. Figures 7 and 8 show quasistatic load-displacement curves obtained in this way for the front and rear suspensions respectively.

3. DYNAMIC TESTS

Dynamic load-displacement relations for the vehicle suspensions were determined by a series of dynamic "drop tests". The test was designed to make the vehicle behave as a single degree of freedom system undergoing free-vibration after release from an initial displacement.

As in the static tests, for a "front drop" the truck was pivoted about the rear axle and sprung by the front suspension. The front axle was mounted on load cells. Displacements of the body were measured using an LVDT at the front of the tray on each side of the truck. Each LVDT was mounted on a stand beside the truck, and the core was spring-connected to the stand and connected to the truck by an "inextensible" cable. In each drop test the front of the truck was

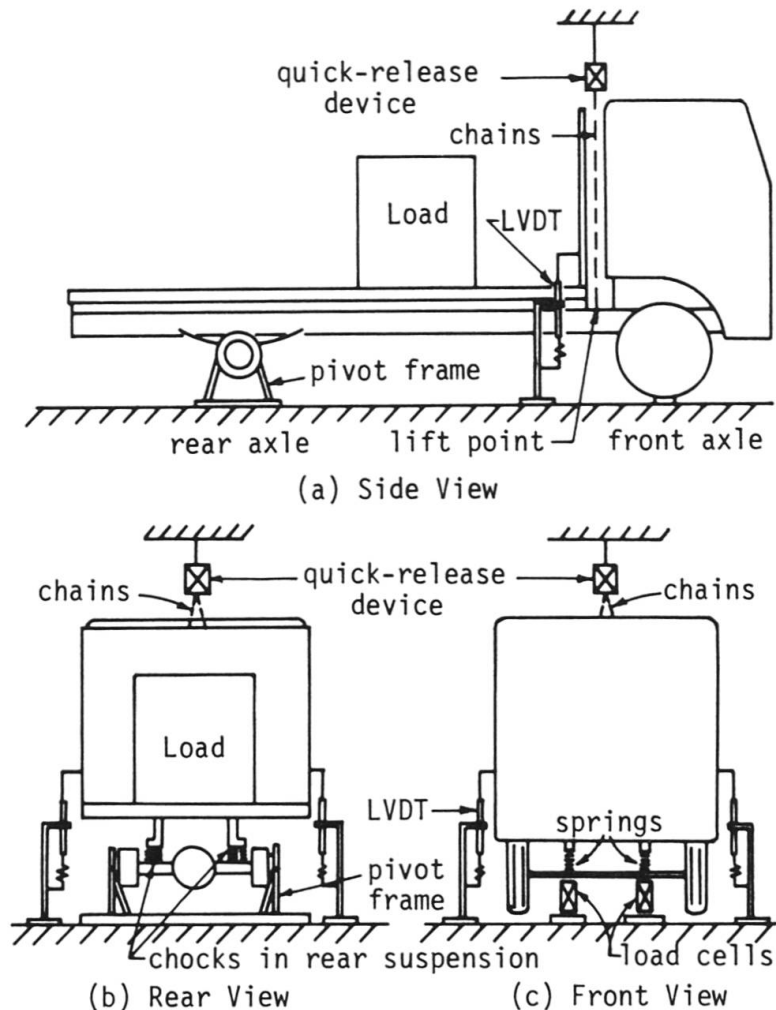

FIG. 1 GENERAL ARRANGEMENT OF TEST VEHICLE FOR FRONT SUSPENSION DYNAMIC TESTS.

lifted by crane to a predetermined initial displacement, thus partially relieving the load on the front suspension. A quick-release device was used in initiating the drop in order to ensure a "clean" start. Displacements and strains after release were recorded on an oscillograph. For tests on the rear suspension the procedure was similar, with the truck pivoted about the front axle and the front suspension blocked.

The test procedure was the same for both series of tests, except that during the second series a "quasi-static unload and reload" was made after each dynamic test. Load cell strains and LVDT displacements were continuously recorded as the axle load was taken from the final rest load to zero load and then returned to fully loaded. Dynamic drop tests were conducted for a range of initial

displacements for both front and rear suspension. Figure 9 shows typical dynamic load-displacement curves. The curves represent total axle force vs. average suspension displacement, and the quasi-static unload and reload curves are also included in the runs of the second series.

Unsuccessful attempts were made to apply torque to the axles. This was attempted in order to simulate more closely the condition of the suspension springs during braking. Torque at the axles is expected to cause a stiffening of the suspension as the springs "bind".

The mean load on the rear suspension is reduced under braking, it is therefore, of interest to investigate load-displacement relations at the rear suspension for "inverted drop" conditions. To simulate this, a "pulldown test" was attempted. A weight over the rear axle was removed in order to reduce the static suspension load to the expected mean load under braking. The rear of the truck was then pulled down by a chain running from the rear of the tray via a pulley on the floor of the laboratory to the quick-release device. Displacements and loads were measured as for the drop tests. However, because of flexibility in the vehicle body these tests were not considered successful.

4. DISCUSSION OF TEST RESULTS

The hysteresis in the load-displacement curves is attributed mainly to losses caused by friction between the leaves of the suspension springs and, for the

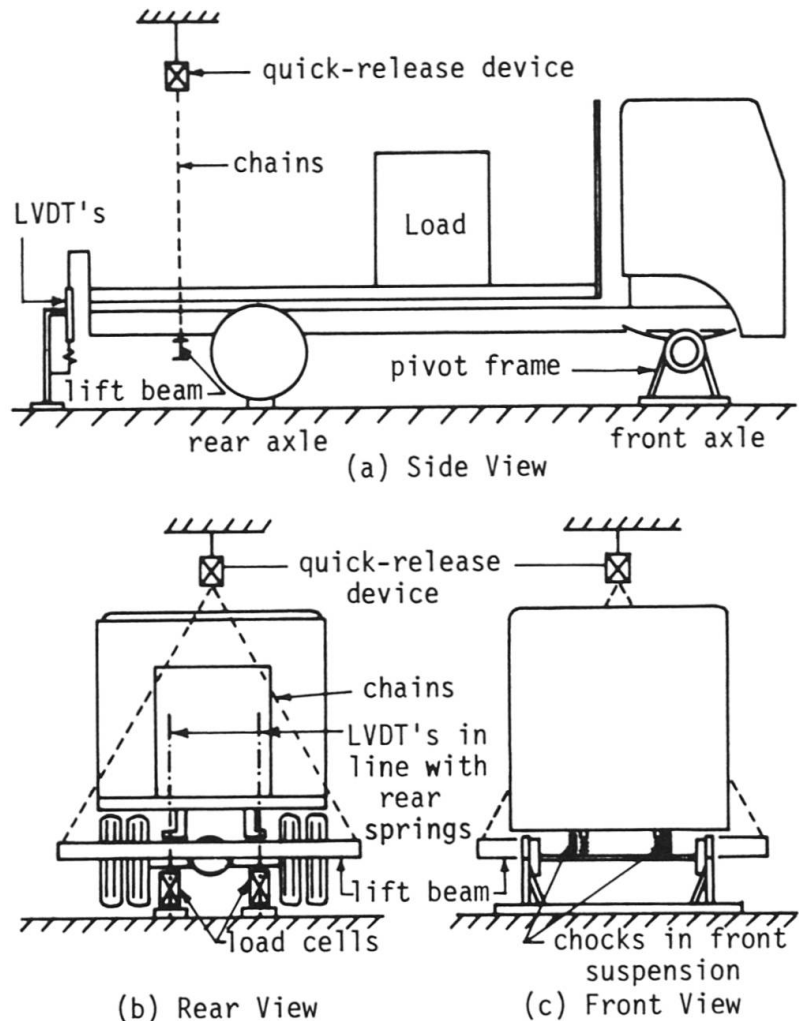

FIG. 2 GENERAL ARRANGEMENT OF TEST VEHICLE FOR REAR SUSPENSION DYNAMIC TESTS.

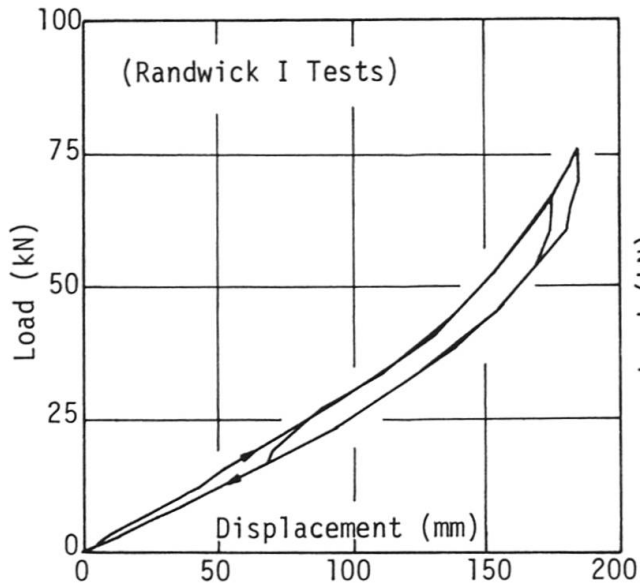

FIG. 3 FRONT SUSPENSION LOAD-DISPLACEMENT CURVE.

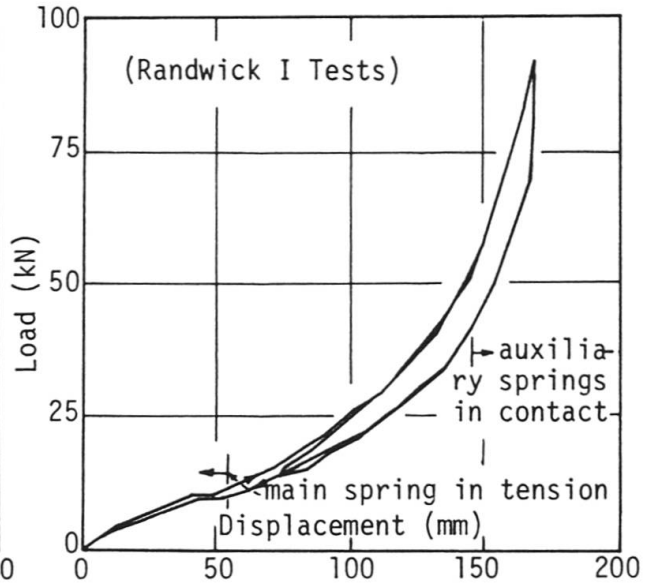

FIG. 4 REAR SUSPENSION LOAD-DISPLACEMENT CURVE.

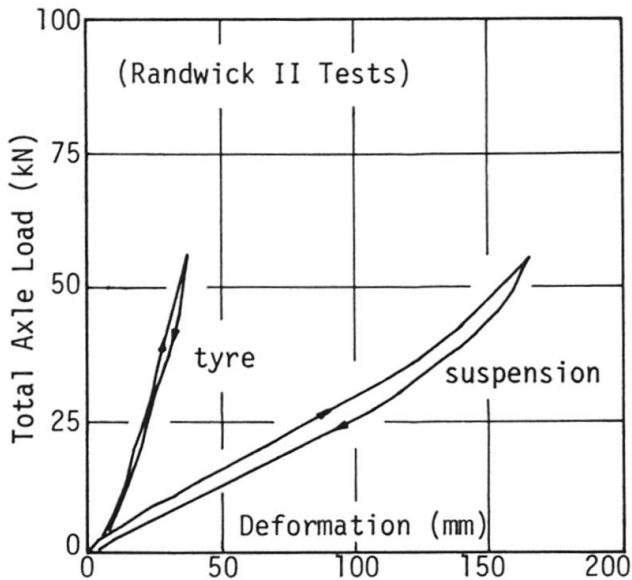

FIG. 5 FRONT STATIC TYRE & SUSPENSION LOAD-DEFORMATION CURVES.

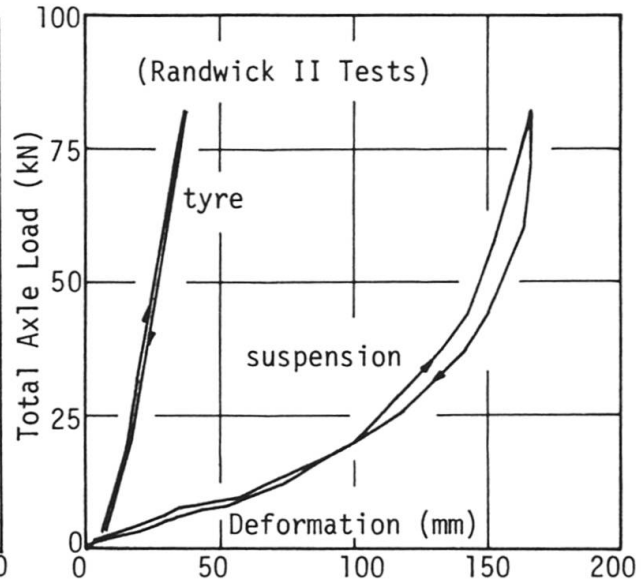

FIG. 6 REAR STATIC TYRE & SUSPENSION LOAD-DEFORMATION CURVES.

front suspension, dissipation in the hydraulic shock absorbers. From the static curves and quasi-static curves it can be seen that the "loading" and "unloading" paths are well defined. The average friction properties of the suspensions can be obtained from these curves with the limiting value of friction force as one half the difference in load between the loading and unloading portions of the curves. From the experimental curves it can be seen that the friction limit depends on the suspension deformation.

From a comparison of the dynamic load-displacement curves of the second series of tests with the corresponding static load-displacement curves it seems that there is a dynamic friction limit which is greater than the static friction limit. Similarly, the quasi-static and dynamic load-displacement curves exhibit greater hysteresis than the static curves. The differences between the dynamic load-displacement curves and the quasi-static unload and reload curves for the front suspension tests were assumed to be due to the viscous damping effect of the hydraulic shock absorbers. For the rear suspension tests there was

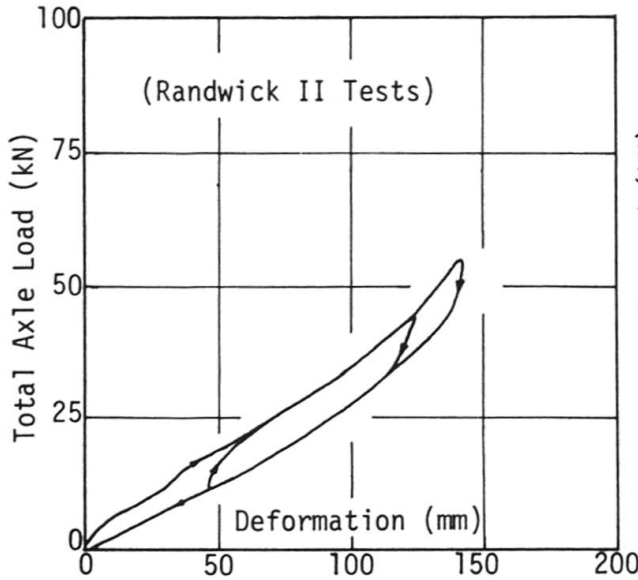

FIG. 7 FRONT SUSPENSION QUASISTATIC LOAD-DEFORMATION CURVE

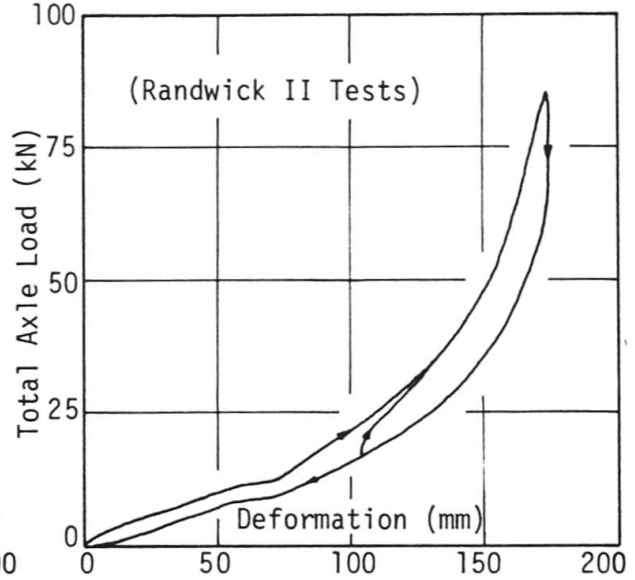

FIG. 8 REAR SUSPENSION QUASISTATIC LOAD-DEFORMATION CURVE

no obvious viscous effect - the dynamic load-displacement curves were found to follow or oscillate about the quasi-static curves. The dynamic friction limit is taken to be equal to the friction limit obtained from the quasi-static tests. The amount of spring friction was less for the later series of tests. Cleaning of the springs was taken to be responsible for this.

5. SIMULATION OF THE DYNAMIC TESTS

A suspension mathematical model was developed using the results of the vehicle tests. The performance of the suspension model has been evaluated using a simulation of the dynamic "drop test".

The idealised tyre-suspension system is shown in Fig.10. The tyres are represented as a linearly elastic spring of stiffness k_t . The assumption of linearity is justified by the results of the vehicle tests (Figs. 5 and 6). The values of tyre stiffness obtained from these tests are the nonrolling tyre spring rates. It is recognized that differences exist between the nonrolling and rolling rates. However, Whittemore et al.[3] in their pavement load studies found that a vehicle model using the nonrolling rate showed good correlation with measured data indicating that the difference between rolling and nonrolling tyre rates was not an important factor in the simulation.

Each suspension system is idealised as the parallel combination of a suspension spring, a viscous damper, and a friction device in series with a spring (called the "friction" spring). Figure 11 defines the tyre-suspension force variations \bar{P}_s , \bar{P}_t , P_s , P_v and P_f . In general, the suspension spring is nonlinearly elastic and the friction spring is linearly elastic with stiffness k_f . The limiting value of the load carried by the friction device (friction limit F_1) is approximately linearly proportional to the suspension spring force variation P_s .

The governing relations of the suspension model are:

$$F_1 = F_{10} + \zeta P_s \quad (1)$$

$$\bar{P}_s = P_s + P_f + P_v \quad (2)$$

$$P_s = \text{a function of } u_s \quad (3)$$



$$P_v = c \dot{u}_s \quad (4)$$

$$P_f = k_f(u_s - u_f) \quad (5)$$

$$-F_1 \leq P_f \leq F_1 \quad (6)$$

where

u_s = suspension deformation

$\dot{u}_s = du_s/dt$ = suspension time rate of deformation

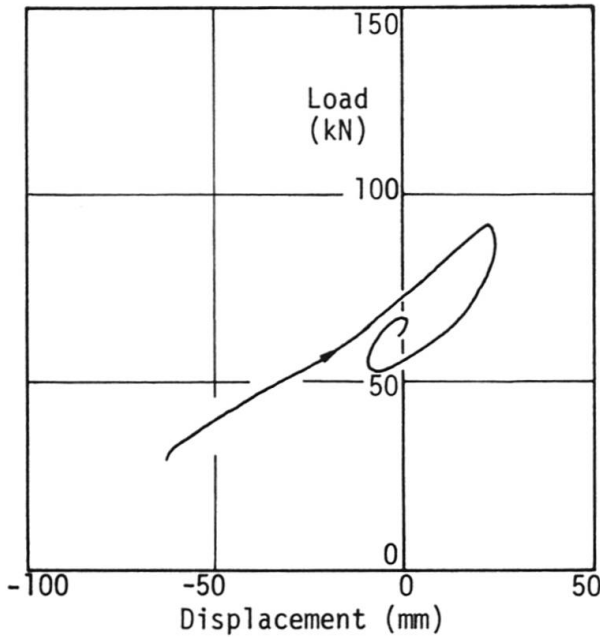

(a) Front Suspension (First Test Series-Randwick I)

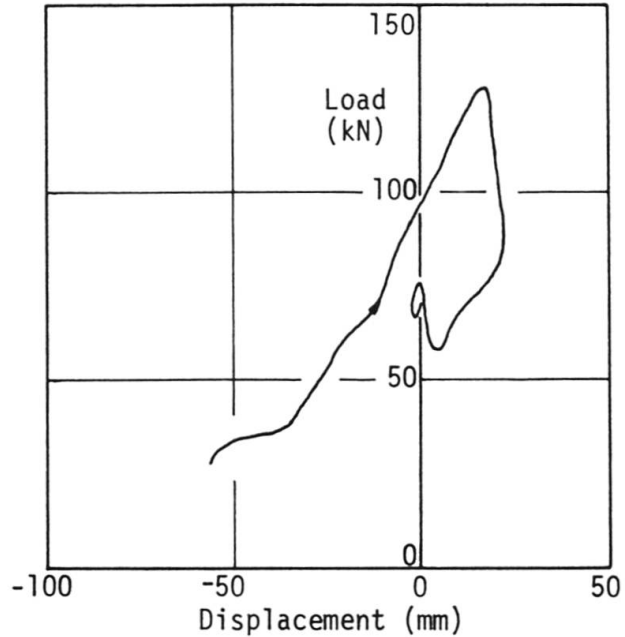

(b) Rear Suspension (First Test Series-Randwick I)

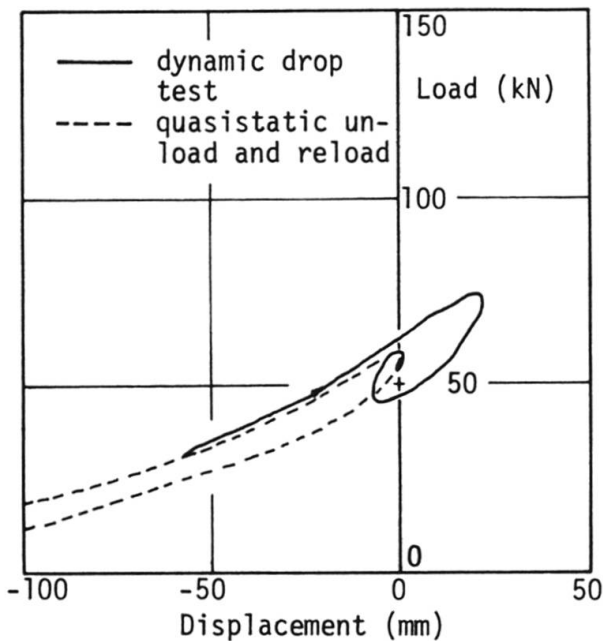

(c) Front Suspension (Second Test Series-Randwick II)

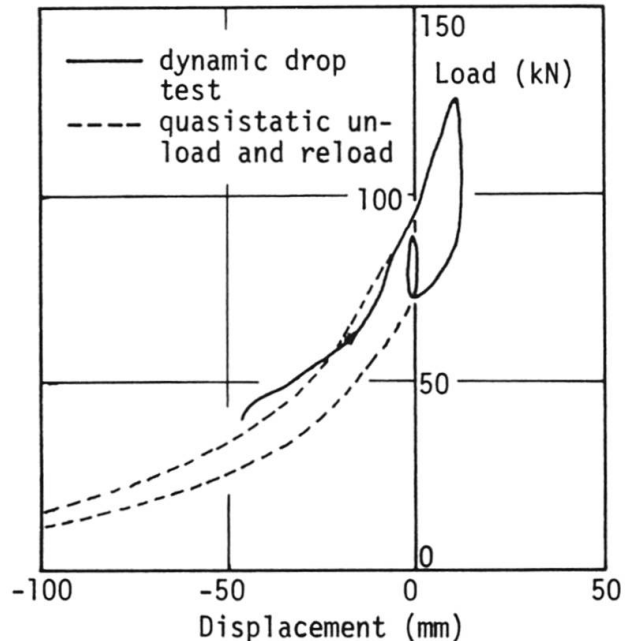

(d) Rear Suspension (Second Test Series-Randwick II)

FIG. 9 TYPICAL DROP TEST LOAD-DISPLACEMENT CURVES

- u_f = slippage of the friction device
- c = viscous damping constant
- F_{10} = friction limit at zero suspension deformation
- ζ = hysteretic damping constant

Values for F_{10} and ζ are obtained from the quasi-static load-displacement curves.

To evaluate the performance of the suspension model a numerical simulation of the drop test was programmed for digital computer. The vehicle was modelled as a rigid body, with mass M_V and pitching moment of inertia I_V about the centroid, pivoted about one axle and sprung by the suspension at the other axle. The parameters a_1, a_2, b_V and s_x are defined in Fig. 12.

Exponential curves of the form

$$P_s = A (\exp(B u_s) - 1) \quad (7)$$

where A and B are constants, were found to give satisfactory approximations to the quasi-static load-displacement curves of the second series tests. For the rear suspension it was necessary to approximate the experimental curve by a two stage piecewise curve of the form of Eq. 7. The expressions for the suspension spring load-displacement curves and the friction parameters ζ and F_{10} for the front and rear suspension are:

Front:

$$\left. \begin{aligned} P_s &= 7 \times 10^4 (\exp(9 u_s) - 1) \text{ N} \\ \zeta &= 0.08 \\ F_{10} &= 5 \times 10^3 \text{ N} \end{aligned} \right\} (8)$$

Rear:

$$\left. \begin{aligned} P_s &= \begin{cases} 7 \times 10^4 (\exp(34.6 u_s) - 1) \text{ N} & \dots u_s < -0.03 \text{ m} \\ 14 \times 10^4 (13.0 u_s - 1) \text{ N} & \dots u_s > -0.03 \text{ m} \end{cases} \\ \zeta &= 0.15 \\ F_{10} &= 12.5 \times 10^3 \text{ N} \end{aligned} \right\} (9)$$

A comparison of the idealised load-displacement curves with the experimental curves is given in Fig. 13. The radius of gyration of the vehicle body and load

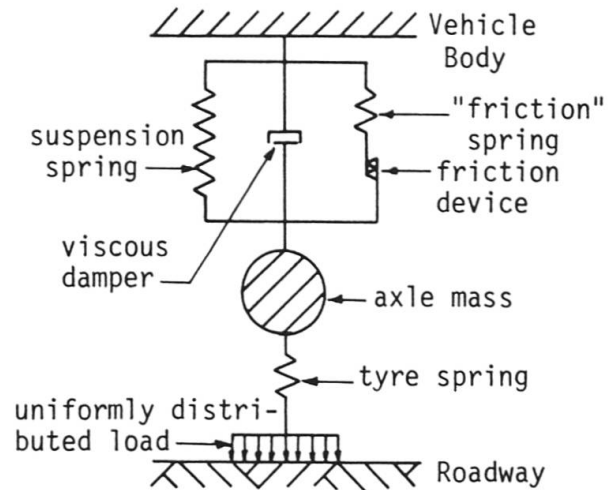

FIG. 10 VEHICLE TYRE-SUSPENSION REPRESENTATION

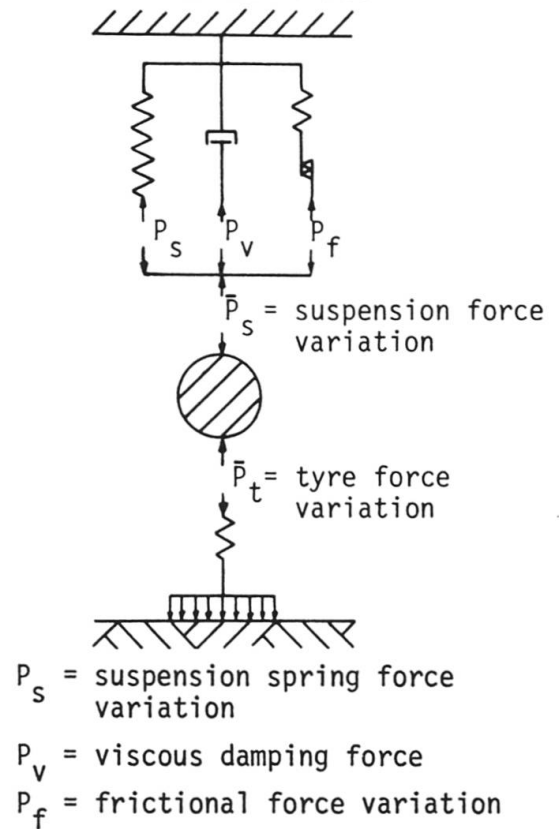

FIG. 11 DEFINITION OF TYRE-SUSPENSION FORCE VARIATION

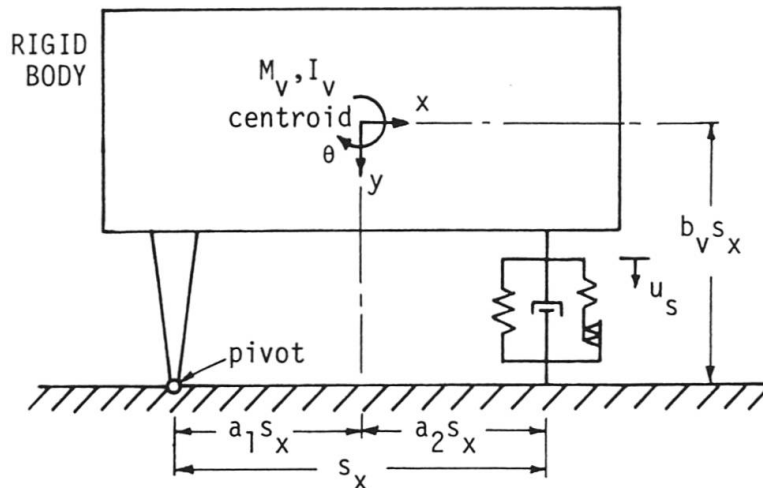

FIG. 12 SINGLE DEGREE OF FREEDOM VEHICLE IDEALISATION FOR THE DROP TEST SIMULATION.

was assumed to be $0.4s_x$, and the friction stiffness k_f for each suspension was estimated from the frequency of vibration at small deformation obtained in the experimental drop tests.

Drop test simulations were conducted for a range of drop heights for both the front and rear suspensions. The viscous damping constant, c , was varied until a reasonably good simulation was obtained.

With the following vehicle parameters known,

$$\begin{aligned} M_V &= 12800 \text{ kg} & s_x &= 4.58 \text{ m} \\ I_V &= 4 \times 10^4 \text{ kg m}^2 & b_V &= 0.2 \end{aligned}$$

the suspension parameters were found to be:

<u>Front</u>	<u>Rear</u>
$a_1 = 0.39$	$a_1 = 0.61$
$k_f = 1.3 \times 10^6 \text{ Nm}^{-1}$	$k_f = 4.6 \times 10^6 \text{ Nm}^{-1}$
$c = 1.5 \times 10^4 \text{ Nm}^{-1} \text{ s}$	$c = 2.5 \times 10^4 \text{ Nm}^{-1} \text{ s}$

Figures 14 and 15 show load and displacement history curves and load-displacement curves for typical front and rear drop test simulations respectively. The corresponding experimental curves are superimposed. The loads are the total suspension loads at an axle. The experimental curves have the weight of the wheels and axle assembly subtracted from the measured loads. The mass of the wheels and axle assembly is taken as 450 kg for the front axle and 860 kg for the rear axle. Also the experimental curves have displacements relative to the final "rest" position, while the simulation has zero displacement corresponding to zero suspension spring force.

The results of the simulations of the front suspension tests were better than those for the rear. The peak force was over-estimated for all drop test simulations, but the discrepancy was greater for the rear tests. The viscous damping component which was included in the simulations of the rear suspension tests so as to obtain the best overall correlation between simulation and experiment distorts the shape of the load-deflection curves (there is no apparent viscous com-



ponent in the experimental curves for the rear suspension tests). It is assumed that energy is dissipated only by damping in the suspensions. Dissipation of energy elsewhere such as relative movement in the body of the vehicle may have been a significant contributing factor in the discrepancies between tests and simulation.

6. SAMPLE APPLICATION TO BRIDGE LOADING STUDIES

A method for the calculation of dynamic response of single span multi-girder bridges due to loading by a single two-axle vehicle has been presented by

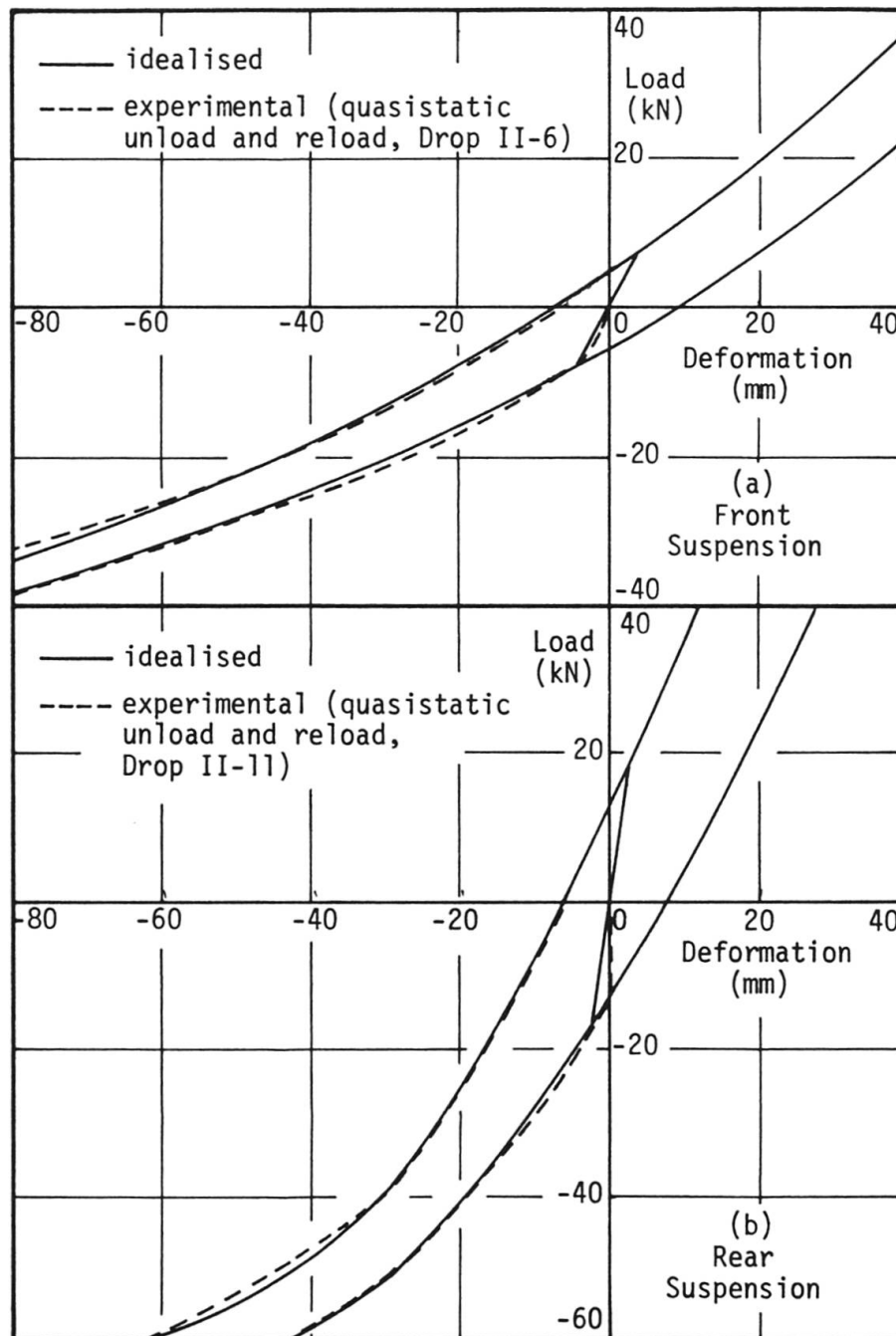

FIG. 13 COMPARISON OF IDEALISED AND EXPERIMENTAL QUASISTATIC LOAD-DEFORMATION CURVES

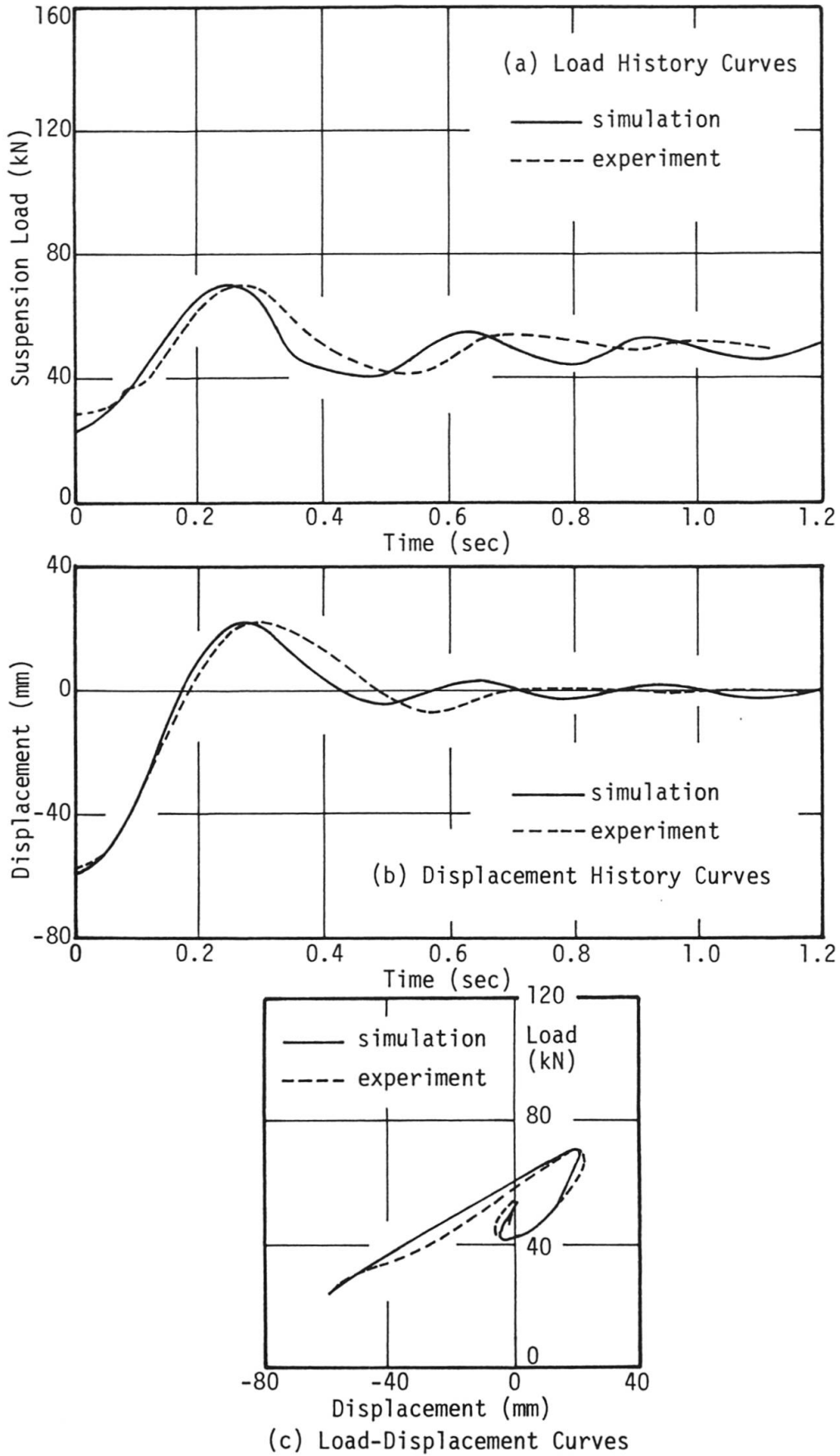
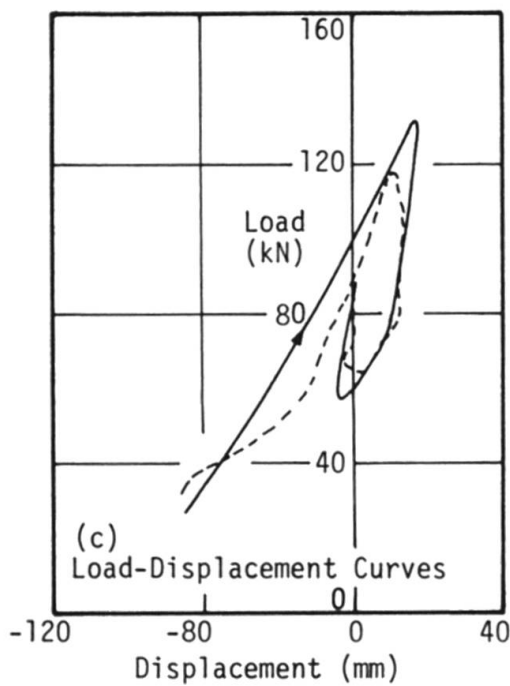
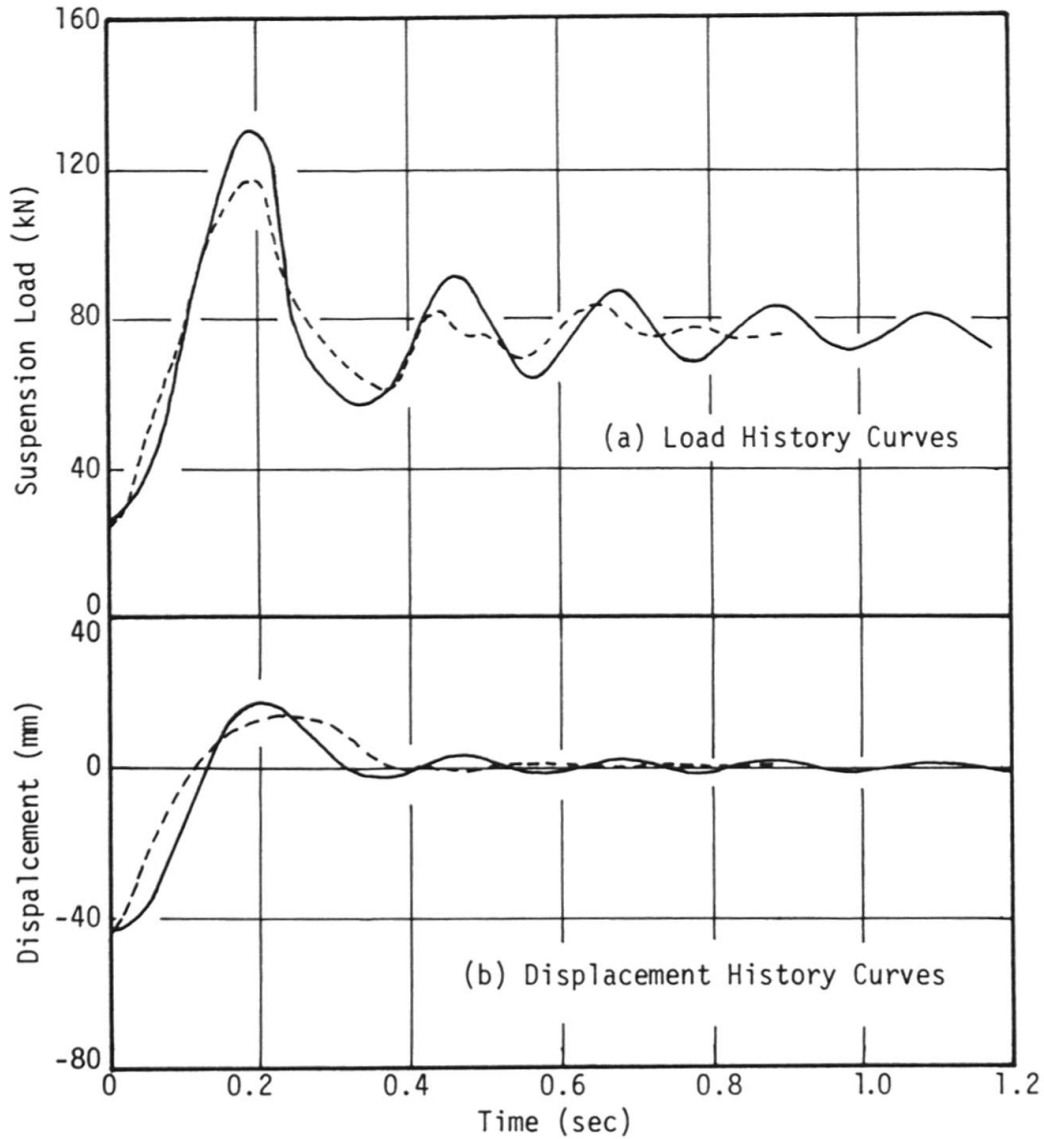
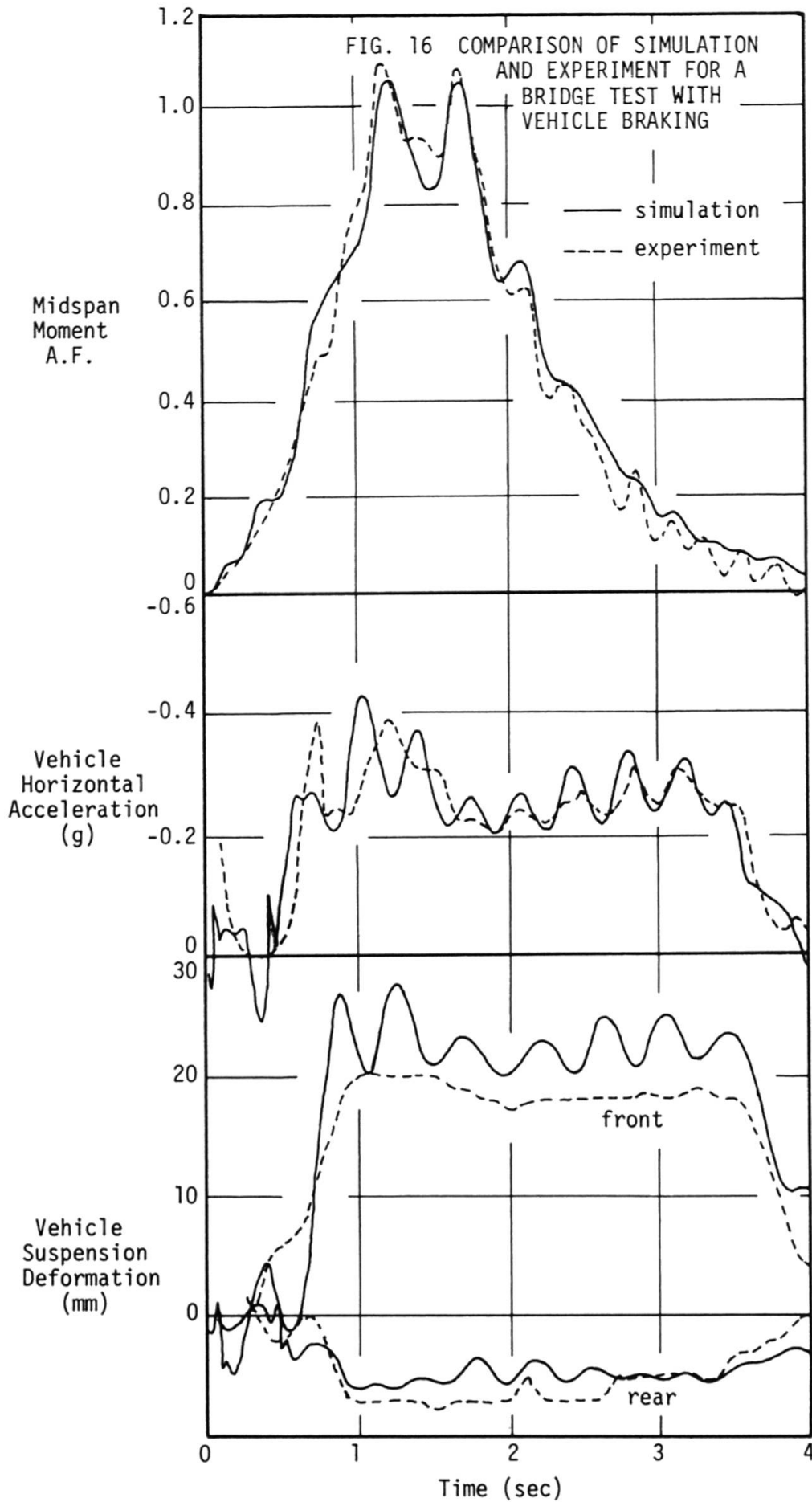

FIG. 14 COMPARISON OF TYPICAL FRONT SUSPENSION EXPERIMENTAL AND SIMULATION CURVES.



Legend:
 — simulation
 - - - experiment

FIG. 15 COMPARISON OF TYPICAL REAR SUSPENSION EXPERIMENT AND SIMULATION CURVES





Mulcahy et al.[7], Mulcahy et al.[8]. The bridge is idealised as a rectangular plate simply supported on two opposite sides and free on the other two sides. Higher order finite strips [9] are used to model the plate. The analysis takes account of vehicle acceleration or braking, road roughness and eccentric placement of the vehicle on the bridge. The tyre-suspension system as described previously is incorporated in the vehicle model.

Experimental tests were conducted which involved the sudden braking of the vehicle on the bridge. The test span of length 26.4 m was the first span of a two lane and three span bridge. Each span was simply supported and consisted of eight prestressed concrete inverted T-girders, placed side by side, and acting compositely with a reinforced concrete deck. The road surface profile at bridge entry was measured. Bridge midspan longitudinal bending strain, vehicle forward acceleration, vehicle suspension deformations, and the times at which the vehicle entered the bridge and passed the nominal braking point were recorded. Bending strain values were normalised with respect to the maximum value obtained from a "crawl" run. This defines the bridge bending moment amplification factor (A.F.). A complete description of the test procedure and presentation of results is given by Mulcahy et al.[8].

A comparison of history curves for bridge midspan bending moment, vehicle forward acceleration and vehicle suspension deformations obtained from the numerical simulation and from experiment for one test run are presented in Fig. 16. Although deficiencies of the model were apparent from the results of the simulations of some tests, the curves of Fig. 16 are very encouraging.

7. CONCLUSIONS

An experimental study of load-displacement relations for the front and rear suspensions of a two-axle truck are described, involving static, quasi-static and dynamic loading. A mathematical model to describe the suspensions in studies of vehicle and highway bridge interaction is formulated. In simulations incorporating this model reasonable agreement was achieved with the vehicle laboratory experiments. Use of the suspension in a simulation of vehicle-bridge interaction when vehicle braking is involved also shows reasonable correlation with experiment. It is concluded that while the results achieved are promising, there is a need to improve the present method for evaluating and simulating the suspension properties of vehicles. Such evaluation is important in the study of dynamic loading by vehicles.

8. ACKNOWLEDGEMENTS

The work reported herein was carried out as part of the Australian Road Research Board project, "Effects of Vehicle Braking on Dynamic Loading of Bridges". The authors gratefully acknowledge the assistance of the following: Mr. J Walter, for the arrangement and conduct of tests; Mr. M. Norman, for the instrumentation; and members of the staff of Civil Engineering Structures Laboratory of the University of New South Wales. The authors are also very grateful to the Department of Main Roads (NSW), for providing the truck, and its handling and servicing. Finally, the participation of Dr. N L Mulcahy was made possible by a Commonwealth Post-Graduate Research Award.

9. REFERENCES

- [1] FENVES, S.J., VELETOS, A.S. and SIESS, C.P., Dynamic Studies of Bridges on the AASHO Test Road Hwy. Res. Bd., Special Rep. 71, Nat'l. Acad. Sci., Washington, D.C., 1962.
- [2] WINKLER, C.B., Measurement of Inertial Properties and Suspension Parameters



of Heavy Highway Vehicles. Society of Automotive Engineers, SAE 730192, Int. Automotive Engrg. Congress, Detroit, Michigan, Jan. 8-12, 1973.

- [3] WHITTEMORE, A.P., WILEY, J.R., SCHULTZ, P.C. and POLLOCK, D.E., Dynamic Pavement Loads of Heavy Highway Vehicles. Appendix S, National Co-operative Highway Research Program, Hwy. Res. Bd., Report 105, Washington, D.C., 1970.
- [4] HUANG, T. and VELETSOS, A.S., Dynamic Response of Three-Span Continuous Highway Bridges. Civ. Engrg. Studies, Struct. Res. Series, No. 190, Univ. of Illinois, Urbana, Illinois, 1960.
- [5] WALKER, W.H. and VELETSOS, A.S., Response of Simple Span Highway Bridges to Moving Vehicles. Engrg. Expt. Stn. Bulletin 486, University of Illinois, Urbana, Illinois, 1966.
- [6] VELETSOS, A.S. and HUANG, T., Analysis of Dynamic Response of Highway Bridges. A.S.C.E., J. Eng. Mech. Div., 96, EM5, October, 1970.
- [7] MULCAHY, N.L., PULMANO, V.A. and TRAILL-NASH, R.W., Dynamic Response of Bridge Decks to Vehicle Loads by the Finite Strip Approach. Proceedings of the Third International Conference in Australia on Finite Element Methods, Univ. of New South Wales, Kensington, N.S.W., Australia, 1979.
- [8] MULCAHY, N.L., PULMANO, V.A. and TRAILL-NASH, R.W., Effects of Vehicle Braking on the Dynamic Loading of Bridges. UNICIV Report No. R-191, Univ. of New South Wales, Kensington, N.S.W., Australia, 1980.
- [9] CHEUNG, M.S. and CHEUNG, Y.K., Static and Dynamic Behaviour of Rectangular Plates Using Higher Order Finite Strips. Building Science, Vol. 7, 1972.