

Session 3: Applications and experimental verifications

Objektyp: **Group**

Zeitschrift: **IABSE reports of the working commissions = Rapports des commissions de travail AIPC = IVBH Berichte der Arbeitskommissionen**

Band (Jahr): **33 (1981)**

PDF erstellt am: **21.07.2024**

Nutzungsbedingungen

Die ETH-Bibliothek ist Anbieterin der digitalisierten Zeitschriften. Sie besitzt keine Urheberrechte an den Inhalten der Zeitschriften. Die Rechte liegen in der Regel bei den Herausgebern.

Die auf der Plattform e-periodica veröffentlichten Dokumente stehen für nicht-kommerzielle Zwecke in Lehre und Forschung sowie für die private Nutzung frei zur Verfügung. Einzelne Dateien oder Ausdrucke aus diesem Angebot können zusammen mit diesen Nutzungsbedingungen und den korrekten Herkunftsbezeichnungen weitergegeben werden.

Das Veröffentlichen von Bildern in Print- und Online-Publikationen ist nur mit vorheriger Genehmigung der Rechteinhaber erlaubt. Die systematische Speicherung von Teilen des elektronischen Angebots auf anderen Servern bedarf ebenfalls des schriftlichen Einverständnisses der Rechteinhaber.

Haftungsausschluss

Alle Angaben erfolgen ohne Gewähr für Vollständigkeit oder Richtigkeit. Es wird keine Haftung übernommen für Schäden durch die Verwendung von Informationen aus diesem Online-Angebot oder durch das Fehlen von Informationen. Dies gilt auch für Inhalte Dritter, die über dieses Angebot zugänglich sind.



Session 3

Applications and Experimental Verifications

Leere Seite
Blank page
Page vide



Applications and Experimental Verifications

Applications et vérifications expérimentales

Anwendungsbeispiele und experimentelle Bestätigungen

PETER GERGELY

Professor
Cornell University
Ithaca, NY, USA

RICHARD N. WHITE

Professor and Director
Cornell University
Ithaca, NY, USA

SUMMARY

The use of the finite element, boundary element, and plastic analysis methods in the analysis of reinforced concrete is summarized. Comparisons are presented with experimental evidence for local behavior, short-term and long-term deflections of beams and slabs, and three-dimensional behavior. The current state of knowledge in analytical methods and empirical evidence of local behavior are discussed.

RÉSUMÉ

L'application de la méthode des éléments finis, des éléments de pourtour, et de l'analyse plastique à l'étude du béton armé est résumée. Des comparaisons sont faites avec des résultats expérimentaux pour les effets locaux, les flèches — de courte et de longue durée — des poutres et des dalles et le comportement tridimensionnel. L'état actuel des connaissances sur les méthodes analytiques et les données expérimentales des effets locaux est donné.

ZUSAMMENFASSUNG

Es werden die Anwendung von finiten Elementen, von Grenzelementen und die Methoden der Plastizitätstheorie zur Analyse von Stahlbeton kurz zusammengefasst. Vergleiche mit experimentellen Ergebnissen werden gegeben, bezüglich des lokalen Verhaltens, der zeitunabhängigen und zeitabhängigen Durchbiegungen von Balken und Platten und des drei-dimensionalen Verhaltens. Der derzeitige Stand der Forschung auf dem Gebiete der analytischen Methoden und die empirischen Resultate des lokalen Verhaltens werden diskutiert.



1. INTRODUCTION

The analysis and design of reinforced concrete structures has been based on simple equilibrium conditions and empirical rules for nearly a century. These approaches generally result in safe designs but they often have inherent inconsistencies and generally are not based on a clear understanding of the actual behavior of reinforced concrete. The primary reason for this situation is that the overall performance of concrete structures depends strongly on factors such as bond, cracking, crushing, shear transfer across cracks, and time-dependent effects. Each of these actions is complex, and only recently have we come to understand these phenomena reasonably well.

An accurate analysis of reinforced concrete must be able to predict crack initiation and propagation, nonlinear compressive behavior of concrete, bond-slip, time-dependent effects, and response to repeated (and often reversing) loads. Advances during the past several years indicate that such complex analyses are feasible but that they are useful mainly for research purposes and not for routine design.

Of the several advanced analytical approaches that have been developed, the most significant are the finite element method (FEM), the finite difference method (FDM), the boundary element method (BEM), and the plastic analysis method (PAM). The vast majority of analysis developments have been based on the FEM. The BEM has great potential for the analysis of many types of reinforced concrete structures; see Section 6 of this paper.

Analysis methods and idealizations for reinforced concrete may be conveniently classified into three groups [1]: (a) microscopic models that are used to study local behavior, (b) discrete member idealizations that model individual members, and (c) macroscopic idealizations that model the entire structure or large subassemblies of it.

The last approach is useful mainly in the analysis of large structures, especially for linear behavior. Member idealization is useful in the analysis of nonlinear behavior, for structures made of dissimilar members, and in other situations. The microscopic model is necessary in the analysis of local stresses, cracking, inelasticity, and in research.

The primary purpose of this paper is to present comparisons of analytical results with experimental results. Each of the three approaches to analysis defined above will receive attention. The paper begins with a rather general statement on the boundary element method, and then proceeds on through a number of topics: local effects (bond, cracking, interface shear transfer, dowel action); beams, slabs, and curved elements under short term loading; time-dependent deformations of beams, slabs, and shells; and three-dimensional structures. The coverage is not intended to be comprehensive, but rather to provide a good indication of the state-of-the-art in analysis as seen through the ability of the various methods to predict actual response of test structures.

2. LOCAL EFFECTS

The local behavior in a reinforced concrete structure is often of crucial importance, either in a research study or in the detailed analysis and design of important structures, particularly those subject to severe load environments such as seismic or wave action. The local behavior of reinforced concrete structures under short-term loading is dependent upon five factors: (a) cracking (structural or microcracking), (b) bond slip between reinforcing

and concrete, (c) shear transfer across cracks, (d) dowel action, and (e) the nonlinearity of confined concrete under multiaxial stress states. Each of these factors may produce nonlinear behavior and hence greatly complicate the detailed analysis of a structure or structural element. The first four factors are discussed in this paper.

Although many investigations on these topics have been completed during the 20th century, most of the information generated is unsuitable for use in advanced modern analytical methods. The reason for this unfortunate fact is that the FEM, FDM, and BEM all require detailed knowledge of local behavior (such as the fundamental nature of bond-slip) rather than overall or gross effects that were of prime interest in the not-too-distant past. Therefore, many recent and current experimental programs have been concerned with local behavior, with the primary purpose of providing data that can be converted into stiffness relationships for analytical approaches.

2.1 Bond and Cracking

The FEM was used for the evaluation of bond stresses as early as 1968 [2,3]. These studies revealed the complex nature of the problem and the importance of internal cracking, slip, and shrinkage stresses. At least a dozen investigations were concerned with the finite element analysis of bond during the next decade and there are many active studies at the present time.

Most available analyses considered either an axial section of a cylindrical concrete specimen with an embedded bar, or a cross section of a beam. The initiation and propagation of cracks at low loads compares reasonably well with experimental data, although both experiments and analyses show that shrinkage stresses create significant stresses around a bar. Yet, shrinkage effects cannot be estimated with confidence.

Bond has been represented several ways in finite element analyses: using local bond-slip relationships and bond link elements [4,5], lumping the interface flexibility with a one-dimensional steel element [6,7], assuming the bond stress distribution along the bar [8], and employing a bond layer or shear element [9,10]. All of these approaches have given reasonable results in particular cases [53].

Perhaps the most promising analytical representation of bond involves the use of interface elements in FEM or in BEM. Such elements have been used with success in rock mechanics. The results of one analysis of bond using interface elements are compared with experimental evidence in Fig. 1 [9]. The work was extended to cyclic loading; the calculated bond-slip curves simulate the experimental degrading hysteresis curves reasonably well.

In an analytical study of tension specimens, Labib and Edwards [11] used two-dimensional finite elements, nonlinear bond-slip curves, and linkage elements to predict the development of cracking. They traced the formation of longitudinal cracks and transverse (primary and secondary) cracks and the results compare well with experimental evidence obtained by Broms. One set of comparisons is shown in Fig. 2. Although the steel stress-strain curve was idealized as multilinear, the concrete was assumed to be linear elastic. One of the interesting results of the analysis was that the order of formation of cracks depends on the stress gradient (eccentricity of load). The steel stress distribution was found to be nearly uniform along the tension member at relatively low steel stress levels (at or above about 200 MPa).

Unfortunately, the properties of concrete subjected to high-level multi-axial stresses is not known and this hinders the proper modeling of concrete around

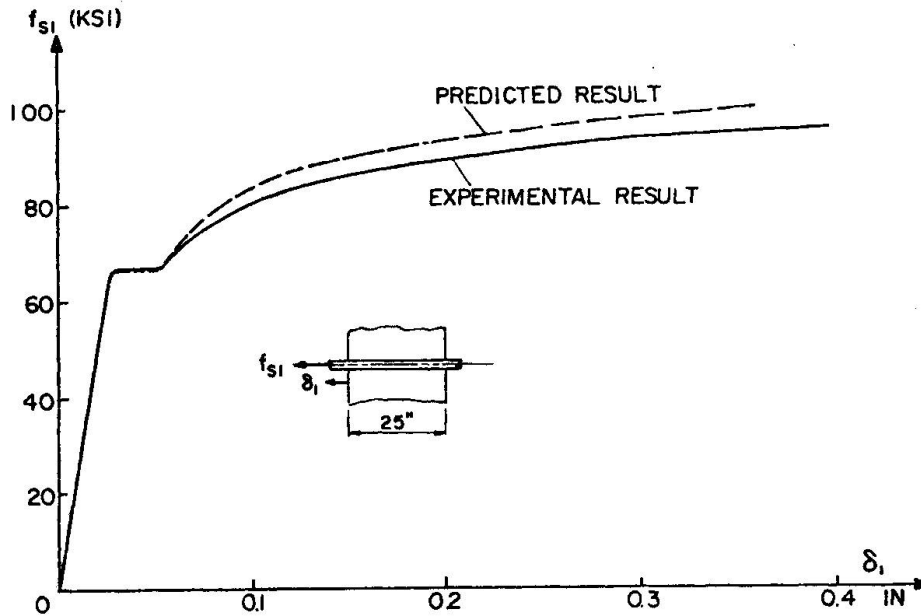

#8 Pull Only, 25 in. Column (Specimen No. 7)

Fig. 1 Analytical Prediction vs. Experimental Results for Monotonic Loading

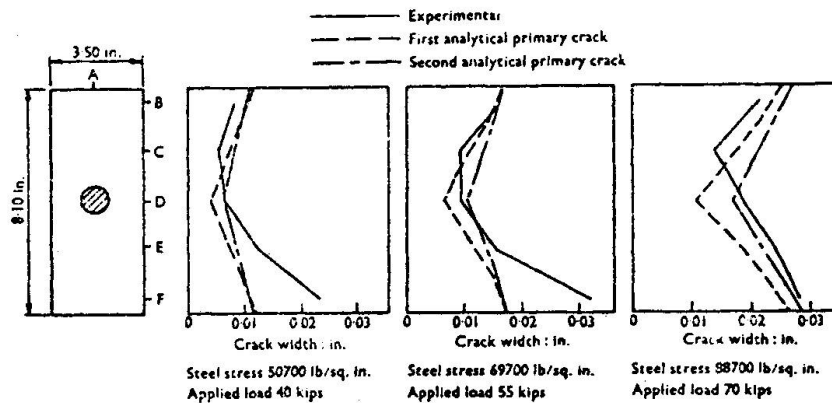

Fig. 2 Primary Crack Width; Member T-RC2

a reinforcing bar when it crushes in front of the bar ribs. The situation is further complicated when the load is repeated or reverses because then the slip involves nearly free movement of the bar between compacted concrete on either side of each bar rib. Thus current analyses are most accurate at intermediate loads: after shrinkage effects become negligible and before crushing at bar ribs occurs. It is likely that further analytical and experimental development will enable the analysis of bond effects in reinforced concrete up to failure and for repeated loading.

Recent developments in bond analysis include a program developed at Cornell University to trace the initiation and propagation of internal and primary cracks and to account for the nonlinear behavior of concrete in front of bar ribs, both for monotonic and for reversed loading. Preliminary results are encouraging.

A number of investigations have been conducted on the stresses and cracking around anchored bars or spliced bars. Instead of studying the bond-slip along the bar, beam cross sections were analyzed in which the bars were replaced by internal pressure [12,13,14]. The purpose of these analyses was to evaluate the splitting resistance of concrete for various cover and bar spacing values. The effects of stirrups have been studied only to a limited extent [14]. However, direct comparison with experimental results is not available.

The theory of plasticity has been used to calculate the anchorage capability of bars [15]. The concrete is assumed to be rigid-plastic but a concrete effectiveness factor is introduced. Preliminary results agree well with experimental data as can be seen in Fig. 3. As with most other plastic analysis methods, the value of the concrete effectiveness factor cannot yet be evaluated independently.

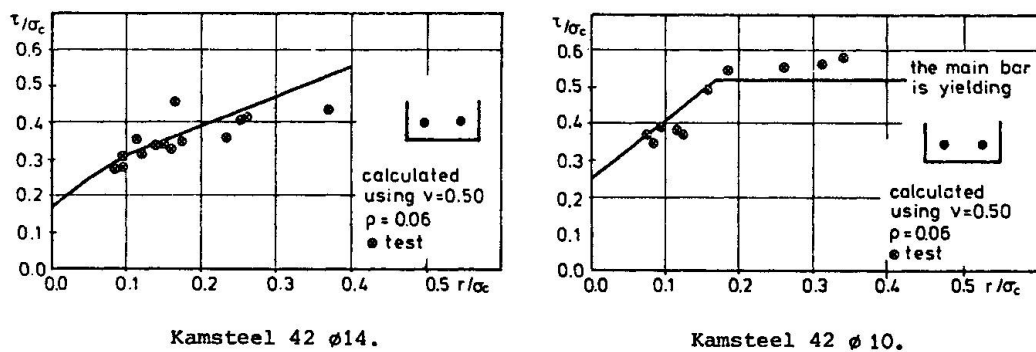

Fig. 3 Comparison Between Tests and Calculation

In summary, it is seen, that three types of bond analyses have been made: (a) axisymmetric analyses of a region around a bar, (b) using bond idealizations in two-dimensional analyses of beams, and (c) analyses of beam cross sections for splitting effects. These problems are usually represented with two-dimensional (including axisymmetric) finite element idealizations, but experiments show that radial-axial cracks appear at low steel stresses (at about 40 MPa) which invalidate the assumption of axisymmetry. It is expected that many more three-dimensional analyses by the FEM or the BEM will be performed in the near future.

2.2 Prediction of Cracking by Fracture Mechanics

Fracture mechanics theory has had relatively little application in reinforced concrete analysis methods, but this situation is now changing quite rapidly. Embedded into a finite element analysis approach that uses singular elements [16], fracture mechanics concepts provide great potential for an improved capability to predict crack initiation and propagation in all types of reinforced concrete structures.

Ngo [17] was the first investigator to attempt to solve the problems associated with discrete crack modeling in finite element analysis (using a strength criterion for crack extension calculations). He also presented a simple algorithm for evaluating the energy release rate, G , and formulated a model for the elasto-plastic deformation around the tip of a crack.

Argyris, Faust, and William [18] analyzed a pressurized thick-walled concrete ring by two approaches -- a smeared crack representation with a strength



criterion for crack extension, and a discrete crack representation using a fracture mechanics criterion to determine crack extension. They show that the first criterion is inadequate because the stress singularity is affected by the coarseness of the finite element mesh.

Moder [51] formulated an approach utilizing a small microcracked zone ahead of the actual crack in the so-called Fictitious Crack Model, and solved pure mode I cracking problems. In this approach it is postulated that most of the released energy is absorbed by the microcracked zone at the tip of the crack. Bazant and Cedolin [19] used a crack stability criterion based on the energy release rate, G , to analyze a centrally cracked reinforced concrete plate. They attempted to derive an expression for G which accounted for the reinforcement in the uncracked concrete. The entire released energy was assigned to the creation of new surface energy. Studies showed that convergence was a strong function of the bond slip relation used in the formulation. The approach is restricted to pure mode I problems.

Saouma [10] presents an analysis procedure that automatically simulates discrete crack nucleation and extension, with the length of the crack being governed by a fracture mechanics criterion. New finite element meshes are generated automatically by the computer as the crack progresses and are displayed by computer graphics. The fully interactive nature of the program permits the user to better control the analysis as it progresses. The analysis uses isoparametric quadrilateral and triangular elements for concrete and for the main reinforcing steel, truss elements for stirrups, interface elements for modeling both bond and interface shear transfer at cracks, and a singular element to model the stress singularity at the crack tip.

Saouma's analysis is the first to handle mixed mode problems as well as the simpler Mode I type of crack. As currently structured, the program can handle up to 10 discrete cracks with simultaneous automatic propagation of each. The extensive amount of re-analysis involved with the continuously changing finite element meshes is made feasible by using a mesh optimizer and a skyline band matrix solver.

Comparison of analysis results with the actual behavior of a reinforced concrete beam tested by Bresler and Scordelis is given in Fig. 4. The initial finite element mesh is shown in Fig. 4a and the final mesh is given in Fig. 4b.

2.3 Interface Shear Transfer and Dowel Action

The interface shear transfer (IST) mechanism across cracks is significant in many types of structures: shear walls, corbels, beams, cracked containment shells subjected to earthquake loading, and in all cases where crack surfaces tend to move tangentially relative to each other. For example, without IST, cracks do not propagate in the expected directions in beams loaded in shear.

The simplest method of accounting for IST, which is sometimes sufficient, is to assign a constant reduced shear modulus along the smeared crack. However, in many cases a better representation of IST is necessary. Several experimental investigations have produced curves for the determination of the shear stiffness as a function of the crack width, transverse reinforcement, load history, and concrete properties. Extensive work was done at several universities (Delft, Cornell, Washington, Christchurch). These results, however, are only useful for discrete crack models.

A model of normal and shear force transfer across cracks has been developed which includes a fundamental statistical analysis of the crack geometry and aggregate size and position relative to the crack [20]. Excellent comparison

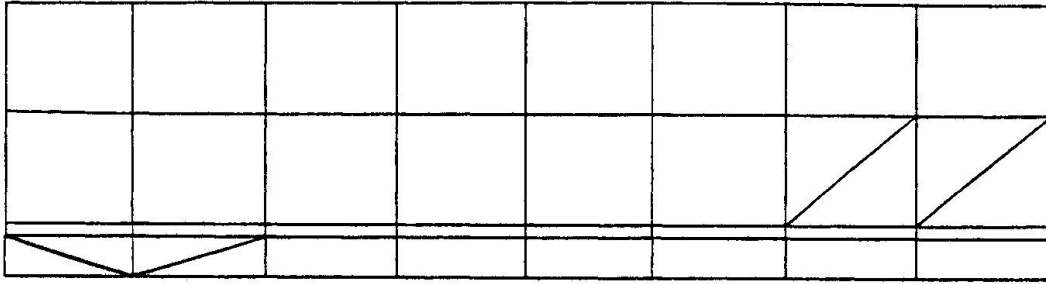

(a) Initial finite element mesh

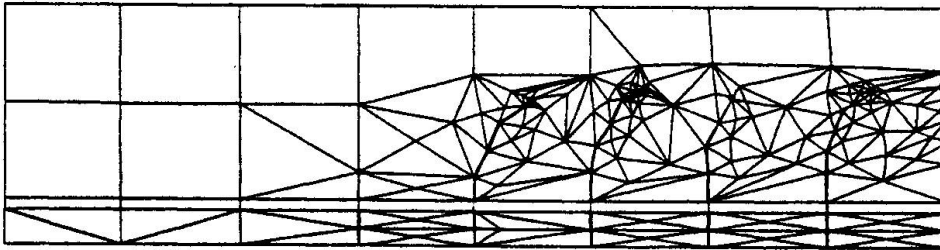

(b) Final mesh configuration

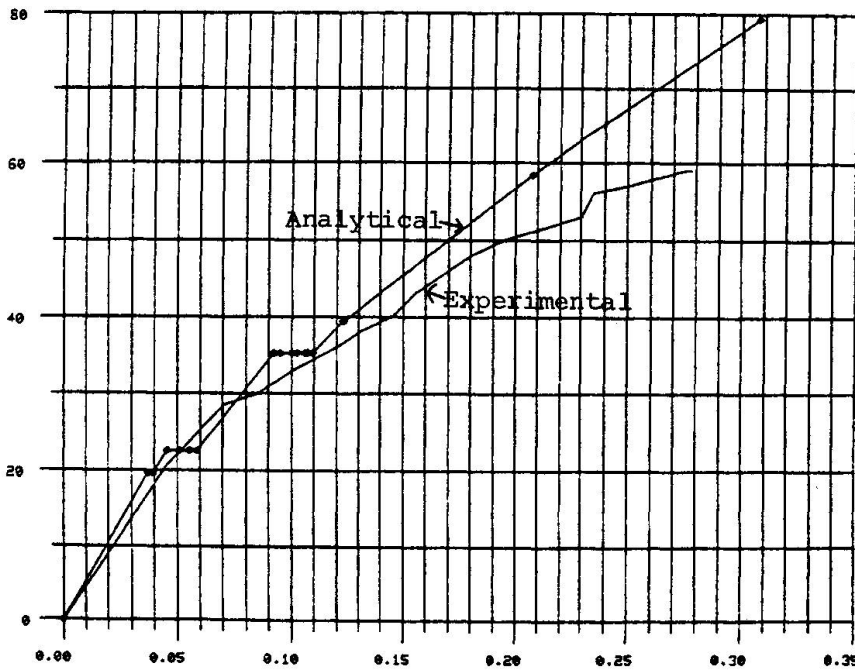

(c) Load-displacement curve

Fig. 4 Reinforced Concrete Beam Analysis Utilizing Fracture Mechanics



was obtained between predicted and measured shear-slip curves for various crack width and concrete strength values and, at least qualitatively, for cyclic loading. A few typical comparisons are shown in Fig. 5. In a parallel study of experimental data for small crack widths, equations were developed for the shear stress and normal stress as a function of the crack width and slip and the agreement with experimental data is very good [21].

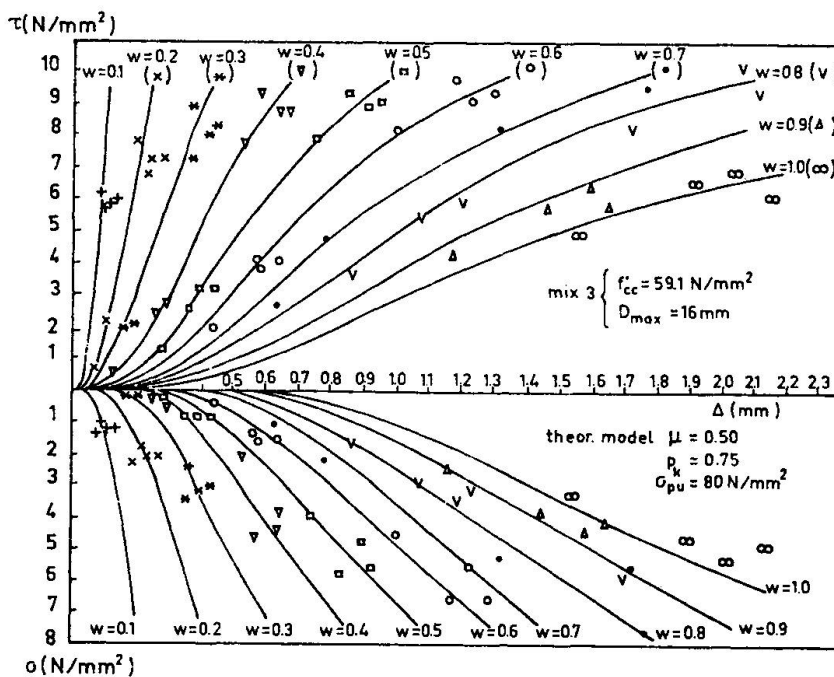

Fig. 5 Comparison Between Experimental Values for a Concrete with $f'_{cc} = 59 \text{ N/mm}^2$ (8428 psi), $D_{\max} = 16 \text{ mm}$ (0.63 inch) and theoretical values, with $p_k = 0.75$, $\mu = 0.50$ and $\sigma_{pu} = 80 \text{ N/mm}^2$ (11428 psi) ($1 \text{ N/mm}^2 = 0.007 \text{ psi}$, $1 \text{ mm} = 0.039 \text{ in.}$)

Other investigations have been concerned with the basic properties, especially the stiffness, of cracked reinforced concrete. In most cases orthogonally reinforced flat elements were subjected to in-plane tensile, compressive, and shear loading [22,23,24]. The material behavior models resulting from these studies are useful in the development of several types of micro and macro models of reinforced concrete.

The dowel effect of reinforcing bars crossing cracks can also be significant and several investigators have studied it. White, Gergely, and Jimenez [52] established idealized hysteresis loops for the two separate mechanisms of IST and dowel action, and then combined them to give a model for the combined mechanisms. The proposed model predicts the effects of cycling reasonably well (Fig. 6), and also predicts the amount of shear carried by each mechanism as a function of bar size and cycling. However, more work needs to be done for various specimen geometries, reinforcement arrangements, and cover. In the meantime the available information should be helpful in advanced analytical investigations, especially in parametric studies.

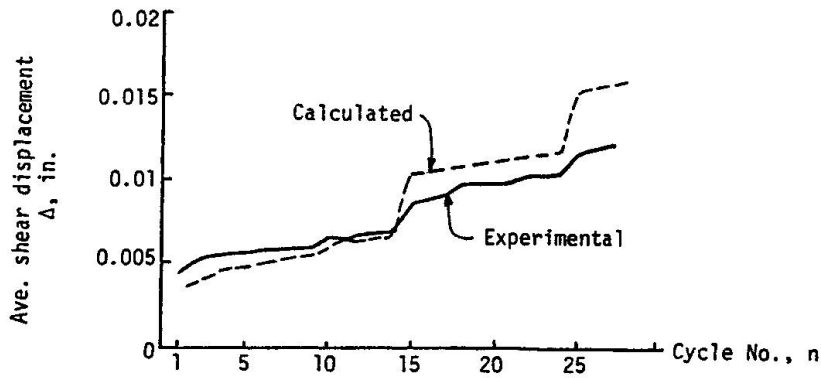

Fig. 6 Increase in Maximum Shear Displacement with Cycling

3. BEAMS, SLABS, AND SHELLS: BEHAVIOR UNDER SHORT-TERM LOADS

Prediction of the response of reinforced concrete beams, slabs, and shells by analytical means can be categorized into short-term and long-term behavior:

a. Short-term loadings:

- (1) ultimate load capacity in flexure
- (2) ultimate load capacity in shear
- (3) displacements at working loads
- (4) complete load-deflection response as load is increased to failure.

b. Long-term loadings:

- (1) time-dependent displacements, accounting for creep, shrinkage, and cracking effects produced by creep and shrinkage
- (2) changes in ultimate load capacity induced by creep and shrinkage (usually negligible).

Items a(1), a(3), and a(4) have received the most attention from analysts, with the latter topic, prediction of short-term load-deflection response, being perhaps the most "popular" problem for FEM analysts. From a design perspective, however, this quantity is of little importance. Instead, items a(1) or a(2), the ultimate load capacity, and b(1), the long-term displacement, are crucial. The latter parameter produces the most problems in actual structures, and item a(2), shear capacity, often controls the thickness of slabs and the types of details used around columns.

It is suggested that we have been overly pre-occupied with short-term flexural response of beams and slabs, and that more of our total research effort should be going into predicting long-term displacements. This topic will be treated in Section 4 of the paper, after we have seen how well the various methods predict short-term strength and stiffness.

3.1 Beams

Several different analytical methods have been developed for the prediction of the response of reinforced concrete linear elements to short-term loads. There are two main types: micro models such as the FEM and the BEM, and macro



models that either utilize entire members as stiffness elements, or that employ various analogies such as the truss analogy or the plastic analysis approach.

Both the micro- and macro-approaches are important because they generally serve different purposes -- the micro models allow a detailed study of stresses and deformations whereas the macro models are more suitable for design purposes. Extensive work is being done currently on both approaches.

Many investigations have focused on the finite element analysis of reinforced concrete beams; they are not reviewed here in detail. They differ mainly in the idealizations and assumptions used: type of bond-slip, cracking criteria and crack representation (smeared or discrete), stress-strain characteristics of concrete, type of element, and shear transfer across cracks. In most cases the comparison with experimental data is good, but this is often due to the fact that the type of member and loading selection for comparison justify the assumptions. For example, the load-deflection diagram of a slender beam is not affected much by bond slip and therefore an analysis using a perfect bond model is satisfactory. This would not be the case for a fixed-ended beam subjected to repeated loading. Clearly what is needed is a parametric study for various types of structures and loading to assess the importance of the various factors and assumptions; this was pointed out in 1967 in the very first paper on the subject [26].

In a paper by Suidan-Schnobrich 1973 [25] which used three-dimensional isoparametric elements, no bond slip, and a constant crack shear stiffness, the agreement with experiments on slender beams is good up to concrete crushing. However, when shear is important, the shape of the nonlinear bond-slip and the use of crack shear transfer stiffness curves is important [27]; a set of load-displacement curves is shown in Fig. 7.

One of the somewhat controversial questions today is the choice of smeared or discrete cracks. In cases where many cracks have formed or the overall behavior of a structure is of interest, the smeared crack approach is convenient and useful. However, if local effects are important the discrete crack analysis can better account for secondary cracks around bars, dowel effects, shear transfer across cracks, and is more suitable for developing an understanding of local behavior. Recent developments in automatic mesh generation and mesh optimization for discrete crack propagation analysis have removed all drawbacks of the approach [10].

As mentioned before, one of the main difficulties in the application of the FEM to the analysis of reinforced concrete structures is that the behavior in most cases strongly depends on the characteristics of elements or factors with

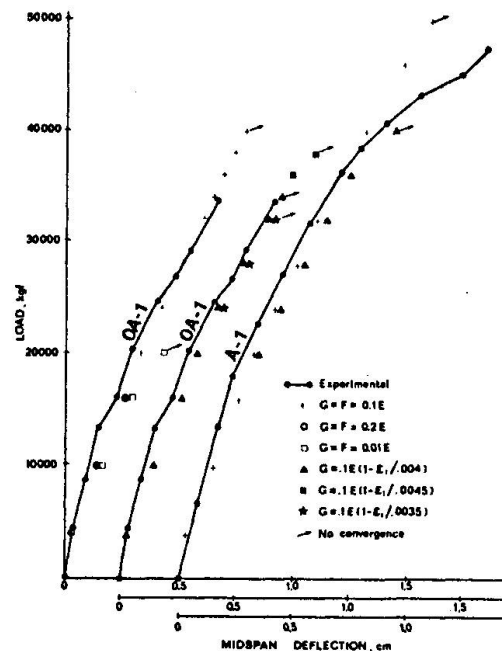

Fig. 7 Load Deflection Curves



variable properties. One approach, mainly for design purposes, is to represent the properties of variable components statistically. In one preliminary study the concrete stress-strain curve, the geometry, and the bond-slip curve were modeled in a stochastic manner by Almasi [28]. It was pointed out that more experimental information is needed about the properties and scatter of the important parameters in the form of histograms.

The FEM method has been used mainly for the analysis of the local behavior of individual structural members. Other analytical approaches have been aimed at predicting the overall response of members; these are more appropriate for design practice. Several extensions of the old truss analogy have been developed for the analysis of beams for the combined effects of shear, torsion, and bending. The best known are the skew bending theory, the variable angle space truss model, the plastic analysis method, and the compression field theory. These theories are based on logical sets of assumptions and use well-known approaches of elasticity or plasticity. Results obtained so far for specific classes of problems have been good, however, empirical correction factors, that are not yet understood sufficiently, are still necessary to account for some effects, such as the properties of concrete under complex stress conditions. Yet, it is likely that useful and rational design methods will evolve from these theories, in fact, several codes already contain such provisions. In addition, and perhaps more importantly, these approaches are highly useful in studying the effects of concrete, transverse steel, and longitudinal steel on the capacity of beams subjected to complex loading.

Good comparisons with experimental results have been obtained in isolated cases but this is partly due to the proper choices of the "effective concrete strength factor." Also, the first three theories mentioned above cannot predict the complete behavior up to failure, only the failure loads. Considerable improvement in the plastic theory and the compression field theory is expected in the next few years.

The variable angle truss analogy is essentially identical to the plastic analysis for the failure condition. Some of the developments were concerned with tension failure and resulted with acceptable methods for bending and shear [29], torsion and bending, and also for all three actions: bending, shear, and torsion [30,31] for underreinforced beams. However, considerable work remains before these approaches become general enough. The case of web crushing failure has been analyzed using the variable truss model and excellent agreement was found with test results [32].

The compression field theory has been used not only to predict the failure load but also to trace the response of beams to combined torsion, flexure, and axial load or shear, flexure and axial load. The agreement between predicted response and experimental results is very good both for nonprestressed and for prestressed members [33,34]. Fig. 8 shows a comparison of predicted and measured torsional capacities of six beams with various amounts of steel for proportional amounts of longitudinal and transverse steel. The approach is applicable for the cases of all steel yielding, only transverse hoops yielding, or concrete crushing without steel yielding.

3.2 Slabs: Load-Deflection Behavior and Flexural Capacity

The finite element method offers the best analytical capability to determine the complete load-displacement behavior of a slab loaded up to a flexure-induced failure. Many comparisons of theory with experiments are available, with the corner-supported, centrally loaded, square reinforced concrete slab tested by McNeice being the most common standard for comparison.



A layered approach has been adopted by most recent investigators. Extensive cracking occurs in nearly all slab structures, leading to the currently accepted conclusion that smeared crack representation is preferred over discrete cracking. Most FEM models show that tension stiffening effects in the uncracked concrete must be accounted for to avoid overestimates of slab displacements over a substantial portion of the higher ranges of loading. Characterization of concrete compressive strength behavior is most often an elasto-plastic idealization with compressive yielding governed by the von Mises criterion, although a nonlinear stress-strain relation with a descending branch is not uncommon.

The treatment of crack initiation and propagation, and of the tension mechanism, are key factors in finite element modeling of flexural behavior of reinforced concrete slabs, although somewhat conflicting findings are reported on the need to model tension stiffening. At least five methods for accounting for tension stiffening effects are reported in the literature; Gilbert and Warner [35] discuss four of the five, including a stepped tensile stress-strain diagram (Scanlon [36], Fig. 9a), a gradual unloading diagram (Lin and Scordelis [37], Fig. 9b), a piece-wise linear diagram with a discontinuity at crack initiation (Fig. 9c), and their own method of modifying the stiffness of the tensile reinforcing steel (Fig. 9d). A fifth method, used in a time-dependent FEM analysis by Marcherta, Fistedis, Bazant, and Belytschko [38], has a gradual, time-dependent reduction of normal tensile stress to zero after a crack forms (Fig. 9e).

Central slab deflections from the McNeice [39] experiment are compared with five analyses conducted by Gilbert and Warner [35] in Fig. 10. The five analyses include the first four tension stiffening mechanisms described above and the case of no tension stiffening. It is apparent that in this particular formulation the tension stiffening mechanism must be included to get satisfactory results of deflection prediction in the post-cracking range. All methods give satisfactory ultimate load capacities.

A comparison of Gilbert's and Warner's results (using the modified steel stiffness) and the FEM results of other investigators is shown in Fig. 11. The major disadvantage of modifying the steel stiffness is the determination of how this modification is to be done; it is a strong function of the proximity of the steel to the crack initiation area.

Another comparison for the same slab is given by Bashur and Darwin [40], who developed a nonlayered FEM model that treats the slab as an incrementally-elastic, anisotropic structure with no tension stiffening. Agreement with the test results is better than that provided by the other models (not including that of Gilbert and Warner). The advantage of the approach by Bashur and Darwin is that cracking is modeled as a continuous process and is not restricted to discrete layers.

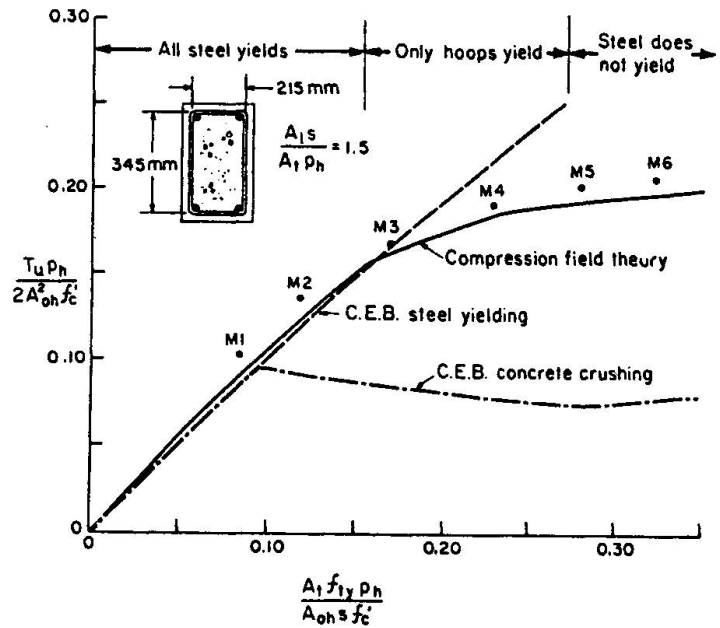
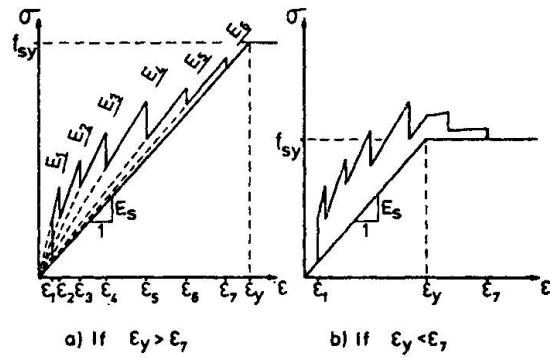
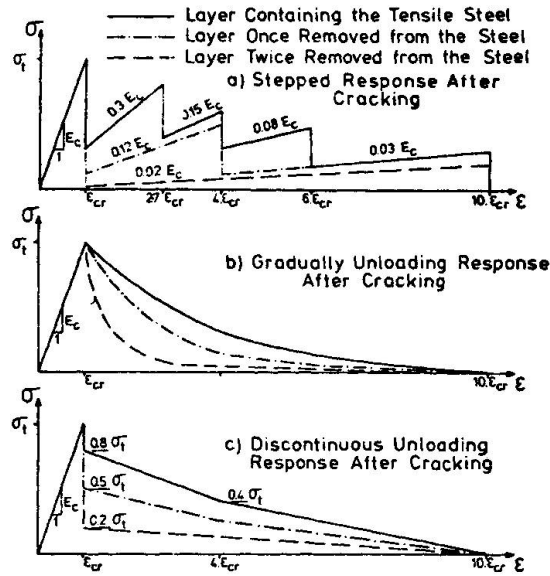

Fig. 8 Torsional Capacity versus Amount of Reinforcement



Material Modelling Law :

ϵ_1	ϵ_2	ϵ_3	ϵ_4	ϵ_5	ϵ_6	ϵ_7
ϵ_{cr}	$1.5 \epsilon_{cr}$	$3 \epsilon_{cr}$	$5 \epsilon_{cr}$	$8 \epsilon_{cr}$	$11 \epsilon_{cr}$	$14 \epsilon_{cr}$

E_1	E_2	E_3	E_4	E_5	E_6
$4.0 E_s$	$2.7 E_s$	$2.0 E_s$	$1.6 E_s$	$1.4 E_s$	$1.05 E_s$

d) Modified Stiffness of Reinforcing

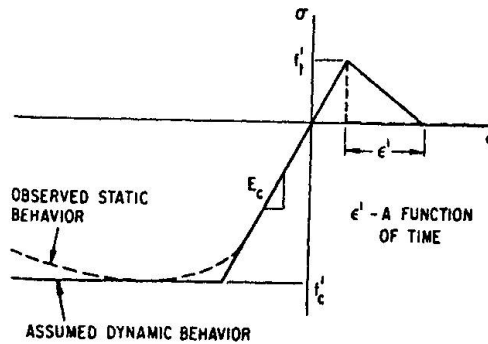

e) Time-Dependent Reduction in Tensile Strength

Fig. 9 Tension Stiffening Models



These comparisons are at the same time both encouraging and contradictory, and indicate that we still have some major points to resolve about the nonlinear analysis of reinforced concrete slabs by the FEM. Perhaps the most important factors are (a) the modeling of the post-cracking tensile stiffness of the concrete, and of shear stiffness, at cracks, and (b) the extent of cracking (total amount of cracking, and depth of crack penetration) in a given section of the slab.

3.3 Shear Punching Action in Reinforced Concrete Slabs

Punching action in slabs, induced by shear forces, exhibits only low levels of ductility. Hence there is relatively little motivation to pursue a refined analysis procedure for the purpose of accurately predicting load-displacement response. On the other hand, strength in punching shear is of paramount importance. The FEM and the plastic analysis method (PAM) are best suited to determining strength. Only the PAM method will be discussed here, although there have been a number of excellent FEM developments directed at predicting the punching shear strength of slab structures. As an example, Abdulrahman [41] provides very good predictions of the punching shear strength of the flat heads of prestressed concrete reactor vessels.

Braestrup [42] has applied a plasticity approach to punching shear strength of reinforced concrete flat slabs loaded with a single circular punch. Assuming that flexural failure is prevented, the failure mechanism for this situation is a solid of revolution being punched out of the slab. Braestrup assumes that the slab flexural reinforcement contributes nothing to the punching shear strength because if the steel was highly stressed (say to yield) then the slab would fail in flexure at a lower load.

In reality, the flexural steel may influence punching shear strength through either dowel action or membrane action. Slab boundary conditions are quite important since they have a strong effect on the deformations of the slab.

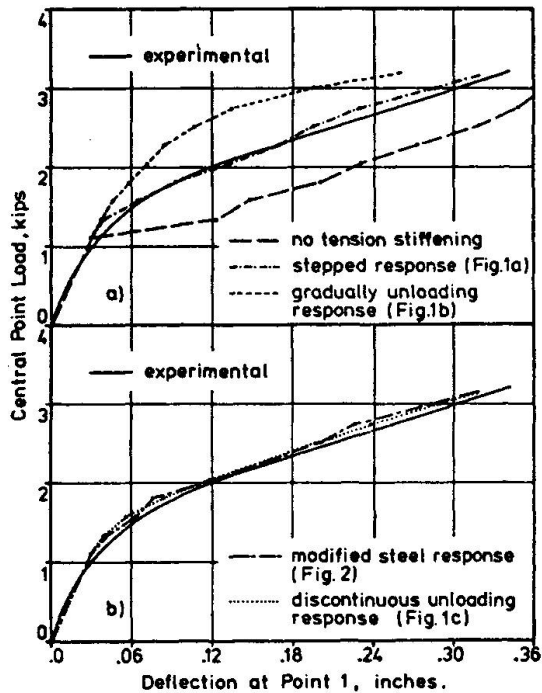

Fig. 10 Load Versus Deflection Curves at Point 1 of McNeice's Slab

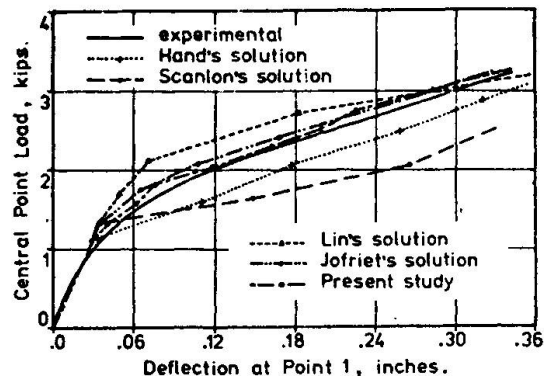

Fig. 11 Load Versus Deflection at Point 1 of McNeice's Slab - Comparison with Previous Studies

The concrete constitutive model includes the assumptions of rigid, perfectly plastic material with a modified Coulomb failure criterion, and with deformations prescribed by the associated flow rule (normality condition). Three properties of the concrete are needed in the analysis: uniaxial compressive strength, uniaxial tensile strength, and angle of internal friction.

Comparison of the PAM theory predictions with the results of punching shear tests by Taylor and Hayes are given in Fig. 12a. Two analytical curves for strength vs. a punch diameter parameter are given for different assumed values of concrete tensile strength: 0 and $f'_c/400$. Pull-out tests on unreinforced slabs (by Hess) are also plotted as triangles. Agreement between theory and test is quite good, with the theory apparently picking up the slight dependence of punching strength on the punch diameter.

In a more general comparison by the same investigators (Nielsen, Braestrup, Jensen, and Bach) [43], the test results of four different investigators are plotted along with theoretical predictions using four values of concrete tensile strength (Fig. 12b). The strength predictions are all on the high side, and a concrete effectiveness factor ν is once again needed to account for the lack of ductility of concrete (ductility is necessary to permit the redistribution of stresses implied in the PAM). Values of ν range from 0.5 to 0.89 for these four test series. The best value of ν was found to be $\nu = 4.22/\sqrt{f'_c}$ where f'_c is in MPa. This value, which is based on 101 tests, has a coefficient of variation of 0.21.

4. TIME-DEPENDENT DEFORMATIONS

Prediction of long-term displacements of reinforced concrete structures is of great importance to the designer and to the owner. Such predictions are severely complicated by our incomplete understanding of creep and shrinkage, and of differences between laboratory specimens and in-place concrete. Several selected examples are presented here where reasonable success has been achieved in predicting displacements under realistic loading conditions for time periods of several years. Significant developments in new creep theories by Z.P. Bazant are summarized by him elsewhere in this symposium volume and are not discussed here.

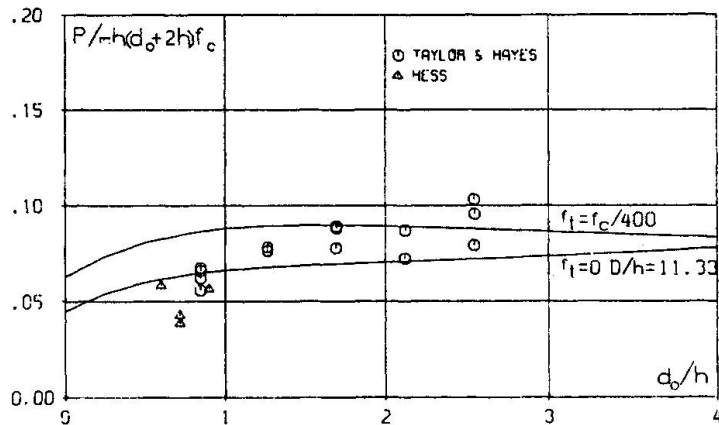

Fig. 12a Load Parameter as Function of Punch Diameter. Tests Compared with Theory.

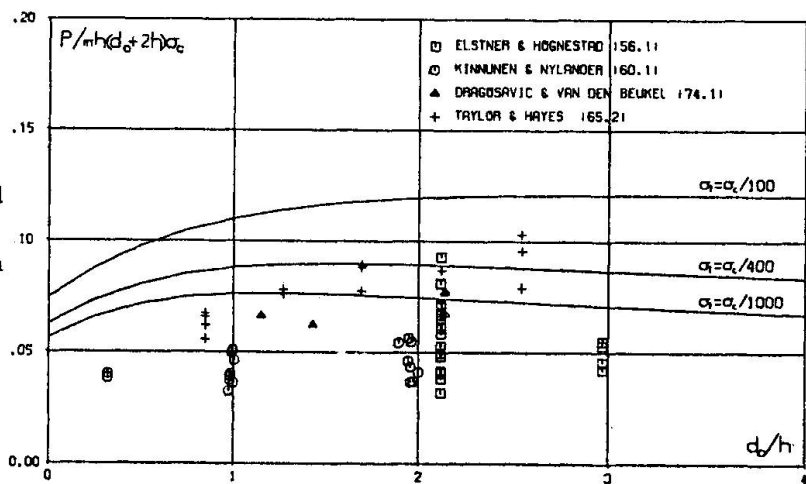

Fig. 12b Results of Punching Tests on Slabs Compared with Theoretical Predictions.



4.1 Beams and Frames

Kang and Scordelis [44] present a finite element analysis procedure that predicts the response of planar prestressed concrete frames to both long-term service loads and short-term loads to failure. A layered finite element model is used to represent concrete and conventional reinforcing steel, and prestressing steel is incorporated directly. The analysis accounts for time dependent effects of creep, shrinkage, aging of concrete, temperature history, and loading history. Relaxation of prestressing is also included.

Concrete creep is incorporated with an age- and temperature-dependent integral formulation based on Boltzmann's superposition principle, with a specific creep function taking the form of a modification of that suggested by Zienkiewicz and Watson [45]. This approach is numerically efficient in that history effects may be accounted for by successively updating a single stress increment rather than storing the entire strain or stress history. Nonlinear creep at high stress levels is also included in the model.

Analytical and experimental results for several 12.2 m span post-tensioned concrete girders loaded for 7 years are given in Fig. 13. The beam I-shaped cross section is divided into 15 concrete layers and three reinforcing steel layers, and 11 nodes are used over the 6.1 m half span of the beam. Standard ACI creep data was used since experimental creep data was not available.

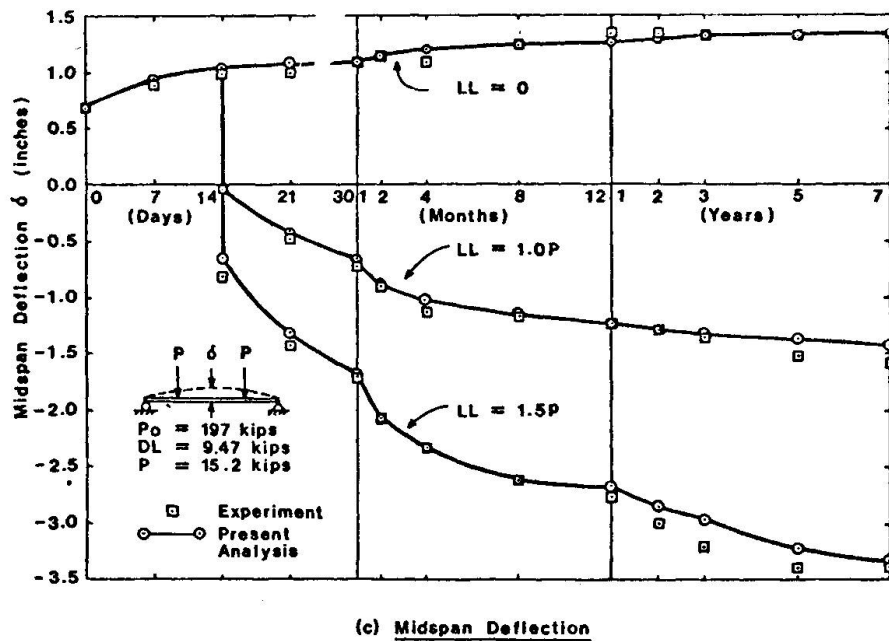
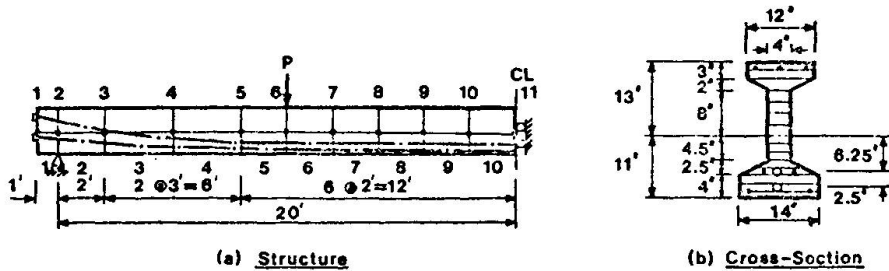

Fig. 13 Breckenridge-Bugg Beam Analysis (1 in. = 25.4 mm; 1 ft = 0.305 m; 1 kip = 4.45 kN).

Comparisons are given for three load histories -- dead load alone, DL plus a central load P of 15.2 kips, and DL plus 1.5 P . Agreement between the experiments and the analytical predictions are excellent. This analysis model appears to be very well-suited for design applications on "monumental" or extremely complex structures where the computer costs may be justified, and for parametric studies to produce better design guidelines and code recommendations relating to long-term displacements and calculation of prestress losses.

4.2 Slabs

The short-term loading analysis of slabs by Gilbert and Warner, as summarized in an earlier section of this paper, has been extended by the same authors [46] to include creep and shrinkage strains. These strains are calculated from a difference formulation of a nonlinear constitutive relation and are then inserted into the analysis through an initial stress incremental relaxation procedure. Three components of concrete creep strain are assumed: a non-recoverable, fully hardening "Dischinger" component; a fully recoverable, non-hardening viscoelastic component; and a component that accounts for nonlinear effects at high load levels. The shrinkage component is assumed to have the same time dependency as does the total creep curve taken at constant stress.

Comparison of predicted displacements with measured results for three locations on an internal panel of a 241 mm thick flat slab structure tested by Taylor [47] are given in Fig. 14a. The sustained load (self-weight of slab) was applied at 56 days and a short-term live loading of half the slab weight was added at 126 days. The agreement between test and analysis is excellent, but this must be tempered by the fact that calculations were based on assumed values of concrete properties rather than on any measured values. Perhaps a more convincing application of the theory is in the comparison given in Fig. 14b, where actual creep data have been used in the computer program to predict the response of three beams with varying amounts of compression steel. These beams were loaded for 2.5 years.

This type of analysis is not feasible in design, at least for most structures, but it can play an important indirect role in design when used in a simulation mode to study the influence of creep effects on different types of structures, as done by Gilbert [48]. His conclusions include: (a) "there exists a complex interaction between tensile creep, shrinkage, and cracking in reinforced concrete slab behaviour" and the tensile creep mechanism in structures with large uncracked regions is a very important factor, (b) "the effect of shrinkage on long-term slab deflections is greatly influenced by the extent and direction of previous cracking", (c) redistribution of bending moments in two-way slabs is strongly dependent upon the magnitude of shrinkage and (d) the concrete tensile strength and tensile creep properties are important factors in service load behavior.

The detailed comparisons presented in the paper of the relative importance of various parameters for different slab geometries and boundary conditions provides considerable insight into slab displacement behavior. Additional simulations are strongly recommended for other types of reinforced concrete structures.

4.3 Shells

Rashid, Ople, and Chang [49] were among the earliest investigators to compare detailed creep analysis results with experiments on complex shell-type structures. Thermal and pressure tests (representing 13 different loading combina-

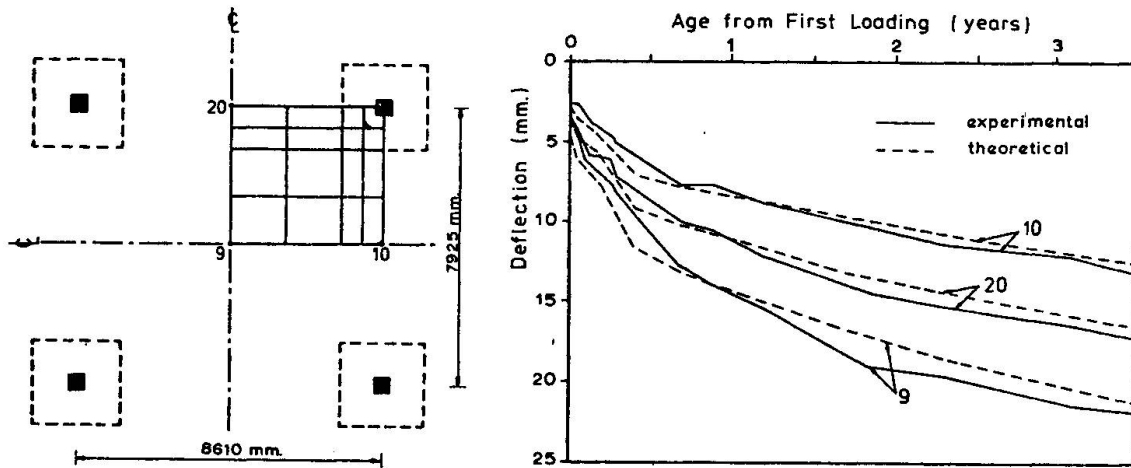

Fig. 14a Typical Internal Panel of Flat Slab Tested by Taylor.

Time-Deflection Curves for Flat Slab Tested by Taylor.

tions) were conducted on a large scale model of a prestressed concrete reactor vessel over a 2.5 year time period. The axisymmetric finite element analysis accounted for: (a) creep under triaxial states of stress and a transient temperature field, (b) tensile cracking of concrete under triaxial stresses, and (c) yielding of liner and reinforcement. Typical comparisons between experimental and theoretical values of circumferential and axial strain are given in Figs. 15a & b.

The creep properties were characterized by a uniaxial creep function which included early creep, temperature-dependency, age-dependency, and coefficients determined from experimental data on concrete specimens.

In retrospect, it appears that creep analysis capabilities for reinforced concrete have not had any "quantum jump" over this early effort by Rashid and his co-workers.

5. NONLINEAR THREE-DIMENSIONAL ANALYSIS

A three-dimensional analysis capability is needed for the refined analysis of many reinforced concrete structures, such as thick shells, non-symmetric pressure vessels, and in determining the punching strength around columns of slab structures. While 3-D elastic analysis is limited only by computer costs, very substantial problems arise in devising a 3-D post-cracking capability for reinforced concrete structures. Two particularly severe difficulties are: (a) proper treatment of concrete cracking, including accounting for the interaction of cracks in different directions as well as finding a proper criterion for crack initiation and extension, and (b) a general accounting for the effect of multiaxial stress states on concrete strength and stiffness.

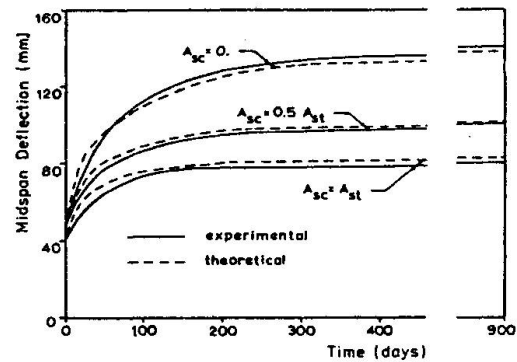

Fig. 14b Time-Deflection Curves for Beams Tested by Washa and Fluck.

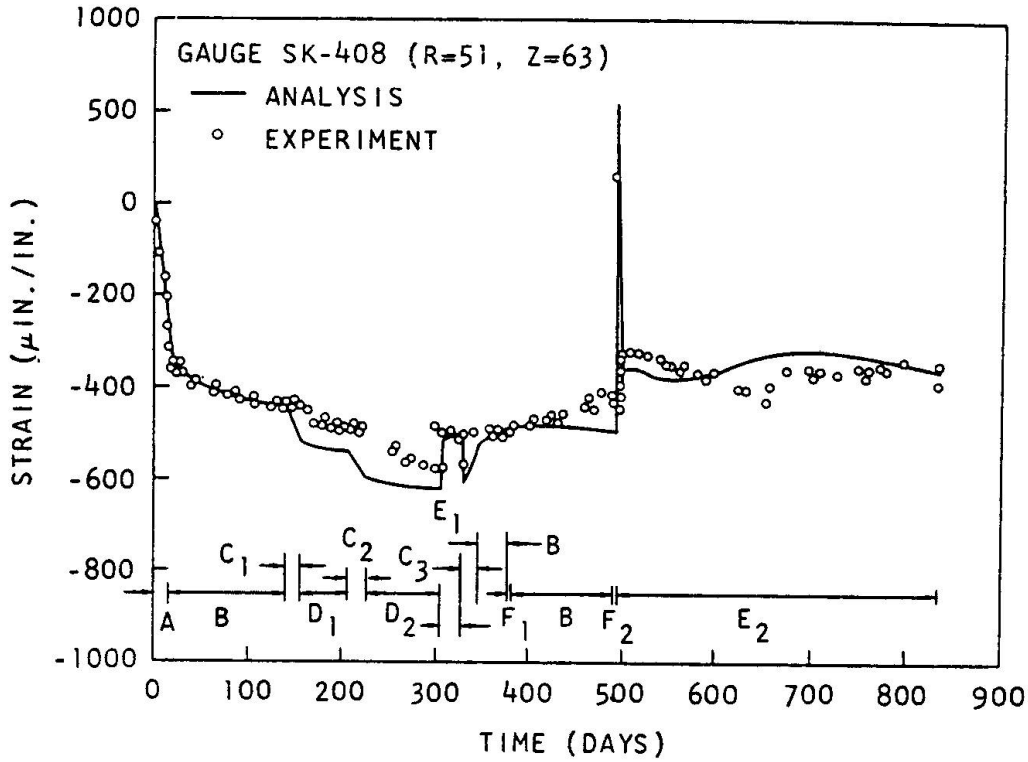

Fig. 15a Axial Concrete Strain at Haunch .

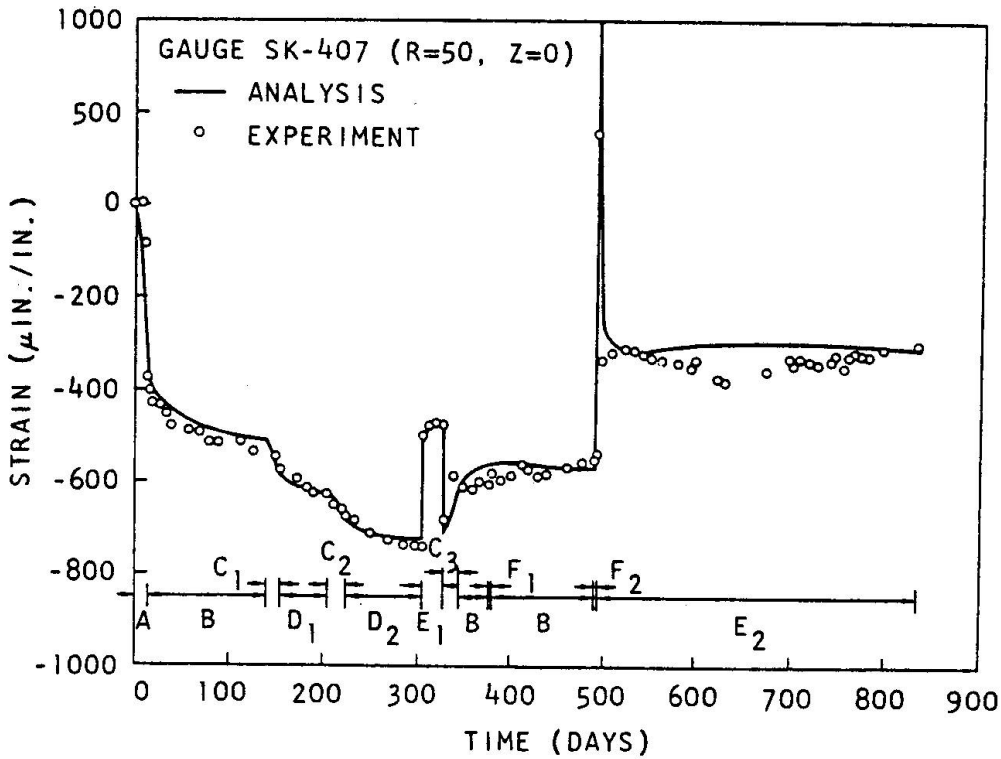

Fig. 15b Circumferential Concrete Strain at Inner Midplane.



Only one of many 3-D codes in existence will be illustrated here. Bathe and Ramaswamy [50] apply a 3-D finite element analysis capability (ADINA) to the analysis of internal pressurization of a prestressed concrete reactor pressure vessel model, and to other problems. The formulation accounts for nonlinear behavior of concrete under biaxial and triaxial stress conditions, with failure surface representations of both tensile cracking and compressive crushing. Strain-softening effects are also included.

Comparison of analysis with the results of a pressure vessel experiment is shown in Fig. 16 where analysis results are plotted for two values of uniaxial concrete strength -- 500 psi (splitting test results) and 615 psi (corresponding to the measured ultimate tensile strain). Predicted radial and circumferential cracking with increasing pressure is also shown. Agreement is quite good up to about 600 psi, but at higher pressures the analytical model does not retain adequate stiffness, thus indicating that the cracking process in the actual structure occurs more gradually than that modelled in the analysis.

The slab structure of Jofriet and McNeice [39] was also analyzed by Bathe and Ramaswamy, using nine 16-node isoparametric elements with 3x3x3 integration and twenty-four 3-node truss elements to idealize 1/4 of the slab. Comparison of predicted and actual displacements at four locations on the slab is given in Fig. 17 ; the results agree quite well over the entire range of comparison.

There are many areas of application for fully nonlinear 3-D codes in "localized" analysis of reinforced concrete structures. Perhaps one of the simplest examples is the analysis of behavior of a cylindrical specimen with a concentric reinforcing bar under cyclic tension, where the bond mechanism is under study. After the initiation of axial cracking the axisymmetric analysis is no longer valid. With continuing reductions in the computer time and costs associated with nonlinear 3-D analysis, we can expect to see more and more use of such codes in research and special design applications.

6. THE BOUNDARY ELEMENT METHOD (BEM)

The boundary element method (BEM) gained considerable attention during the late 1970's as a powerful analysis technique in continuum mechanics [54]. It affords an attractive alternative to the finite element method (FEM) and the finite difference method (FDM) for certain classes of problems such as two- and three-dimensional elasticity problems, fluid flow, soil mechanics, and stress concentration and crack propagation analyses. Since direct unknown quantities are restricted to the boundaries, the BEM is particularly powerful when relatively large regions of the structure are lightly stressed and hence remain linear elastic (Brebbia and Nakaguma). In many cases where the BEM was compared directly with the FEM, it proved to be more accurate and also to require less input data and shorter computation times.

Since developments in the BEM technique have focussed mainly on elastic analysis, there is little published information on the application of the BEM to reinforced concrete analysis. However, the BEM may well prove to be the optimal method for linear elastic analysis of concrete structures, especially for three-dimensional problems, stress concentration effects, and for plain concrete structures such as dams. It also has considerable potential for the analysis of structures where moving boundaries are involved, such as for crack analysis. Sliding or any type of force transfer at boundaries, such as at cracks or at steel-concrete interfaces, can be treated by this method.

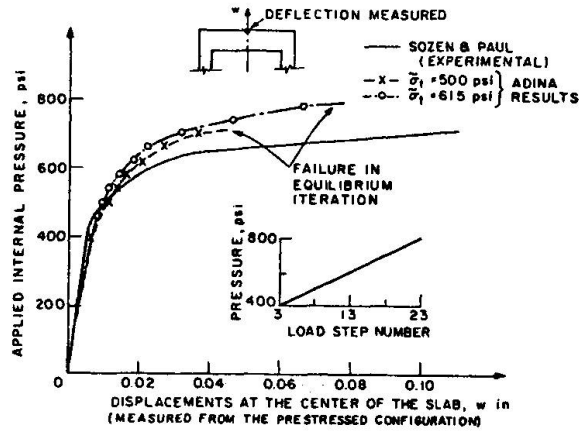

a. Displacements of the slab at mid-span

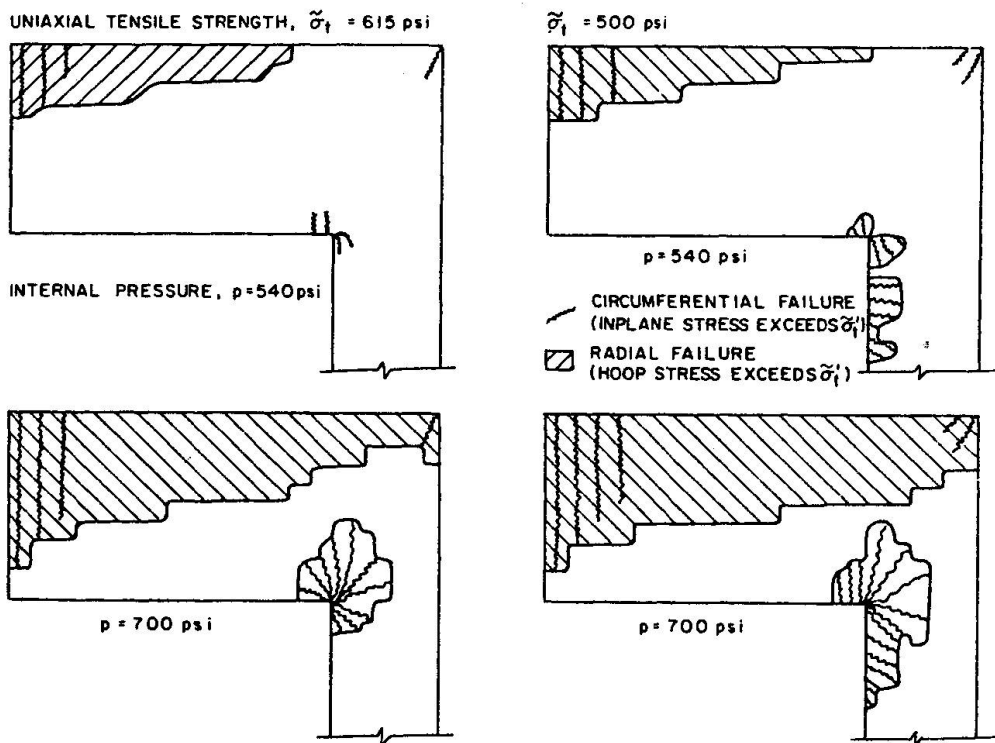

b. Zones of tensile failure of the reactor vessel

Fig. 16 3-D Pressure Vessel Analysis

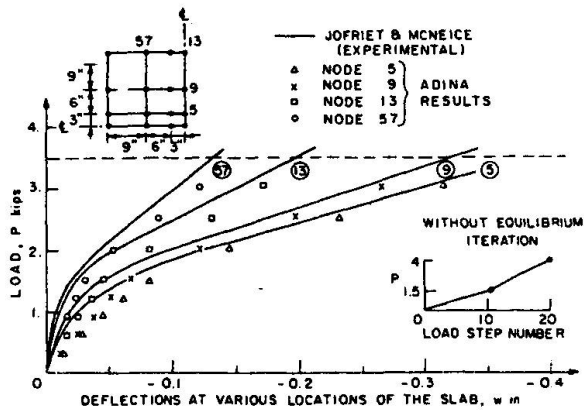

Fig. 17 Vertical Deflections of the Corner-Supported Concrete Slab



The BEM is not yet efficient for general nonlinear analysis. However, recent developments have indicated that a combination of the FEM and BEM approaches could provide an attractive and probably exceptionally powerful method for many types of complex problems in reinforced concrete analysis. The BEM provides a fertile and promising area of research [55].

CONCLUDING REMARKS

Four major types of methods have been used extensively in the analysis of reinforced concrete. The finite element method is currently the most popular and its development has reached a mature stage. The boundary element method is relatively novel and shows great potential for the analysis of many types of structures, including reinforced concrete. The finite difference method has limited versatility in comparison with the other methods and therefore has a relatively minor role in structural analysis. These three methods are used mainly in the detailed analysis of members or regions. Various types of macro models for the idealization of the behavior of members, such as the plastic analysis or diagonal compression theory, are being developed for practical analysis and design purposes. All of these advanced analytical methods need further more detailed empirical information on the local behavior of reinforced concrete which must be supplied by continuing experimental investigations.

REFERENCES

1. Mahin, S.A., and Bertero, V.V. "Prediction of Nonlinear Seismic Building Behavior," J. of the Technical Councils of ASCE, Vol. 104, No. TC1, p. 21, November 1978.
2. Bresler, B., and Bertero, V., "Behavior of Reinforced Concrete under Repeated Load," J. of Structural Division, ASCE, V. 94, No. ST6, June 1968, p. 1567.
3. Lutz, L.A., and Gergely, P., "Mechanics of Bond and Slip of Deformed Bars in Concrete," ACI Journal, V. 64, No. 11, November 1967, p. 711.
4. Nilson, A.H., "Internal Measurement of Bond Slip," ACI Journal, V. 69, No. 7, July 1972, p. 439.
5. Houde, J., "Study of Force-Displacement Relationships for the Finite Element Analysis of Reinforced Concrete," Structural Concrete Series No. 73-2, Dept. of Civil Engineering, 1973.
6. Morita, S., and Kaku, T., "Local Bond Stress-Slip Relationship and Repeated Loading," IABSE Symposium, Resistance and Ultimate Deformability of Structures Acted on by Well Defined Repeated Loads, Lisboa, 1973.
7. Gijbers, F.B.J., de Groot, A.K., and Kusters, G.M.A., "A Numerical Model for Bond-Slip Problems," IASS, Darmstadt, p. 37, 1978.
8. Hassan, F.M., and Hawkins, N.M., "Effects of Post-Yield Loading Reversals on Bond between Reinforcing Bars and Concrete," Rep. SM73-2, Dept. of Civil Engrg., University of Washington, Seattle, 1973.
9. Viwathanatepa, S., Popov, E.P., and Bertero, V.V., "Effects of Generalized Loadings on Bond of Reinforcing Bars Embedded in Confined Concrete Blocks," Report No. UCB/EERC-79/22, University of California, Berkeley, August 1979.

10. Saouma, V., "Automated Nonlinear Finite Element Analysis of Reinforced Concrete: A Fracture Mechanics Approach," Ph.D. Thesis presented to Cornell University, Ithaca, N.Y., 1980.
11. Labib, F., and Edwards, A.D., "An Analytical Investigation of Cracking in Concentric and Eccentric Reinforced Concrete Tension Members," Proc. Instn. Civil Engineers, Part 2, V. 65, p. 53, March 1978.
12. Eligehausen, R., "Ubergreifungsstosse zugbeanspruchter Rippenstabe mit geraden Stabenden," Deutscher Ausschuss fur Stahlbeton, Heft 301, Berlin, 1979.
13. Tepfers, R., "A Theory of Bond Applied to Overlapped Tensile Reinforcement Splices for Deformed Bars," Publ. 73:2, Division of Concrete Structures, Chalmers University of Technology, 1973.
14. A.D. Tocci, "Designed of Lapped Splices in Beams for High-Level Reversed Cyclic Loading," Ph.D. Dissertation, Dept. of Structural Engineering, Cornell University, 1980.
15. Hess, U., "The Anchorage Strength of Reinforcement Bars at Supports," IABSE Colloquium, Plasticity in Reinforced Concrete, Copenhagen, p. 309, 1979.
16. Barsoum, R.S., "Triangular Quarter Point Elements as Elastic and Perfectly-Plastic Crack Tip Elements," Int. J. Numerical Methods in Engineering, V. 11, No. 1, 1977, p. 85.
17. Ngo, D., "A Network-Topological Approach for the Finite Element Analysis of Progressive Crack Growth in Concrete Members," Ph.D. Dissertation, Division of Structural Engineering and Structural Mechanics, U. of Cal., Berkeley, UC-SESM 75-6, 1975.
18. Argyris, J.H., Faust, G., and Willam, K.J., "Finite Element Analysis of Concrete Cracking," ISD Report No. 254, Stuttgart, 1979.
19. Bazant, Z.P., and Cedolin, L., "Blunt Crack Band Propagation in Finite Element Analysis," J. of the Engineering Mechanics Division, ASCE, V. 105, No. EM2, 1979, p. 297.
20. Walraven, J.C., "Experiments on Shear Transfer in Cracks in Concrete," Part II: Analysis of Results, Report 5-79-10, Stevin Laboratory, Delft University of Technology, 1979.
21. Walraven, J.C., Vos, E., and Reinhardt, H.W., "Experiments on Shear Transfer in Cracks in Concrete," Part I: Description of Results, Report 5-79-3, Stevin Laboratory, Delft University of Technology, 1979.
22. Geistefeldt, H., "Stahlbetonscheiben im gerissenen Zustand - Berechnung mit Berucksichtigung der rissabhangigen Schubsteifigkeit im Materialgesetz," Bericht Nr. 76-19, Technischen Universitat Braunschweig, 1976.
23. Collins, M.P., "Investigating the Stress-Strain Characteristics of Diagonally Cracked Concrete," IABSE Colloquium, Plasticity in Reinforced Concrete, Final Report, Copenhagen, 1979.



24. Perdikaris, P.C., White, R.N., and Gergely, P., "Strength and Stiffness of Tensioned Reinforced Concrete Panels Subjected to Membrane Shear; Part I. Specimens with Two-Way Reinforcing," Prepared for the U.S. Nuclear Regulatory Division, Dept. of Structural Engineering, Cornell University, July 1980.
25. Suidan, M. and Schnobrich, W.C., "Finite Element Analysis of Reinforced Concrete," J. Structural Division, ASCE, Vol. 99, ST10, October 1973.
26. Ngo, D., and Scordelis, A.C., "Finite Element Analysis of Reinforced Concrete Beams," J. ACI, Vol. 64, No. 3, p. 152, March 1967.
27. Cedolin, L. and Dei Poli, S., "Finite Element Studies of Shear-Critical R/C Beams," J. of Engineering Mechanics Div., ASCE, Vol. 103, EM3, p. 395, June 1977.
28. Almasi, J., "The Feasibility of using Statistical Theory in the Finite Element Analysis of Reinforced Concrete Beams," (in Hungarian), Melyepitestudományi Szemle, Vol. 25, No. 8, p. 350, 1975.
29. Grob, J. and Thurlimann, B., "Ultimate Strength and Design of Reinforced Concrete Beams under Bending and Shear," Proc. IABSE, 36-II, p. 105, 1976.
30. Muller, P., "Failure Mechanisms for Reinforced Concrete Beams in Torsion and Bending," Proc. IABSE, 36-II, p. 147, 1976.
31. Thurlimann, B., "Plastic Analysis of Reinforced Concrete Beams," IABSE Colloquium, Plasticity in Reinforced Concrete, Introductory Report, Copenhagen, 1979.
32. Nielsen, M.P., Braestrup, and Bach, F., "Rational Analysis of Shear in Reinforced Concrete Beams," IABSE Proc. P-15/78, May 1978.
33. Collins, M.P., "Reinforced Concrete Members in Torsion and Shear," IABSE Colloquium, Plasticity in Reinforced Concrete, Final Report, Copenhagen, 1979.
34. Collins, M.P., "Toward a Rational Theory for RC Members in Shear," J. of Structural Div., V. 104, No. ST4, p. 649, April 1978.
35. Gilbert, R.I., and Warner, R.F., "Tension Stiffening in Reinforced Concrete Slabs," J. of the Structural Division, ASCE, V. 104, No. ST12, Dec. 1978, p. 1885.
36. Scanlon, A., "Time Dependent Deflections of Reinforced Concrete Slabs, Ph.D. thesis, U. of Alberta, 1971.
37. Lin, C.S. and Scordelis, A.C., "Nonlinear Analysis of Reinforced Concrete Shells of General Form, J. of the Structural Division, ASCE, V. 101, No. ST3, Mar. 1975, p. 523.
38. Marcerta, A.H., Fistedis, S.H., Bazant, Z.P., and Belytschko, T.B., "Analysis and Application of Prestressed Concrete Reactor Vessels for LMFBR Containment", Nuclear Engineering and Design, 49(1978), p. 155.
39. Jofriet, J.C. and McNeice, G.M., "Finite Element Analysis of Reinforced Concrete Slabs, J. of the Structural Division, ASCE, Vol. 97, No. ST3, Mar. 1974, p. 631.

40. Bashur, F.K. and Darwin, D., "Nonlinear Model for Reinforced Concrete Slabs," J. of the Structural Division, ASCE, Vol. 104, No. ST1, Jan. 1978, p. 157.
41. Abdulharman, H.O., "Nonlinear Analysis of End Slabs of Prestressed Concrete Reactor Vessels," Ph.D. Thesis, University of Illinois, 1978.
42. Braestrup, M.W., "Punching Shear in Concrete Slabs," Introductory Report of IABSE Colloquium on Plasticity in Reinforced Concrete, Copenhagen, 1979, p. 115.
43. Nielsen, M.P., Braestrup, M.W., Jensen, B.C., and Bach, F., Concrete Plasticity (Beam Shear - Shear in Joints - Punching Shear), Special Publication, Dansk Selskab for Bygningsstatik, October 1978.
44. Kang, Y-J., and Scordelis, A.C., "Nonlinear Analysis of Prestressed Concrete Frames," J. of Structural Division, ASCE, V. 106, No. ST2, Feb. 1980, p. 445.
45. Zienkiewicz, O.C. and Watson, M., "Some Creep Effects in Stress Analysis with Particular Reference to Concrete Pressure Vessels," Nuclear Engineering and Design, No. 4, 1966, p.
46. Gilbert, R.I. and Warner, R.F., "Time-Dependent Behaviour of Reinforced Concrete Slabs," IABSE Proc. P-12/78, 12 pp.
47. Taylor, P.J., "The Initial and Long-Term Deflections of Reinforced Concrete Flat Slabs and Plates," M.E. Thesis, University of New South Wales, Kensington, Australia, 1971.
48. Gilbert, R.I., "Computer Experiments with Reinforced Concrete Slabs," UNICIV Rpt. No. R-195, Univ. of New South Wales, Kensington, Australia, March 1980.
49. Rashid, Y.R., Ople, F.S., and Chang, T.Y., "Comparison of Experimental Results with Response Analysis for a Model of a Pressure Vessel," Proc. International Conference on Model Techniques, British Nuclear Society, July 1969.
50. Bathe, K.J. and Ramaswamy, S., "On Three-Dimensional Nonlinear Analysis of Concrete Structures," Nuclear Engineering and Design, 52(1979), p. 385.
51. Moder, M., "A Fracture Mechanics Approach to Failure Analysis of Concrete Materials," Report TVBM-1001, Lund, Sweden, 1979.
52. White, R.N., Gergely, P., and Jimenez, R., "Shear Transfer in Cracked Reinforced Concrete," Preprint 80-115, ASCE Convention, Portland, April 1980.
53. Nilson, A.H., "Nonlinear Analysis of Reinforced Concrete by the Finite Element Method," ACI Journal, V. 65, No. 9, p. 757, September 1968.
54. Brebbia, C.A. and Nakaguma, R., "Boundary Elements in Stress Analysis," Journal Eng. Mech. Div., ASCE, Vol. 105, No. EM 1, p. 55, 1979.
55. Brebbia, C.A. (editor), "Recent Advances in Boundary Element Methods," Pentech Press, London, 1977.

Leere Seite
Blank page
Page vide



Application and Experimental Verification of Advanced Mechanics in Reinforced Concrete

Exemples d'application et vérification par expérimentation des nouvelles méthodes utilisées en mécanique des structures en béton armé

Anwendungsbeispiele und experimentelle Bestätigung neuer Verfahren im Stahlbeton

JOSEF EIBL

Professor Dr.-Ing.

University of Dortmund

Dortmund, Fed. Rep. of Germany

SUMMARY

By more or less arbitrarily chosen examples of applications and their experimental verification it is attempted to show the significance of these advanced numerical methods for reinforced concrete structures. Still existing restrictions as well as very promising possibilities in new fields of applications are indicated.

RESUME

Des exemples d'application et leur vérification par expérimentation illustrent l'importance de nouvelles méthodes utilisées en mécanique des structures en béton armé. Les réserves encore à faire ainsi que quelques champs d'application spéciaux et prometteurs pour l'avenir sont indiqués.

ZUSAMMENFASSUNG

Anhand willkürlich ausgewählter Anwendungsbeispiele und deren experimenteller Bestätigung wird versucht, die Bedeutung dieser neuen Verfahren für Stahlbetonkonstruktionen zu veranschaulichen. Noch bestehende Einschränkungen und einige spezielle, vielversprechende Anwendungsgebiete in der Zukunft sollen aufgezeigt werden.



1. INTRODUCTION

The behaviour of one-, two and threedimensional reinforced concrete structures under load or imposed deformations is governed by highly nonlinear differential equations, which in general cannot be treated by analytical methods. Therefore at a time where electronic computers had not been available approximations based on the theory of linear elasticity had been used for the predictions of structural behaviour in design work as well as for research purposes.

While in case of one- or twodimensional bending members these methods proved rather satisfactory in other cases as e.g. ultimate limit states or stability problems they gave poor or improper results.

Now during the last 15 years in close connection with the growth of digital computers new powerful numerical procedures have been elaborated, which allow to treat cracked concrete structures in a more realistic manner, provided that nonlinearities resulting mainly from compatibility and constitutive equations of reinforced concrete are available. Intensive experimental research has been undertaken to create this basis.

By these means new results have been gained already, while the full effectiveness of these methods - a generation of faster digital computers has been announced - probably will be proved in future.

A broad range of possible applications for these advanced numerical procedures exists.

2. FIELDS OF APPLICATIONS

Let me begin with an example of practical experience which demonstrates the need for such methods as well as the difficulties still involved in its application:

In an office building (fig. 1) one bearing floor, which was to carry secondary floors by tensile members resp. columns, should be clamped to four towers. The whole dead- and liveload of this 137 m high building were to be transferred by four joints which consisted of an outer prestressed ring, a layer of plain concrete or mortar and the inner tower wall. There is no doubt, that from a structural point of view it seemed justified to investigate this most important detail extensively.

As the load carrying capacity depended highly on the stiffness of the mortar layer, the prestressed outer ring, and the deformation of the rather thin inner ring - conditions which could not be changed - the assumption of elastic behaviour was unsuited and could be dangerous. So it was decided to try an investigation, taking the realistic behaviour of cracked concrete into account.

In 1976 it took several month to find someone who was willing to overtake these task within the given time limit of a few month. The costs were extremely high. At last after some trials because of the problems which arose from organizing tedious calculations over great distances, from misunderstanding and communication difficulties between participants the design was rejected. Only due to a general scientific interest of the contractor the most significant computations could be finished later on [1, 2].

The gained experience may be generalized as follows. These new methods demand a high standard of theoretical knowledge as well as a sound know-how concerning constitutive relations and the experimental behaviour of steel and concrete, if the gained results are to reward the invested amount of work. Important decisions, which are still necessary to solve practical problems, such as e.g.

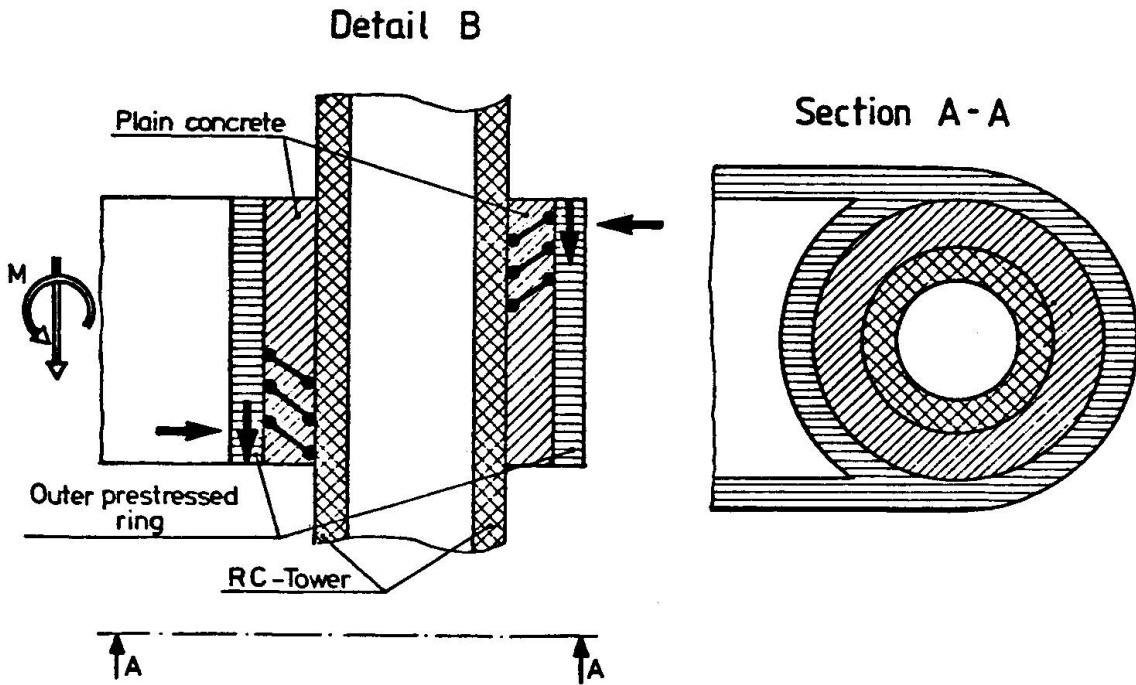
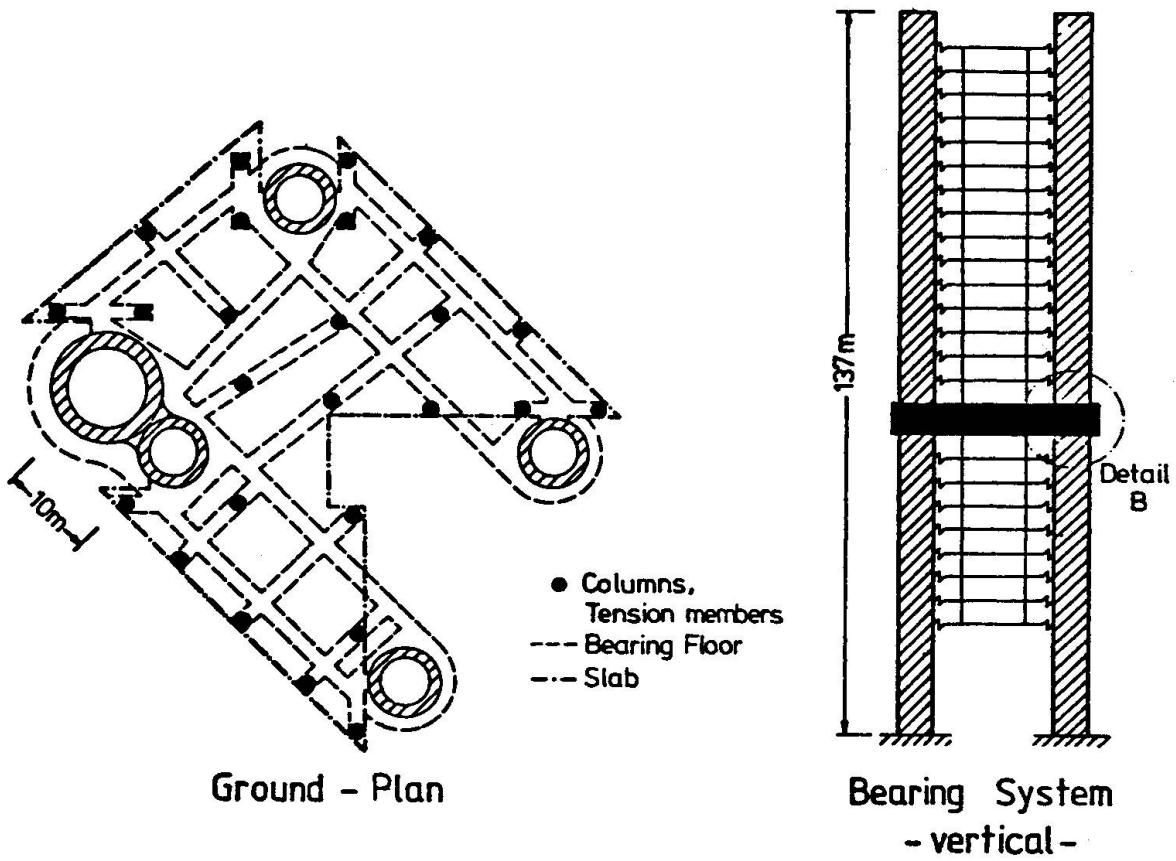

Fig. 1 (according to [2])



the discretisation of the structure, the modelling of the tension behaviour between cracks, the incorporation of the bond characteristics or the use of three- resp. twodimensional models, can only be made by experienced engineers who in many cases are not very familiar with highly sophisticated numerical methods. From here problems for practical use arise. As long as the following difficulties

- communication problems in modelling the structure
- the amount of time for communication, computation and
- the resulting costs

are not overcome, application in design work will be hindered to a great extent.

So to the author's opinion for the near future the application of these special methods in practice is restricted to rare cases, where the necessary amount of time and money will be repaid by the structure. In all other cases available numerical procedures based on the linear theory of elasticity will suffice to solve even rather complicated systems.

Making these more advanced methods applicable for design calculations also further simplifications within the method are necessary. Possible aims of appropriate studies could be

- to determine the limits where complicated biaxial concrete behaviour in case of slabs with low percentage of reinforcement could be avoided [3]
- the evaluation of cases where bond in greater detail may be neglected
- an appropriate modelling of tension-stiffening corresponding to the exactness of practical needs
- the consideration of the scatter of test results when methods are refined just to reach a better data-fit at one single and arbitrarily chosen experimental example.

The Comité Euro-International du Béton (CEB) decided to make its contribution by publishing agreed constitutive laws, so that engineers not so familiar with specific problems may find a basis for their work.

Nevertheless the main field of application will be in research. There these newly developed methods will show their full effectiveness, but only, if they are extensively applied in connection with tests. That means that in all possible cases systematic parameter variations have to be done by simulated experimental investigations. The fact that practical oriented engineers very often do not yet appreciate these new methods stems from their experience that in many cases computer programs have been written, tested at a simple and often used test-example, published and never used.

Accompanying experiments for calibration which are still necessary to the author's opinion may be omitted one day, when sufficient knowledge of material parameters entering computations have been gained. The fact that a priori known experimental results, especially load-deformation relations can be described after the experiment has taken place, should not be overestimated. Everybody doing such calculations knows how many parameter changes are possible and sometimes done to gain such a data-fit.

In research the already mentioned hindrances as communication problems or the necessary amount of time are of secondary importance and may be overcome much more easily.

Admitting all these still valid restrictions frankly does not mean to reject this powerful tool, which is only at its beginning, as will be carried out in the following chapter.

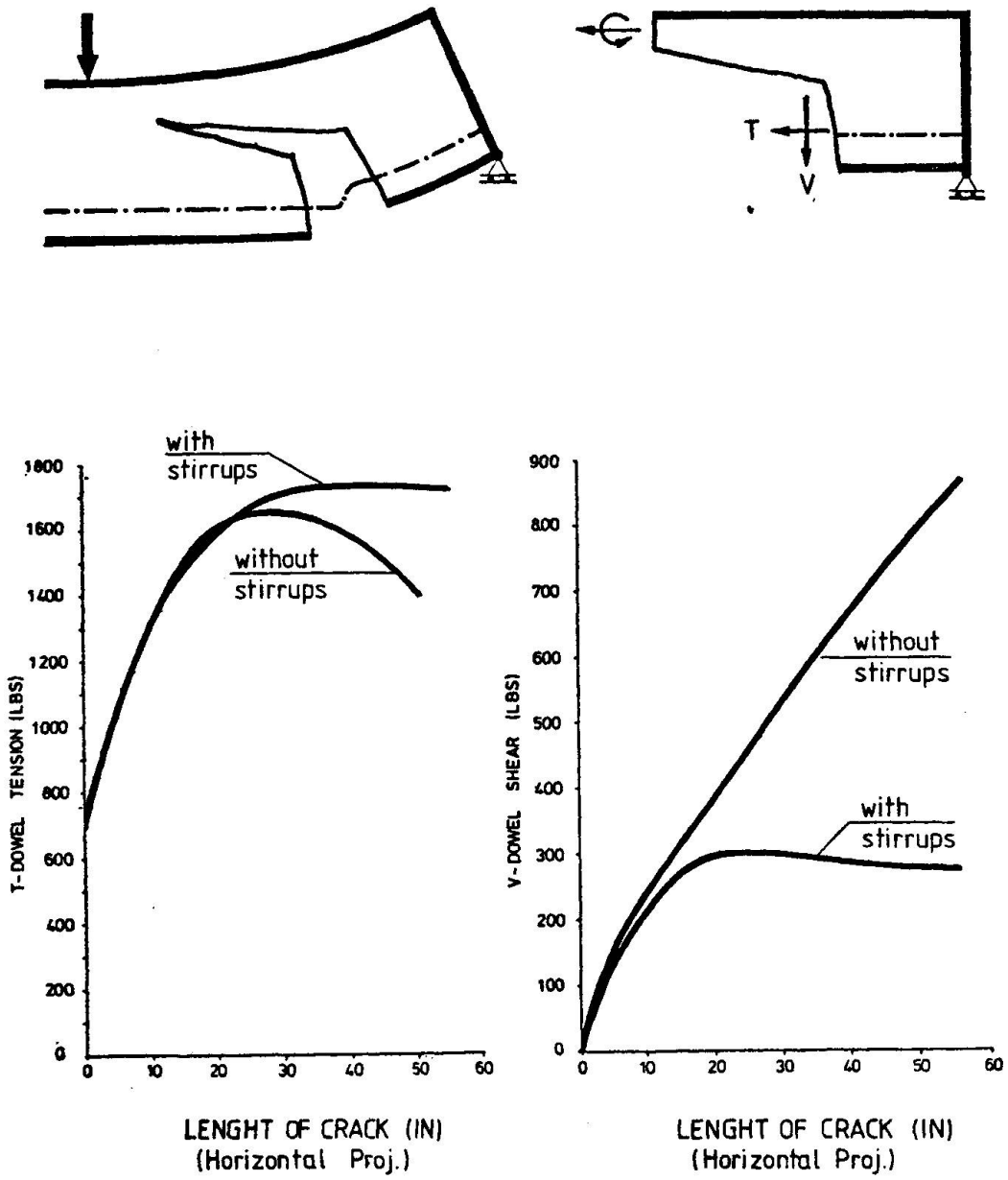

Fig. 2 Investigation of Shear- BEAMS [4]

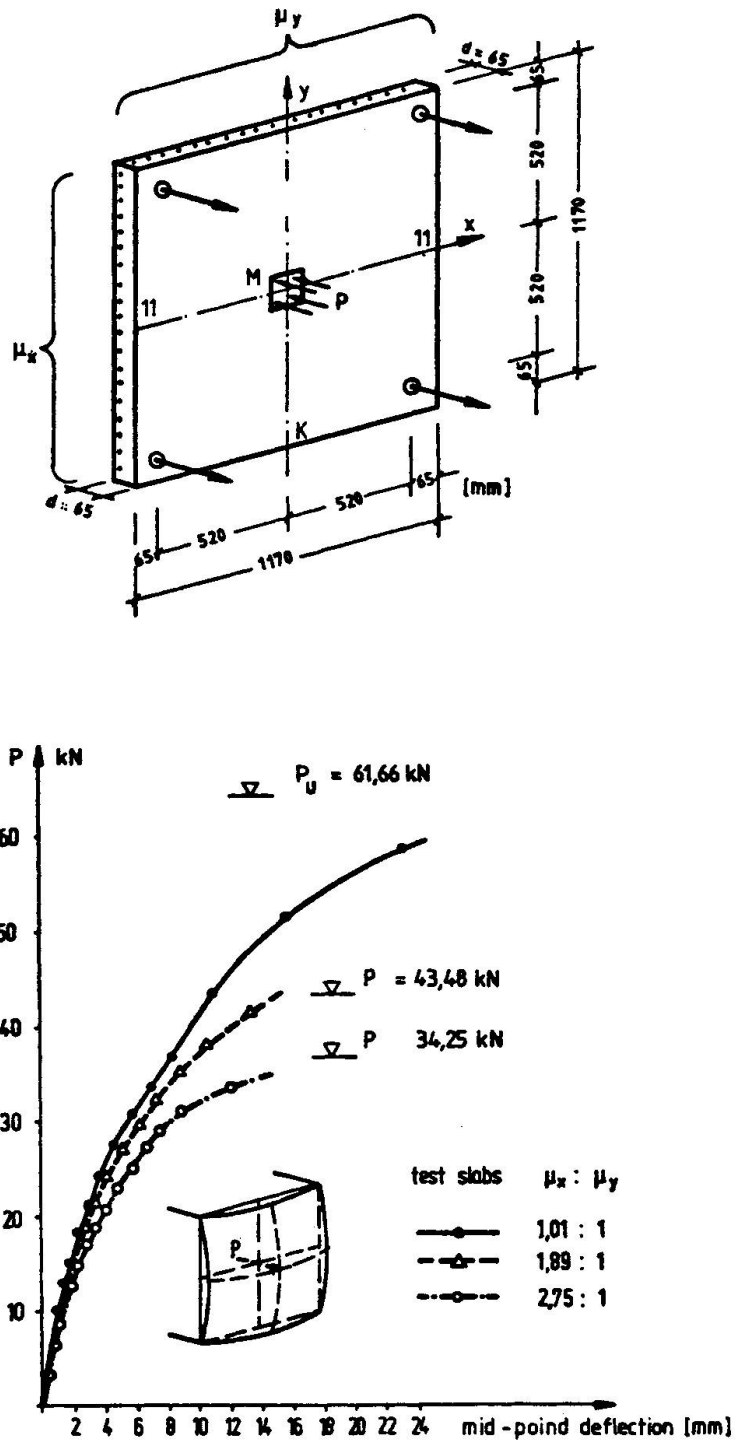

Fig. 3 Deflection Curves- Slab Tests [19]

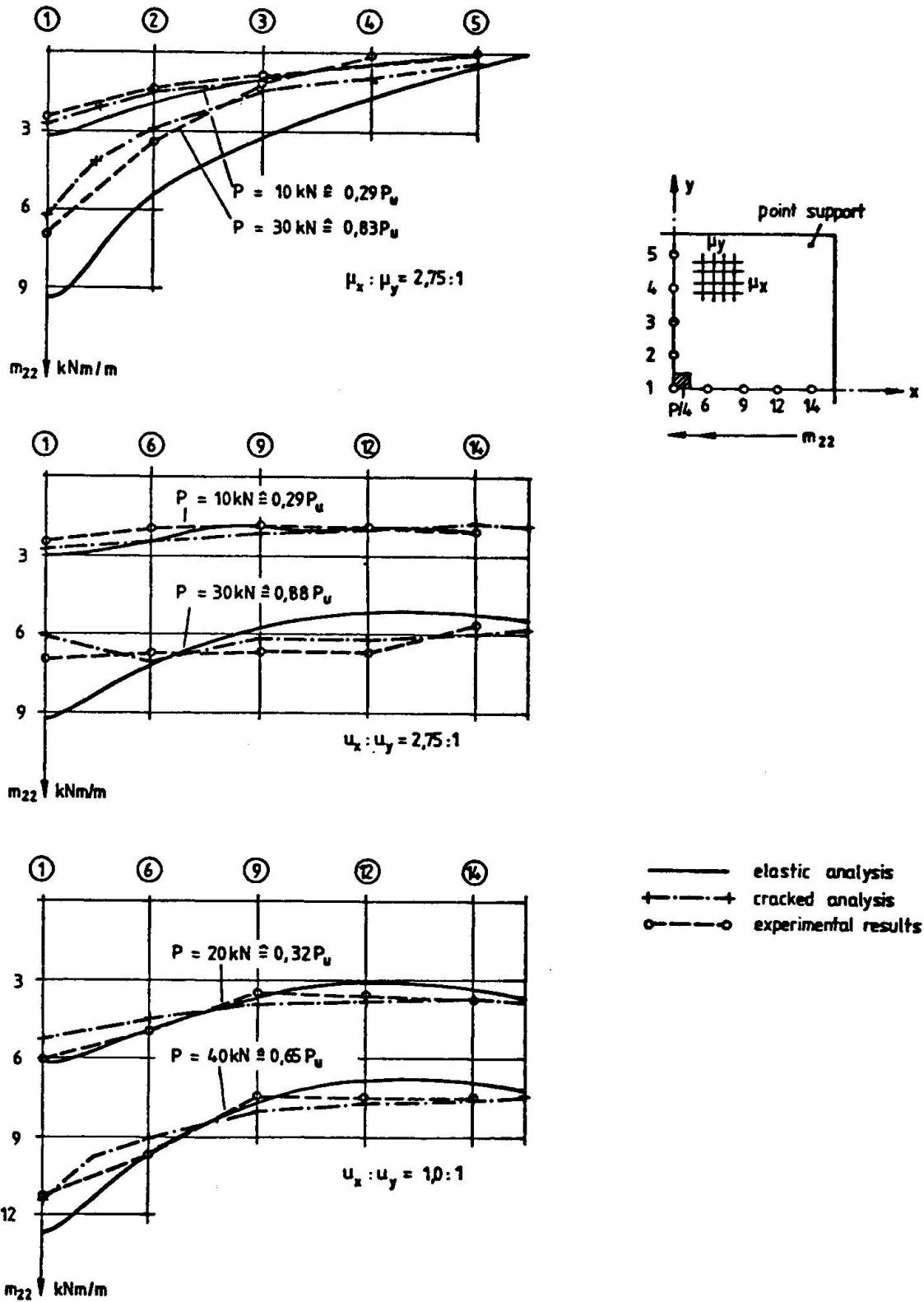

Fig. 4 Experimental and Analytical Distribution of Moments m_{22} in Axes of Symmetry [19]



For the near future the author predicts a rare application in practical design work, but a steadily increasing use in many fields of research.

3. EXAMPLES OF APPLICATIONS

Discussing now some examples where advanced mechanics have been applied the author does not strive for a complete representation of what has been done in the past as already given in earlier publications (e.g. [24]).

There are many well known studies and applications which are often quoted in the relevant literature, as e.g. by NGO/SCORDELIS [13], SCORDELIS/NGO/FRANKLIN [14], NILSON [5], FRANKLIN [6], CEDOLIN/DEI POLI [7], JOFRIET/McNIECE [8], BELL/ELMS [9], BERG et al. [10] CERVENKA [12], WEGENER et al. [11], HAND/PECK-NOLD/SCHNOBRICH [18], SCHIMMELPFENNIG [15], EBBINGHAUS [16], GRÜNBERG [17], and last not least by ZIENKIEWICZ et al. and ARGYRIS et al. to mention some arbitrarily chosen authors. A more complete historical review has been recently given by SCORDELIS [4].

Problems of cyclic loading as well as studies treating time dependent creep behaviour will be discussed by other reports.

For a great number of successful special applications in reactor technology even in cases of threedimensional structures the reader is referred to reports published on occasion of SMIRT (STRUCTURAL MECHANICS in REACTOR TECHNOLOGY) -conferences.

In the following only such investigations are shortly mentioned, which have been published recently, are not so well known or by which some special trends may be shown. Completeness cannot be reached.

Of general interest for reinforced concrete research are investigations of SCORDELIS (chapt. 4 in [4]) (fig. 2) which are very helpful in discussing the shear-failure of RC-slabs without stirrups, a problem which has been treated for a long time within the Comité Euro-International du Béton (CEB) when the Model Code was made. An even more enlarged systematic study would be very desirable.

Also of great practical importance are investigations as done by DUDDECK et al. [19] (fig. 3. 4) where the service-ability of concrete slabs with different meshes of reinforcement are studied by test as well as computation. As in most European countries slabs are designed according to their ultimate limit state, not much care has been taken to watch the cracking behaviour, possible corrosion and maximum deflection under service loads. Damages in several countries brought this subject to discussion again.

With these advanced mechanics under considerations probably the greatest practical success has been gained by the computation of slender columns taking into account second order effects. Very effective work has been done by KORDINA in Germany and during the last years by MENEGOTTO in Italy.

In the CEB-Manual "Stability" a selection of 503 experimentally tested columns is compared with corresponding calculations giving a median $N_{test}/N_{cal} = 1,06$ with a coefficient of variations 0,136.

At the author's institute an investigation by KESTING [20] (fig. 5, 6) has been carried out by means of layered elements and dynamic relaxation to study the stability of prefabricated wall panels. Here in contrary to columns and plates the modelling of tension-stiffening as the stabilizing effect proved decisive for the bearing capacity [28]. This latter results probably may be generalized for other kinds of twodimensional structures as e.g. for hyperbolic cooling towers and cylindrical shells endangered by second order effects.

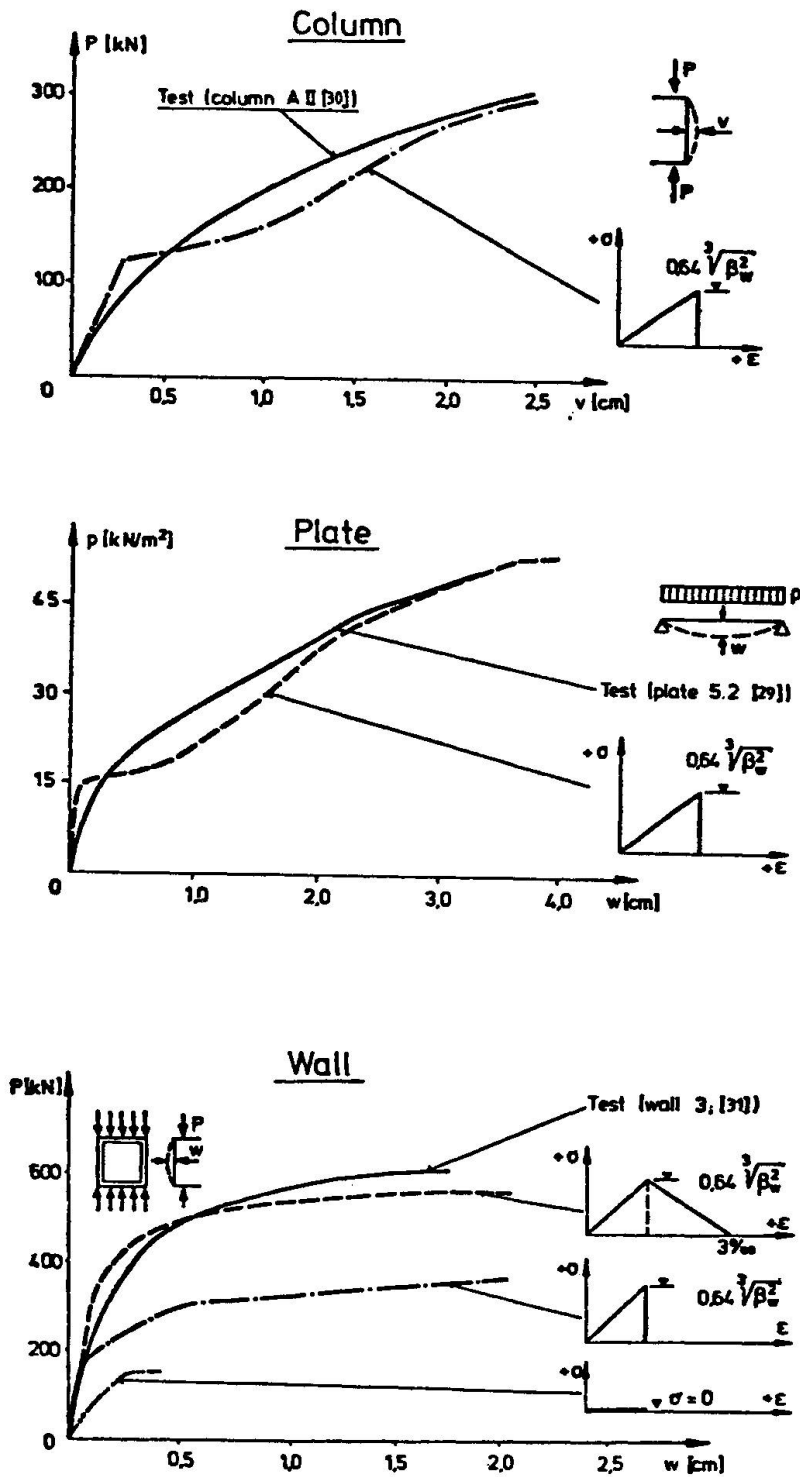
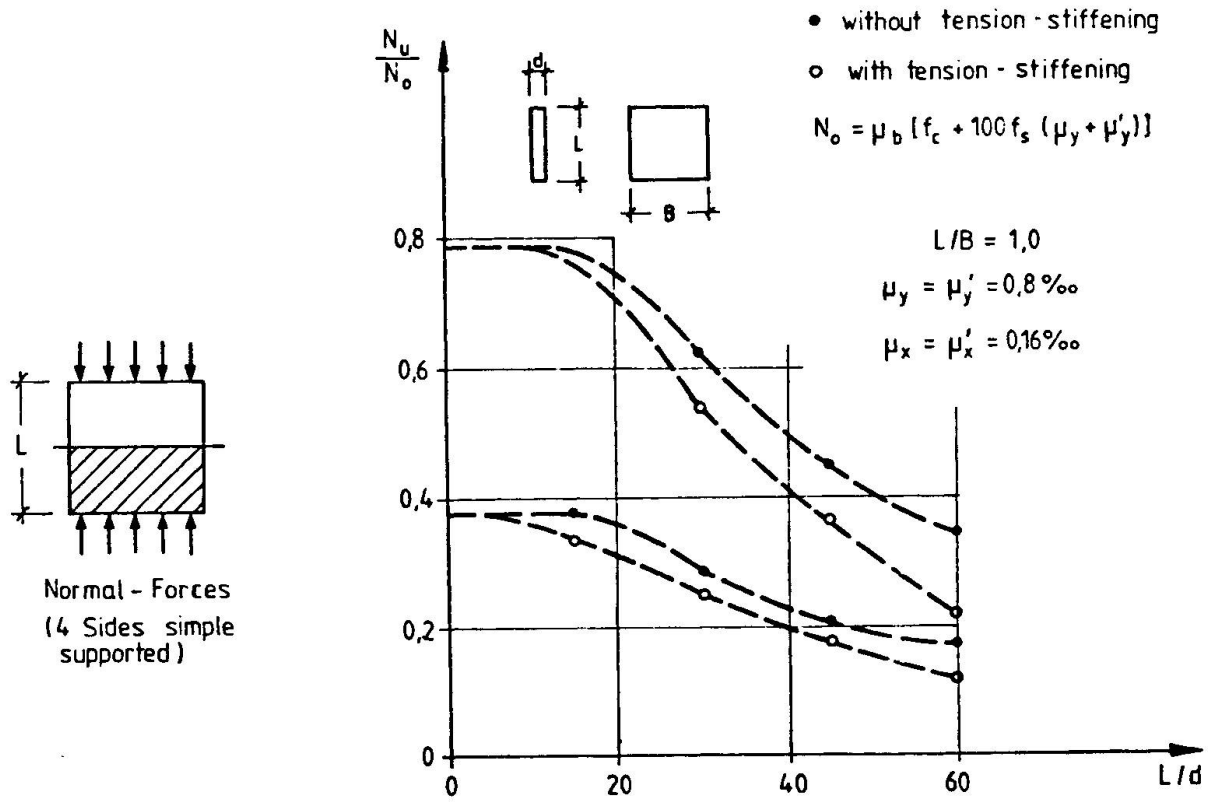

Fig. 5 Comparison- Calculations with Different Assumption for Tension- Stiffening [28]



MAIN NORMAL FORCES

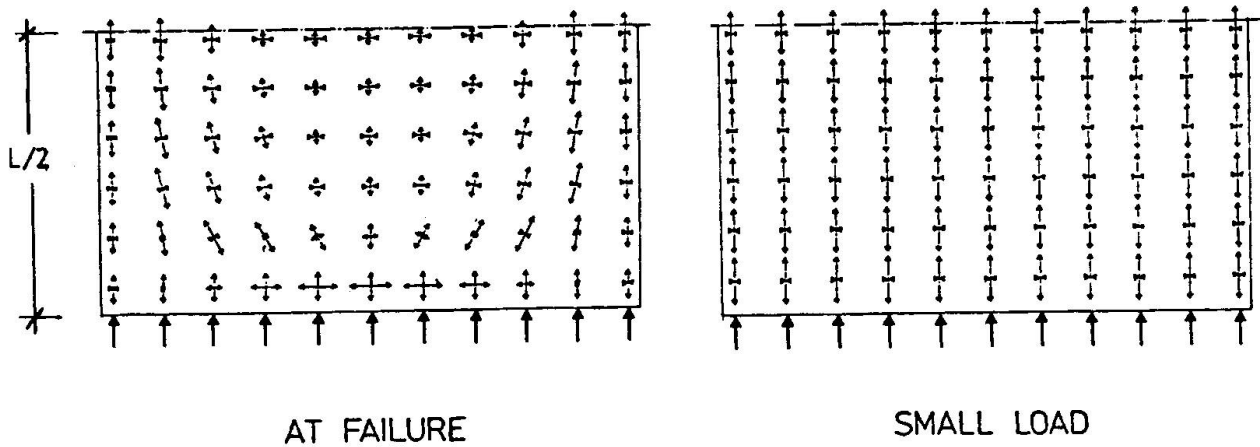

Fig. 6 Bearing Behaviour of RC- Walls Including Second Order Effects [28]

Interesting investigations by CRANSTON et. al [32] to study these tension-stiffening effects experimentally in greater detail are still under progress in the United Kingdom (fig. 7).

Principle calculations similar to [20] have also been done by KRISTJANSON [21] and earlier by BERGAN [22]. In [21] also results for skew slabs are given showing that with an increasing number of cracks a significant change of the bearing behaviour occurs which is important for practical design work (fig. 8).

The fact that modern numerical methods may be a great help in analyzing shells has been confirmed among others by MÜLLER/KABIR/SCORDELIS [23] recently, who investigated a hyperbolic paraboloid as a gable-, saddle- and inverted umbrella shell including creep and shrinkage.

New and important impact problems have been put forward in connection with nuclear power plants and offshore platforms.

So a study of contact problems has been published recently by NILSON [25] (fig. 11). The fact that his theoretically gained results do not agree very well with experimental values may also be due to the fact that thermal effects have been abandoned. Own experiments show that there is a remarkable heating of material surfaces under high velocity impact.

Problems of spalling and penetration of RC-slabs under high impact loading can only be explained in a consistent manner if the dispersion of impact waves and the resulting stresses are computed. The threedimensional problem may be simplified in many cases to a simpler twodimensional problem, because of rotational symmetry. Fig. 12 shows some results calculated by SÜPER [26] for concrete slabs, similar to elasto-plastic solutions gained already by KAWAI [27] and others, which seem to be in rather good agreement with own tests carried out.

Interesting calculations of stresses due to temperature caused by cement hydration, which are to be compared with measurements at a bridge still under progress, have just been finished by ZEITLER [33].

4. FUTURE APPLICATIONS - PROBLEMS TO BE SOLVED

In the following chapter the author wants to represent a few quite arbitrarily chosen two- and three-dimensional problems which to his opinion offer wide and fields of application for the methods in discussion:

Two-dimensional RC-problems

As prefabrication becomes more and more important - not only because of economical reasons but also because of a lack of skilled craftsmen in developed countries - high strength concrete and therefore slender structures endangered by stability-failures have to be studied. This statement is true for panels and slabs, high girders as well as for special frequently used shell-structures cast in situ such as cooling towers e.g. Realistic stability experiments where necessary deformations are not hindered and conservative or nonconservative loads are imposed in agreement with reality are very difficult and expensive. So experimental research must be restricted to a small number of carefully carried out tests. Here advanced numerical methods should be used to extend our knowledge by varying necessary parameters.

Another interesting and still discussed technical problem is combined bending and shear in the webs and flanges of T-beams. Although further tests are necessary especially for cases where failure is due to exceeding compressive strength, F.E.-methods based on realistic RC-behaviour could be very helpful.

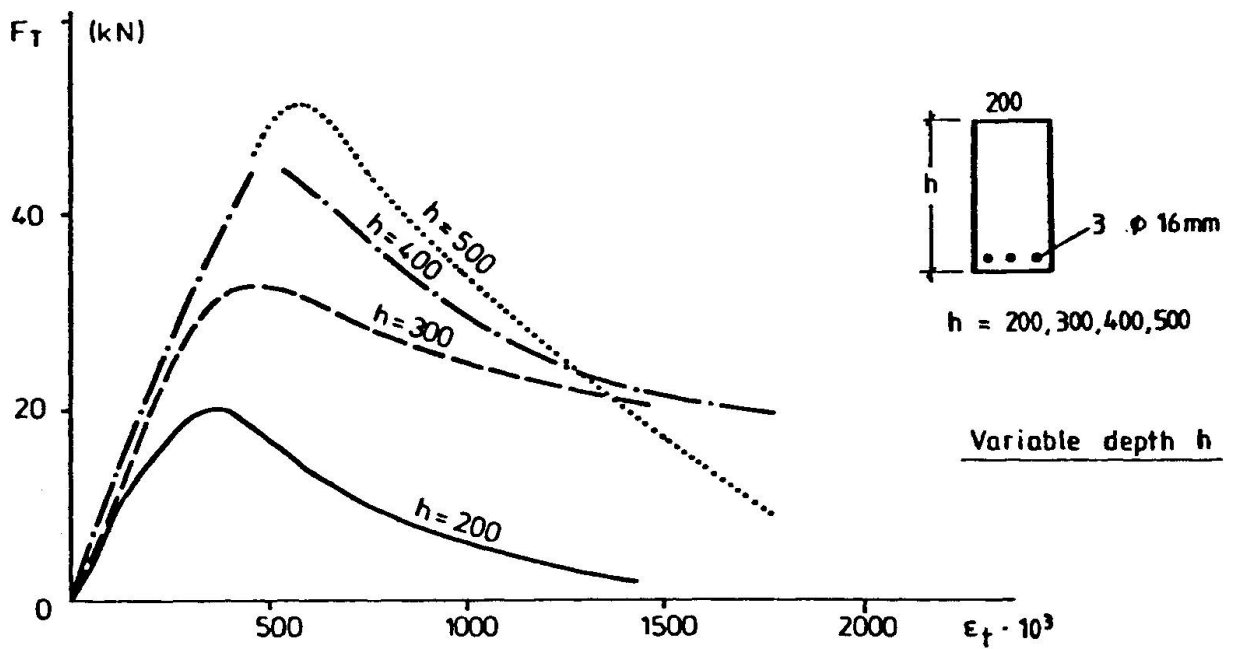
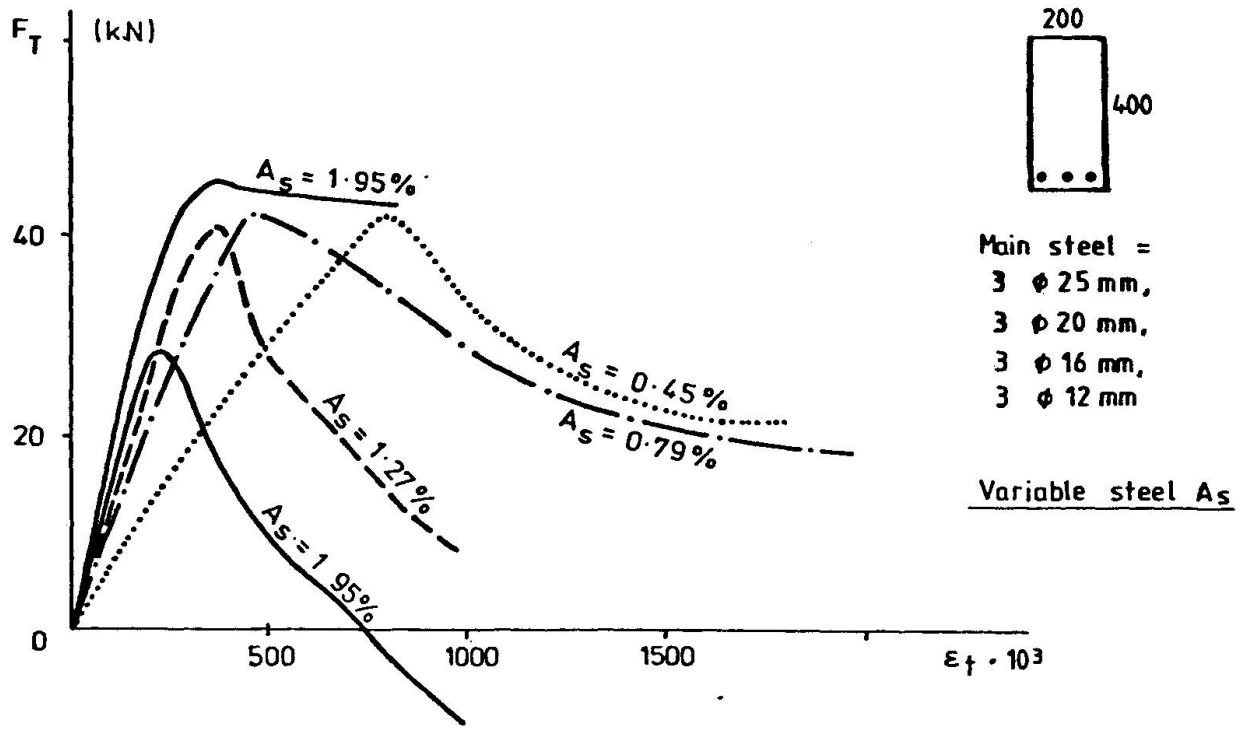
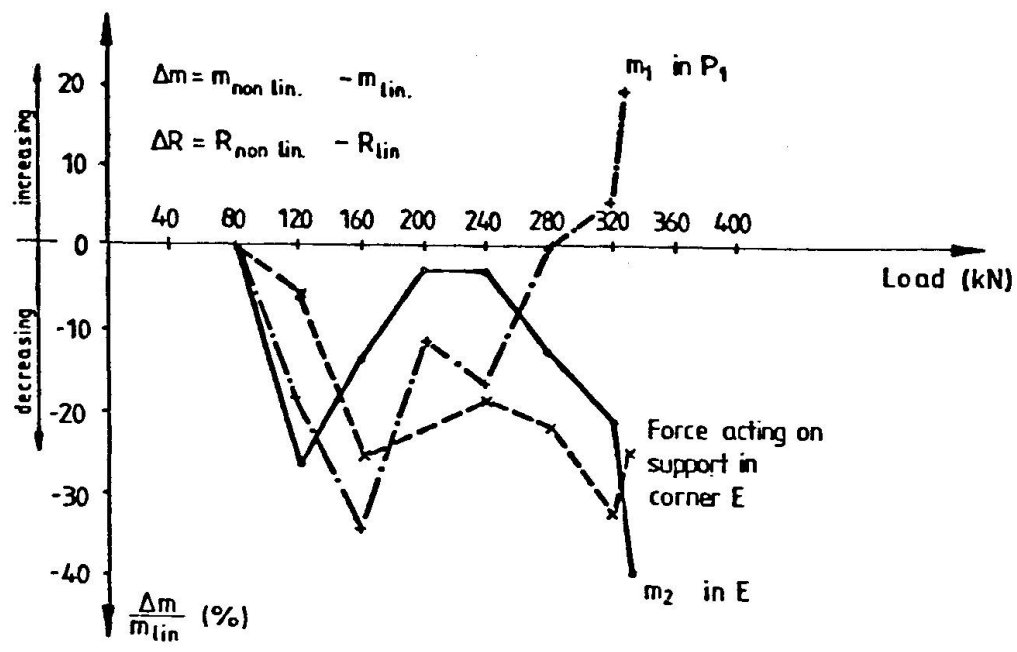

Fig. 7 Tension Force versus ϵ_t According to Experiments [32]



m_1, m_2 main moments

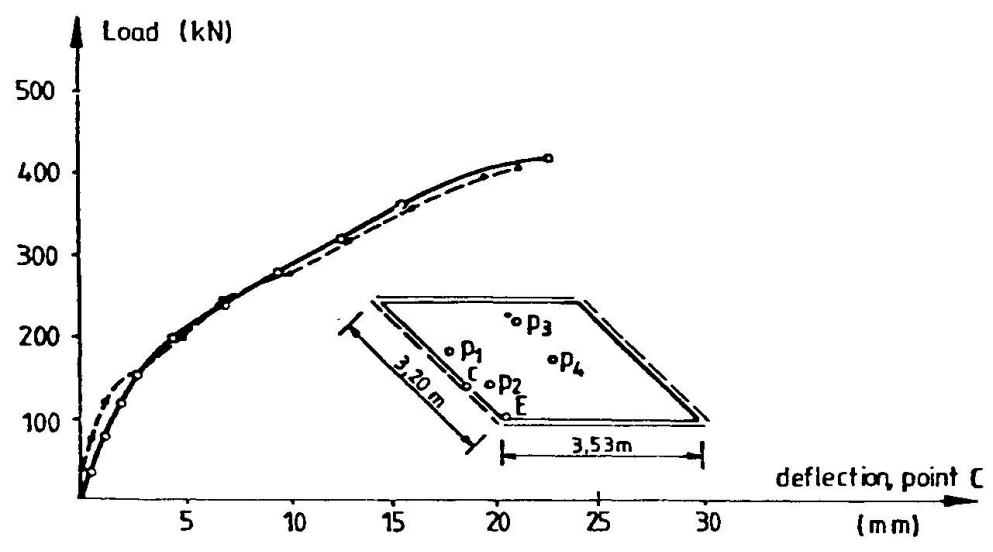
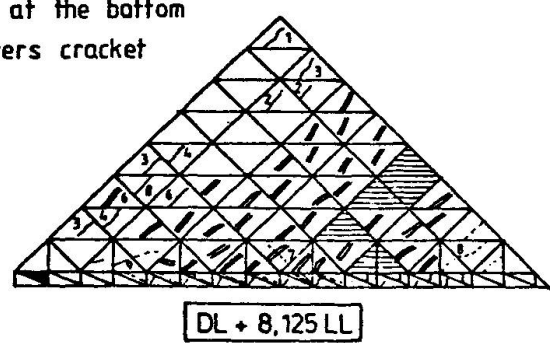
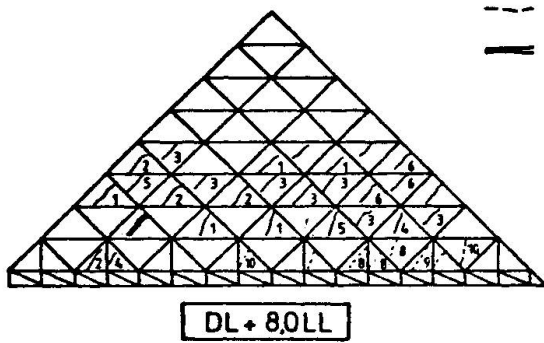
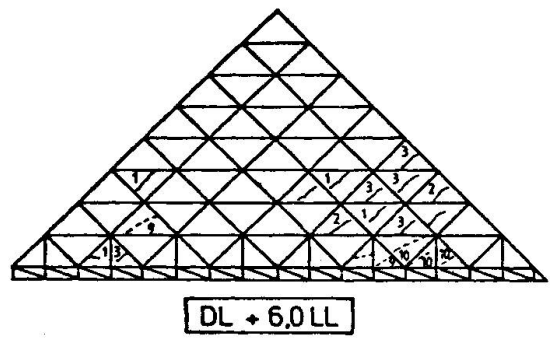
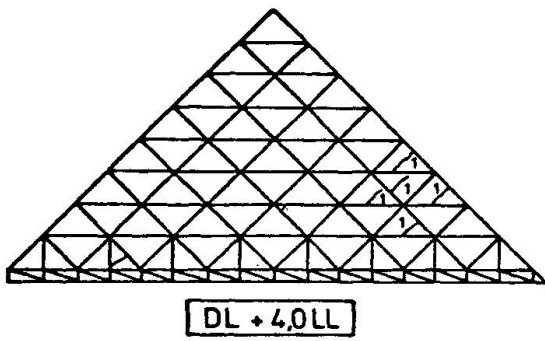
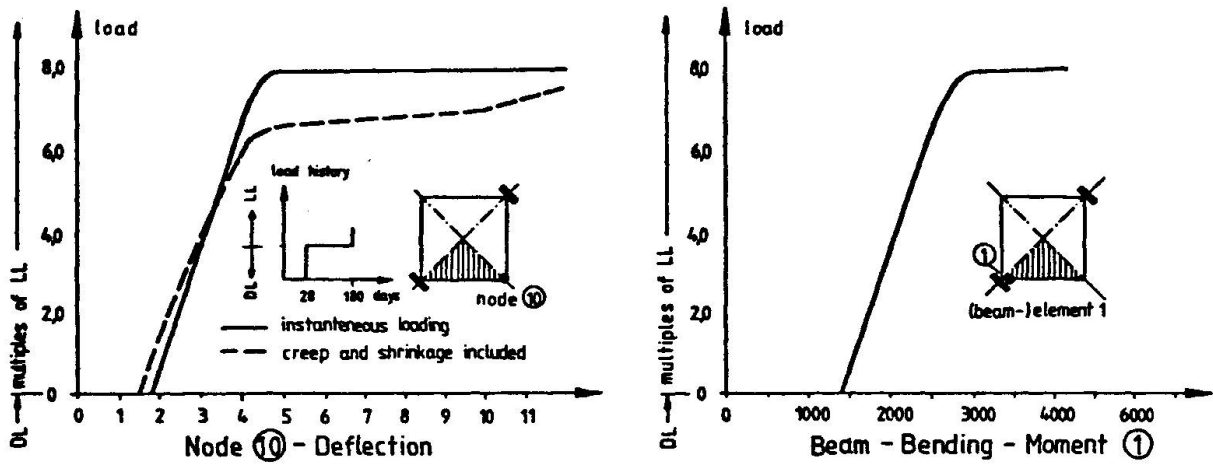

Fig. 8 Bearing Behaviour of Skew Slab [24]



- Cracks at the top
- - - Cracks at the bottom
- All layers cracket

Fig. 9 Results for Saddle Shell [23]



Corbels as shear members belong to the same category of possible tasks.

For frequently used shell containments nearly no results are available concerning their behaviour under imposed deformations due to temperature effects or due to settlements. While some structures are very insensitive to these kind of "loading" there are other structures endangered by stability-failure where cracks and therefore reduced stiffness is of decisive importance, not to mention corrosion problems which right now become of major importance at least in the author's country.

In many structures being built to guarantee sufficient energy-supply such as off-shore platforms, LNG(Liquid Natural Gas)-containers and especially nuclear reactors impact problems are of major concern. With the latter it may be stated that impact loading in many cases determines the concrete-thickness of containment walls and the necessary reinforcement and therefore to a high extent the building costs of a nuclear power plant. Own experimental and theoretical studies show that there is a real need for more advanced numerical procedures in this field.

That simple cases of vehicle impact caused by trucks and locomotive are still of interest has been shown by a number of latest accidents, where collapsing bridges killed and injured people.

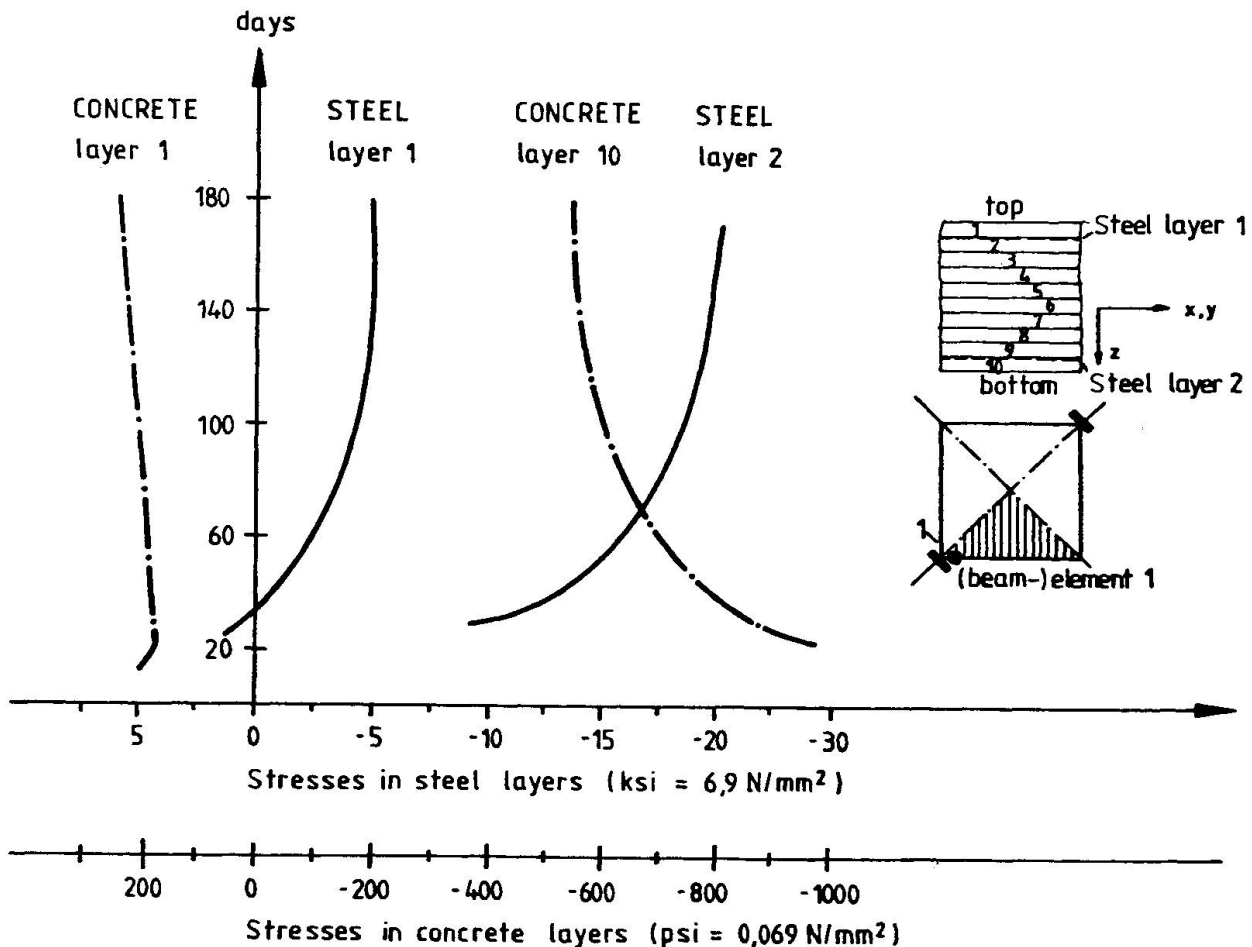

Fig. 10 Stresses Redistribution in Beam (Element 1)

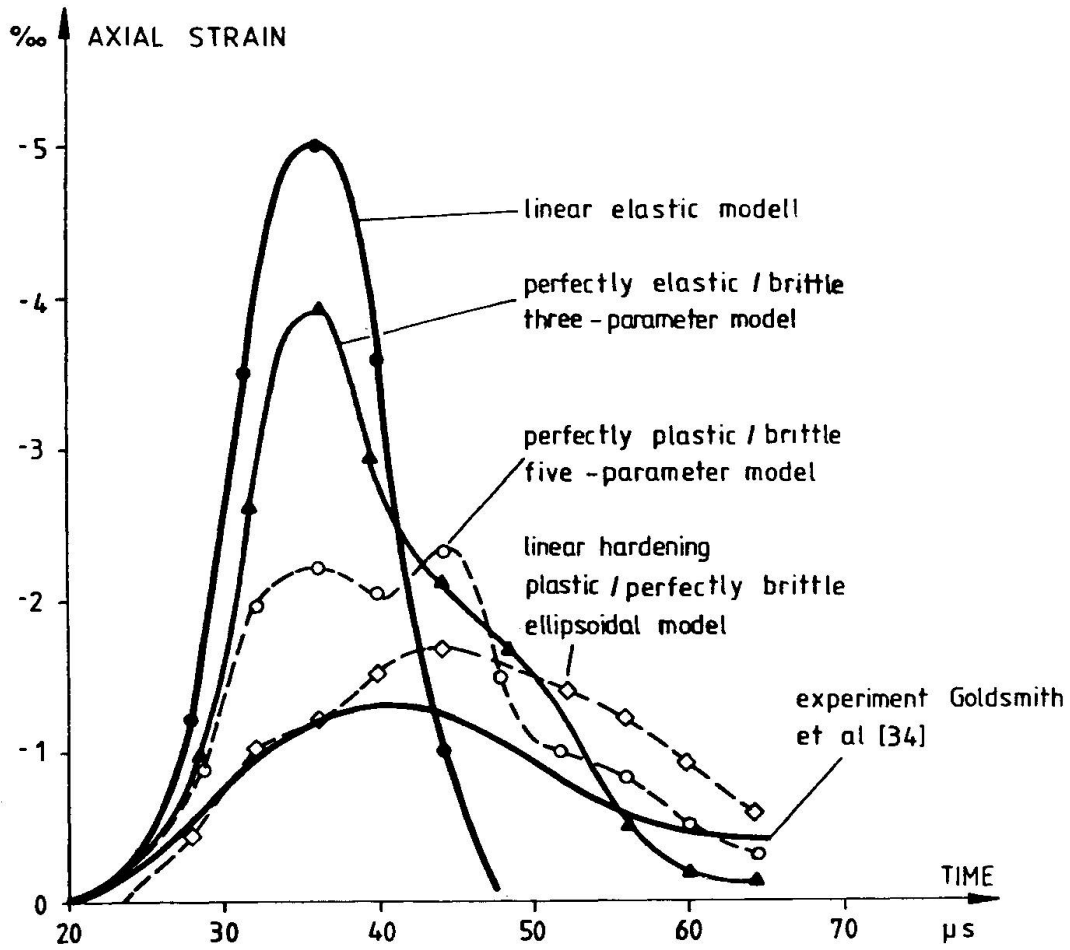
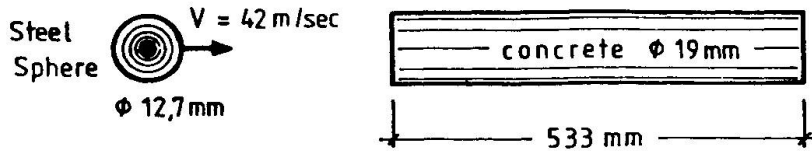

Fig. 11 Contact Problem- Different Constructive- Laws [25]

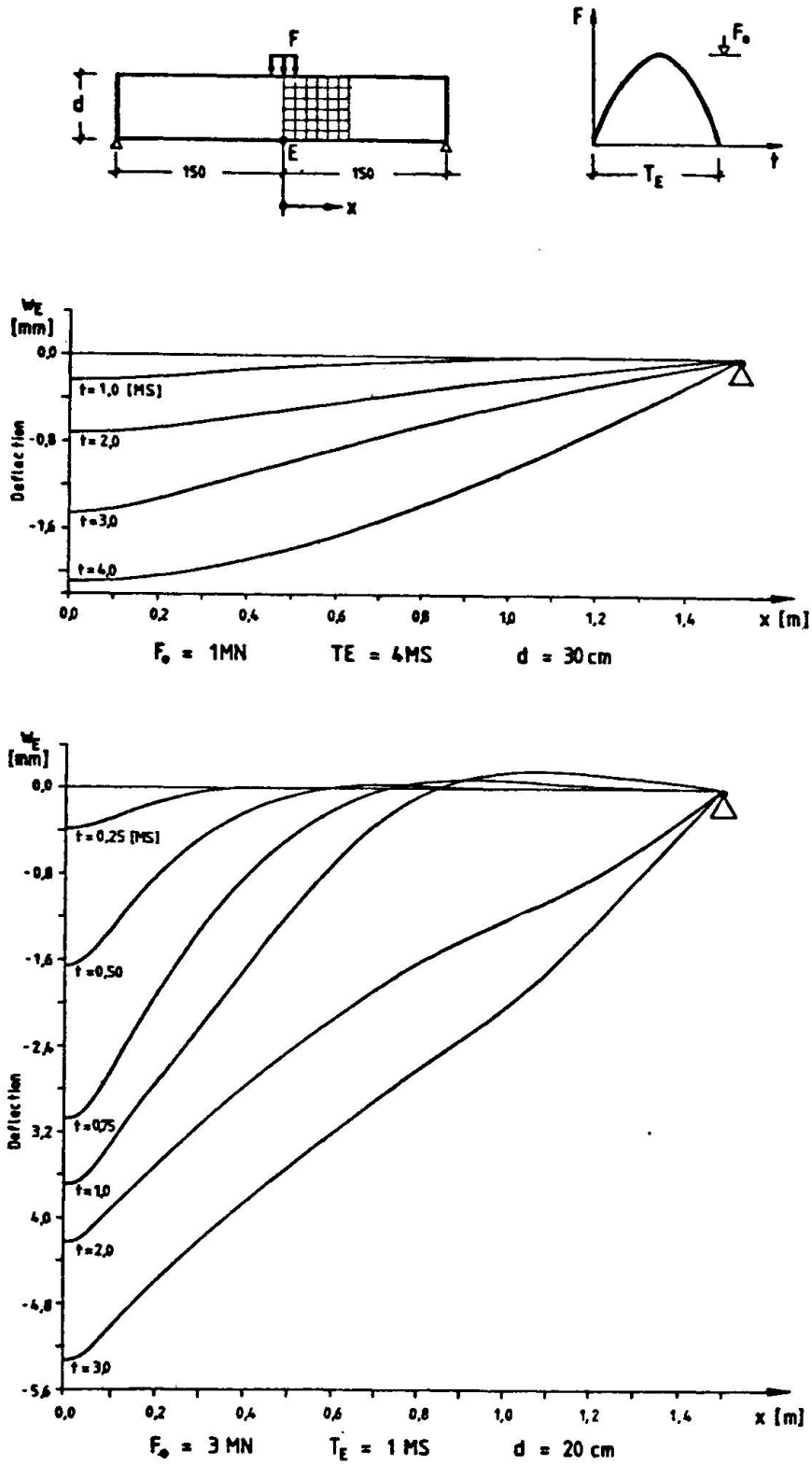

Fig. 12 Midpoint E- Deflection of Thick Slab Under Impact [26]

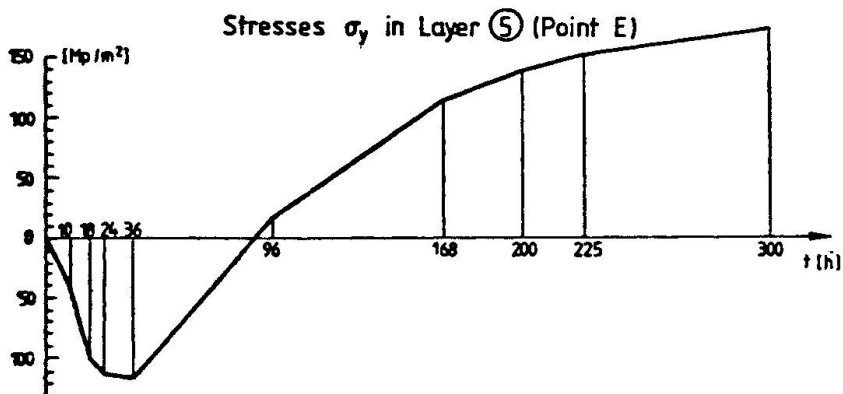
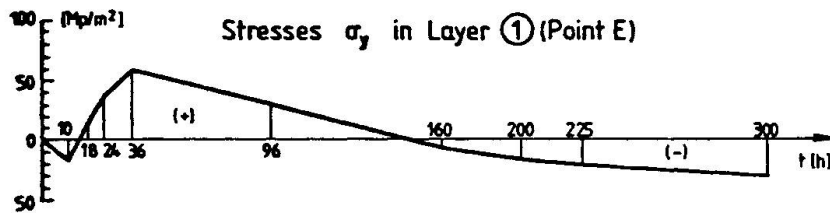
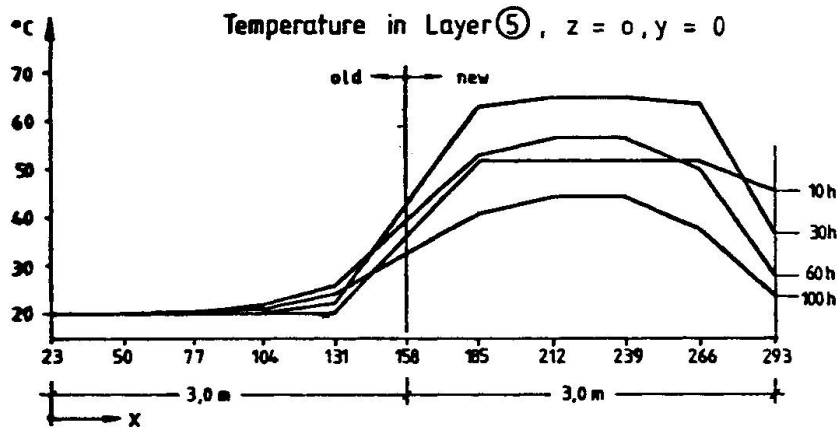
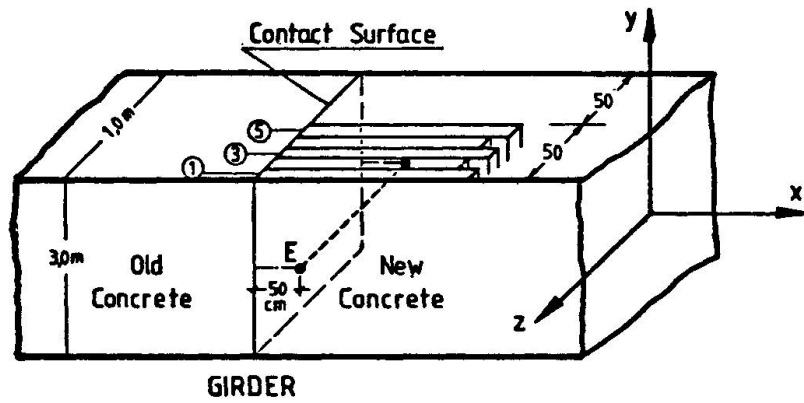

Fig. 13 Stresses in The Web of a Bridge- Girder Due to Hydration of Concrete [33]



- Three-dimensional RC-problems

There are rather simple and commonly used structures such as flat slabs and their punching behaviour which demand reasonable threedimensional investigations. Especially flat RC-slabs prestressed without bond, which are increasingly used for office buildings and factory halls raise new discussions.

Also in many cases where edge beams support slabs or shells the torsional stiffness of the beams require threedimensional treatment. E.g. near the supports of bridge-superstructures which consist of a double T cross-section without any further web connection because of the manufacturing process these effects are of great importance for an economic solution.

The fact that there is a great need for such methods with all thick threedimensional structures e.g. for reactor containments is well known and must not be emphasized. Here more complex investigations including temperature, time and even moisture are desirable.

5. NECESSARY RESEARCH

As there are other reports on necessary research there is no need to treat this subject here in greater detail. The author just wants to mention some problems where from the applications point of view, intensified research is desirable. These are

- A realistic investigation of the descending branch of the concrete-constitutive law including the rotational capacity of RC-slabs and RC-beams eventually at high strain rates.
- Constitutive laws for concrete including more complex loading histories than unidirectional monotonic loading. Even cyclic loading - though not sufficiently explored - is still a rather restricted loading process.
- Tension stiffening because of its great importance for the bearing capacity of structures endangered by stability-failure.
- An experimental verification of threedimensional creep laws possibly under varying temperature.

The first item is important in all cases where realistic collapse loads are to be calculated. As for impact and dynamic loading the energy absorption is decisive the rotational capacity has to be taken into account in a realistic manner.

The second problem needs clarification with respect to safety considerations. After a complex history low safety-factors for a special favourable multiaxial compression-situation can only be allowed if the real behaviour including this history is known.

The last two subjects are of great importance for all structural systems where the bearing capacity is endangered by second order effects. Here a realistic simulation of stiffness is decisive.



6. CONCLUSIONS

From my statements the following conclusions should be drawn:

- The newly developed methods are well apt to be used in research and may be a great help in exploring reinforced concrete behaviour. In many cases, as shown, the agreement between experimental and calculated results seems to be better, than justified by the scatter of concrete characteristics.
- Besides further research investigations should be done striving to simplify gained knowledge.
- Written computer programs should be really applied in simulated experiments.
- Communication problems between theoretically drained and design engineers, which are not to be underestimated, have to be overcome.

REFERENCES

- [1] Haas, W. Normengerechte Berücksichtigung des zeitabhängigen Verformungsverhaltens von Beton, dargestellt an zwei Beispielen aus dem Hoch- und Brückenbau Finite Elemente in der Baupraxis, Verlag Wilhelm Ernst & Sohn, Berlin-München-Düsseldorf 1978
- [2] Pfaffinger, D. Thielen, G. Limit Load Analysis of a Concrete Structure 5th Nastran European Users Conference, Munich 1978
- [3] Schnobrich, W.C. Slab Problems Chapter 4 in Analisi Delle Strutture In Cemento Armato Mediante il Metodo Degli Elementi Finiti, Politecnico di Milano 1978
- [4] Scordelis, A.C. Finite Element Modelling of Reinforced Concrete Structures, Chapt. B1 in Analisi Delle Strutture In Cemento Armato Mediante il Metodo Degli Elementi Finiti, Politecnico di Milano 1978
- [5] Nilson, A.H. Nonlinear Analysis of Reinforced Concrete by the Finite Element Method ACI-Journal No. 9, Sept. 1968
- [6] Franklin, H.H. Non-linear Analysis of Reinforced Concrete Frames and Panels Ph.-D. Thesis University of California, Berkeley 1970
- [7] Cedolin, L. Dei Poli, S. Finite Element Nonlinear Analysis of Reinforced Concrete Bidimensional Structures Techn. Report No. 50, ISTC 1974
- [8] Jofriet, J.C. McNiece, G.M. Finite Element Analysis of Reinforced Concrete Slabs Journ. of the Structural Div., ASCE No. ST3, 1971

- [9] Bell, J.C.
Elms, D. Partially Cracked Finite Elements
Journ. of the Structural Div., ASCE No. ST7, 1971
- [10] Berg, S.
Bergan, P.G.
Holand, J. Nonlinear Finite Element Analysis of Reinforced
Concrete Plates
SMIRT-Conference M3/5, Berlin 1973
- [11] Wegener, R.
Duddeck, H. Der gerissene Zustand zweiseitig gelagerter Plat-
ten unter Einzellasten - Nichtlineare Berechnung
mit Finiten Elementen
Beton- und Stahlbetonbau - 70, 1975
- [12] Cervenka, V. Inelastic Finite Element Analysis of Reinforced
Concrete Panels under In-Plane Loading
Eng. Res. Center, University of Colorado,
Boulder 1970
- [13] Ngo, D.
Scordelis, A.C. Finite Element Analysis of Reinforced Concrete Beams
ACI Journal, No. 3, March 1967
- [14] Scordelis, A.C.
Ngo, D.
Franklin, H.A. Finite Element Study of Reinforced Concrete Beams
with Diagonal Tension Cracks
Proc. of Symp. on Shear in Reinf. Conc., ACI-
Publication SP-42, 1974
- [15] Schimmelpfennig, K. Bruchsicherheitsberechnung von Spannbetondruckbe-
hältern
DAFStb, Heft 257, Wilhelm Ernst & Sohn, Berlin 1976
- [16] Ebbinghaus, P. Herleitung eines Verfahrens zur Berechnung von
Stahlbetonscheiben unter Berücksichtigung der
Rißentwicklung. TH Aachen, Dissertation 1975
- [17] Grünberg, J. Berechnung von ebenen Stahlbetonflächentragwerken
bei gerissenem Zustand mit der FE-Methode
Werner-Verlag, Düsseldorf 1974
- [18] Han, F.R.
Pecknold, D.H.
Schnobrich, W.C. Nonlinear Layered Analysis of RC Plates and Shells
Journ. of the Struct. Division St 7, 1973
- [19] Duddeck, H.
Griebenow, G.
Schaper, G. Material and Time Dependent Nonlinear Behaviour
of Cracked Reinforced Concrete Slabs - Finite
Element Analysis and Laboratory Tests
IASS-Symposium, Vol. I, Darmstadt 1978
- [20] Kesting, K. Berechnung von Stahlbetonwänden und Platten
unter Berücksichtigung geometrischer und physika-
lischer Nichtlinearität
Diss. Universität Dortmund, Mitt. d. Lehrst. f.
Beton- u. Stahlbetonbau, Nov. 1979
- [21] Kristjanson, R. Physikalisch und geometrisch nichtlineare
Berechnung von Stahlbetonplatten mit Hilfe Finiter
Elemente. Diss. TH Darmstadt 1977
- [22] Bergan, P.G. Nonlinear Analysis of Plates Considering Geometric
and Material Effects
Report No. 72-1, University of Trondheim



- [23] Müller, G. Kabir, A.F. Scordelis, A.C. Nonlinear Analysis of Reinforced Concrete Hyperbolic Paraboloid Shells IASS-Symp. Vol. I, Darmstadt 1978
- [24] Eibl, J. Iványi, G. Studie zum Trag- und Verformungsverhalten von Stahlbeton DAFStb, Heft 260, Verlag Wilhelm Ernst & Sohn, Berlin-München-Düsseldorf 1976
- [25] Nilson, L. Finite Element Analysis of Impact on Concrete Structures F.E. in Nonlin. Mech. Vol. 2 Norwegian Inst. of Techn., Trondheim 1977
- [26] Süper, W. Ausbreitung von Stoßbeanspruchungen in Stahlbetonplatten (in Vorbereitung) Mitt. d. Lehrst. f. Beton- u. Stahlbetonbau, Universität Dortmund
- [27] Kawai, T. New Discrete Structural Models and Generalizations of The Method of Limit Analysis F.E. in Nonlin. Mech., Vol. 2 Norwegian Inst. of Techn., Trondheim, 1977
- [28] Eibl, J. Kesting, K. Numerical Investigation of Slender, Reinforced Concrete Walls IASS-Symp., Darmstadt 1978, Werner-Verlag, Düsseldorf 1978
- [29] Franz, G. Über die Beanspruchung der Berechnung bei kreuzweise bewehrten, vierseitig frei drehbar gelagerten Rechteckplatten aus Stahlbeton Untersuchungsber. Inst. für Beton- u. Stahlbeton, Universität Karlsruhe 1970
- [30] Kordina, K. Maack, P. Hjorth, O. Traglastermittlung an Stahlbetondruckgliedern Inst. f. Baustoffkunde, Massivbau und Brandschutz, Heft 219, TU Braunschweig 1974
- [31] Storkebaum, K.H. Ein Beitrag zur Traglastermittlung von vierseitig gelagerten Stahlbetonwänden Diss. TU Braunschweig 1977
- [32] Cranston, W.B. Clark, L.A. Speirs, D.M. Tension Stiffening in Reinforced Beams and Slabs Res. Seminar - Cem. & Conc. Ass. Training Centre, Fulmer 1977
- [33] Zeitler, W. Nichtlineare Temperatur- und Spannungsberechnung (in Vorbereitung) TU Darmstadt 1980
- [34] Goldsmith, W. Polinka, M. Yang, T. Dynamic behaviour of Concrete Exp. Mech. Feb. 1966
- [35] Popasen, J. Löbel, L. Tunnenbaum, M. Modellversuch für normale und schiefe Stahlbetonplattenbrücken Bautechnik, Verlag Wilhelm Ernst & Sohn, Berlin 1973