

**Zeitschrift:** IABSE reports = Rapports AIPC = IVBH Berichte  
**Band:** 40 (1982)

**Artikel:** Method for optimum design of building systems  
**Autor:** Lesniak, Zdzislaw K. / Schwarz, Heinz  
**DOI:** <https://doi.org/10.5169/seals-30894>

### **Nutzungsbedingungen**

Die ETH-Bibliothek ist die Anbieterin der digitalisierten Zeitschriften. Sie besitzt keine Urheberrechte an den Zeitschriften und ist nicht verantwortlich für deren Inhalte. Die Rechte liegen in der Regel bei den Herausgebern beziehungsweise den externen Rechteinhabern. [Siehe Rechtliche Hinweise.](#)

### **Conditions d'utilisation**

L'ETH Library est le fournisseur des revues numérisées. Elle ne détient aucun droit d'auteur sur les revues et n'est pas responsable de leur contenu. En règle générale, les droits sont détenus par les éditeurs ou les détenteurs de droits externes. [Voir Informations légales.](#)

### **Terms of use**

The ETH Library is the provider of the digitised journals. It does not own any copyrights to the journals and is not responsible for their content. The rights usually lie with the publishers or the external rights holders. [See Legal notice.](#)

**Download PDF:** 07.02.2025

**ETH-Bibliothek Zürich, E-Periodica, <https://www.e-periodica.ch>**

## Method for Optimum Design of Building Systems

Méthode d'optimisation des constructions

Optimierungsmethode für Bausysteme

### Zdzislaw K. LESNIAK

Professor Dr.  
Univ. Hamburg  
Hamburg, Fed. Rep. of Germany



Zdzislaw K. Lesniak born 1924, worked as a Civil Engineer first in a design office and then on site. Later he carried out research in experimental stress analysis and fatigue testing. Now his research is devoted to computer aided and optimization problems. He is Professor at the Technological University of Bialystock and at this time visiting Professor at the University of Hamburg.

### Heinz SCHWARZ

Professor Dr.-Ing.  
TU Darmstadt  
Darmstadt, Fed. Rep. of Germany



Heinz Schwarz born 1923, has worked as a Civil Engineer since 1949 and has held various positions in structural engineering till 1969. He obtained his doctorate in 1962 and since 1970 has been Professor of Information Processing in Building and Civil Engineering Organisations.

### SUMMARY

The optimum design of larger building systems as a whole encounters computational limitations even if big computers are utilized. Decomposition of the optimization models to elements, which can be treated separately, maintaining their mutual interdependence by coordinating variables is applicable to a certain class of systems. A pragmatic approach to optimize such members of that class, the elements of which cannot be treated parallelly and independently for each set of coordinating variables, is presented. This approach yields an upper and a lower limit of the optimum and shows immediately the reachable optimization profit.

### RESUME

La conception optimale de grandes constructions, dans leur ensemble, se heurte à des limitations de calcul même sur un ordinateur puissant. La décomposition du modèle à optimiser en éléments traités séparément, mais dont les interdépendances sont traduites par des variables de coordination est applicable à une certaine classe de systèmes. L'article propose une approche pragmatique permettant l'optimisation, dans les situations où les éléments ne peuvent pas être traités parallèlement ou indépendamment, pour des valeurs données des variables de coordination. Cette méthode permet d'obtenir une enveloppe dans laquelle se situe l'optimum et fournit immédiatement le gain prévisible de l'optimisation.

### ZUSAMMENFASSUNG

Beim optimalen Entwerfen grösserer Bausysteme stösst man sehr bald an Grenzen des Rechenaufwandes, auch wenn sehr leistungsfähige DV-Anlagen eingesetzt werden. Dekomposition der Optimierungsmodelle in Elemente, die getrennt behandelt werden können, wenn ihr Zusammenhang durch Koordinationsvariable gewahrt wird, lässt sich auf die Angehörigen einer bestimmten Systemklasse anwenden. Ein pragmatischer Ansatz zum Optimieren solcher Angehöriger dieser Klasse, deren Elemente bei gegebenen Werten der Koordinationsvariablen nicht parallel und unabhängig voneinander behandelt werden können, wird vorgelegt. Er liefert eine Ober- und Untergrenze des Optimums und zeigt unmittelbar den erreichbaren Optimierungsgewinn.

## 1. INTRODUCTION

Every building or civil engineering work may be considered to be a system, consisting of several subsystems which are mutually interconnected by their functional contribution to the whole building's performance. The optimum design of such a system as a whole encounters computational limitations because its model has to be described by a large number of decision variables and complicated behaviour functions. If on the other hand a system has certain special properties, then its optimization model might be decomposed to elements which can be treated separately, maintaining their mutual interdependence by coordinating variables.

The decomposition method may be applied to systems with rather loosely connected elements. In [1] such a class of building systems is being defined. The defining property of all systems belonging to this class is that their elements can be put in a unique sequence according to the direction of the decisive effect's flow through the system. The decisive effect is the one which the system has to transmit mainly and which has to be regarded in the constraints. Typical examples are statically determinate structures which carry loads "top down" without feedback. Similar system behaviour show inter alia pipe nets and heat supply - heat accumulation systems.

Another property of this class of systems can be derived from the systems's optimization model. As is well known, a mathematical optimization model consists of the objective function and several constraints, all of them being functions of the decision variables.

The sets of decision variables describing systems which are members of the class under consideration characteristically may be divided into disjoint subsets. One of these subsets contains all the coordinating variables which are assigned to more than one subsystem. Each of the other subsets assembles the local variables which are assigned to just one of the subsystems. Hence the whole vector of decision variables  $x$  falls into subvectors:  $y$  (of the global variables) and  $z_i$  (of the  $p$  subsystems):

$$x = (y, z_1, z_2, \dots, z_p), \quad (p = \text{number of subsystems})$$

$$z_j \cap z_k = \emptyset \text{ for } j, k = 1, 2, \dots, p, \quad j \neq k$$

A system may be optimized by coordinated decomposition if (1) the total number of local variables is much higher than the number of the coordinating ones, if (2) the objective function is either of the additive type

$$f(x) = \sum_{i=1}^p f_i(y, z_i)$$

or of the multiplicative one

$$f(x) = \prod_{i=1}^p f_i(y, z_i)$$

and if (3) the constraint matrix shows a special pattern.

The constraint matrix is a binary valued one, indicating the decision variables' occurrence in the inequations which describe the constraints. Each of its columns is assigned to one of the decision variables, each of its rows to one of the constraints. A non zero element announces, that the constraint, to which the respective row is assigned, is a function of the variable, to which the column is assigned (fig 1). Arranging the constraints (the rows) appropriately we may try to produce either a cascade (fig.2.1) or even a quasi-block-diagonal pattern (fig. 2.2) both of them indicating that the system belongs to the class under

consideration.

$$\begin{matrix}
 & y_1 & y_2 & \dots & y_n & z^1_1 & z^1_2 & \dots & z^1_{m_1} \dots & z^p_1 & z^p_2 & \dots & z^p_{m_p} \\
 \begin{matrix} R_1 \\ R_2 \\ \vdots \\ R_r \end{matrix} & \left( \begin{array}{cccccccccccc}
 1 & 0 & \dots & 1 & 1 & 0 & \dots & 0 & \dots & 1 & 0 & \dots & 0 \\
 1 & 1 & \dots & 0 & 0 & 1 & \dots & 1 & \dots & 1 & 0 & \dots & 1 \\
 \vdots & \vdots & & \vdots & \vdots & \vdots & & \vdots & & \vdots & \vdots & & \vdots \\
 0 & 1 & \dots & 1 & 0 & 0 & \dots & 1 & \dots & 1 & 1 & \dots & 1
 \end{array} \right)
 \end{matrix}$$

Fig 1: Constraint Matrix in a general case

2.1 Cascade pattern

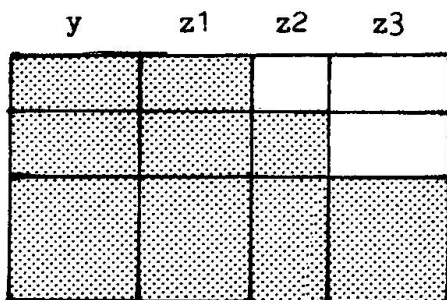

2.2 Quasi block diagonal pattern

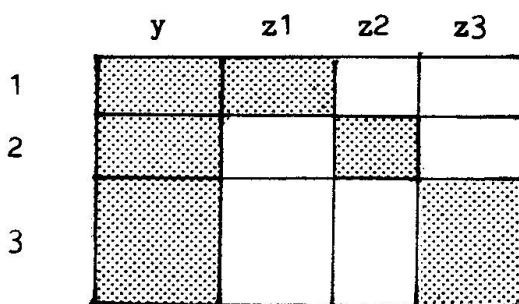

Fig. 2: Significant patterns of the constraint matrix' occupation

Different optimization methods may be used to solve such problems in different cases. If the constraint matrix shows a quasi-block-diagonal pattern a two level optimization method may be applied ([2], see fig. 3). This method is based at the separation of coordinating variables from the local ones . The values of the variables are then optimized at two levels: those of the coordinating variables at the upper one and those of the local variables at the lower one. A detailed description of this method, illustrated by a case study, is given in [3].

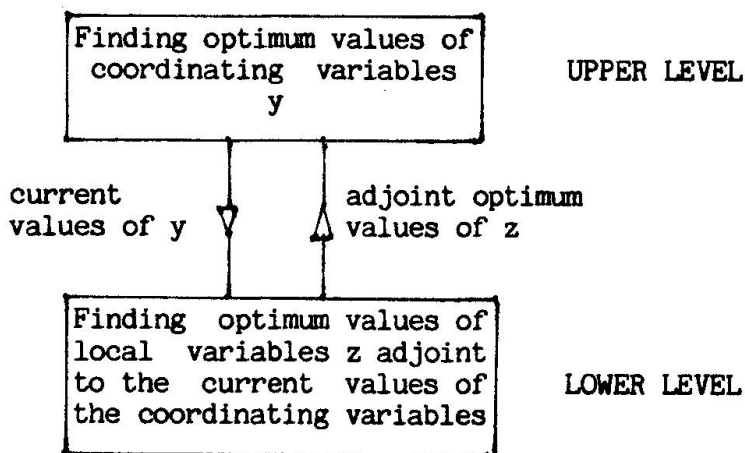

Fig. 3: Two - level optimization

In the case of a system with a cascade patterned constraint matrix one cannot optimize the subsystems parallelly and independently at the lower level. A pragmatic procedure for optimizing such systems is presented below. It delivers an upper and a lower limit of the whole system's optimum.



## 2. A PRAGMATIC APPROACH TO OPTIMIZE SYSTEMS WITH A CASCADE PATTERNED CONSTRAINT MATRIX

If the amount of the decisive effect which at least one of the subsystems emits significantly depends upon the values of this subsystem's decision variables, then it will not be possible to arrange the rows of the constraint matrix such that a quasi block diagonal pattern occurs. With structures e.g. this happens if the variations in the elements' own weight caused by modifications of their size during the optimization cannot be neglected.

The cascade pattern indicates that the subsystems cannot, as this is possible in the case of the quasi block diagonal pattern, be optimized independently from each other, once a set of values of the coordinating variables is chosen. It then might be possible that less 'optimal' subsystems at the beginning of the effect's flow sequence cause a better optimization of the whole system. In case of reinforced concrete framed building structures for example it may happen that to the cheapest construction belong the lightest permissible floor slabs which - depending on the reinforcement-concrete-price-ratio - must not be the cheapest ones in any case.

Generally: If (1) the contribution of a subsystem to the objective function's value is decreased by 'forewarding' an increasing amount of the decisive effect and if (2) decreasing the contribution of that subsystem to the decisive effect causes decreasing its contribution to the objective function's value as well, (a maximum value of the objective function assumed to be optimum) then the following process yields an upper and a lower limit of the optimum:

At the lower level, that means for each chosen set of coordinating variables' values, the subsystems will be handled sequentially according to the flow of the decisive effect. Each subsystem will be optimized twice:

- Once charged by that amount of effect which is emitted by the sum of suboptima of all the subsystems 'upstream' and
- a second time charged by the minimum possible emission of effect from each of the subsystems 'upstream'.

The sum of objective function's components obtained by the second procedure will - according to the presuppositions - be higher than the respective sum of the first one. But the subsystems belonging to that sequence are not compatible to one another, since each of them would feed a higher amount of effect to the flow than this is assumed when dimensioning the following ones. Thus we get an upper limit of the objective function's value which is higher than the strict optimum one really is. The latter will lie between both sums. Only if the suboptima of all subsystems emit the minimum amount effect as well, then the first procedure yields the strict optimum immediately.

The proposed process does not only yield the limits between which the strict optimum is to be found, and therewith the span of reachable optimization profit, but also the contribution of each subsystem to the objective functions's value. Thus the designing engineer will be enabled to decide whether further optimization efforts shall be invested and if so, to which of the subsystems.

Some details of the proposed process are going to be illustrated by the following case study.



### 3. A CASE STUDY: DIMENSIONING A SUPERMARKET BUILDING'S STRUCTURE OPTIMALLY

The roof structure of a single floor supermarket building shall be dimensioned optimally. The building with a plan area of 80 x 80 meters is sketched in fig. 4. Its structure shall be assembled by a few types or prefabricated reinforced concrete elements: ribbed floor slabs, T-beams and columns. The column's reinforced concrete footings shall be cast in situ. Details of the elements are given in fig. 5.

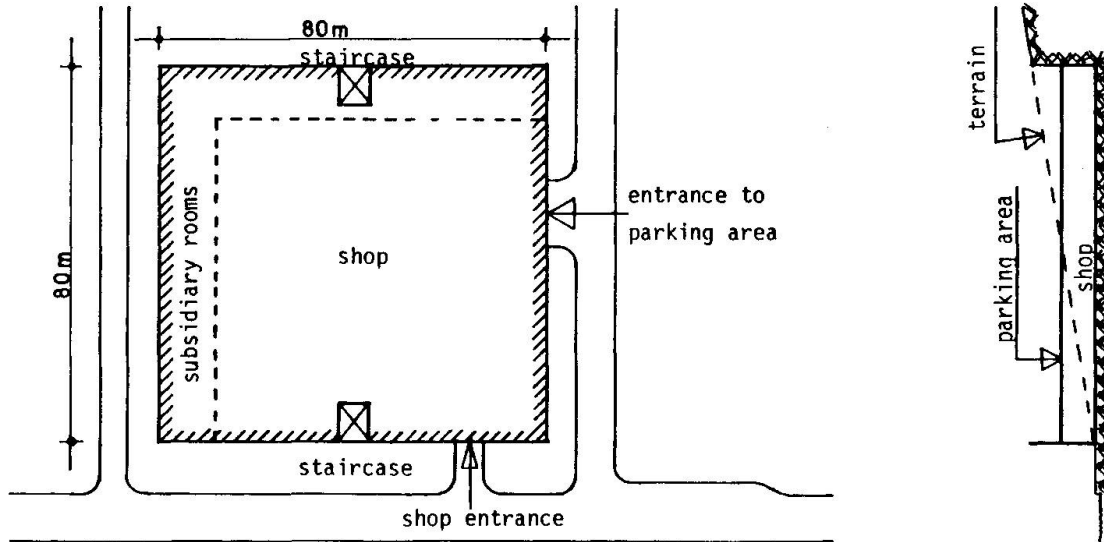

Fig. 4: Lay-out sketch of the supermarket building

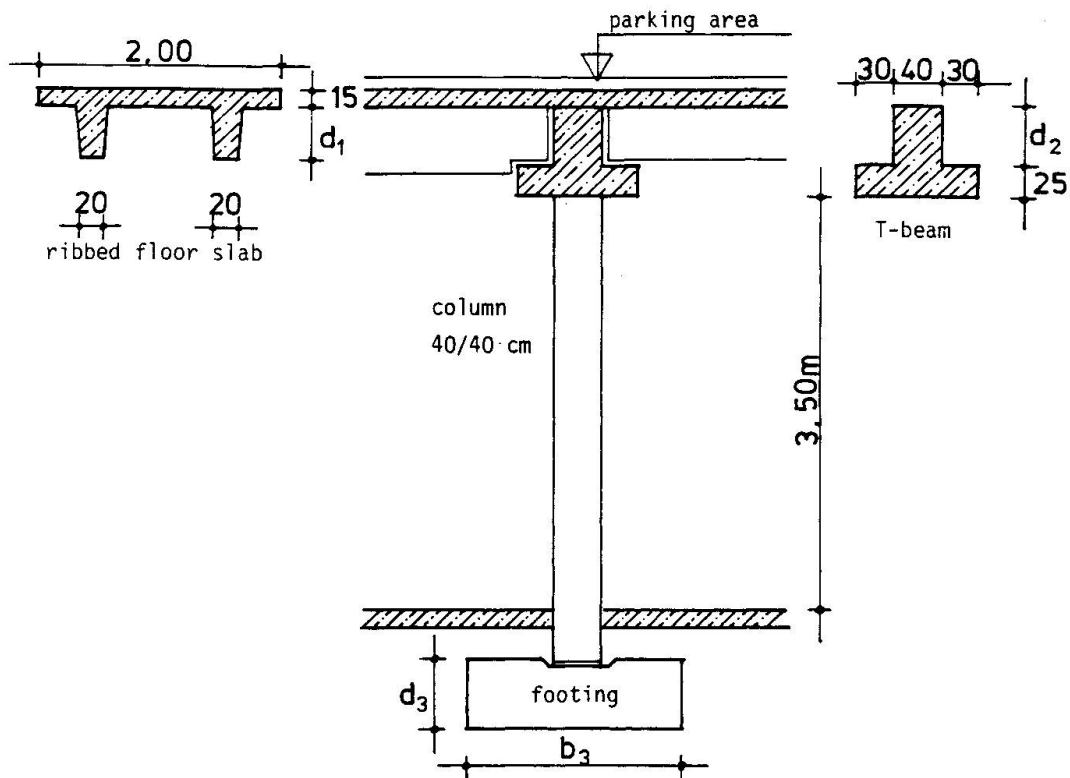

Fig. 5: Details of the supermarket building's structure



The function of this structural system is to carry the live loads acting at the building's roof, which in this special case originates not only from wind and snow but mainly from traffic load, since the roof plane shall be used as a parking area. Load is the deciding effect flowing through the system. Since the structure may be modelled to be a statically determinate one the system falls into the class under consideration. That is because the effect which the elements have to 'forward' through the system flows sequentially (without feedback) from one element to the next, namely from the floor slabs via the beams, the columns and the footings to the soil.

Some of the structural elements' dimensions are given by the forms used in the prefabrication. There remain therefore only a few design variables the values of which may be altered for the purpose of dimensioning the structure optimally. These are (cf. fig. 5):

d1 : height of the floor slab's rib (1st subsystem)  
 d2 : web height of the T-beam (2nd " " )  
 d3 : thickness of the column's footing (3rd " " )  
 b3 : width of the (square) footing. (3rd " " )

The column does not appear as an independent subsystem since its external dimensions are fixed totally in advance. In addition to these subsystem variables there are coordinating variables too. These are the distances between the columns in both directions,  $x$  and  $y$ .  $x$  is measured in the direction of the ribbed slab's span,  $y$  is the span of the T-beams. Both of them may not be altered continuously because of some restrictions from the shelves in which the goods are presented. This is to be seen from fig. 6.

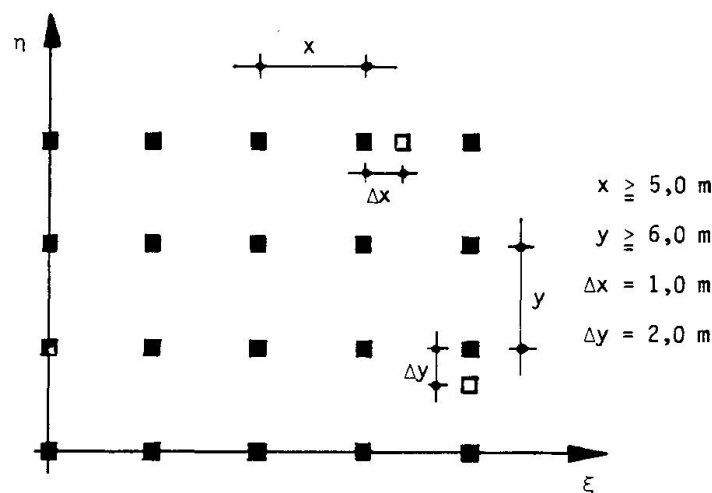

Fig. 6: Structural grid of the ground floor

The objective function is defined under the producer's point of view. He wants to reduce the production and erection costs and is not interested in the building's maintenance costs. That function is a nonlinear one and of the additive type, depending on all the coordinating and the subsystem variables:

$$\min (\bar{f}_1(x,d1) + \bar{f}_2(x,y,d2) + \bar{f}_3(x,y,d3,b3))$$

$x,y,d1,d2,d3,b3$



The third component of this function maps the casting costs of the footing to the objective function. These costs increase monotonously with the footing's width  $b_3$ . Therefore the optimum structure always contains the footing with the lowest permissible value of  $b_3$ , which depends, given all the other variables' values, on the permissible pressure in the foundation bed only. Hence it has not to be considered as a (free) decision variable.

The optimization model of the building's structural system contains three subsystems, each of them having just one decision variable (see below in brackets)

1. Floor slab (d1)
2. Beam and column (d2)
3. Footing (d3),

two coordinating variables

$x$  and  $y$  (grid dimensions),

the objective function

$$\min ( f_1(x,d_1) + f_2(x,a,d_2) + f_3(x,y,d_3) )$$

$x, y, d_1, d_2, d_3$

and the constraints

$$\begin{aligned} g_1(x,d_1) &\geq \theta_1 \\ g_2(x,y,d_1,d_2) &\geq \theta_2 \\ g_3(x,y,d_1,d_2,d_3) &\geq \theta_3. \end{aligned}$$

$g_1$ ,  $g_2$  and  $g_3$  are sets of constraint functions for the subsystems 1, 2 and 3 respective,  $\theta_1$ ,  $\theta_2$  and  $\theta_3$  zero-vectors of the respective dimensions.

The constraints are determined by demands of structural safety, compatibility of the subsystems and exploitation of the reinforcement. They are nonlinear functions in general. Neither the latter nor the components of the objective function can be outlined here.

The cascade pattern of this problem's constraint matrix is shown in fig. 7.

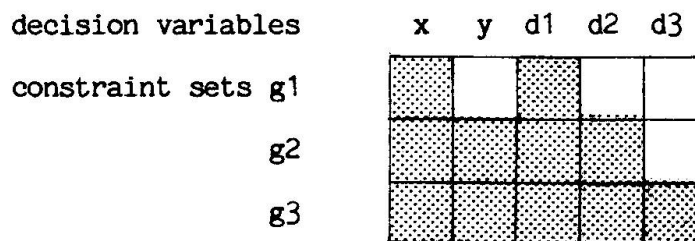

Fig. 7: Pattern of the constraint matrix

Searching for the optimum dimensions of the structure, one has to vary the values of the coordinating variables and for each pair of them to optimize the subsystems' dimensions. Increasing values of these variables cause increasing amount of the deciding effect (i.e. the load) and at the same time increasing costs. Therefore it has to be tested, whether lighter ribbed slabs than the cheapest ones will cause lower total costs because of savings with the beams, columns and footings.





It is not possible to show the optimization process totally, because a lot of steps have to be gone at the upper level. For the optimal pair of coordinating variables only the results of both procedures, optimizing the subsystems in the sequence of load-flow, first considering the own weight of the cost-minimal preceding subsystems and second considering the own weight of the weight-minimal ones, shall be presented. All branches of the tree in fig. 8, which are directed to the right represent results from a cost-minimizing step, those directed to the left the results from a weight-minimizing one.

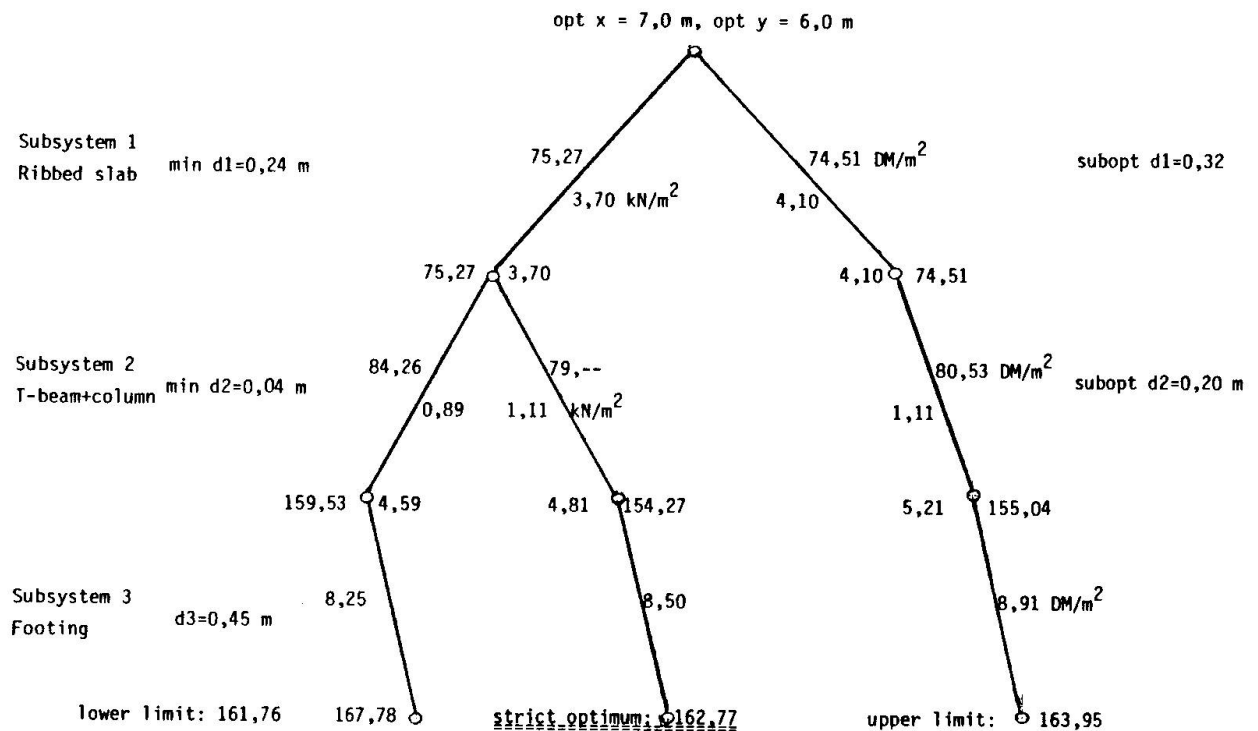

Fig. 8: Establishing upper and lower limit of optimum at the lower optimization level by a binary tree

These result have been obtained inserting realistic figures for wages, materials' and equipment's prices of summer 1981 in the Federal Republic of Germany, in practically usefull costing algorithm. The constraints have been derived from the German building codes. Fig. 8 should be interpreted as follows:

The optimal (= cost minimal) pair of grid dimensions (= coordinating variables) is x (= ribbed slab's span) = 7.0 m, y (= T-beam's span) = 6.0 m. At this grid the cost minimal ribbed plate has a rib height d1=0.32 m, an own weight of 4.1 kN/m<sup>2</sup> and costs 74.51 DM/m<sup>2</sup>. The weight minimal slab on the other hand has a rib height d1=0.24 m, weighs 3.7 kN/m<sup>2</sup> and costs 75.27 DM/m<sup>2</sup>. Then pursuing the right branch: The cheapest T-beam which can take the load of the cheapest slab costs 80.53 DM per m<sup>2</sup> plan area and increases the own weight of the structure by 1.11 kN/m<sup>2</sup>. In this case a footing is needed which brings additional



costs of 8.91 DM/m<sup>2</sup>. Thus the sequence of cost minimal elements, mapped to the right branch of the tree, costs 163.96 DM/m<sup>2</sup> totally. Now pursuing the left branch: The lightest T-beam to take the lightest slab's own weight ( in addition to traffic and roof plane dead load of course ) costs 84.26 DM/m<sup>2</sup> and weighs 0.89 kN/m<sup>2</sup> additionally, such that a cost minimal footing with a price of 8.25 DM/m<sup>2</sup> will be needed. (The weight minimal footing is of course out of interest). Hence the sequence of the lightest elements, mapped to the leftmost branch, brings total costs of 167.78 DM per m<sup>2</sup> plan area.

If we chose the cheapest T-beam to carry the lightest slab then this one costs 79.- DM/m<sup>2</sup> and weighs 1.11 kN/m<sup>2</sup>. Now we may establish the lower cost limit - which is adequate to the upper limit of a positive objective function - by adding the cost of the cheapest slab, of the cheapest beam to carry the lightest slab and of the cheapest footing to carry the lightest slab and beam. This sum does not contain the costs of a permissible structure, but shows, whether there could be a solution which takes lower costs than the sequence of the cost minimal elements. Since this limiting sum is 161,76 DM/m<sup>2</sup>, we may expect, that we could find the absolute cost minimal structure at one of our tree's middle branches.

This one is easy to find in our simple example. We only need to take the footing beyond the cheapest beam bearing the lightest slab. Its cost minimum is 8.50 DM/m<sup>2</sup> and then we have the strict optimum total costs of 162,77 DM/m<sup>2</sup>.

#### 4. CONCLUDING REMARKS

The example presented above shows in a few figures the course of the pragmatic approach to optimize building systems which are members of the class under consideration. Though the results do not seem to be very impressive it could be proven, that systems with a cascade patterned constraint matrix cannot simply be optimized by following the course of suboptimal subsystems. If we had taken a multi story building instead of a single floor one and/or an other ratio of wages and material prices, such as this could appear in developing countries, then we should have got larger margins of optimization profit. We preferred the presented case as well since we just wanted to have the example as realistic and as simple as possible.

So far we did not mention the use of computers. But it seems very clear that a two level optimization process as described here can only be realized in an interactive mode of data processing. If the system consists of many subsystems and if there are many coordinating variables then the designing engineer needs a tool to just control the different types of steadily repeated steps. At the upper level he has to search for the best direction in the coordinating variables' space, at the lower one to do the same with the decision variables' space of each subsystem and afterward to investigate the binary tree of subsystem's combinations. This has to be done repeatedly and would not be possible without using a computer.

As was outlined in [4] this is one of the computer aided design tools helping the designer to select the most useful solution of his problem. It would be possible to bring this type of tools together in a subsystem of an information system which provides all the instruments the designer needs in the course of his work from searching for appropriate solutions to preparing the construction documents.



## 5. ACKNOWLEDGEMENTS

This paper presents a part of the results which we obtained during a period of intensive research co-operation which was made possible by a grant of the Deutsche Forschungsgemeinschaft. We want to thank for this support and we hope that we shall be able to continue the work in this field. For his proposals concerning the example, his advices and his active co-operation during the preparation of the case study we have to thank Dipl.Ing. Robert Petzelies, whose experience in the prefabrication helped us to set up a realistic optimization model of this structure.

## 6. REFERENCES

- [1] LESNIAK, Z.K. and SCHWARZ, H.: Optimization of building systems. To be published in CAD - Computer Aided Design, July 1982
- [2] FINDEISEN, W., SZYMANOWSKI, J. and WIERZBICKI, A.: Teoria i metody obliczeniowe optymalizacji. PWN, Warszawa, 1977
- [3] LESNIAK, Z.K.: Optimization of Structures using Decomposition. IABSE Colloquium, Bergamo, August 1978, Proceedings
- [4] SCHWARZ, H. and STEIGER, F.: Evaluation Methods for Design Alternatives. Contribution to the IABSE Colloquium on "Informatics in Structural Engineering", Bergamo 1982