

Roof panel to purlin connection: rotational restraint factor

Autor(en): **LaBoube, Roger A.**

Objektyp: **Article**

Zeitschrift: **IABSE reports = Rapports AIPC = IVBH Berichte**

Band (Jahr): **49 (1986)**

PDF erstellt am: **23.07.2024**

Persistenter Link: <https://doi.org/10.5169/seals-38296>

Nutzungsbedingungen

Die ETH-Bibliothek ist Anbieterin der digitalisierten Zeitschriften. Sie besitzt keine Urheberrechte an den Inhalten der Zeitschriften. Die Rechte liegen in der Regel bei den Herausgebern.

Die auf der Plattform e-periodica veröffentlichten Dokumente stehen für nicht-kommerzielle Zwecke in Lehre und Forschung sowie für die private Nutzung frei zur Verfügung. Einzelne Dateien oder Ausdrucke aus diesem Angebot können zusammen mit diesen Nutzungsbedingungen und den korrekten Herkunftsbezeichnungen weitergegeben werden.

Das Veröffentlichen von Bildern in Print- und Online-Publikationen ist nur mit vorheriger Genehmigung der Rechteinhaber erlaubt. Die systematische Speicherung von Teilen des elektronischen Angebots auf anderen Servern bedarf ebenfalls des schriftlichen Einverständnisses der Rechteinhaber.

Haftungsausschluss

Alle Angaben erfolgen ohne Gewähr für Vollständigkeit oder Richtigkeit. Es wird keine Haftung übernommen für Schäden durch die Verwendung von Informationen aus diesem Online-Angebot oder durch das Fehlen von Informationen. Dies gilt auch für Inhalte Dritter, die über dieses Angebot zugänglich sind.

Roof Panel to Purlin Connection: Rotational Restraint Factor

Assemblage panne-panneau de toiture: facteur de résistance à la rotation

Dachblech-Pfetten-Verbindung: Drehwiderstandsfaktor

Roger A. LaBOUBE

Senior Structural Engineer
Amer. Iron and Steel Inst.
Washington, DC, USA

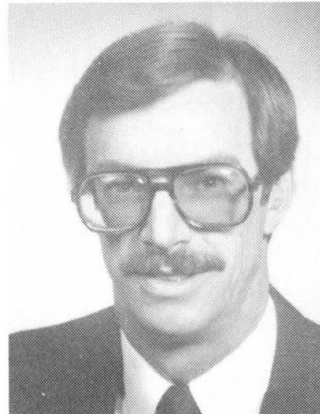

Roger LaBoube, born 1948, received his Ph.D. in Civil Engineering at the University of Missouri-Rolla, Rolla, MO. For five years he was involved in research and development at Butler Mfg. Co. where Dr. LaBoube's studies have focused on the behavior of coldformed steel members.

SUMMARY

The load carrying capacity of a metal building roof system subjected to wind uplift is significantly influenced by the rotational restraint or stiffness provided to the purlin by the connection of the roof panel to the purlin. This rotational restraint factor is commonly referred to as the «F» factor. A test program was executed to experimentally determine the «F» value for the variation in parameters that may have an influence on the rotational restraint. This paper summarizes the findings of numerous «F» tests and presents an empirical equation to estimate the «F» factor.

RÉSUMÉ

La capacité portante d'une toiture métallique d'un bâtiment soumise à la succion du vent est considérablement influencée par la résistance à la rotation fournie aux pannes par leurs assemblages aux panneaux de toiture. Le facteur de résistance à la rotation est communément appelé facteur «F». Un programme expérimental a été exécuté pour déterminer les valeurs de «F» en fonction des paramètres qui pourraient influencer la résistance à la rotation. Le présent article résume les résultats de plusieurs essais, et présente une équation empirique pour estimer le facteur «F».

ZUSAMMENFASSUNG

Die zulässige Traglast von blechverkleideten Stahldächern unter negativen Windlasten (Sog) wird wesentlich vom Drehwiderstandsfaktor oder der Drehsteifigkeit der Dachblech-Pfetten-Verbindung beeinflusst. Dieser Drehwiderstandsfaktor ist allgemein als F-Faktor bekannt. Das beschriebene Versuchsprogramm führte zu einer Bestimmung der F-Faktoren als Funktion von verschiedenen Einflussgrößen. Der Beitrag beschreibt die Resultate zahlreicher Versuche und stellt ein empirisches Verfahren zur Abschätzung des F-Faktors vor.



INTRODUCTION

The load carrying capacity of a metal building roof system, subjected to wind uplift, is significantly influenced by the rotational restraint or stiffness provided to the purlin by the connection of the roof panel to the purlin. This rotational restraint factor is commonly referred to as the "F" factor.

In the United States, the "F" value is experimentally determined using a test procedure developed by Haussler and Pabers [1]. This report summarizes the findings of numerous "F" tests and presents an empirical equation to estimate the "F" factor.

Test Fixture

A test fixture, Figure 1, was fabricated that complied with the guidelines prescribed in Reference 1. A complete description of this setup is given in Reference 2.

Parametric Study

The rotational stiffness inherent in a roof system is a function of the geometry of the individual components and the method of attachment of the components. Therefore, the significant parameters in a metal building roof system appeared to be: (1) Purlin depth and thickness, (2) Roof sheet depth and thickness, (3) Insulation thickness, (4) Fastener type and (5) Fastener location.

A series of tests were conducted to investigate the change in the "F" factor with variations in the above parameters. The "F" factor is defined by the slope of the load-deflection curve.

Purlin Depth and Thickness

Assuming rotational restraint provided by the roof sheet and its attachment to the purlin, the web and loaded flange (Figure 1) act as a cantilevered member. Therefore, the purlin depth and thickness were identified as important parameters influencing the "F" factor.

Figure 2 presents a typical load-deflection for a 203 mm deep Z-section. The figure clearly shows that the material thickness has a very significant affect on the stiffness of the roof system. However, the member depth imparts a lesser influence on the rotational characteristics. See Figure 3.

Roof Sheet Depth and Thickness

A representative roof sheet used by the metal building industry, in the United States, is 914 mm wide with major corrugations of 25 mm to 38 mm in depth. For this range of depths, the "F" factor is not affected - see Figure 4.

Unlike the roof sheet depth, the sheet thickness does have some impact on the numerical value for the "F" factor. Figure 5 graphically represents the affect of varying sheet thickness from .50 mm (26 ga.) to .65 mm (24 ga.). This range in sheet thickness represents the typical metal building industry standard.

Insulation Thickness

The presence of insulation, between the purlin flange and roof sheet, and its affect on the rotational stiffness was investigated. Specimens were tested which had 38 mm, 76 mm and 152 mm blanket insulation. The load-deflection characteristics of these specimens are compared to a specimen having no insulation (see Figure 6). As indicated by the plotted data, the insulation thickness had only a slight affect on the stiffness. This may be due to the fact that all of the blanket thicknesses studied are compressed to approximately an equal thickness between the purlin and roof sheet.

Fastener Type and Location

Metal building roof systems typically employ either self-tapping or self-drilling sheet metal screws. Figure 7 graphically shows the behavior of comparable self-tapping and self-drilling screws.

The enhanced performance of the self-tapping screw may be attributed to either a pre-punched hole versus a drilled hole, or better control over the location of the fastener in the purlin flange.

As indicated by Figure 8, the location of the screw in the flange of a Z-section is very critical. The specimens in question consisted of 203 mm deep Z-sections attached to a 26 ga. roof sheet by using a No. 14 self-tapping screw.

Empirical Equation

Results of the parametric study indicated that the more significant variables affecting the rotational stiffness are the purlin thickness, sheet thickness and fastener type and location. Therefore, tests were conducted to evaluate the "F" factor for typical Butler Manufacturing Company roof systems.

This test program was executed using Z-sections having a thickness of either 1.55 mm or 3.05 mm. The roof panels were either .65 mm or .50 mm steel or .66 mm aluminum sheets. Screw fasteners were of the self-drilling and self-tapping type. A self-clinching rivet was also employed. All fasteners were located at the center of the flange.

Figures 9 and 10 graphically depict the load-deflection characteristics for the various test specimens. Based upon a regression analysis, the "F" factor represented by Equation 1 is 2.39 pounds per inch of member length per inch of horizontal deflection (10.63 N/mm/mm), and the corresponding factor for Equation 2 is 3.60 lb/in/in (16.01 N/mm/mm).

A linear variation, with thickness, was assumed and Equation 3 was developed for the stiffness, or "F" factor, for all values of purlin thickness between 1.55 mm and 3.05 mm,

$$"F" = 20.41 (t - .061) + 2.3 \quad (3)$$

Equation 3 yields a value of "F" in units of lb/in/in where the purlin thickness t , is in units of inches.

Conclusion

Based upon the test results discussed herein, the numerical value of the rotational stiffness or "F" factor was shown to be primarily dependent upon the purlin thickness, roof sheet thickness and fastener type and location within the flange width. An equation was presented for computing the "F" factor for a typical metal building roof system.

References

1. Haussler, R. W., and Pabers, R. F., Connection Strength in Thin Metal Roof Structures, Proceedings, Second International Specialty Conference on Cold-Formed Steel Structures, University of MO-Rolla, October 1973.
2. Observer's Report, Determination of Rotational Restraint Factor "F" for Panel to Purlin Rigidity, MRI Project No. 7105-G, Midwest Research Institute February 1981.

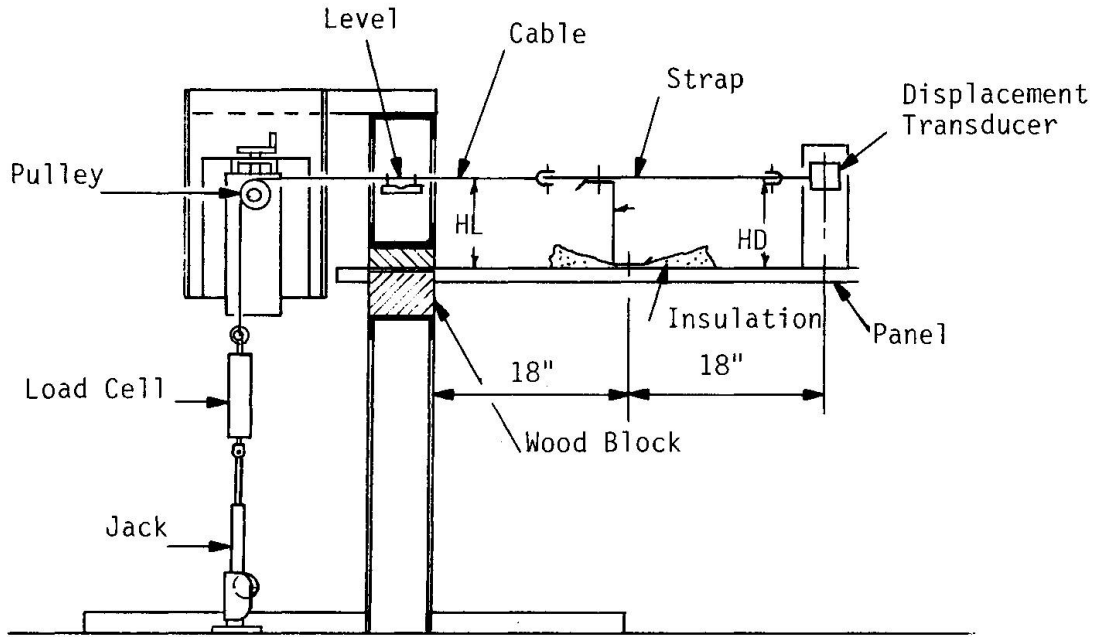

Fig. 1 - Test Apparatus

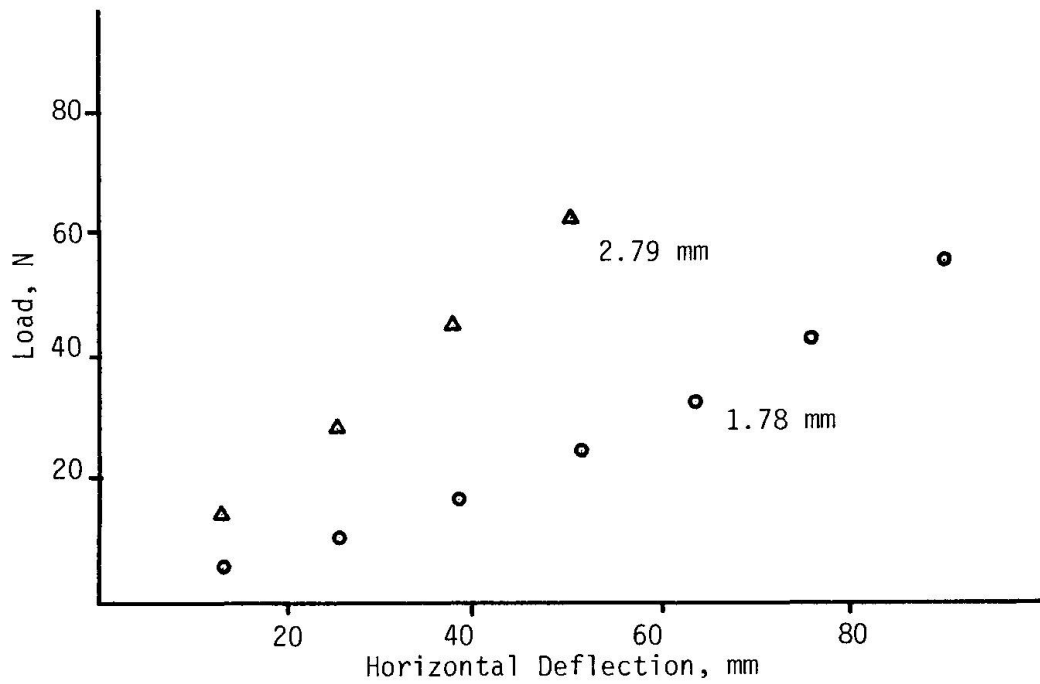

Fig. 2 - Affect of Purlin Thickness

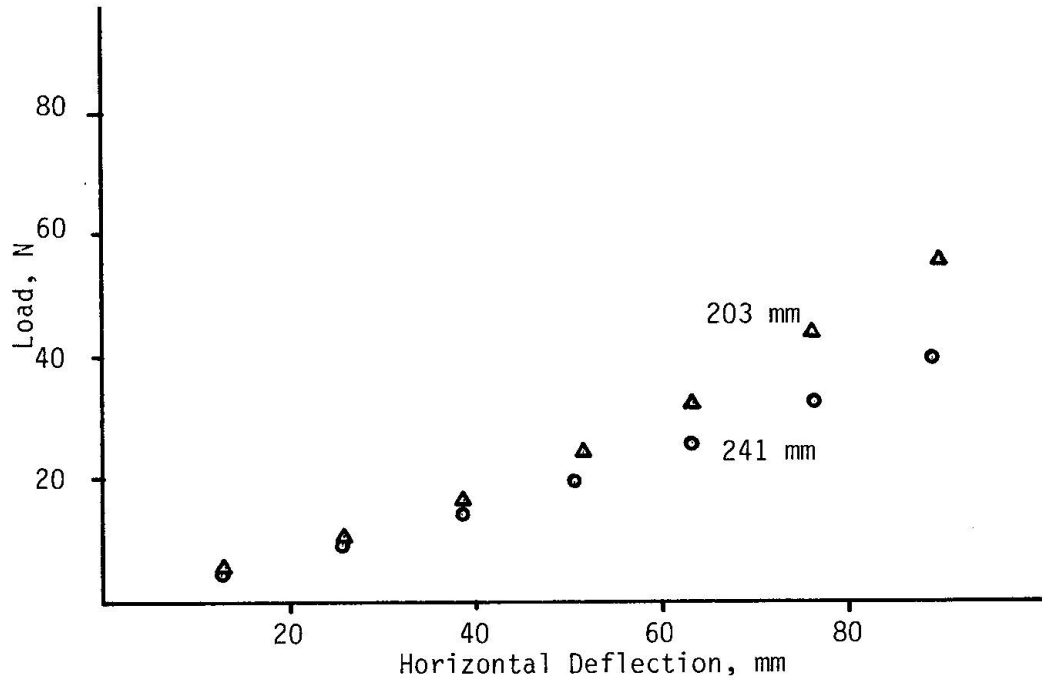

Fig. 3 - Affect of Purlin Depth

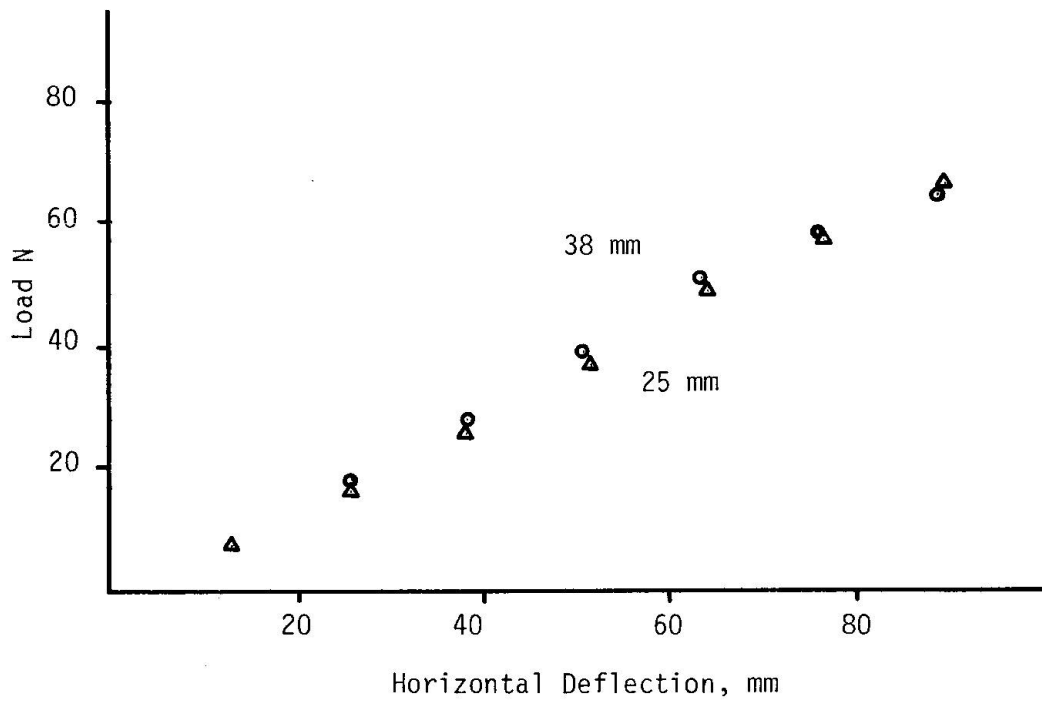

Fig. 4 - Affect of Panel Depth

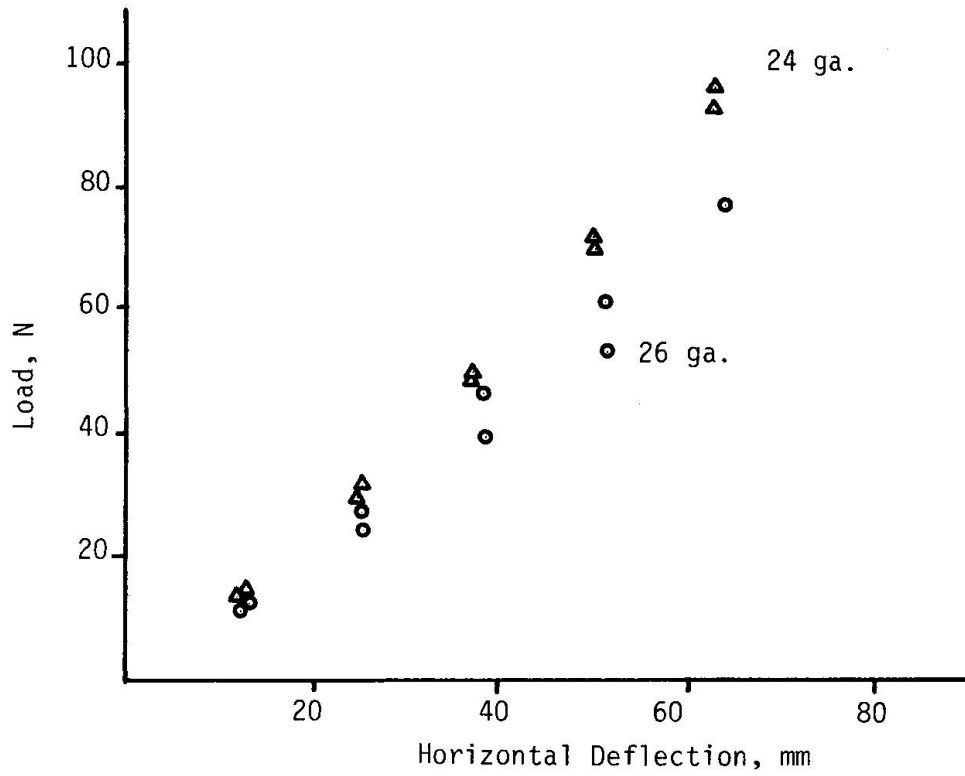

Fig. 5 - Panel Thickness Affect

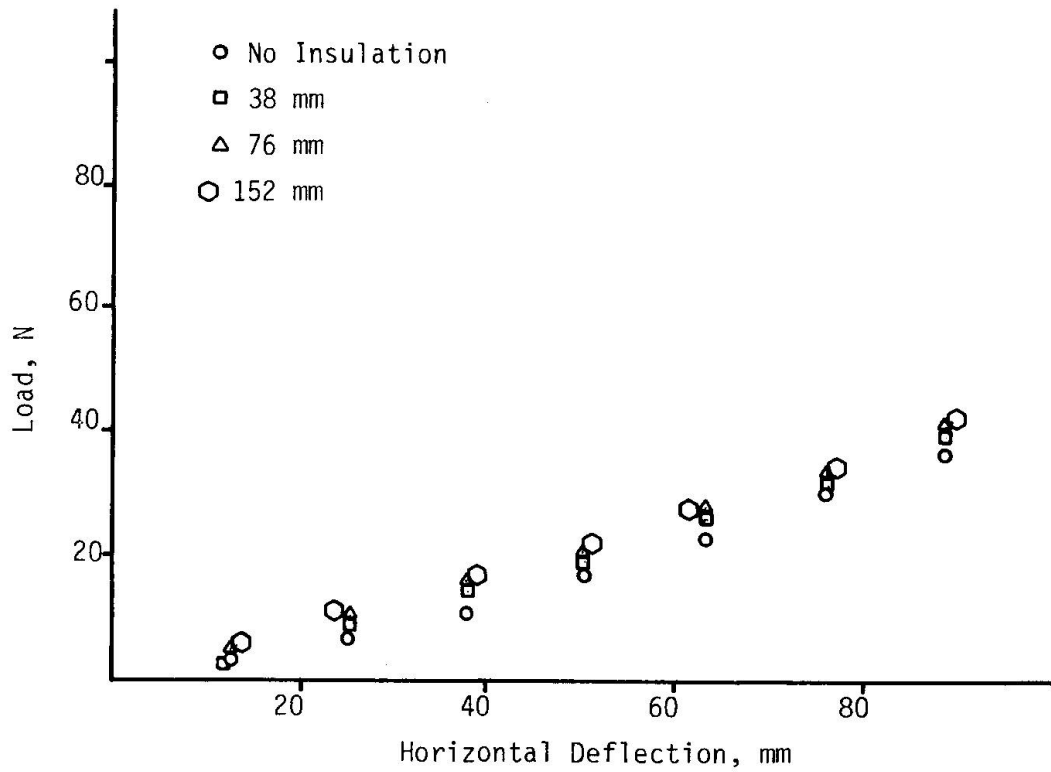

Fig. 6 - Affect of Insulation Thickness

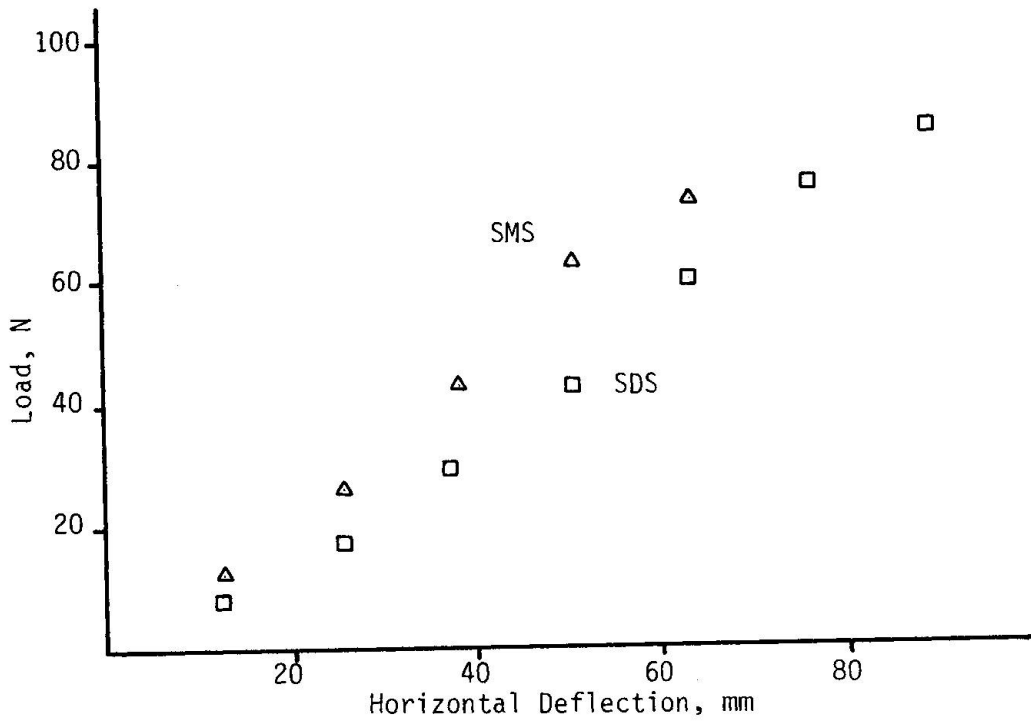

Fig. 7 - Affect of Fastener Type

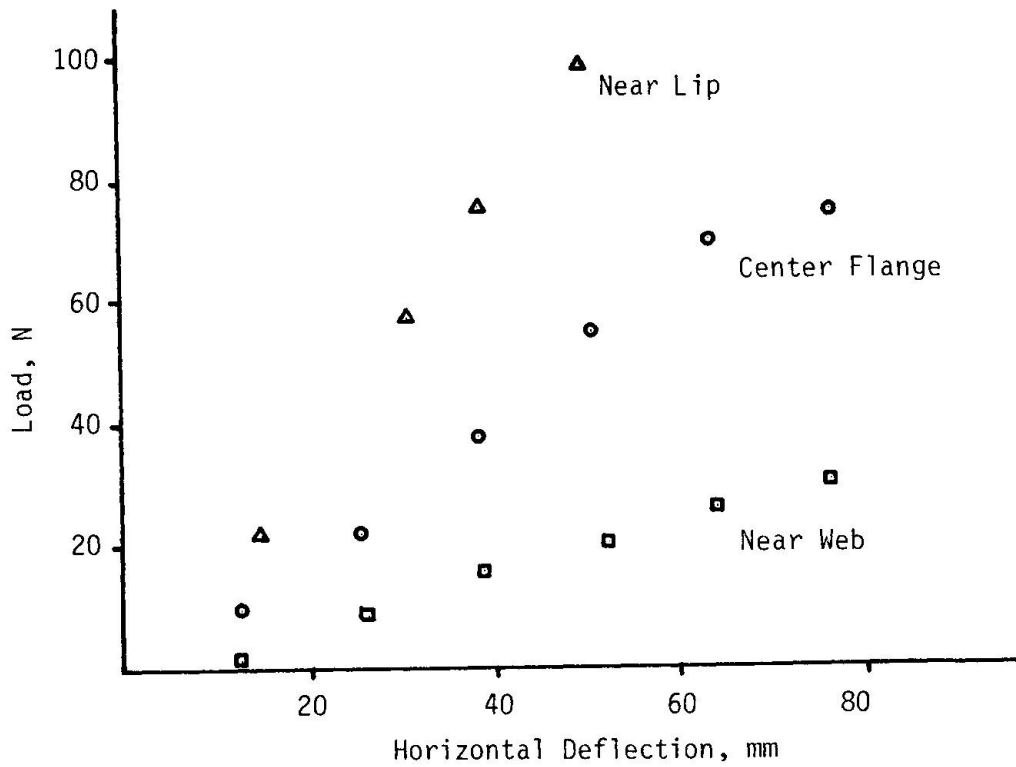

Fig. 8 - Affect of Fastener Location

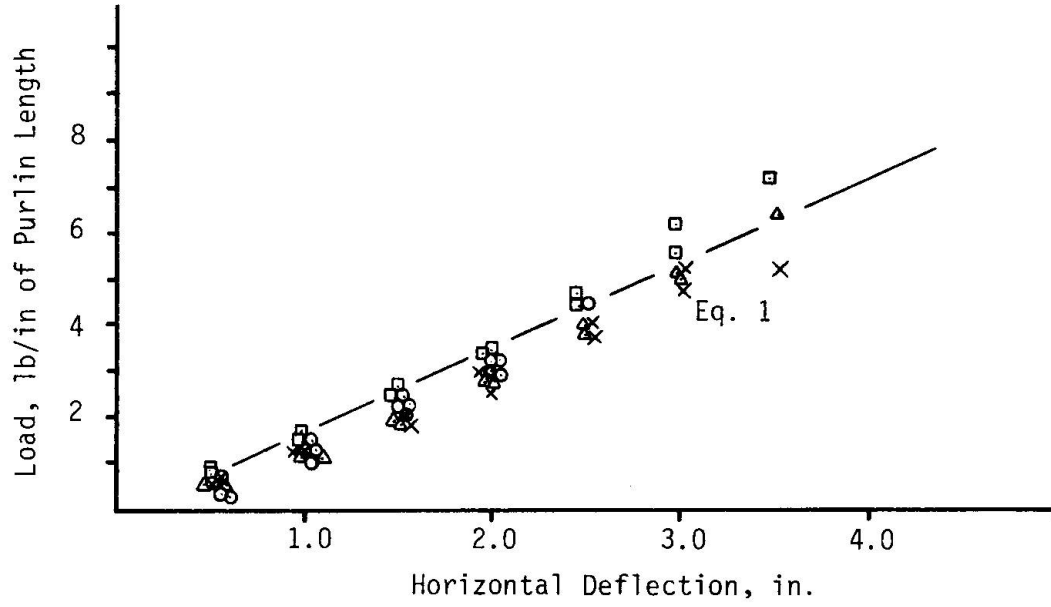

Fig. 9 - "F" for Typical Roof Systems Having .061" Purlin

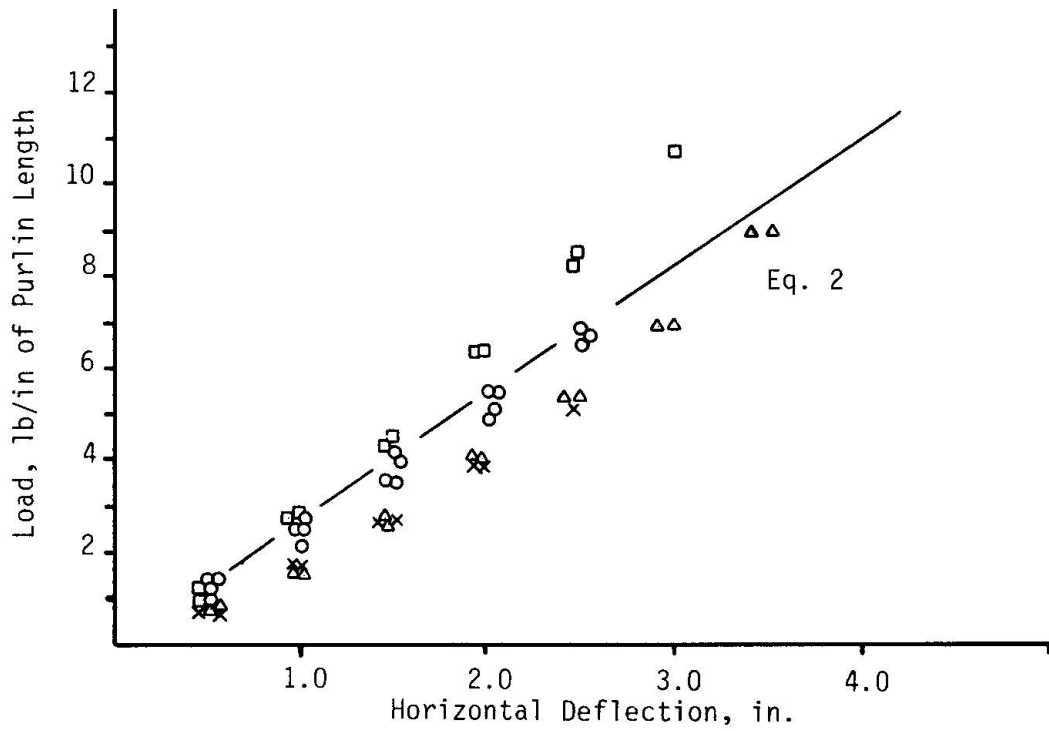

Fig. 10 - "F" for Typical Roof Systems Having .120" Purlin