

Theme 4: Building physics in light-gauge metal construction

Objektyp: **Group**

Zeitschrift: **IABSE reports = Rapports AIPC = IVBH Berichte**

Band (Jahr): **49 (1986)**

PDF erstellt am: **23.07.2024**

Nutzungsbedingungen

Die ETH-Bibliothek ist Anbieterin der digitalisierten Zeitschriften. Sie besitzt keine Urheberrechte an den Inhalten der Zeitschriften. Die Rechte liegen in der Regel bei den Herausgebern.

Die auf der Plattform e-periodica veröffentlichten Dokumente stehen für nicht-kommerzielle Zwecke in Lehre und Forschung sowie für die private Nutzung frei zur Verfügung. Einzelne Dateien oder Ausdrucke aus diesem Angebot können zusammen mit diesen Nutzungsbedingungen und den korrekten Herkunftsbezeichnungen weitergegeben werden.

Das Veröffentlichen von Bildern in Print- und Online-Publikationen ist nur mit vorheriger Genehmigung der Rechteinhaber erlaubt. Die systematische Speicherung von Teilen des elektronischen Angebots auf anderen Servern bedarf ebenfalls des schriftlichen Einverständnisses der Rechteinhaber.

Haftungsausschluss

Alle Angaben erfolgen ohne Gewähr für Vollständigkeit oder Richtigkeit. Es wird keine Haftung übernommen für Schäden durch die Verwendung von Informationen aus diesem Online-Angebot oder durch das Fehlen von Informationen. Dies gilt auch für Inhalte Dritter, die über dieses Angebot zugänglich sind.



THEME 4

Building Physics in Light-Gauge Metal Construction

Chairmen:

K. Gertis, FRG, and I. Höglund, Sweden

Leere Seite
Blank page
Page vide

Building Physics for Light-Gauge Construction

Physique du bâtiment pour la construction légère

Bauphysik für den Leichtbau

Claes G. BANKVALL

Assoc. Prof.
Swedish Natl. Testing Inst.
Borås, Sweden



Claes G. Bankvall, born 1942, M.Sc. in engineering 1970, doctor of engineering 1973, Lund Institute of Technology, Ass. Prof. in Building Physics. Research in heat transfer in building structures and thermal insulation and energy and conservation. Since 1974 at the Swedish National Testing Institute, Borås.

SUMMARY

This presentation introduces the main topics within the field of Building Physics. The transport of heat, moisture and air in the building envelope and its performance is discussed. The basic considerations for a proper Building Physics design are pointed out. Reference is made to light-gauge metal construction.

RÉSUMÉ

Cette contribution consiste en une brève introduction aux principaux sujets traités dans le domaine de la physique du bâtiment. Il y est question du transfert de chaleur, d'humidité et d'air dans l'enveloppe d'un bâtiment ainsi que des considérations de base pour une conception adéquate relatives à ces sujets. Des exemples propres à la construction légère en acier y sont mentionnés.

ZUSAMMENFASSUNG

Dieser Beitrag gibt eine Einführung in die Hauptgebiete der Bauphysik. Der Transport von Wärme, Feuchtigkeit und Luft in den Bauteilen und die Funktion der Aussenkonstruktion werden besprochen. Grundsätzliche Überlegungen für einen guten bauphysikalischen Entwurf werden aufgezeigt und Beispiele von Metall-Leichtbaukonstruktionen gegeben.



Introduction

In Building Physics primary areas deal with the transport of heat, moisture and air in and around a building. Deficiencies in these areas can explain a number of the building damages known in many countries. Civil engineers often make advanced static calculations but treat the basic aspects of building physics in an inadequate manner.

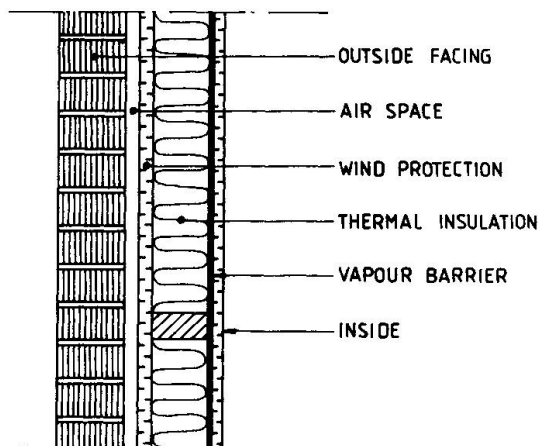

The building envelope is primarily intended to give such conditions that a good indoor climate can be established, both for the use of the building and for the building materials and their durability. The requirements on the building envelope are clearly illustrated by the requirements on the different parts in a wall or a roof structure.

In a multi-layer structure the different parts have their specialized functions. The normal stud wall is an example of this (Figure 1).

Figure 1

1. The outside layer protects against rain and direct wind.
2. The air space gives a possibility of ventilating or draining out moisture.
3. A wind protection layer protects the thermal insulation from air movements from the outside.
4. The thermal insulation gives the structure its main thermal resistance.
5. The vapour barrier protects against moisture transport through the wall and also gives it its main air tightness.
6. On the inside of the wall a board is mounted to give the surface its required performance. This will generally increase the air tightness of the wall.

In a roof structure the corresponding functions will be found. In this case the roof covering will protect against rain and direct wind.

The above described situation is also true for a light-gauge construction. With this in mind the well known stud wall will be used as example in some of the following.

Basics of building physics

The transport of heat, air and moisture that takes place in the building envelope will influence its performance. In general this can be illustrated as a flow depending upon a difference in potential and a transport coefficient for the material or the structural part and its area, i.e:

$$Q = k \cdot A \cdot \Delta p$$

The flow, Q , can be volume flow of air or moisture or the flow of energy. Δp can be the difference in air pressure, vapour concentration, moisture content of material or temperature. The transport coefficient, k , can be permeability, vapour transmission coefficient or thermal conductance.

For the evaluation of the performance of the envelope other factors have to be considered as well. Such factors are the capability to store heat or moisture for a certain time. For the overall evaluation knowledge is also required about how air, moisture and heat are supplied to or taken away from the building or a part of the building.

Heat transfer

The heat transfer through the building envelope can be described by

$$Q = \frac{1}{R} \cdot A \cdot \Delta \mathcal{V}$$

where Q (W) is the heat flow through the area, A (m^2) at a temperature difference of $\Delta \mathcal{V}$ (K).

The total thermal resistance of the structure (R) depends on the thermal insulation material used and on design details such as the presence of thermal bridges. These factors can be included in the calculation of the thermal resistance.

For a light-gauge construction the thermal bridges are of special importance due to the high thermal conductivity of metals. This will lead to increase in heat transfer and also increase the risk of condensation on cold surfaces in the structure.

The thermal bridges of interest in an insulated light-gauge structure are load-carrying studs and distance elements of metal as well as lead-throughs and fasteners through thermal insulation and surface layers.



The extreme difference in thermal conductivity between metals and thermal insulation makes it possible to evaluate the influence from a thermal bridge by calculating the thermal resistance in a number of separate heat transfer paths taking into consideration in what areas interaction between thermal insulation and the metal is the most dominant.

Ideally installed thermal insulation normally leads to a wellknown thermal resistance or U-value. In practice deviations from this are common.

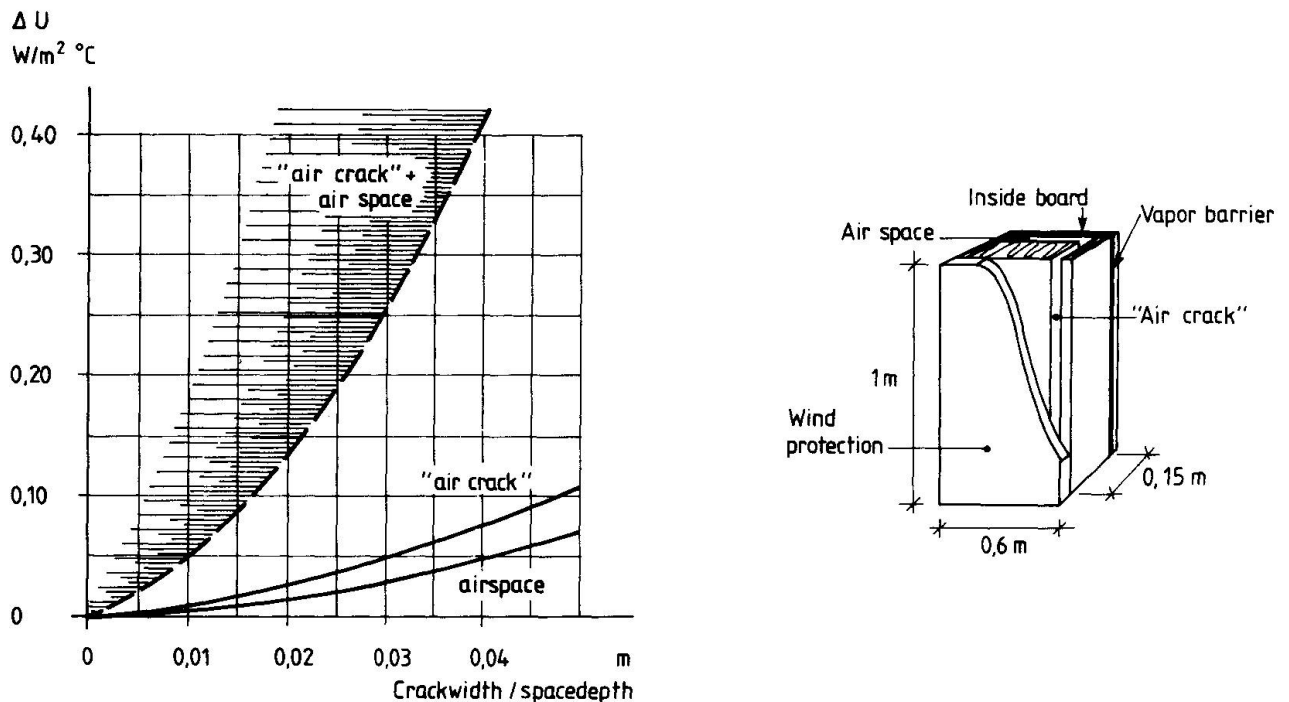

Figure 2

Deficiencies in the installation can often be attributed to the insulation not completely filling the space to be insulated. Cracks or air spaces may occur around the thermal insulation. Consequences of this is illustrated in figure 2 as increase in U-value for part of a wall where the insulation thickness is intended to be 0,15 m, giving a nominal U-value of 0,25 $W/m^2 \text{ } ^\circ C$.

The situation giving the largest, and most difficult to assess, increase in U-value is a combination of cracks and spaces around the thermal insulation. These difficulties will be more serious as the nominal thermal resistance of the structure is increased. Even small openings will degrade the thermal performance. Also the possibilities of air flow and its consequences on the thermal performance will depend upon workmanship for vapour barrier, joints and wind protection.

The thermal performance found in practice in a structure will be decisively influenced by workmanship and the airflow situation.

This is especially true for a structure with crossbars with high thermal conductance.

Air movements

Air movements in a material or a structure may influence its functions. Because of this the permeability of the materials and the structural parts are of importance when evaluating the performance of the building envelope.

The air flow G (m^3/s) through a material depends on the pressure difference Δp (Pa), over the material, its area A (m^2), thickness d (m) and permeability B_0 (m^2), i.e:

$$G = \frac{B_0}{d} \cdot \frac{A}{\eta} \cdot \Delta p$$

η (Ns/m^2) is the viscosity of air. For a board or a sheet its permeance B (m) is often used instead of B_0/d .

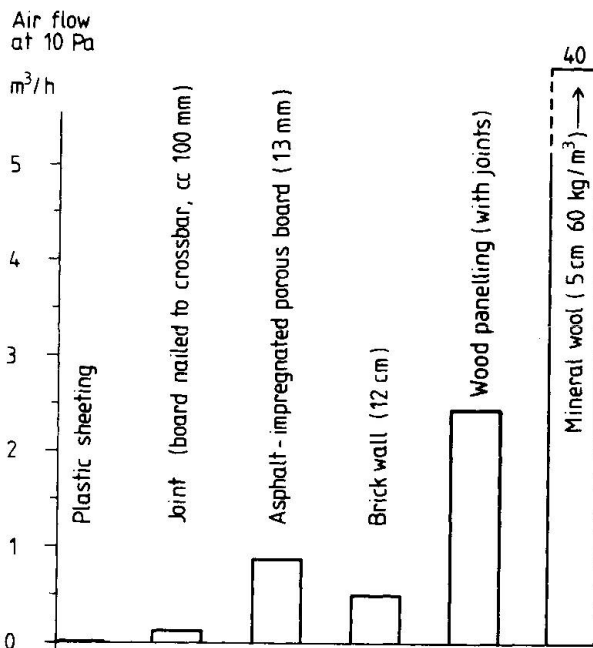
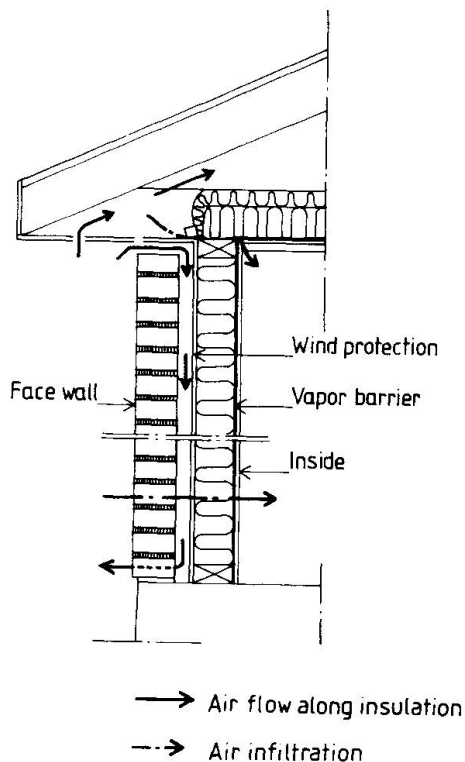

Figure 3 shows how a pressure difference will influence the air flow through different structural parts. The least permeable materials like plastic sheetings are used for the vapour barrier, the main air tightness layer in the building envelope.

Figure 3

Wind acting on a building envelope will lead to pressure differences and air flow in and around the structure. The actual situation will depend on wind velocity, building design, proximity to other buildings etc. Stack effect and mechanical ventilation will influence the pressure situation as well.



The air movements may influence the building envelope in different ways (Figure 4). In some cases air movements will ventilate spaces intended to be ventilated for example behind the outer facing of a wall. If deficiencies are present in the structure air movements may affect parts of the insulation. To protect against air movements in the thermal insulation some kind of wind protection is often used. The wind protection is especially important for parts of a building where pressure changes are large such as at corners, at eaves etc.

Figure 4

Another situation where wind protection is of great importance is when the installation of the insulation is deficient. This is illustrated in Figure 5, showing measurements on the wall section in figure 2.

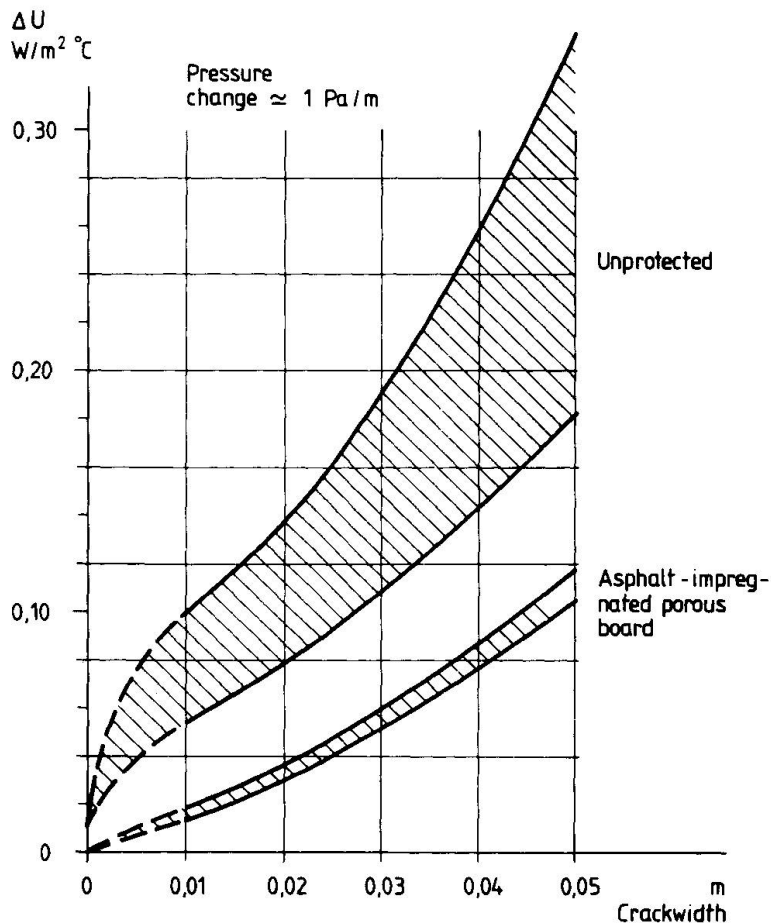

The figure shows the increase in U-value at a pressure change of 1 Pa/m in the air space along the insulation when wind protection or no wind protection is used and when there is an insulation deficiency in the form of a crack in the insulated space.

For the unprotected thermal insulation with installation deficiencies the effects are very large. The figure shows the importance of good workmanship both for installation of thermal insulation and for application of wind protection.

Figure 5

In other cases air may infiltrate through the building envelope. In many cases this is necessary for the normal ventilation of the building. In modern designs this air leakage means an unwanted increase of the heat loss from the building.

The airtightness of a multilayer structure is usually designed into the structure by use of a vapour barrier and by specially designed joints between different materials and building elements. If unwanted air infiltration is to be avoided it is necessary that these measures be well designed and realized by good workmanship.

Defects in the air tightness layer, i.e. usually the vapour barrier and the inside sheeting, will lead to an increase in air flow through the building envelope. This air flow is also of importance for the transportation of moisture through the building envelope. As a matter of fact this is one of the major factors when evaluating the moisture situation in the building structure.

Moisture

One of the most important objectives of the building envelope is to protect against rain and moisture. At the same time the structure shall be designed in such a way that it does not deteriorate due to the moisture situation in the materials.

The building envelope can generally be influenced by moisture from different areas at the same time. Such areas are driving rain, moisture in the air, building moisture, water in and on the ground. Often one of these factors is the dominant one.

Building moisture is generally considered the amount of moisture that has to be dried out in order to reach an equilibrium between the material or the building part and the surrounding climate. This initial moisture content can vary depending on the material but also on how it was treated before it was installed in the building. The driving rain on the outside of a building can vary both depending upon the climatic situation of the area in question and upon the air flow pattern at the outside.

Moisture can be supplied to a building element through precipitation, through condensation of water vapour from the air, through absorbing ground moisture or through leakage. In addition most materials in contact with humid air will absorb a larger or smaller quantity of water (hygroscopic moisture).

The moisture condition of the building is determined by climatic conditions, by the structural design and by the materials included in the building. In order to design a building structure correctly and to be able to judge the cause of possible damage, it is necessary to have knowledge of moisture and moisture transport.

The water vapour concentration in the air is usually specified as the weight of the water per unit volume v (kg/m^3). An alternative method of describing the dampness of the air is to specify the partial pressure p (Pa) of the water vapour.



WATER VAPOUR CONCENTRATION 10^{-3} kg/m^3

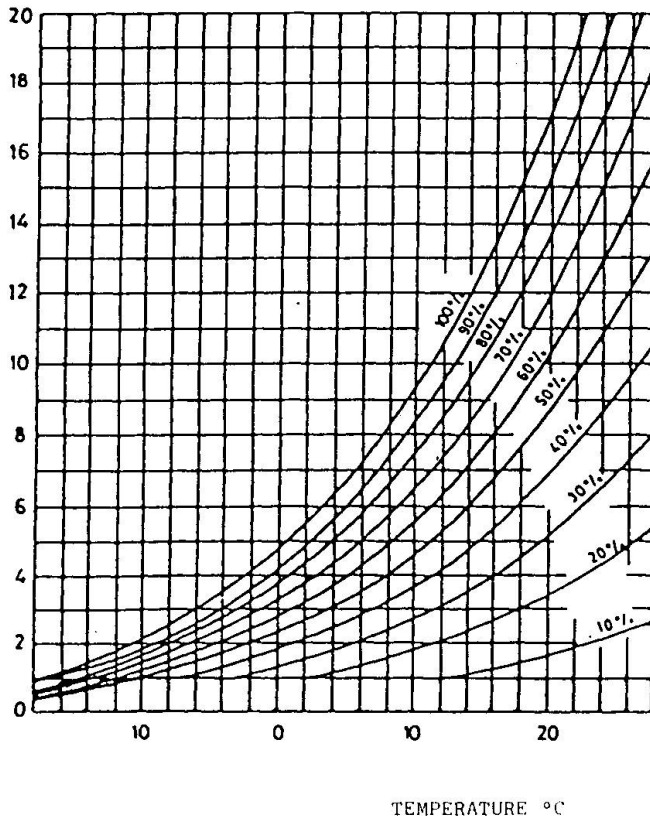

At a given temperature the air can not contain more than a certain volume of water vapour, the vapour concentration at saturation point. The saturation value v_s (kg/m^3) is strongly temperature dependent. This is shown in figure 6. The relative vapour concentration (relative humidity, RH, %) is the ratio between the actual vapour concentration and the vapour concentration at the saturation point.

Figure 6

The indoor humidity is determined by the temperature and relative humidity of the outdoor air, temperature of the indoor air, moisture supplied indoors and the ventilation rate. Winter conditions are often the most interesting. Cold winter air outdoors often has a high relative humidity but since the vapour concentration at saturation point is low the vapour concentration is also low. Through ventilation such air enters the building and is heated to the temperature of the indoor air. Additional moisture may be added due to evaporation from people, washing, cooking etc. This moisture production creates a fairly constant difference between indoor and outdoor vapour concentration. For industrial premises however with "wet" manufacturing conditions more careful examinations must be carried out in order to determine the supply of moisture.

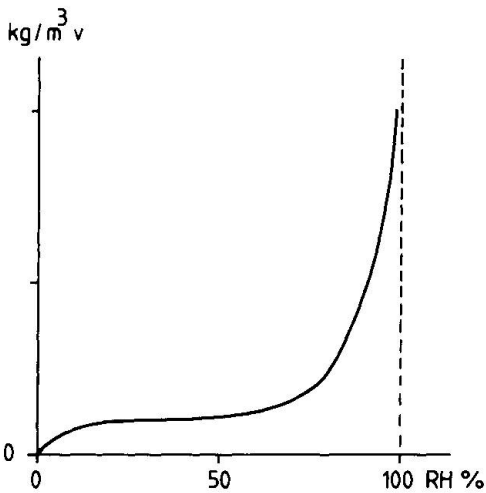

Figure 7

If a material is placed in an environment with a certain relative humidity the moist air will penetrate the pores of the material. A certain amount of moisture in the material will correspond to a certain ambient relative humidity. The state of equilibrium is called hygroscopic moisture content. An example of this is shown in figure 7.

The relationship shown is called a sorption curve. The sorption curves are different for different materials. They will also differ during dampening and drying but are as a rule fairly independent of temperature.

Materials with a wide moisture variation at varying relative humidities are said to be hygroscopic. Materials with little moisture variation are non-hygroscopic. Examples of the first type are concrete and wood of the other type cellular plastic and mineral wool.

To be able to evaluate the moisture situation in the structure the transport of moisture is of importance. Moisture can be transported both in vapour and in liquid phases. The moisture and temperature condition of the material as well as the structure of the material are of importance to moisture transport. Diffusion, convection or capillary suction dominate in ordinary cases.

Diffusion is a transport based on the efforts of a gas mixture to reduce local differences in vapour concentration. Diffusion is damped in a porous material and the vapour transport can be described as

$$g = \delta \cdot \frac{dv}{dx}$$

where g is the moisture flow ($\text{kg}/\text{m}^2 \cdot \text{s}$) and δ the vapour permeability (m^2/s).

At a difference in total pressure on either side of a structure air can flow through holes in the structure and carry moisture with it. If moist inside air is transported through the building envelope to its outer parts with lower temperatures there may be a risk for condensation.

In a house with natural ventilation a pressure difference is normally obtained if there is a temperature difference between indoor and outdoor air. The pressure difference will vary with the height of the house. Positive pressure will then be obtained in the top story and at the roof and indoor air can leak out through the envelope. It is therefore more common to find damp air flowing out of the upper part of a house and this is also where moisture damage on account of convection will be found.



The amount of moisture transported by convection can easily be evaluated from the water vapour concentration in air and the volume flow of air. Diffusion of moisture is as a rule a slow process and the diffused amounts of moisture are often small. The amount of moisture transport through moisture convection can be appreciably larger particularly if cracks or other leaks occur. A situation with moisture convection against cold surfaces and condensation may well be disastrous for the structure.

Light-gauge wall construction

An insulated light-gauge wall construction is shown in figure 8. This type is used in heated industrial buildings.

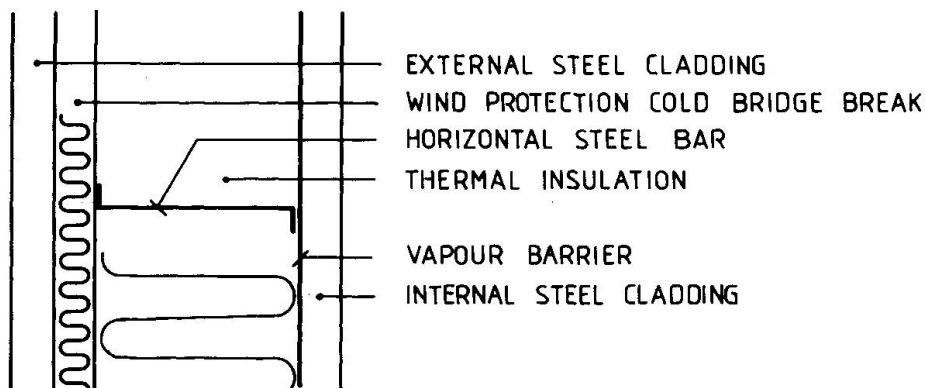

Figure 8

The wall is made of metal sheetings on steel studs, insulated with mineral wool with a vapour barrier on the inside and wind protection on the outside. In order to avoid cold bridges some kind of break in the cold bridge is necessary. Some of this can be supplied by the wind protection, which simultaneously protects the thermal insulation from air movements behind the outside sheeting. If the wall is made airtight by the use of a vapour barrier, for example a plastic foil on the inside of the insulation, there is no risk of condensation due to diffusion or moisture convection. It is also assumed that the outdoor sheeting is ventilated. Difficulties may arise when joining this wall airtight to e.g a roof. The plastic foil in the wall should join the vapour barrier in the roof with substantial overlap. It is also necessary to achieve an acceptable thermal resistance. By this it is also avoided that the surface temperatures locally on the inside of the wall will become so low that surface condensation may arise.

Building physics in light-gauge construction

In designing a light-gauge structure a number of factors should be considered for good building physics performance. These factors should also be evaluated on the basis of the climate in question. A cold storage warehouse is different from a conventional industrial building. Design for a cold climate is different from design for a warm climate. Especially the following points should be observed.

- Built in moisture shall be dried out in an acceptable time period
- Precipitation shall not be able to enter the structure
- Airtightness is required to avoid moisture convection and condensation
- A vapour barrier shall be installed so close to the warm surface that the relative humidity at the vapour barrier is acceptably low
- Ventilation is required in order to ventilate out moisture that has entered the structure
- Cold bridges that on the cold side may lead to melting of snow and on the warm side lead to surface condensation should be reduced
- Thermal performance of the envelope will depend upon good workmanship when installing the insulation.

In order to protect from air movements a wind protection and an airtight layer in the structure are of importance.

References

1. BANKVALL, C.G, Thermal performance of the building envelope as influenced by workmanship, ASTM-STP, Thermal Insulation, Materials and Systems 1986
2. BANKVALL, C.G, Air movements and the thermal performance of the building envelope, ASTM-STP, Thermal Insulation, Materials and Systems, 1986
3. NEVANDER, L E, ELMARSSON, B, Fukthandbok, Stockholm, 1981
4. NORDTEST, Field investigations of moisture problems in buildings, NT TECHN REPORT 041, 1984
5. JOHANNESSON, G, ÅBERG, O, Köldbryggor i plåtkonstruktioner, Lund institute of technology, Lund, 1981
6. KRONVALL, J, Air flows in building components, Lund Institute of technology, Report TVBH-1002, Lund 1980

Leere Seite
Blank page
Page vide

Insulated Roofs with Two Layer Steel Sheets

Toitures composées de deux tôles profilées en acier

Isolierte Dächer mit zwei Schichten von Stahlblech

Germund JOHANSSON

Assistant Prof.
Chalmers Univ. of Technology.
Göteborg, Sweden

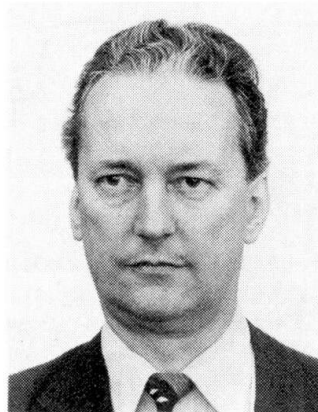

Germund Johansson, born 1937, received his civil engineering degree at Chalmers Univ. of Technology in 1962. After some years at a consulting firm for geotechnical problems he joined the Dep. of Steel and Timber Structures at Chalmers Univ. of Technology. His research interests are, among others, steel structures, roofs, and structural damage (due to snow, wind).

SUMMARY

A roof type consisting of two layers of profiled steel sheets is described. Between the two layers a thermal insulation is placed. Usually mineral wool or fiber glass with low unit weight is used. Due to the rise of energy cost and the need for thicker insulation this type of roof has been more commonly used during the last five years. Different factors influencing the function of the roof are discussed, e.g. moisture, heat transfer and air tightness. Results from field investigations on nearly 40 different roofs are discussed.

RÉSUMÉ

Il s'agit de la description d'une toiture constituée de deux couches de tôle profilée. Une isolation thermique est placée entre les couches. Habituellement, on utilise de la laine minérale ou de la fibre de verre à faible densité. Par suite de l'augmentation du coût de l'énergie et du besoin d'une isolation plus importante, ce type de toiture a été plus souvent utilisé au cours des cinq dernières années. Différents facteurs influençant l'efficacité de la toiture sont mentionnés comme par exemple l'humidité, le transfert de chaleur et l'étanchéité à l'air. Les résultats d'observations in situ sur environ 40 toitures différentes sont analysés.

ZUSAMMENFASSUNG

Eine Dachkonstruktion, die aus zwei profilierten Stahlblechen besteht, wird beschrieben. Zwischen den beiden Blechen liegt eine Isolationsschicht aus Steinwolle oder Glaswolle. Infolge der erhöhten Energiepreise und der Nachfrage nach dickeren Isolationen ist diese Art von Dach in den letzten fünf Jahren häufig gebaut worden. Verschiedene Faktoren, die die Funktion des Daches beeinflussen, werden beschrieben, z.B. Feuchtigkeit, Wärmetransport und Luftdichtigkeit. Ergebnisse einer Felduntersuchung von etwa 40 verschiedenen Dächern werden angegeben.



1. INTRODUCTION

The double steel deck with thermal insulation between the two layers of steel sheets has to a certain extent been used in Sweden during the last twenty years. During the end of the 1970's and in connection with increasing energy prices this type of roof has become more extensively used. There are several different types on the Swedish market. They differ among other things with respect to the degree of ventilation under the exterior steel sheet. Until now more than two million m^2 of such roofs have been built in Sweden. The main advantage is that insulation with lower density (and with lower costs) can be used in this type of roof than in a conventional built-up roof. Very thick thermal insulation is used in the roof. Thicknesses of 220 or 250 mm are common.

The investigations described here have been performed in close cooperation with Swedish steel sheet manufacturers and insulation manufacturers.

2. DESCRIPTION OF THE ROOF

The roof consists of a load carrying, trapezoidal steel sheet supported on main girders or purlins. A thin sheet plastic moisture barrier is placed on this steel sheet. On the top there is a waterproofing steel sheet placed on spacers. Thermal insulation is placed between the two layers of steel sheet, fig.1. The plastic sheet provides air tightness and prevents moisture penetration from the inside of the building. The spacers between the two layers of steel are of various designs. Most are designed to minimize heat loss. The most extreme spacing element is made of mineral wool and cold formed steel, fig.2.

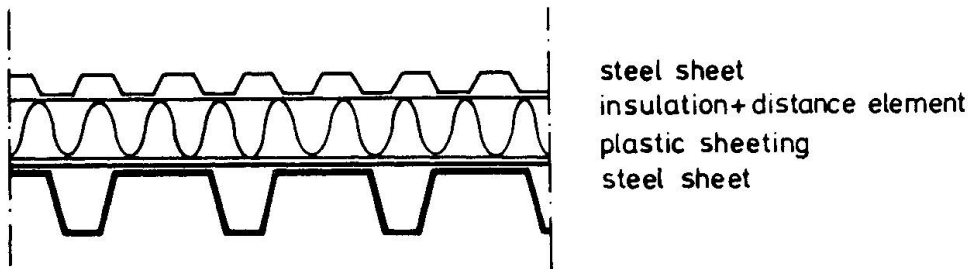

Fig.1 Cross section of a two layer steel sheet roof. Sketch showing the design principles.

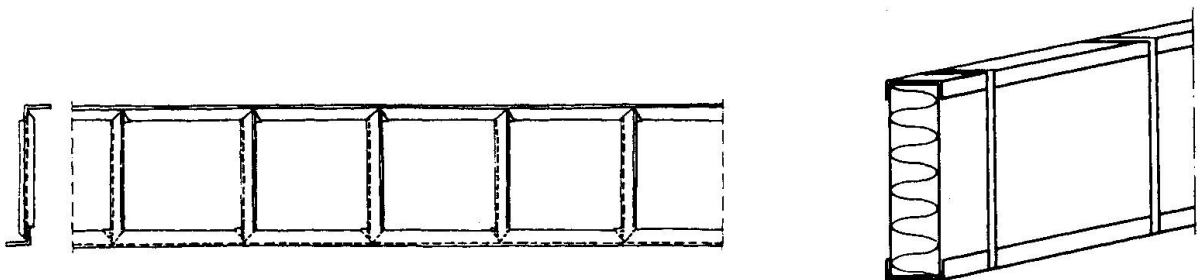

Fig.2 Different types of spacer elements, especially designed to minimize heat loss.

3. THERMAL INSULATION

This type of roof is used mostly with mineral wool or fiber-glass thermal insulation at least 150 mm thick. A thickness of 250 mm is also common. With these thick insulations thermal bridges play a great role in the thermal behaviour of the roof. Fig. 3 shows the coefficient of thermal transmittance (U-value), as influenced by the spacing of the spacer elements. In this example the spacers are assumed to consist of Z-purlins made of 1.5 mm steel plate. The U-value for a roof with 150 mm insulation and distance element with holes as in Figure 2 corresponds to a roof with 250 mm insulation having ordinary Z-purlins. U-value measurements show that spacers with holes are very effective. They increase the U-value very little over that of roof with no spacers. A roof with 270 mm mineral wool and spacers with holes, c.f. fig.2, had a measured U-value of 0.172 to 0.176 $\text{W/m}^2 \text{ } ^\circ\text{C}$ if the spacing is 0.95 m. With another type of perforated spacer, with a spacing of 1.45 m, and 150 mm mineral wool, the measured U-value was 0.27 $\text{W/m}^2 \text{ } ^\circ\text{C}$.

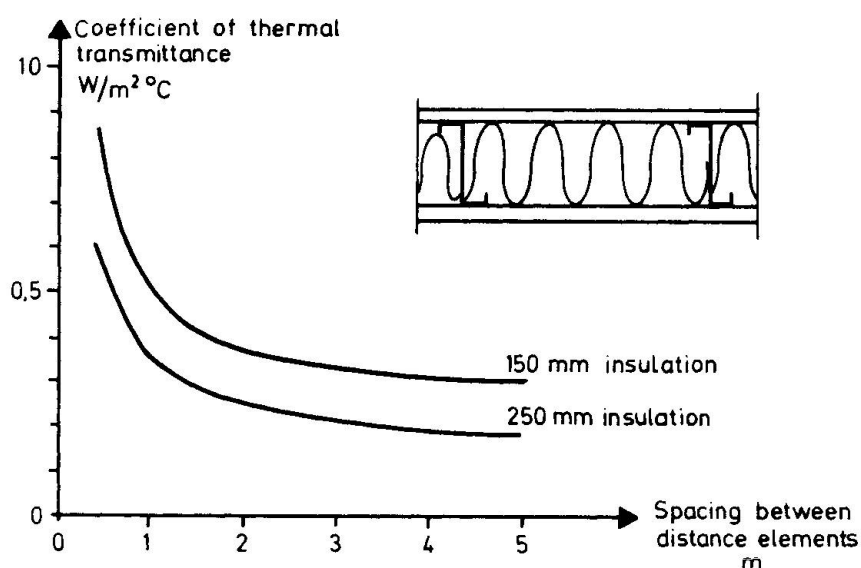

Fig.3 Calculated value of the coefficient of thermal transmittance U. Influence of spacing between the spacer elements. (Common Z-purlins, $t = 1,5 \text{ mm}$).

4. DESIGN PHILOSOPHIES

There are roof designs based on different philosophies on the market. There are systems with ventilated exterior steel sheet and systems without ventilation. In the former moisture that may enter the roof is supposed to be vented away. In the latter, moisture penetration is prevented. However, real roofs are more or less ventilated. Both these types have advantages and disadvantages.

The advantage of ventilated design is that water 'built in' or having leaked into the roof can be vented away. Under certain weather conditions the ventilating air introduces moisture rather than taking it away. This can happen with melting snow on the roof and humid air outdoors.

In the non-ventilated design, moisture cannot be brought into the roof by ventilation air. The risk of moisture entering from outside is minimized. It is also thought to be easier to waterproof the roof when it is non-ventilated.



The real roof always will be partly ventilated. Even a roof designed as a ventilated roof will behave as a non-ventilated roof during much of the winter, because snow plugs the ventilation channels.

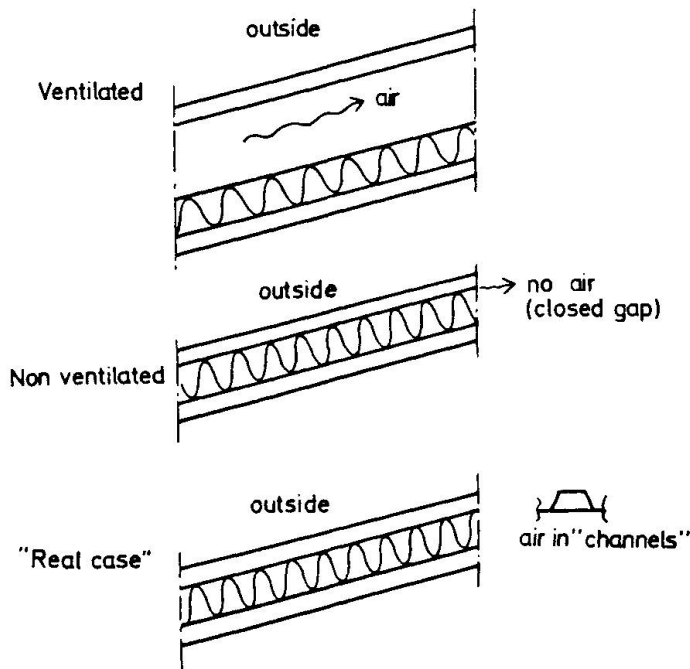

Fig.4 Different design principles for insulated roofs

5. WATER

A roof has to be tight against rain and water. For certain poorly designed roofs, rain can leak into the structure. Wind in combination with rain makes the water penetration more severe. The wind presses water into the structure.

There may be a static water pressure caused by ice walls. Ice can form dams near the eaves, or near warm gutters and drains.

6. CONDENSATION

There will always be moisture transportation through the roof. This will not cause any problem if the side laps of the load carrying steel deck are tight enough. If you have a poor design which permits inside air to come in close contact with the exterior steel sheet you may have some problems, especially if it is cold and the humidity in the building is high. Air transmission, which also means moisture transmission, depends on the pressure difference between the inside and the outside. But, just a small mist in the plastic layer will not cause trouble - the amount of air is not enough.

With a very poor design with big inside openings leading air into the structure, there must be moisture problems, fig.5.

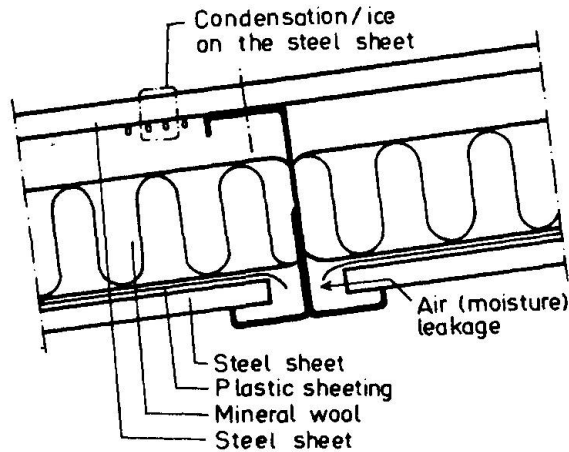

Fig.5 A very poor design leading to condensation problems

During the last years we have met with a few roofs with condensation problems, depending on mechanical ventilation. In one case there was an overpressure inside the building caused by ventilation fans. The measured pressure-difference was not large, just a few Pa. However, this low, but rather constant, difference was enough to force air from inside into the roof. When some of the exterior steel sheets and some of the insulation were removed the plastic film blow up like a balloon.

In another case there was air coming from the outside causing serious trouble with condensation on the inside of the outer steel sheet. Also in this case air was forced into the structure by fans. The condensation probably occurred mainly during the nights when the steel sheet may be about 10 °C colder than the air due to the heat radiation.

We have also looked at a leaking roof where everybody involved were convinced that there was a condensation problem. It was, however, possible to follow the way taken by coloured water from the outside, through the structure and into the office. That was not condensed water.

A very important rule is this:

- o Do not arrange the ventilation fans to create over-pressure inside the building. Make sure that there always is a lower pressure inside than outside the building.

7. MINERAL WOOL HOLDS WATER

If significant moisture quantities penetrates into the roof during short periods or on single occasions, it is important that the insulation is able to absorb the moisture and then release it when exterior conditions have changed. This quality is probably one of the reasons for the good experience with this type of roof in Sweden.



Some laboratory tests have been carried out to estimate the amount of water that the mineral wool can hold. The specimens ($0.15 \times 0.15 \times 0.1$ m), density 25 kg/m^3 , of mineral wool were kept under water. They were repeatedly slightly compressed in order to make the water go into the wool. After a while the specimens were removed and placed on pieces of wood in a plastic bag. During a period of six weeks the weight of the specimens was measured. At the end of the period the specimens were allowed to dry in the air at 20°C . The results of these measurements are shown in Figure 6. It can be seen that after six weeks the water content is still 150 kg/m^3 for horizontally stored specimens. This is to be compared with the maximum measured water content in a roof, which is about 5 kg/m^3 (0,5 percent of the volume). From Figure 6 it can also be seen the difference between horizontally and vertically stored specimens.

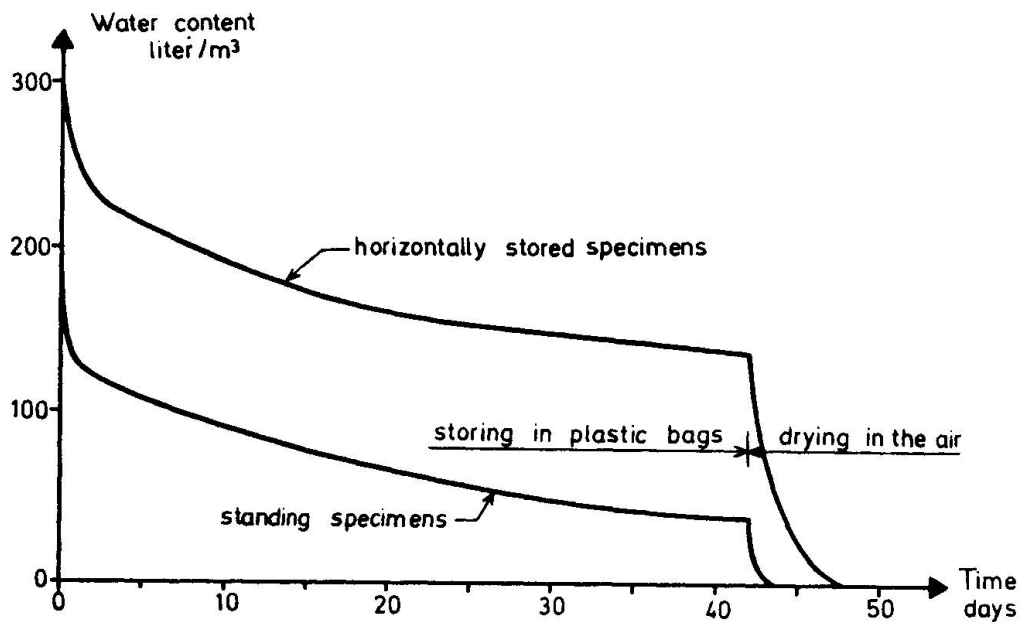

Fig.6 Laboratory tests of the drying process. Measured variation of the water content of initially wet rock wool. Each curve represents the mean value of 3 different tests.

8. FIELD INVESTIGATIONS

A lot of field investigations have been made in Sweden during recent years. More than 35 different roofs involving four different manufacturers have been investigated by Chalmers University of Technology. The roofs have an area ranging from 145 m^2 to 3700 m^2 . The roofs have a total area of 33300 m^2 . The slope of the roofs vary between 3.6 (1:16) and 23 degrees. The building period was 1977 to 1982. Most of the roofs are on single span buildings with outer gutters and drains. Just a few had warm interior drains. Most of the buildings had ventilation with underpressure inside (22) and five had overpressure ventilation. The rest had no fans at all or they had so called balanced ventilation which means that under certain condition and at certain points there is thought to be no pressure difference between the inside and the outside of the building. The real case might be "under-" or "over-" pressures ventilation.

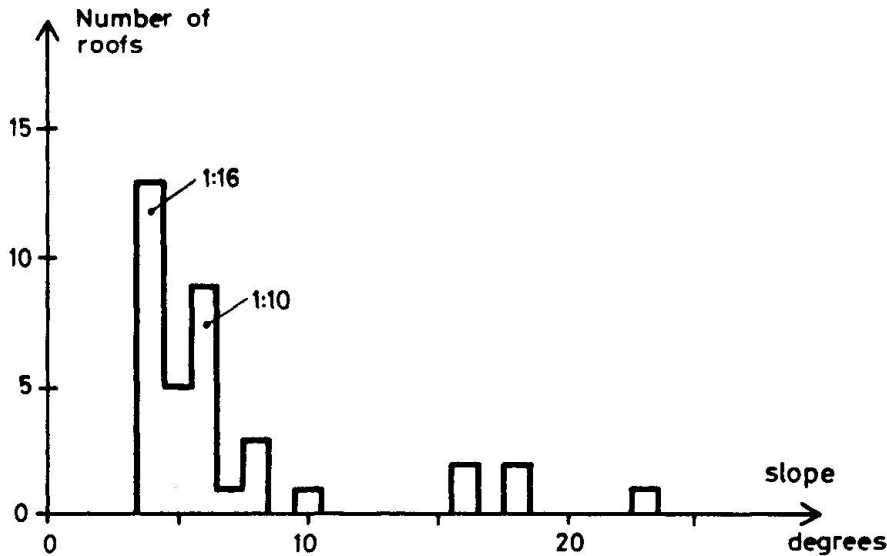

Fig.7 Roof slopes for investigated roofs

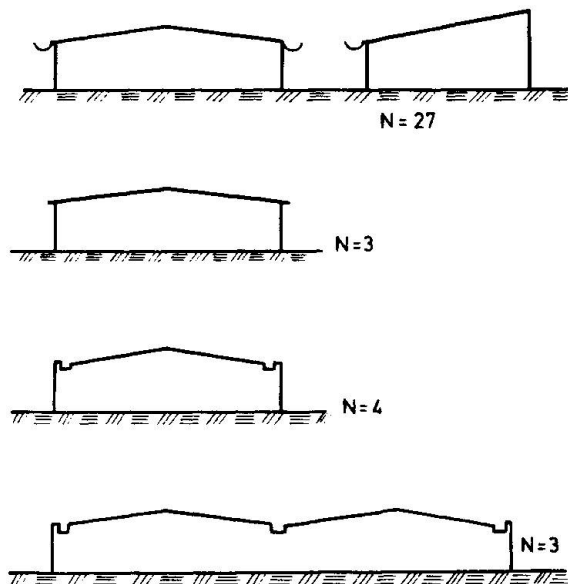

Fig.8 Investigated roofs. N is the number of roofs for each type

Figure 8 shows sketches of the different types of buildings investigated. In approximately half of the roofs there has been some water leakage. The leak mainly occurred at roof windows and ventilation ducts. However, there is no major difference in waterproofing between roofs with steel deck and roofs with roofing felt. The weak points are much the same. In order to minimize the risk of water leakage, the number of pipe penetrations has to be minimized. Also the leaks found were very often the result of poor workmanship and not of the roof design. There were drilled holes without screws or rivets. We also found skew screws which made leakage easier. The general impression of this type of roof was good, however.

One of the companies involved has performed moisture measurements on more than 10 roofs. Moisture variation is rather high but the roofs dried out during the summer. Figure 9 shows some results. When looking at Figure 9 remember that the insulation can hold more than 50 kg of moisture per cubic meter. At eleven roofs some of the outer plates were removed and examined. All but one had hoarfrost on the inside of the outer plate. However, the roofs dried out during the summer.



None of the roofs examined showed any signs of leakage or problems with condensation. The U-value was not examined, but no excessive heat loss has been reported.

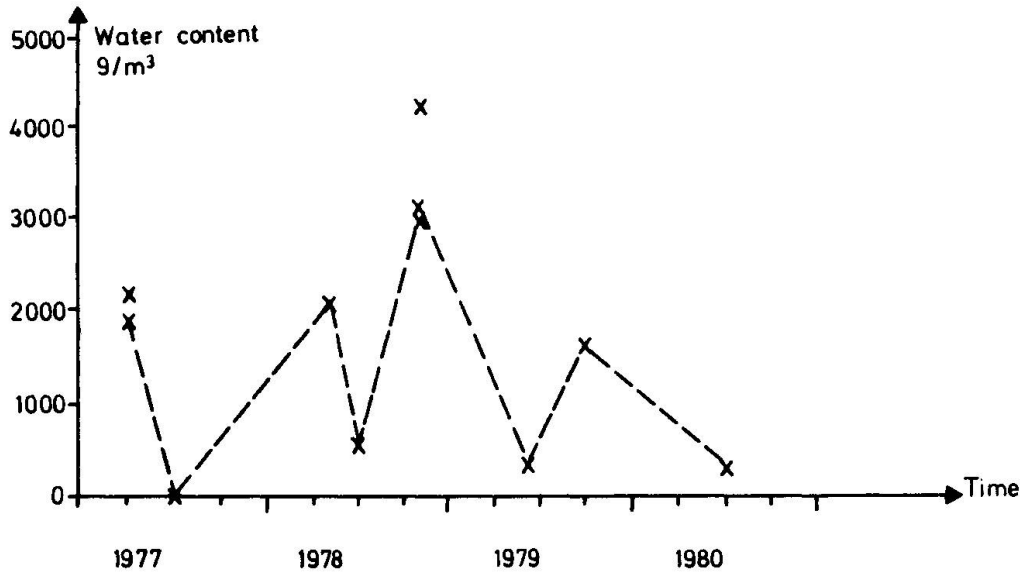

Fig.9 In situ tests. Measured variation of moisture content for a double steel sheet roof. The moisture disappears during the summer period.

9. REFERENCES

1. JOHANSSON G., Double Steel Decks (in Swedish).
Report R98:1984, Swedish Council for Building Research, Stockholm 1984.

Additional Insulation of Flat Roofs with Thin-Walled Metal Structures

Amélioration de l'isolation de toitures plates à revêtement métallique
à parois minces

Zusatzisolierung von Flachdächern mit dünnwandigen
Metallkonstruktionen

Ingemar HÖGLUND

Prof. Dr.
Royal Inst. of Technology
Stockholm, Sweden

Patrick ANDERSSON

Civil Eng.
Royal Inst. of Technology
Stockholm, Sweden

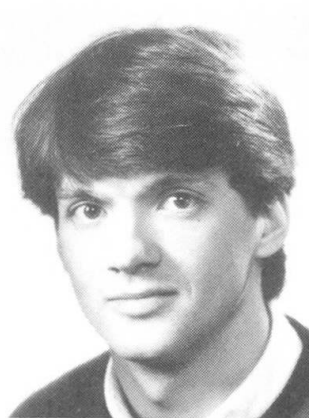

The authors are with the Royal Institute of Technology in Stockholm. I. Höglund is professor and head of the Division of Building Technology (from 1972). He has published extensively in the field of building science and energy conservation and participates in international collaboration. P. Andersson is a research assistant in the same Division.

SUMMARY

Rebuilding and improving the insulation of flat roofs by conventional methods at present leads to both technical and cost problems. For several reasons it is an attractive solution to place additional insulation directly on top of the outer surface of the roof. From a building physics point of view there is at the same time both improved moisture control and improved thermal resistance. The report analyses the pros and cons of this method. Comparisons are made with more conventional rebuilding methods.

RÉSUMÉ

La réfection et l'amélioration de l'isolation des toitures plates par les méthodes conventionnelles posent actuellement des problèmes d'ordre économique et technique. Pour plusieurs raisons, la solution la plus séduisante consiste à procéder à la pose de l'isolation additionnelle directement au-dessus de la surface extérieure du toit. Du point de vue physique du bâtiment, le contrôle de l'humidité ainsi que la résistance thermique se trouvent simultanément améliorés. Ce rapport analyse les avantages et inconvénients de cette méthode. Des comparaisons sont faites avec des méthodes de réfection plus conventionnelles.

ZUSAMMENFASSUNG

Umbau und Verbesserung der Zusatzisolierung von Flachdächern mit konventionellen Methoden verursachen technische und finanzielle Probleme. Man erhält eine ansprechende Lösung, wenn die Zusatzisolierung auf die Aussenseite des Daches aufgelegt wird. Vom bauphysikalischen Standpunkt wird auf diese Weise sowohl eine bessere Feuchtigkeitskontrolle als auch ein besserer Wärmewiderstand erreicht. In diesem Bericht werden die Vorteile und Nachteile dieser Methode besprochen.



1. FLAT ROOFS — INTRODUCTION

In Sweden in the fifties it became more common to build houses and public buildings with roofs with a shallow pitch of about 4° . Between 1950 and 1979 about 150 million m^2 of flat roof were built with weatherproof roofing felt but other types of roofing material, for example metal sheeting, were also used.

Many of these flat roofs are now in urgent need of renovation because:

- the weatherproof covering is old and worn and must be replaced. The life of roofing felt varies between 15-25 years depending on factors such as the method of laying and maintenance. The roofing felt on many roofs is now 20-35 years old, so replacement is necessary,
- thermal insulation is in many cases not satisfactory, being under-dimensioned by present-day standards,
- many roofs have been affected by moisture penetrating from inside and outside. Increased moisture content in roofs leads to poorer thermal insulation and an increase in mould and rot attacks.

Conventional methods of rebuilding and improving the insulation of these types of roofs have led to both technical and cost problems. Conventional methods involve i.e. removing the old roof, building up the roof trusses, adjusting the vapour barrier, putting in additional insulating material. Naturally this is a relatively expensive process.

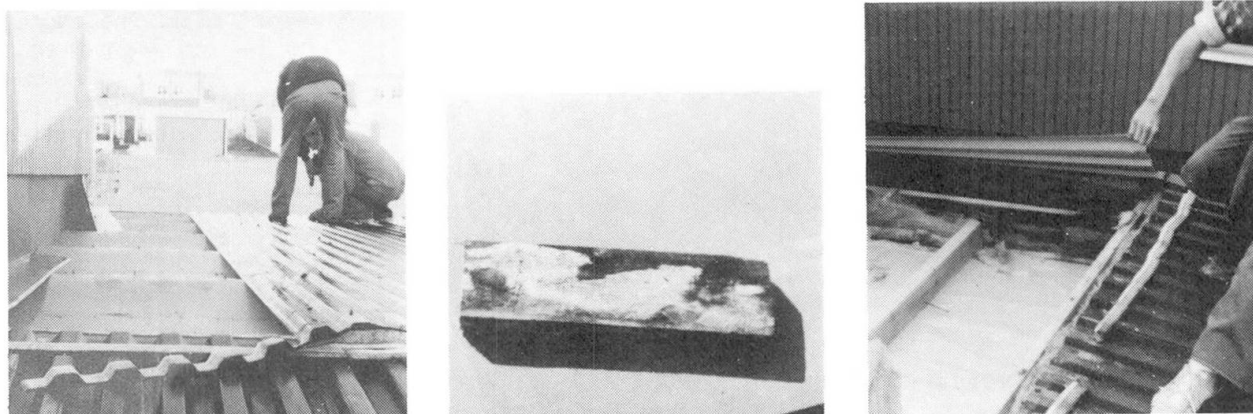

Fig. 1 Moisture damaged flat roof with metal sheeting. Moisture penetration from both the inside and the outside. The fibre board hung down, thus blocking the vented air space. The moisture content in the construction increased and caused mould and rot damage. (Example 1.)

1.1 Does external additional insulation improve the moisture level in the roof?

Now, however, it is hoped that it will be possible to solve insulation and moisture problems in a simpler way. Additional insulation is simply placed on top of the old roof. By improving the insulation in this way the work is made easier and more cost-effective.

A few buildings in Denmark and Sweden have been rebuilt in this way. If recommendations and guide lines of a more general nature are to be given, however, it will be necessary to acquire greater experience and theoretical understanding of the problems involved in rebuilding flat roofs.

In a current R & D project (financed partly by grants from the Swedish Council for Building Research) at the Division of Building Technology, RIT, Stockholm, a number of different roofs with additional insulation are being studied. These are mainly flat roofs with additional insulation placed externally. The investigation comprises both experimental and theoretical studies. Variations in

the moisture level, thermal-insulating effect, costs and cost-effectiveness are studied. Calculations and measurements are made before and after renovation. From a technical point of view the renovated construction is expected to function in the following way:

- the original roofing (with possible additions) acts as a new vapour barrier for the additional insulation,
- the additional insulation causes a rise in the temperature of the construction. This rise is dependent on the thermal resistance of the additional top insulation and the extent to which the ventilation of the roof is retained,
- the rise in temperature lowers the relative air humidity (R.H.),
- the lower R.H. causes a wood construction to dry out, i.e. the moisture ratio decreases,
- when the moisture ratio is less than about 15% (by weight) the roof ventilation is closed off to gain the full effect of the additional insulation. With moisture ratios of less than about 15% there is judged to be no risk of mould and rot damage. Regarding mould fungi marginal attacks may occur at moisture ratios below 20% for wood. A few less common types may develop at about 15%. The majority of types of mould fungi, however, require considerably higher moisture ratios than 15%.

The thermal resistance of the additional insulation is dimensioned according to constructional and cost aspects. Since the new construction has the vapour barrier inside the construction, the thickness of the additional insulation has to be decided upon so that condensation does not occur against the vapour barrier and so that the relative humidity of the air is kept at an acceptable level. As a general guide it can be said that the additional insulation should have at least the same thermal resistance as the original roof had.

Other advantages of placing additional insulation on the outside of the roof are:

- by using thermal insulating materials cut at an angle it is possible to build a steeper slope towards the drain. This leads to reduced thermal resistance and consequently increasing surface temperatures towards valleys and gutters, which improves the run-off of melting snow,
- the roof construction will not be exposed to such high surface temperatures in summer and air temperatures in the upperstorey will be lower in summer,
- the roof construction maintains a more even temperature throughout the year, which means that thermal-related movements and stresses will be reduced.

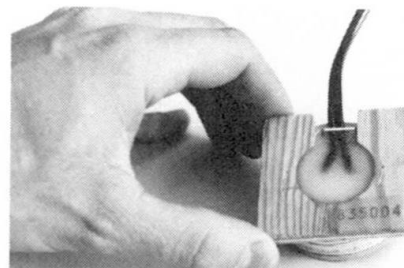
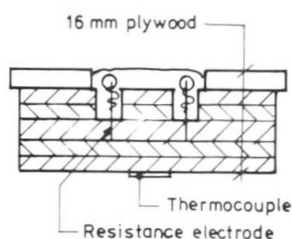

Fig. 2 Moisture-measuring gauge used in the field investigations. The gauge is built into the roof decking. The electrodes, insulated except at the tips, measure the electrical resistance of the plywood. The thermocouple helps to correct resistance measurements for temperature. By using a relation curve of electrical resistance and moisture content in the measuring gauge, it is possible to determine the moisture ratio in the measuring gauge and thereby the moisture ratio in the roof.



The drawback of the above-described method is that there is a risk that mould and rot are enclosed. It is therefore important to see to it that any affected parts are replaced before the additional insulation is laid on. This insulation will be lying between two waterproof layers, so it is very important that it is very well protected from precipitation during rebuilding.

2. FIELD STUDIES

In the following we will present some examples of damage caused by moisture in three types of flat roof with thin-walled metal sheeting and how these roofs were treated. Some theoretical and experimental results are presented.

2.1 Example 1

The investigation covered an estate of terraced houses in central Sweden built in 1973-74, comprising about 100 houses. The roof covering is metal sheeting and the pitch is only about 4° . The roof is ventilated and the ventilation is at right angles to the pitch. For the original roof construction and rebuilt roof see Figs 3 and 4. During the very first winter moisture patches appeared in the roof and walls. We established that the damage was due to moisture penetrating from both within and without.

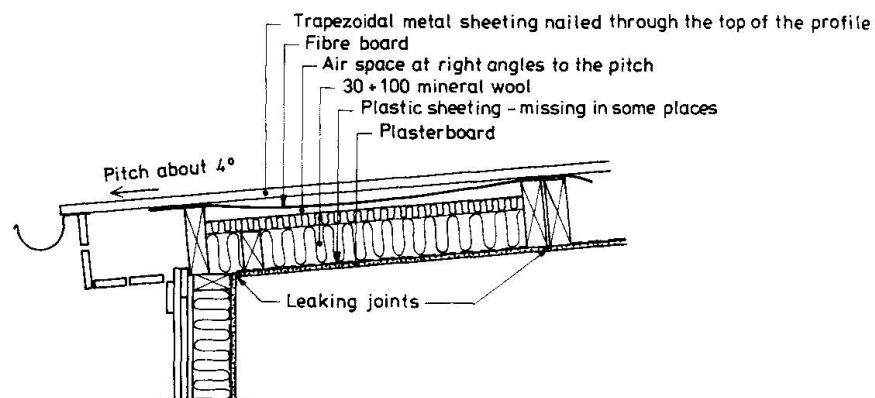

Fig. 3 The roof construction consists of prefabricated elements. Owing to leaks at the joints the inside air was able to leak into the construction, where it condensed against the metal sheeting. Outside moisture was also able to penetrate the roof. Owing to swelling from damp the fibre boarding hung down blocking the vented air space.

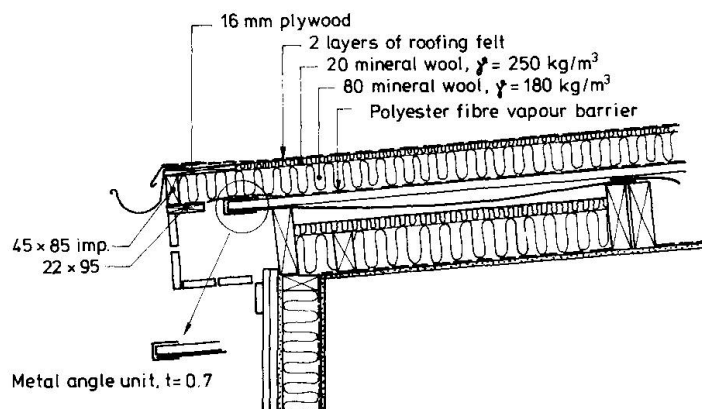

Fig. 4 Rebuilt roof. The ventilation was closed off. As the joints in the metal sheeting were not tight, a sheet of roofing felt was laid on the metal as a vapour barrier. The additional insulation was nailed on.

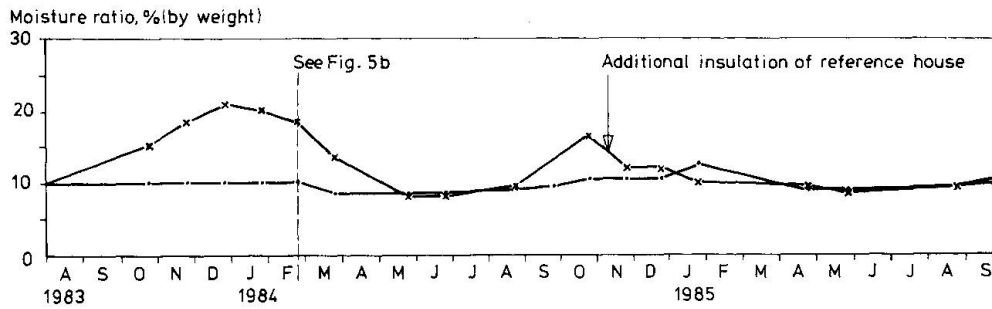

Fig. 5a Example of results. Moisture and temperature measured in three houses at the fibre board. Two houses additionally insulated and instrumented in summer 1983; the third house acted as a reference house and was not insulated until November 1984. During the winter of 1983-84 the effect of these measures could clearly be observed. In the additionally insulated roofs the moisture ratio remained at a low level, c. 10% during the whole period. In the house without additional insulation, however, the moisture ratio rose during the autumn and winter and reached its highest level c. 20% in Dec.-Jan. During the warm spring of -84 the roof dried out and the moisture ratio dropped to about 8%. During the autumn of -84 the moisture ratio rose again, only to drop immediately after the roof was additionally insulated in November -84. Since additional insulation all the roofs have had a low moisture ratio.

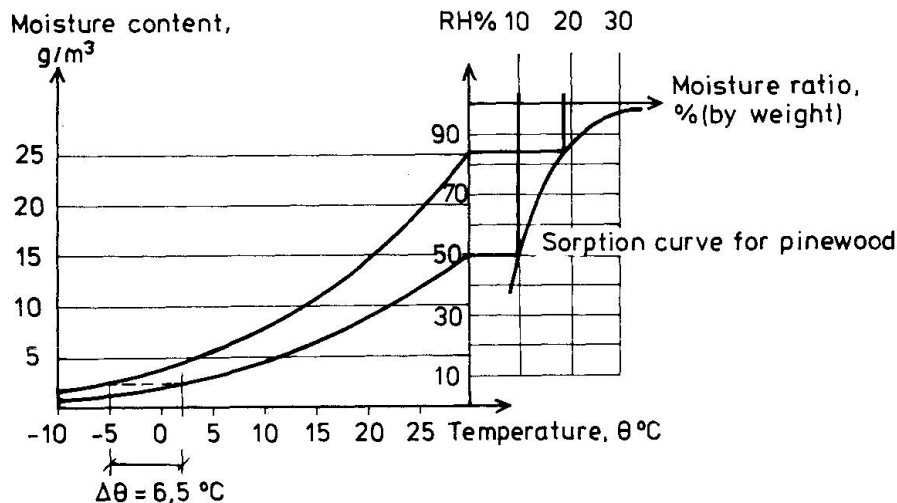

Fig. 5b The measurements in February -84 for the roof without additional insulation showed a moisture ratio of c. 18%, which corresponds to a relative humidity of 85% in the ventilation channel. The temperature in the air space was -5°C . In the additionally insulated roofs the additional insulation resulted in the temperature rising to $+1.5^{\circ}\text{C}$. With the same vapour content as for the roof without additional insulation this gives a relative humidity of 50% in the air space. This corresponds to a moisture ratio of c. 10%, which agrees with the value obtained (see Fig. 5a). Theory and practice agree nicely.

2.2 Example 2

Example 2 comprises a double metal sheeting roof on an office and factory building south of Stockholm. The roof area is c. 1700 m^2 and the pitch c. 4° . For roof construction see Fig. 6.

During the winter months dripping from the ceiling caused a problem. This was due to moisture transport by air convection caused by leaks between the vapour barrier in the ceiling and the structural beams. Since the construction does not contain organic material, damage to the ceiling was restricted to impaired heat



insulation. However, for practical and hygienic reasons the "rainfall" from the ceiling could not be tolerated. The problem was solved by using external additional insulation, see Fig. 7.

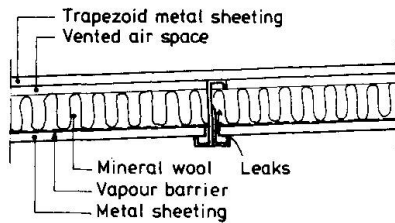

Fig. 6 Double metal sheeting roof. Warm, moist air penetrated owing to leaks between the vapour barrier and structural beams caused condensation against the outer metal sheeting during cold periods.

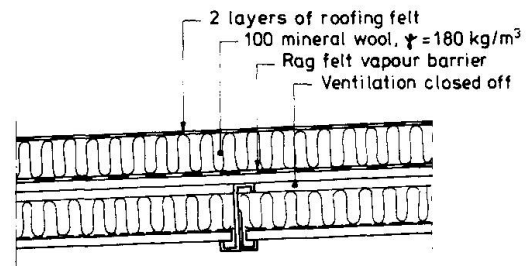

Fig. 7 Roof construction after rebuilding. A vapour barrier of rag felt was glued to the roof to prevent air convection. Dripping from the ceiling has stopped.

After additional insulation of the roof in spring 1983 dripping from the ceiling stopped and the roof now functions perfectly. Moisture and temperature are measured in the roof to check the moisture content there. See Fig. 8.



Fig. 8 Example of results. Moisture and temperature are measured both in the air space, line 1 and immediately below the new weatherproof layer, line 2. Since additionally insulating the roof the moisture ratio in the roof has remained for the whole period at a low level, c. 8% in the air space and c. 10% under the new weatherproofing. However, the moisture ratio at one of the measurement points immediately below the new weatherproofing was c. 20%, which indicates that moisture has been enclosed. Moisture is measured by means of built-in moisture-measure gauges; figures refer to the moisture ratio in these rounds.

2.3 Example 3

Example 3 comprises eight rows of terraced houses north of Stockholm. The roof is a butterfly construction consisting of two shallowly pitched (c. 0.5°) roof surfaces converging on a central line where the drainage is placed. For roof construction, see Fig. 9.

After a time moisture patches appeared on the ceilings and inner walls. The damage was caused by moisture penetrating from outside. Owing to initial shrinking and temperature movement in the polystyrene slabs gaps appeared between these slabs. The roofing felt then split above the gaps and water was able to penetrate the roof.

In summer 1984 the roofs were rebuilt as strutted roofs covered with metal sheeting. The sheeting was fastened to a steel construction which was in turn fastened to the concrete frame with expander bolts. See Fig. 10.

In order to fasten the steel construction to the concrete slab holes were cut in the weatherproofing and insulation. After raising the construction these holes were made watertight. In one row of houses the work was done unsatisfactorily, since rainwater penetrated the roof before the metal sheeting was placed in position. Thus, it is of the greatest importance that the holes are made watertight with great care, as even the smallest holes can lead to serious water leaks.

Moisture and temperature are measured in two houses, see Fig. 11.

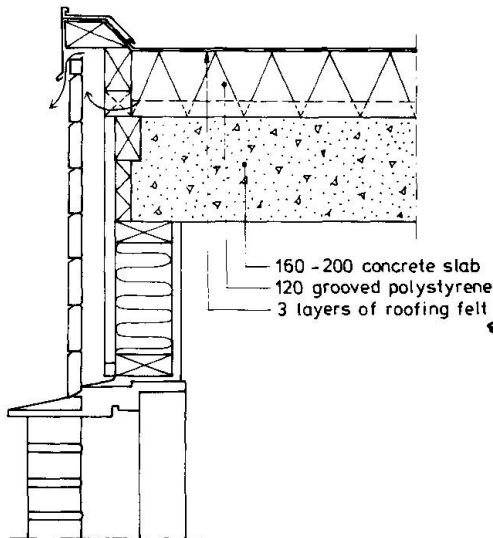

Fig. 9 Attachment to eaves of original roof.

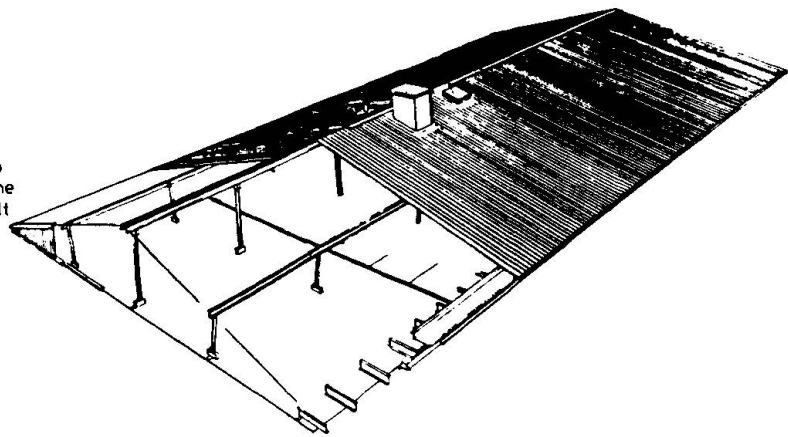

Fig. 10 New strutted outer roof of metal sheeting with a 14° pitch. The roof was additionally insulated with 120 mm of mineral wool. The original internal drainage was closed off. The new roof was provided at the eaves with guttering connected to the storm-water drainage system.

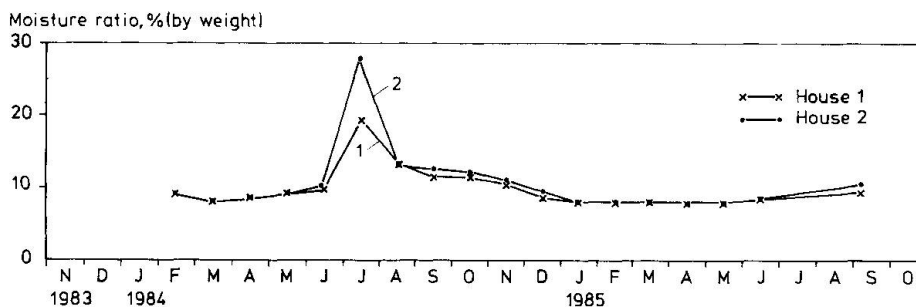

Fig. 11 Example of results. Moisture is measured by means of built-in wooden rounds placed between the concrete slab and the cellular plastic insulation. The large increase in the moisture ratio in June-July was caused by the leaks in connection with raising the steel construction. Apart from this incident the moisture ratio has remained during the whole period at an even and low level (8-10%). The moisture ratio values refer to the moisture ratio in the moisture-measuring gauges.



3. FIRE PROTECTION

The new method using external additional insulation of flat roofs with the roof ventilation closed off, has also appeared to be efficient in preventing the spread of fire. This was revealed in the autumn of 1984 when there was a fire in one of the investigated housing areas (terraced houses). After the fire, the adjacent houses remained totally intact partially because of the use of this method.



4. FLAT ROOFS CAN BE REBUILT SAFELY AND COST-EFFECTIVELY

We have reported on three investigations in the project. The buildings (with external additional insulation) which have been investigated have up to now functioned well and the results obtained indicate that practice and theory are in good agreement.

Tenders were sought for rebuilding the three buildings described in the report, using both additional insulation and a strutted roof construction. In all cases the use of the external insulation method proved to be almost 50% cheaper than using a strutted roof.

ACKNOWLEDGEMENT

The project is sponsored by the Swedish Council for Building Research.

REFERENCES

1. HÖGLUND, I. & ANDERSSON, P., Ombyggnad och tilläggsisolering av flacka tak. (Department of Building Technology, RIT.) Bulletin No. 143. Stockholm 1984.
2. KORSGAARD, V., CHRISTENSEN, G., LOHSE, U., PREBENSEN, K. & BRANDT, J., Merisolering af flade tage. (COWI Consult, Rådgivande Ingenjörer AS.) Bulletin No. 418. Copenhagen 1981.

Thermal Bridges in Sheet Metal Construction

Ponts thermiques dans la construction en tôle métallique

Wärmebrücken in Blechkonstruktionen

Gudni JOHANNESSON

Dr. Eng.
Reykjavik, Iceland

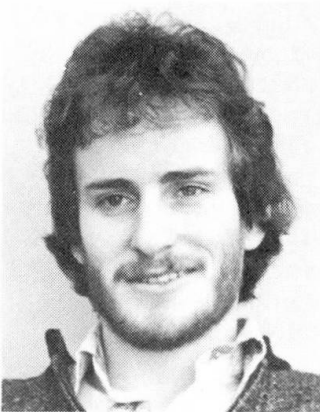

Gudni Johannesson M.Sc. in physical engineering 1976. Dr. Eng. in building technology 1980. Thesis: «Active Heat Capacity – Models and parameters for the thermal performance of buildings». 1975 to 84 at the Division of Building Technology, Lund Institute of Technology. Now active as a consultant in Iceland.

Hans A. VINBERG

Tekn. lic.
Korrugal AB
Finspång, Sweden



Hans Vinberg, born 1925, civil engineer 1949 at KTH, Stockholm, and tekn. lic. 1951, is responsible for technical development at Korrugal, a producer of building sheet of aluminium.

SUMMARY

Purlins or spacers often give fatal thermal bridges. These can cause extra heat loss and low temperatures. A method to calculate the effect of thermal bridges is described. The thermal flows are treated as electrical flow, the insulations in different parts as electrical resistances. The effect on different constructions is described.

RÉSUMÉ

Les pannes et entretoises constituent souvent des ponts thermiques, entraînant des déperditions de chaleur supplémentaires et un abaissement de la température. L'article décrit une méthode permettant de calculer l'effet des ponts thermiques. Les flux thermiques sont traités par analogie avec les courants électriques, les isolations étant considérées comme des résistances. Les effets des ponts thermiques sont décrits pour différents types de constructions.

ZUSAMMENFASSUNG

Pfetten und Abstandhalter bilden häufig Wärmebrücken. Diese können zusätzliche Wärmeverluste verursachen. Eine Methode zur Berechnung der Auswirkung von Wärmebrücken wird beschrieben. Der Wärmefluss wird als elektrischer Strom, die Isolierung als elektrischer Widerstand behandelt. Die Auswirkung verschiedener Konstruktionen wird beschrieben.



1. INTRODUCTION

The effect of thermal bridges can be calculated by the Johannesson-Åberg method which now is Swedish standard [1].

In order to accomplish simplified calculation methods a research project, sponsored equally by Swedisol and the Swedish Building Research Council, was accomplished at the Division of Building Technology, Lund University. The result was a calculation method which is published in [2].

2. THE PROBLEM

The heat flow problems can be illustrated by means of a construction, consisting of two parallel corrugated sheet metal layers, connected by a sheet metal purlin and with insulation in between. The thermal conductivity for steel is about 1500 times as high as the thermal conductivity for mineral wool. Consequently, if the surfaces of the construction were isothermal, the heat flow per meter through a purlin of thickness 2 mm would equal the heat flow per meter through 3 m of insulation. If we on the other hand assume that no lateral heat flow takes place and the U-value for the construction can be calculated by weighing together by areas the one-dimensional U-value for different sections, the resulting U-value will differ only slightly from the one without a thermal bridge since the lateral heat transfer is neither zero nor infinite and the real thermal bridge effect lies somewhere in between the results of the two different observations described above. The key to a simplified formula is to model the lateral heat flow in different parts of the construction and to provide a suitable coupling to the transversal heat flow.

3. THE DEVELOPMENT OF A NEW CALCULATION METHOD

The solution methodology presented below assumes that one proceeds in three steps. The first step is to divide the construction into a number of separate heat flow paths. In the second step the resistance of each heat flow path is calculated. In the third step the different resistances are coupled to form a network for which the resistance can be calculated analogously to electrical resistance theory.

Below a distinction is made between the thermal resistance R , K/W between two arbitrary configurations in space defined by the equation

$$R_{12} = \frac{\vartheta_1 - \vartheta_2}{Q_{12}} \quad , \quad \vartheta = \text{temperature [K]}, \quad Q = \text{heat flow [W]},$$

and the areal thermal resistance $m, m^2\text{K/W}$ between two plane parallel surfaces

$$m_{12} = A \cdot \frac{\vartheta_1 - \vartheta_2}{Q_{12}} \quad , \quad A = \text{area [m}^2\text{]}.$$

3.1 Identification of heat flow paths

To break down a construction into different heat flow paths requires insight in the actual heat flow pattern and can therefore not be done by means of an explicit solution method.



The construction (fig 1) is transformed into a network of resistances. R_u and R_i are outer and inner surface resistances, R_1 and R_5 characterize an effective mean flow path along the surfaces to the purlin, R_2 and R_4 flows through the insulations 2 and 4 and R_3 is the resistance for the purlin. All the resistances are related to some representative area. The remaining thing to do is to describe the different resistances with suitable expressions.

3.2 Resistances for different construction parts

Below resistances are given for some simple configurations that are of use for the continued analysis. The expressions used can be found derived in most text books on heat transfer. See for instance Carslaw and Jaeger [3].

3.2.1 One-dimensional heat flow

The resistance is given by the equation

$$R = \frac{d}{A \cdot \lambda} \quad , \quad \lambda = \text{thermal conductivity [W/mK]} .$$

3.2.2 Heat transfer from a thin layer with high thermal conductivity and surface heat transfer

If heat is generated at a constant temperature ϑ_0 and if the heat flow at the edge can be neglected, the resistance is given by the expressions

$$R = \frac{1}{L \sqrt{\alpha \lambda t} \tanh \beta b}$$

$$\beta = \sqrt{\frac{\alpha}{\lambda \cdot t}} \quad , \quad \alpha = \text{coefficient of surface heat transfer [W/m}^2\text{K]} .$$

$$\text{If } b \geq 2 \sqrt{\frac{\lambda \cdot t}{\alpha}} \quad , \quad b = \text{partial width [m]} ,$$

then the term $\tanh \beta b$ is approximately equal to 1.0.

As an example the resistance between a purlin joint with temperature ϑ_0 and ambient outside air with temperature ϑ_u is calculated. The purlin flange is neglected, the corrugated sheet metal layer is assumed to be planar and a perfect thermal contact between the purlin and the layer is assumed. If the considered length is 1 m then each side gives the resistance

$$R = \frac{1}{1 \cdot \sqrt{20 \cdot 60 \cdot 0.001} \cdot 1} = 0.912 \text{ K/W}$$

and for both sides the resistance becomes

$$R = \frac{0.912}{2} = 0.456 \text{ K/W}$$

The thermal bridge and the homogeneous part of the construction have the surface resistances in common. Since R above contains even the surface resistance this has to be adjusted for. The resistances R_1 and R_5 of fig. 1 would therefore be given by the formula

$$R = \frac{1}{2L \sqrt{\alpha \lambda t} \tanh \beta b} - \frac{2}{2bL\alpha}$$



This resistance then characterizes some actual mean heat flow path along the surface layer.

4. A GENERAL CALCULATION MODEL

Based on the solutions given above for simple heat flow paths a general solution method for the usual type of built up sheet metal construction can be established. The construction type together with corresponding resistance network is given in fig 1 where the formulae for the different partial resistances also have been implemented.

Calculation of the resulting U-value for the construction is best carried out in several steps. First the resistance for the thermal bridge R_{TB} is calculated

$$R_{TB} = R_1 + R_2 + R_3 + R_4 + R_5$$

Then the construction resistance R_C is obtained by combining R_h and R_{TB} as two parallel resistances.

$$R_C = \frac{R_{TB} \cdot R_h}{R_{TB} + R_h}$$

Adding the surface resistances R_i and R_u gives the total resistance R_{TOT} .

$$R_{TOT} = R_C + R_i + R_u$$

The total areal resistance m_{TOT} is then given by

$$m_{TOT} = R_T \cdot B \cdot L$$

and finally the U-value is obtained as

$$U = \frac{1}{m_{TOT}}$$

5. THE EFFECT OF THERMAL BRIDGES

What effect do different thermal bridges give? If we use this method and calculate a roof or a wall with three different thicknesses – 50, 100 and 200 mm we find that the extra energy loss is often 40-70%, caused by the thermal bridges.

The following examples are taken with measurements, that are normal in industrial buildings. (The details are given in [4]).

The types are shown in fig. 2, where the values are for 200 mm thickness.

A steel purlin with normal spacing gives about 75% extra heat flow through the construction (type 2). With a breaking layer this goes down to about 25%, but with the support, that is often needed, it gives up to 40% again.

Wood is of course a better insulator than steel. A wood purlin gives around 8% extra loss.

There are some "stepped spacers", with holes in the steel purlins, aimed to reduce the heat flow. They give some 15-30%.

A special spacer, made of compressed mineral wool, held together with stainless steel strips, gives only about 2% extra energy loss (fig.2, Type 7).

Even the mechanical fixings, used in many metal deckings, with bitumen paper as surface, can be calculated, and we find losses of around 10%.

Thus we find that thermal bridges are very important in metal construction. They give extra energy loss.

But they also cause low temperature at local points. This can cause condensation and concentration of dirt etc.

6. REFERENCES

- [1] SWEDISH STANDARD SS 02 42 30, K ldbryggor i pl tkonstruktioner-ber kning av v rmegenomg ngskoefficient (Thermal bridges in sheet-metal constructions - calculation of coefficient of thermal transmittance), Swedish Building Standards Institution. Stockholm, 1983.
- [2] JOHANNESON G,  BERG O, K ldbryggor i pl tkonstruktioner. Report TVBH-3006, Lund Institute of Technology, Div. of Building Technology, Lund 1981.
- [3] CARSLAW H S, JAEGER J C, Conduction of Heat in Solids. Oxford University Press, 1959.
- [4] VINBERG Hans A. The effects of thermal bridges and How to calculate thermal bridge factors, Alurama International, 1-1983, KORRUGAL, Finspong, Sweden.

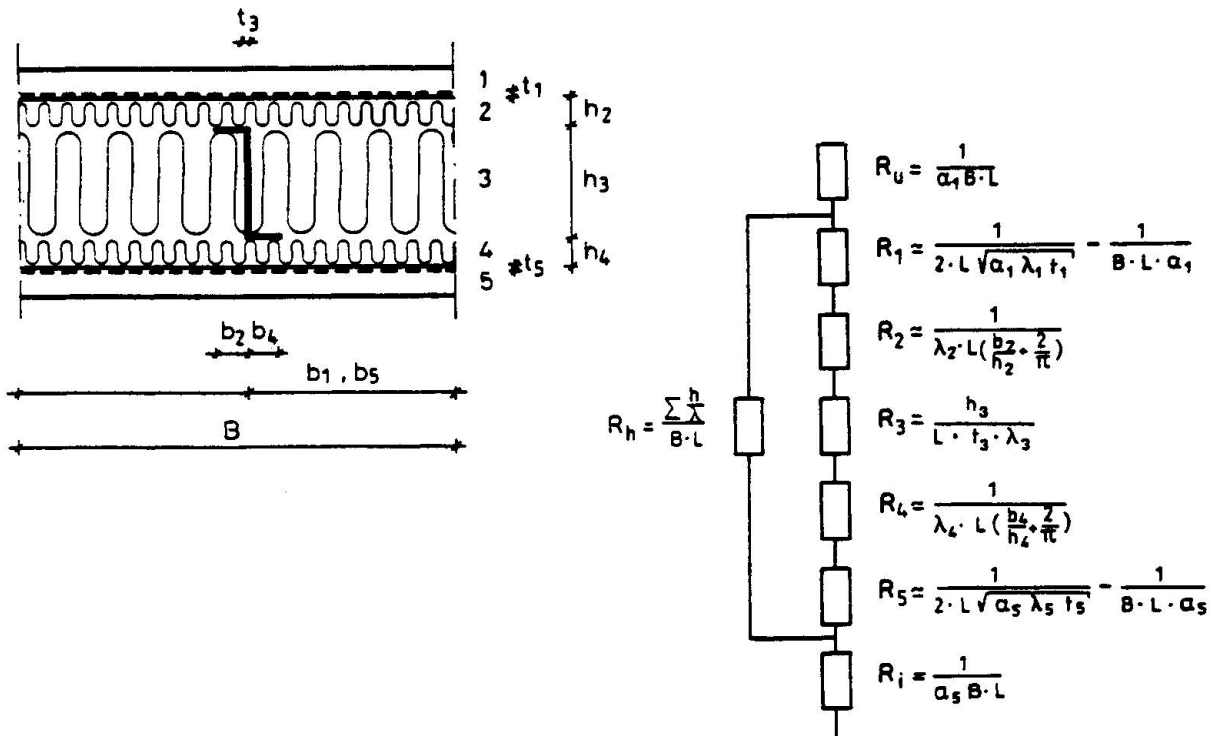
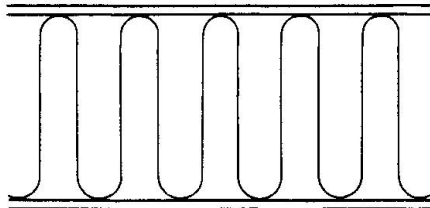
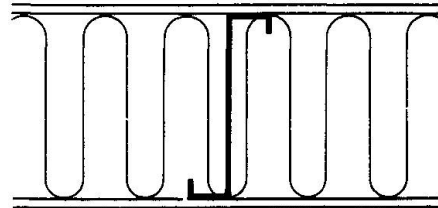

FIG 1. A generalized built-up sheet metal construction together with the corresponding resistance network.



Type 1. The U-value is 0.19 if there is no thermal bridge.



Type 2. The U-value rises to 0.33, an increase of 75%, if a lightweight steel spacer is used.

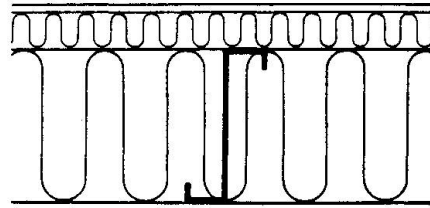

Type 3. The use of a layer to break the thermal bridge reduced the impairment of the U-value to 27%.

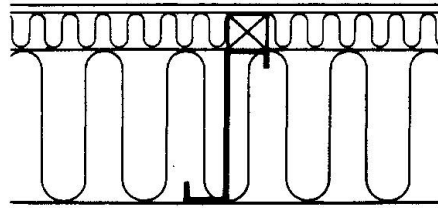

Type 4. A support against the spacer impairs the U-value to 43%.

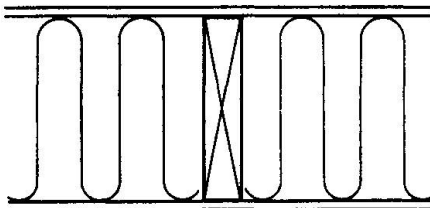

Type 5. A wood spacer impairs the U-value by 7%.

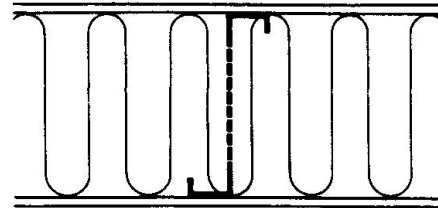

Type 6. A stepped spacer impairs the U-value by 15%.

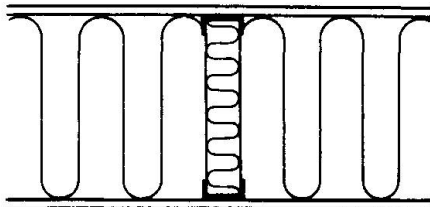

Type 7. A Korrugal insulation spacer impairs the U-value by no more than 1%.

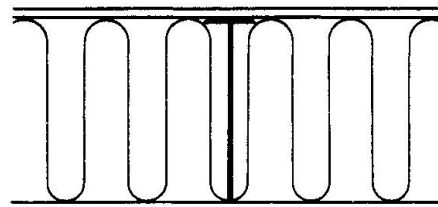

Type 8. Metal decking with a mechanical fixture impairs the U-value by 13%.

Fig. 2. Examples of different thermal bridges.

Effect of different thicknesses

| Type | U-value, W/m ² C | | | Impairment, % | | |
|----------------------------------|-----------------------------|------|-------|---------------|-----|----|
| | 200 | 100 | 50 | 200 | 100 | 50 |
| 1 Without coldbridge | .191 | .364 | .667 | 0 | 0 | 0 |
| 2 Steel spacer, c/c 2 m | .333 | .563 | .897 | 75 | 55 | 35 |
| 2 c/c 2, 1.5, 1 m (also for 3-7) | .333 | .630 | 1.133 | 75 | 73 | 70 |
| 3 Breaking layer 30 mm | .242 | .434 | .762 | 27 | 19 | 14 |
| 3 30, 23, 15 mm (also for 4) | .242 | .444 | .805 | 27 | 22 | 21 |
| 4 With support | .271 | .503 | .922 | 43 | 38 | 38 |
| 5 Wood spacer | .203 | .394 | .736 | 7 | 8 | 10 |
| 6 Stepped spacer | .219 | .438 | .874 | 15 | 21 | 31 |
| 7 KORRUGAL spacer | .193 | .371 | .687 | 1 | 2 | 3 |
| 8 Metal decking | .215 | .403 | .723 | 13 | 11 | 8 |

Condensation in Roofs with Thin-Walled Metal Sheets

Condensation dans les toitures avec tôles profilées en acier

Kondensation in Dächern mit dünnen Metallprofilblechen

Felix VAES

Civil Engineer
ESSA nv
Diest, Belgium



Felix Vaes, born 1956, received his civil engineering degree at the Katholieke Universiteit Leuven, Belgium. For almost 6 years he was involved in research concerning hygrothermal problems in roofs. At present he is co-manager of ESSA nv, a consulting firm specialized in low-energy technology and building physics.

Hugo HENS

Prof. Dr.
K.U.-Leuven
Leuven, Belgium



Hugo Hens, born 1943, received his civil engineering degree at the Katholieke Universiteit Leuven, Belgium. Doctor in applied sciences, 1975. Professor in building physics at the university since 1981. Involved in research on roof systems, energy use in buildings, a.o.

SUMMARY

The paper deals with condensation problems in roofs with thin-walled metal sheets. The buildings concerned covered a wide range of indoor climates ranging from storage buildings with very low moisture content to swimming pools.

RÉSUMÉ

Cette contribution traite des problèmes de condensation dans les toitures avec tôles profilées en acier. Les bâtiments concernés couvrent une gamme étendue de climats intérieurs: des dépôts avec faible degré d'humidité jusqu'aux piscines.

ZUSAMMENFASSUNG

Dieser Artikel behandelt Kondensationsprobleme in Dächern mit dünnen Metallprofilblechen. Die Untersuchungen betreffen Gebäude mit sehr unterschiedlichem Innenklima: von der Lagerhalle mit sehr geringer Feuchtigkeit bis zum Hallenbad.



1. INTRODUCTION

At several times during the past five years, we have been confronted with severe leakage, caused by condensation in roofs with thin-walled metal sheets. The damage varied from water dripping out of the roof, to degradation of preserved goods and deterioration of the roofing system. Problems occurred not only in buildings with a high vapour load, but also, as treated here, in buildings with a rather low inside vapour concentration. See also (1).

2. SOME CASE STUDIES

2.1. Cheese storage building

2.1.1. Construction.

The building consisted of two large storage rooms, both with walls and ceilings of sandwich-panels 'steel-PU-steel', the joints between the panels were sealed with a PVC-packing. The roofs were covered with metal sheets, the loft space between ceiling and sheets being ventilated with outside air: figure 1. Both cheese storage rooms were conditioned, one at 6°C and 90% R.H., the other at 12°C and 90% R.H.

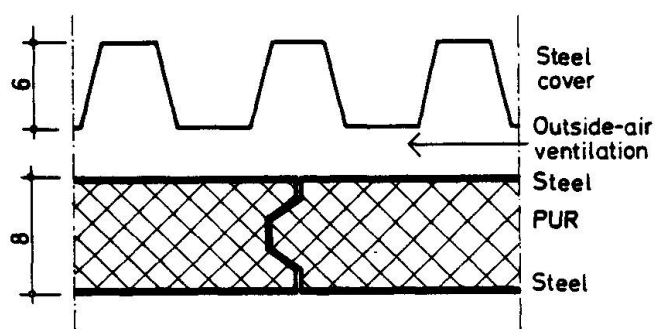

Fig. 1.

2.1.2. Damage.

In the loft spaces above both rooms (fig. 1) there was severe surface condensation against the metal sheets. The water, dripping on the ceiling, penetrated the joints between the sandwich-panels and damaged the stored cheese.

2.1.3. Causes.

By long wave radiative losses to the open sky, the night-time surface temperature of a roof may drop 6 to 10°C below air temperature. Having a very low thermal resistance and inertia, the underside temperature of the sheets equals the upside value. So, each time the outside surface temperature falls under the outside dewpoint, condensation goes on, not only at the sheets outside surface but also

- as far as the loft space is ventilated with outside air
 - or/and a vapour transport by convection/diffusion exists from the inside to the roof space,
- at the sheets inside surface.

In the case of the cheese storage building, convection of vapour to the loft space was very likely: there was an overpressure in both rooms, and the ceiling wasn't airtight. Otherwise water penetration through the joints wasn't possible! With that reality in mind, condensation against the inside sheet surface was a fact, each time the temperature of the sheets dropped below 10°C, the dewpoint of the air in the 12°C-room. A sheet temperature lower than 10°C is, considering the Belgian climate, possible each season. Because of lack of capillarity of the metal sheets, dripping begins shortly after the condensation starts.

2.1.4. Solution.

Here, it was necessary

- to raise the inside surface temperature of the covering;
- to reduce the vapour transfer by convection;
- to improve the capillary suction of the coverings inside surface.

This was realised by

- spraying, at the inside of each room, an elastic air- and vapourtight layer against the sandwich-panels;

- putting a new roof on top of the loft space, composed of an inside capillar cement bound fibre board, a vapour barrier, thermal insulation and an outside metal sheeting.

2.2. Sugar terminal

An immense hall ($\sim 300.000 \text{ m}^3$) for sugar storage, was built with load bearing wooden arches, the outside walls and roof composed of an inside PU-board, vented air space and an outside thin metallic sheet cladding (fig. 2). The PU-boards were mounted very carefully, as to realise an air- and vapourtight inside leaf and ceiling. The vapour load of the inside air was rather low:

$$\theta = 15 - 25^\circ\text{C}$$

$$\text{RH} = 30\%$$

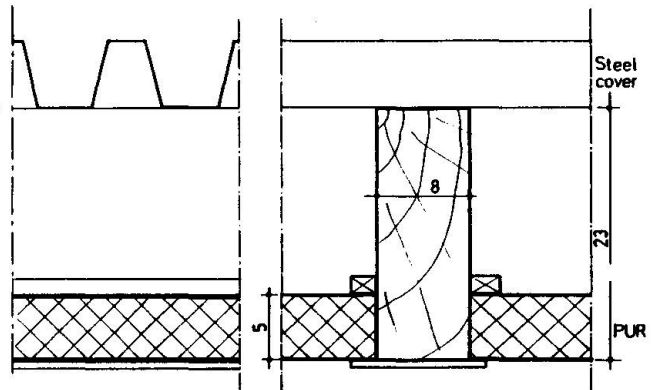

Fig. 2.

2.2.2. Damage.

Water drips out of the roof at several places, causing damage to the sugar.

2.2.3. Cause of the damage.

To avoid dust penetration from the outside, the storage building must always be in overpressure. Therefore 25.000 m^3 of fresh air is blown through the sugar into the hall, after climatisation. The only way-out is the ceiling that isn't airtight, in spite of the good workmanship. That was clearly observed by endoscopic control, white dust (sugar) floating in the vented air space between PU-boards and sheeting. The reality of condensation was observed during a cold winter period, when ice was formed against the sheeting in the air space. During the following thawing period, the ice melts, giving dripping water. Calculations, using the measured climatic data, showed that the amount of condensate raises from $0,1 \text{ gr/m}^2\text{h}$ without airflow (diffusion only) to $20 \text{ gr/m}^2\text{h}$ with the measured airflow. Because of long wave radiation and, coupled, the sheetings temperature drop, the problem may appear each season.

2.2.4. Solution.

A very important financial claim for each day the terminal would be out of use made it impossible to empty the building. Therefore, after sealing all joints between the existing sheets, a new roof was built over the old one, using a PU-thermal insulation and a new metal sheet covering. The extra thermal insulation was taken thick enough to be sure the temperature of the old sheet would always be higher than the dewpoint of the inside air. Because of the increase of the airtightness of the building after the retrofit, it was also necessary to change the air-conditioning.

2.3. High school

2.3.1. Construction (fig. 3).

The roof of the entrance hall and restaurant of a high school were constructed as indicated in fig.3:

- perforated steel sheet;
- acoustical insulation: mineral wool (2,5 cm);
- thermal insulation: mineral wool (8 cm);
- aluminium sheet.

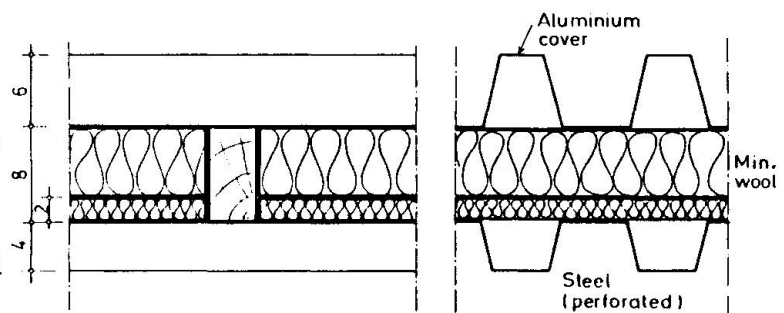

Fig. 3.



Slope: 27°
Orientation: NW

2.3.2. Damage.

In wintertime, several times, water dripped out of the roof.

2.3.3. Cause of the damage.

In Belgium interstitial condensation usually is calculated with monthly mean climatological data. This is justified, because of the hygric inertia of most constructions being high enough to blot out peaks in moisture production. However, here, because of the non-existing thermal and hygric inertia of this roof, the momentaneous temperature and vapour pressure situation becomes important. For that reason, the vapour production of 200 students in a hall of 3.000 m³ is large enough to cause, after some hours, transient interstitial condensation against the alu-sheets. When the temperature of these stays lower than 0°C for several days (frost or long wave radiation), in view of the lack of absorption of the sheets severe leakage problems may occur during thawy weather.

2.3.4. Solution.

A vapour barrier was built in between the two insulating layers. This experience once again proved that the thermal and acoustical function of a ceiling, should be separated.

3. CONCLUSIONS

The examples and theoretical reflections show three parameters, which play an important role in condensation problems with light-weight, metal sheeted roofs:

- lack of airtightness of the ceiling, especially when the building is in over-pressure, with, as a result, a 'moist' air flow from the inside of the building to the roof space;
- negligible thermal resistance and inertia of the metal sheets, coupled to a very low outside surface temperature, caused by long wave radiative losses to the open sky;
- absence of capillarity of the metal sheets.

Many problems may be solved using sandwich-panels with a core of foamed insulation. However, attention has to be paid avoiding thermal bridging at the edges. Also the vapour and air tightness of the joints should be studied carefully.

(1) LABORATORIUM BOUWFYSICA, K.U.-Leuven, Condensatieproblemen (in Dutch), unpublished, 1981-1985.

Field Coating of Existing Thin-Walled Metal Structures

Revêtement de protection in situ des constructions en acier à parois minces

Beschichtung von bestehenden dünnwandigen Metallkonstruktionen

Stanley M. COTHREN

President
S. M. Cothren & Assoc., Inc.
Shreveport, LA, USA



An Engineering graduate of Louisiana State University, USA, S.M. Cothren has been active as a Consulting Civil Engineer on a wide variety of civil projects since 1958. An important area of his practice has been in the inspection of various steel structures and tanks, followed by the preparation of detailed specifications for each individual project.

SUMMARY

An overview of the re-coating requirements and methods for restoring and maintaining the useful life and integrity of thin-walled metal buildings is given in a summary form. This paper is designed to serve as a general guide to the industry accepted procedures for various work activities in the recoating process. The activities covered herein are surface preparation, material selection and coating application.

RÉSUMÉ

Cette contribution donne un aperçu des conditions à requérir lors de l'application d'un nouveau revêtement et des méthodes de restauration et d'entretien à appliquer pour maintenir une construction en tôle mince formée à froid dans sa longévité et son intégrité. Son but est de servir de guide sur les procédés acceptés par l'industrie pour les différents travaux entrant dans le processus de rénovation des revêtements. Il s'agit en particulier de la préparation de la surface, du choix des matériaux et du mode d'application.

ZUSAMMENFASSUNG

Eine Übersicht über Anforderungen und Methoden für die Wiederherstellung und Erhaltung der Beschichtung von dünnwandigen Metallkonstruktionen wird in knapper Form gegeben. Das Dokument ist als allgemeine Richtlinie für die von der Industrie akzeptierten Methoden bei der Beschichtungserneuerung entworfen worden. In dieser Übersicht werden Oberflächen-vorbereitung, Materialauswahl und Anbringen der Beschichtung behandelt.



1. INTRODUCTION

Beginning in the mid 1940's, metal building systems that were pre-formed and shop coated have made tremendous and impressive advancements in the building construction industry. The earliest memory most of us have of a pre-fabricated metal building is the Quonset huts used in World War II, some of which are still in existence today.

Advancements to this date in the industry give the buyer hundreds of choices in panel profiles, materials and coatings to choose from, and because of this, the thin-walled metal structure is seen in the use of thousands of different commercial and industrial applications from warehouses and schools to power plants and the petrol industry. With this advancement in uses, the need to understand the many coating systems is very important to the retro-fit industry, as well as the Architects and Engineers responsible for evaluating the need for, and method of, recoating these thin-walled metal structures.

The specifier must have a good general knowledge of metal structures, factory coatings, and proper methods of preparation for recoating with compatible materials.

2. DURABILITY

The most important characteristic of all building components is durability, which is defined as; the ability of the unit to meet or exceed a projected life span. Durability is very critical for thin-walled metal structures as the basic metal component usually range in thickness from 18 gauge to 26 gauge.

2.1 Thin Wall Materials

The metal in the structure can be copper, several types of steel and aluminum, to name the predominate ones. Each has specific areas of use and not all metals are suited to all environments. The most common preformed raw material is steel, and because of the inherent nature of steel to deteriorate from reaction with the elements, a proper coating, properly applied is the key to durability.

3. FACTORY COATINGS

3.1 Development

As a part of the manufacturing process, a factory coating is applied to the thin metal component. These systems are as old and varied as the base metal component. In the Quonset hut era, galvanizing was the industry standard. To improve appearance and marketability, red-lead primers on steel with colored enamels as the final coating were developed. These coatings were surpassed by the use of urethanes, epoxy systems, silicone polyesters and now various forms of acrylic films (polymers). The latter is the popular "sheet" bonded to the metal prior to fabricating.

3.2 Observations

The owners of thin-walled metal structures should regularly observe the appearance and the condition of their structure to determine when deterioration begins. The earliest and most commonly detectable sign of coating breakdown is a process known as chalking. Chalking is primarily caused by ultraviolet breakdown and appears as a thin layer of powder-like pigment on the structure's exterior surface. At the appearance of chalking or any sign of blistering or pitting, the owner should secure an inspection by a qualified professional.



4. INSPECTION

4.1 By Whom

An inspection of the thin-walled building should be done by a qualified Architect or Engineer, that is familiar with coatings and their application.

4.2 General Procedure

The inspection should cover all parts of the thin-walled structure, with particular emphasis on exterior wall condition. The inspector should note all defects, the assumed cause, and the extent of the problem.

4.3 Report to Owner

The inspector should give the owner a detailed report on each part of the structure and the assumed reason for the defects or breakdown in the coating system.

4.4 Responsibility of Owner

The type of factory coating should be made available to the inspector to assure compatibility of paint systems. The inspector should also be given data on the thickness of the metal panels, so he can properly specify the method of surface preparation compatible to the metal.

5. SELECTION OF RECOATING MATERIAL

5.1 Review

Other than galvanized, aluminized and galvalume systems, there are three other standard organic finishes used by the metal building industry. Proper selection of a new coating system is the first and most important step in assuring a successful re-painting project. Along with compatibility, the other important thing to address is the environment in which the building is located, and the specific atmospheric elements that may attack the new system. A brief overview of paints compatible to factory coatings follows:

5.1.1 Aged Galvanized Surfaces

The most compatible material for this type of surface is an oil-cementitious, prime coat system. These primers have excellent wetting ability and low surface tension that gives good penetration. Longer oil lengths should be selected because of increased flexibility and durability. This primer would be top-coated with an acrylic.

Another acceptable retrofit system is the use of urethane primers, that are aluminum-pigmented, followed by an acrylic polyurethane enamel.

5.1.2 Factory Applied Acrylics

After proper preparation it is recommended that moisture cured urethane primers be used, followed by an intermediate epoxy-polyamide coating and then a final coating of acrylic polyurethane enamel.

5.1.3 Factory Applied Polyester

There are two common systems that will adapt satisfactorily to older polyesters. One is a moisture cured urethane primer followed by an intermediate epoxy-polyamide coating and then a final coating of acrylic polyurethane enamel. A second and excellent system is an epoxy-polyamide primer followed by an aliphatic polyester polyurethane enamel.



5.2 Material Capabilities

In selecting the proper material from the above group, it is essential that the environment be considered in order to give longer life to the recoating system. The specifier must have a good knowledge of the generic types of primers and topcoats in order to match the durability of the system to the known or anticipated environment.

5.2.1 Primer Selection

The oil cementitious primer compatible with aged galvanized surfaces affords excellent wetting, and penetrating ability. It is excellent for fresh or salt water environments, but limited in life in environment containing inorganic acids, alkalies, gases and solvents. The moisture cured urethane primers are more protective in the latter environments, except for sulphur gases. Both primers should be followed by a compatible topcoat.

5.2.2 Intermediate and Topcoat Selection

In the enamel type line, excellent protection against severe environments can be obtained through the use of acrylic urethanes. These two-component urethanes have high initial gloss and excellent gloss retention. However, this material is subject to deterioration when exposed to chlorine gas and some refinery crudes.

Except for older acrylic surfaces, the new polyimide epoxies are ideal for intermediate coats when harsh environments prevail. One thing that makes this material ideal for metal buildings is its ability to bond well and still be flexible enough to resist dimensional temperature changes.

A really superior final coat, either glossy or semi-glossy can be obtained through the use of polyester polyurethane enamel coatings. This two-part material of ethylene glycol, ethers and ketones in the first part, is mixed 2:1 with high solids aliphatic polyisocyanate, acetates and solvents. This coating is highly resistant to wet conditions, corrosive fumes and chemical contact. This is also an ideal topcoat for restored, primed galvanized structures.

6. SURFACE PREPARATION

6.1 The Key to Success

The importance of surface preparation is fundamental to all recoating applications, because one of the major contributing factors of coating failures is poor surface preparation. The applied coating is no better than the surface on which it is applied. For recoating of metal structures, all dirt, grease, rust and any non or poorly adhering factory coats must be removed, followed immediately by one of the above recommended primers. The specifier is certainly responsible for detailing the surface preparation in his specifications, and assuring the owner that the specifications are followed.

6.2 Preparation Methods

Preparation methods done prior to recoating of metal buildings vary with the selected coating, the environment and the type and condition of the original material. Several methods have been established by the "Steel Structures Painting Manual, Vol. 2." However, it has been found that there are four basic methods that are best suited for use on thin-walled metal structures.



6.2.1 Solvent Cleaning

Solvent cleaning is classified as SSPC-SP1 and specifies the removal of all dirt, oil, grease and foreign matter, as well as chalking (powdery pigment) by the application of commercial solvents and cleaners. Although wiping is mentioned in the specification, power wash or steam cleaning are the most efficient and complete methods.

6.2.2 Hand Tool Cleaning and Power Tool Cleaning

Hand tool cleaning (SSPC-SP2) and power tool cleaning (SSPC-SP3) are exactly what the term implies and usually follow a good solvent cleaning. However, these methods are not totally adequate for surface preparation where exposure will be moderate to severe, and they do not completely prepare the surface for recoating of acrylics, polyesters or siliconized polyesters.

6.2.3 Commercial Blast Cleaning

The commercial blast cleaning method, (SSPC-SP6) requires the removal of at least two-thirds of all original paint, all visible rust and other foreign matters. This is done by use of compressed air nozzle blasting at a 520 kPa (75 psi) pressure. This method must be used where existing paint has deteriorated and is usually adequate for most surfaces.

6.2.4 Brush-Off Blast Cleaning

The brush-off blast cleaning process (SSPC-SP7) calls for the removal of loose rust, paint and foreign matter. This method, which is always preceded by solvent cleaning is found to be best for extremely thin metal walls in ranges from 24 to 26 gauge, but is not good in areas of severe environments.

Because the blast cleaning methods are the most popular, I would like to note some specific areas to observe. For galvanized surfaces, it is extremely important to check all seams to insure that rust has been removed and to replace any rusted bolts or clips, cleaning the openings, as good as possible. One should apply the selected prime coating immediately after cleaning and brushing. For old acrylic or polyester coatings, all loose, chalked or cracked areas must be removed, and any painted areas remaining should be clean and tightly bonded to the metal. It will sometimes be necessary to follow guidelines for "Commercial" and "Brush-off" methods on a single structure. "Brush-off" is usually adequate when fascia flashing overlaps deep ribbed panels.

Where the sheet steel is badly deteriorated and pitted, blasting should not be severe. Some areas will require the care of hand tool cleaning. These variations should be noted in the Engineer's inspection and stated specifically in the specifications.

6.4 Abrasives

The selection of abrasive material is critical because it is a prime factor in creating a good "surface profile" that permits adhesion but does not exhibit exposed peaks. The abrasive material must be kept clean and free of oil and moisture. This is necessary to secure a sharp angular profile that affords a good bonding surface. For recoating, the sharp, hard silica sand abrasives are recommended, as they are not generally recycled, and the material is clean and dry.



7. APPLICATION

7.1 Specifications

In establishing proper application procedures the specifier must consider a number of important and related factors to secure the best finish on a properly cleaned and prepared surface.

7.1.1 Brush

In general, most paint coatings can be applied by brush, roller or spray equipment. However, it is considered better painting practice to apply the first coat of paint to any surface by brush. Primers or pre-treatments on metal should be applied by brush or brush and roller when wind conditions dictate. Under certain conditions, wind velocity above 24 km/h (15 mph) can cause material loss, inadequate film build, overspray and dry spray where air sprayers are used. Generally, greater care in application must be exercised to insure proper spread and application to all depressed areas and seams. This requirement should be foreseen by the specifier, and noted in the specifications.

7.1.2 Air Spray

Most paint manufacturers will note the specifics for spray applications (air or airless). However, the guidelines should be noted in the specifications and wind limitations set forth in a firm manner. Where spray application is used, the Engineer should definitely check the wet and dry film thickness at regular intervals and control the work under windy conditions.

7.2 Product Preparation

Most high solid coatings will settle in storage. Proper mixing is necessary to redistribute the solids before using. Thinning is required in some instances, but this should only be done if the manufacturer recommends thinning. It is also important to use only thinners recommended by the coating manufacturer.

In the case of epoxies or other two-component materials, it must be remembered that such materials have a limited pot life once the two components have been mixed together. It is important that the specifier know the pot life of such materials, and that he does not allow the mix of more material than can be used in the prescribed time. Applying materials that have been allowed to sit around for more than the allotted pot life will result in poor adhesion and/or complete failure.

7.3 Environmental Conditions

Due to the large surface area of most metal buildings, and because the exterior surfaces are most often recoated, the environment is very important. All coating manufacturers furnish data on temperature and humidity parameters. A minimum and maximum is usually given and for most primers is 4°C (40°F) to 49° C (120°F). Finish coatings of epoxy and acrylic polyurethane are the same. However, most epoxy base coatings have a lower limit of 10°C (50°F).

7.4 Test Patch

Prior to coating a structure, it is highly recommended that a test patch of primer and then intermediate or final coating be applied. With this test patch, adhesion can be checked to assure compatibility of all components.



7.5 Coating Thickness

Each type of coating manufactured has a recommended wet and dry mill thickness that should be followed. This film thickness is expressed in mils. The inherent resistance characteristic of any coating to various environmental influences determine the total mil thickness that should be achieved with a certain coating system.

7.5.1 Paint Solids

The non-volatile content of a coating is the solids portion, which is that part of the whole coating which will remain on the surface, once the solvents evaporate. In attempting to obtain a certain coating thickness on a structure, it is most desirable to achieve this with a multiple-coat system. Hence the primer, the intermediate coat and the finish coat.

8. CONCLUSION

In concluding this paper, the author wishes to express appreciation for technical assistance from the TNEMEC Company and call to the attention of owners and coating specifiers the extreme importance of selecting coatings compatible to the building surface material, making sure the surface is properly prepared and the environmental compatible product is applied with care and thorough attention to details.

Leere Seite
Blank page
Page vide

Stiffness Criteria and Dynamic Serviceability of Light-Weight Steel Floors

Critère de rigidité et comportement dynamique en service de planchers légers en acier

Steifigkeitskriterien und Schwingungsverhalten unter Gebrauchslasten von leichten Deckenkonstruktionen

Sven OHLSSON

Dr. Eng.
Chalmers Univ. of Technology
Gothenburg, Sweden



Sven Ohlsson, born 1952, received both his civil engineering degree and his doctoral degree at Chalmers University of Technology. His research work has been focused on structural problems for buildings and bridges and especially dynamic ones. He is presently the manager of several research projects within this area.

SUMMARY

Cold-formed thin-walled members and trapezoidal steel sheeting are frequently used for walls and roofing today. The use of such components in floor structures will require special detailing and design for dynamic footstep loading to ensure good serviceability. Floor springiness and vibration behaviour is analyzed. Proposed design parameters and their interpretation are described. Specific problems related to thin-walled elements such as low local rigidity are discussed.

RÉSUMÉ

Les profilés minces formés à froid ainsi que les panneaux de tôle trapézoïdale sont de nos jours fréquemment employés dans la composition des parois et toitures. L'utilisation de tels composants dans les planchers requiert une conception et un dimensionnement particulier pour un cas de chargement dynamique produit par une personne qui marche sur ce plancher, et ce, afin d'assurer une bonne aptitude au service. Le comportement vibratoire du plancher ainsi que sa souplesse sont analysés. Suit une description des paramètres proposés pour une étude détaillée, ainsi que leur interprétation. Des problèmes spécifiques aux profilés minces, comme par exemple la faible rigidité locale, font l'objet d'une discussion.

ZUSAMMENFASSUNG

Kaltgeformte dünnwandige Profile und Trapezprofilbleche werden heute sehr oft für Wände und Dächer verwendet. Wenn eine solche Bauweise für Decken gewählt wird, muss bei der Gestaltung und bei der Berechnung auch dynamischen Lasten von Fussgängern Rechnung getragen werden, um eine gute Gebrauchsfähigkeit zu gewährleisten. Die Elastizität und das Schwingungsverhalten von solchen Decken ist untersucht worden. Vorgeschlagene wichtige Parameter für eine derartige Konstruktionsberechnung werden beschrieben. Besondere Probleme solcher Elemente, wie die örtlich geringere Steifigkeit, werden diskutiert.



1. FLOOR VIBRATION AND SERVICEABILITY

1.1 Introduction

The limitation of springiness and floor vibrations is often governing the design of light-weight floors. For residential and office buildings the dynamic footstep load from people in motion is the most difficult one to handle at the design stage since this kind of load is likely to occur at any position. Consequently design for footstep loading concerns all parts of the floor structure, whilst for instance the design for dynamic machinery loads may include local stiffening, resilient mounting etc.

Traditionally excessive floor vibrations have not been a major concern to the design engineers. Very often good vibrational response has been believed to be achieved only by ensuring a certain stiffness due to a distributed load, e.g. deflection from a distributed load has been limited to a certain fraction of floor span. There are many examples showing that this is not necessarily sufficient.

Since floor vibration is very likely to occur in light-weight structures with low local rigidity and with a pronounced orthotropy with regard to bending rigidity, light-gauge steel floor structures unfortunately are candidates for being 'problem floors' if no special care is taken by the designer. In other words; when thin-walled cold-formed members or sheeting are to be used in floor structures one has to forget about strength (which of course must be checked in the end) and start the design process by creating a stiff structure with respect to a concentrated dynamic force at an arbitrary location.

The acceptable floor vibration level is usually determined by human sensitivity to vibration, but sometimes also by sensitive equipment like computers etc. Human sensitivity to vibration depends on a large number of parameters. The dependence of time is very strong, which means that short-term strongly damped vibrations may have many times higher amplitudes than stationary, continuous vibrations and still be rated as being less disturbing. The activity of a disturbed person is also crucial. A walking person accepts much larger vibrations than a person who is reading a paper.

1.2 Engineering interpretation of footstep induced vibration problems

Complex problems of the actual kind must be substantially reduced and simplified in order to achieve a more clear picture of the governing relations. This is the background to the following somewhat simplified description of selected relations and properties involved in footstep induced floor vibrations and their disturbing effects on people.

The contact force from a walking person is illustrated in fig.1. As can be observed this force can be characterized as a stationary dynamic force of the broadband type provided that the horizontal walking velocity is assumed to be small. However, the time history also contains impulsive parts of a more transient kind as well.

The frequency distribution tells that the major part is low-frequent (<6 Hz) and above 6 Hz the force intensity decreases inversely proportional to the frequency.

The impulsive parts of common footstep force time histories as well as forces from occasional jumps are to be considered as impacts. The structural response to impact load can roughly be said to be inversely depending on the structural mass activated. A high transverse bending rigidity enables a larger floor area (and mass) to participate in the initial impact response.

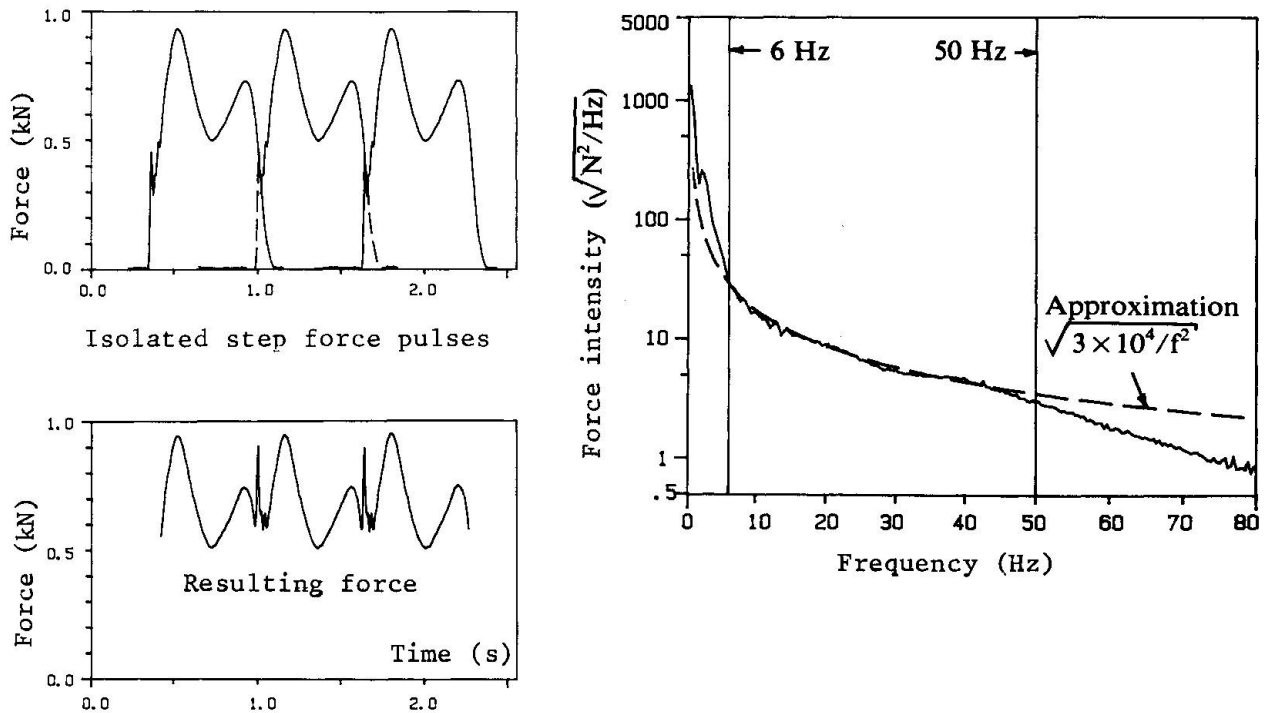

Figure 1 Footstep force time histories and force intensity (= square root of spectral density). After [4].

Typical joist floor structures are of the one-way type, which means that they are strongly anisotropic. This is not a good property since it leads to a large number of closely spaced resonances. Most floors can be modeled as grid systems for static and dynamic analysis. Fig.2 shows static deflection and eigenmodes together with a flexibility plot for a joist floor.

Several conclusions can be made from the properties illustrated by fig.2. Firstly, the common approach to civil engineering dynamic problems, that it is sufficient to consider the fundamental mode only, seldom applies to this kind of structures. Secondly, an increase of the transverse bending rigidity of joist systems is often more effective than an increase of joist depth. The third conclusion is based on the force spectrum in fig.1 together with the flexibility frequency function in fig.2; If possible the fundamental frequency of a floor structure shall be chosen essentially higher than the upper frequency limit of the major force components (≈ 6 Hz). This means that the calculated lowest eigenfrequency should be at least 8 Hz for an unloaded floor. Although this cannot be achieved for very long-span floors, most light-weights floor structures can meet this demand.

Modal relative damping c/c_{cr} is most important for floor vibrations but it is usually not controlled by the design engineer. Experimentally determined values for c/c_{cr} vary approximately between 0.6% and 1.6% for laboratory floor specimens, but values up to 5 to 10% occur occasionally for floor structures in finished buildings. Although damping in finished buildings shows very large scatter one should be slightly suspicious to the very high damping values that sometimes are presented. Damping is a good property in two different ways; it reduces the vibration amplitude from stationary loading and it reduces the duration of large amplitudes after an impulsive load.

The human response to vibration is a complex matter. Two facts are the most important ones here. The human response to *sinusoidal* excitation is believed to be equally severe if the vibration *velocity* amplitude is the same, provided that the



frequency of the sinusoid is higher than 8 Hz. For lower frequencies, vibration acceleration seems to be a better measure on the disturbing effect. The human response to *impulsive* vibration is known to be heavily dependent on the decay rate. In other words, an initially larger vibration can be rated as less severe if the decay rate is higher.

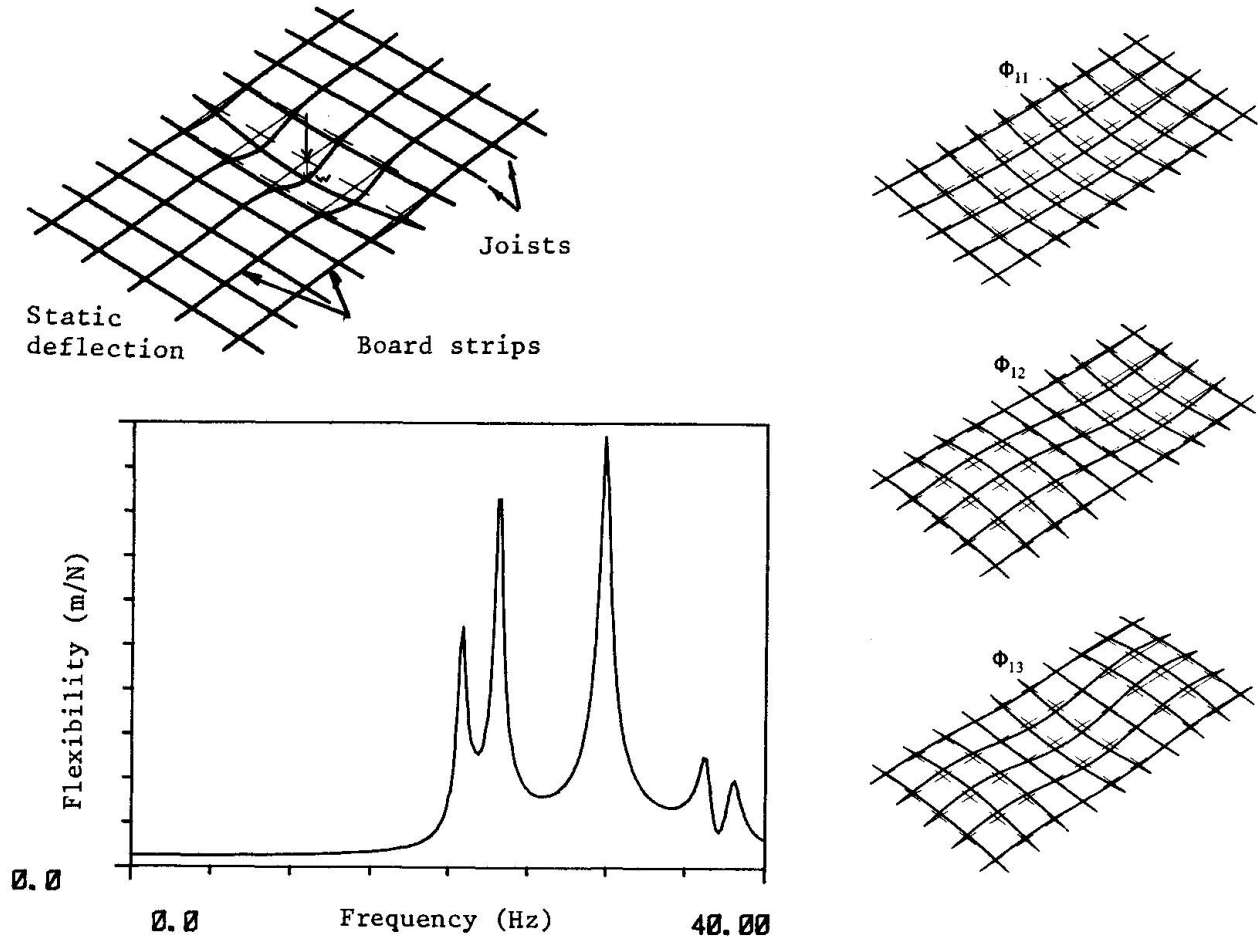

Figure 2. Typical "one-way" joist floor properties: Static deflection shape, frequency-dependent flexibility and corresponding mode shapes of vibration.

2. PROPOSED DESIGN METHOD

A procedure for the design of floors with respect to springiness and footstep induced vibration has been presented in [5]. The method applies to floors with a fundamental frequency ≥ 8 Hz and it is material independent. The design procedure is relatively simple to use because several design aids (flow-charts, diagrams etc) are provided. It is, however, outside the scope of this paper to describe it in any detail. Only the design parameters and their interpretation will be mentioned here.

The proposed design parameters to be calculated are the following:

- Static deflection w from a concentrated force = 1 kN
- Initial impulse velocity response h'_{\max} from a unit impulse = 1 Ns
- Damping coefficient $\sigma_0 = (c/c_{cr}) \cdot f_1$
- Stationary vibration velocity w'_{RMS} from the force spectrum in fig.1

The static deflection (a) should preferably be related to the most pliant location, typically at midspan between two joists. The initial impulse velocity response (b) is illustrated in fig.3. This quantity should be rated together with the damping coefficient (c) according to the same figure. The damping coefficient σ_0 is a somewhat odd damping parameter. The reason for using it here is that it provides a measure of the decay rate with respect to *time* regardless of the actual frequency and that this is relevant for the human response.

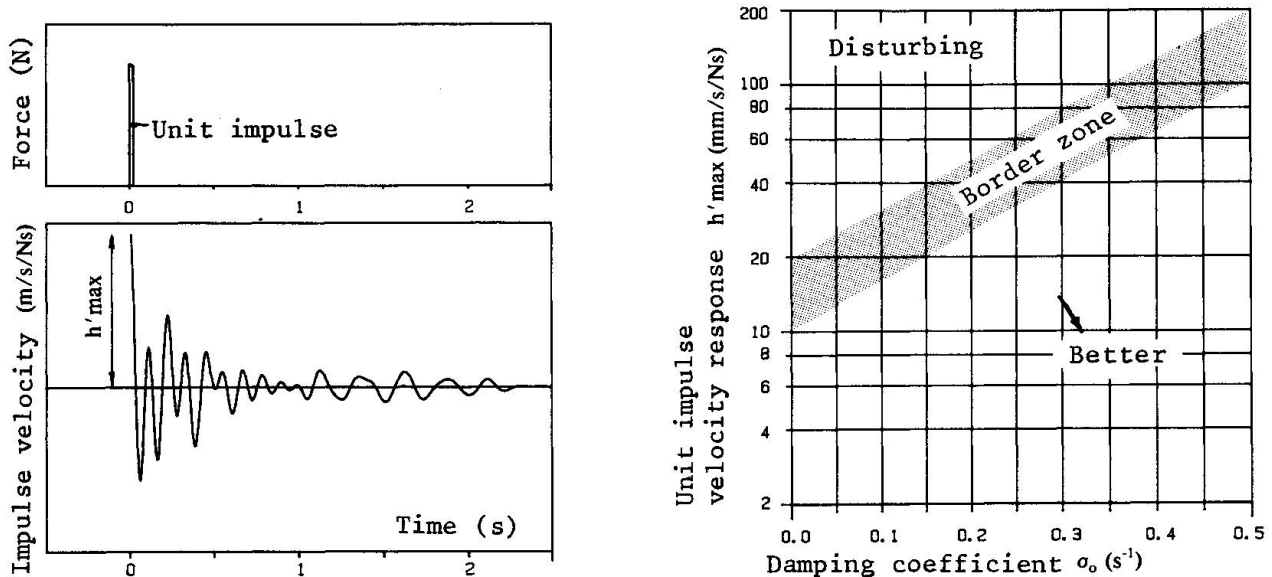

Figure 3. Illustration of impulse velocity response (left) and diagram for rating of floor impulse response (right).

The vibration velocity (d) is a calculated RMS-value for the vibration velocity generated by a dynamic stationary force with footstep force spectral properties as shown in fig.1.

The interpretation of the different design parameters should briefly be that the parameters (a), (b), and (c) together govern the degree of springiness and susceptibility to impulse vibration while parameter (d) is a measure of the severity of continuous vibration from more enduring pedestrian load.

3. STEEL FLOOR TYPES AND PROPERTIES

3.1 Overview

Steel floors can be divided into different groups with respect to the different kinds of structural components used. The following categories may be used:

1. Main structure consisting of hot rolled beams and welded girders supporting pre-fabricated concrete elements.
2. Composite structures with concrete slab cast on site on top of trapezoidal steel sheeting.
3. Trapezoidal steel sheeting supporting "dry" flooring of some kind, e.g. chip-board or plywood.
4. Cold-formed steel joist systems supporting the same kind of dry flooring.

The first type is today the most common one in Sweden. The second kind is very common in many different parts of the world and [1] gives an excellent guide to the subject.



The floor types 3 and 4 are not common yet. There is, however, a great interest in Sweden for such light-weight structures and this paper is mainly directed to them as well. In order to facilitate, floors of group no.3 will be called "trapezoidal floors" and those in group No.4 "joist floors". Joist floors are for instance treated in [2] and [3]. Trapezoidal floors are rarely found in the literature. The author has, however, been involved in the development and testing of a couple of such floor systems. One example is mentioned in [4] as specimen "TRP".

3.2 Light-gauge trapezoidal and joist floor properties

The global characteristics of these cold-formed floor structures are comparable to the properties of light-weight joist floor structures of other materials, e.g. timber and plywood beam systems etc. The properties which are special for cold-formed members are to be found within the areas of local flexibility, flexibility of joints and the stiffness of mechanical fasteners. The lack of high local rigidity of many cold-formed members originates from the fact that they have usually been developed to carry as large *distributed load* as possible. Another reason is that the cold-forming technique does not permit sharp angles of the member cross section.

Two facts about footstep induced deformations of a floor structure are essential here. The vertical deflections of the floor surface are very small. In the vicinity of the foot, deflections of the order 1-3 mm usually occur. In other areas smaller deflections occur both *upwards* and downwards. The size of these smaller distributed deflections are governing the dynamic stiffness experienced by a walking person. This distributed deflection pattern is composed by the different excited mode shapes together and is most important. Considering the fact that many areas of residential and office floors are practically unloaded (open spaces), the conclusion must be that the relevant stiffness value for a given member or joint is the very *initial stiffness in either direction*, c.f. fig.4.

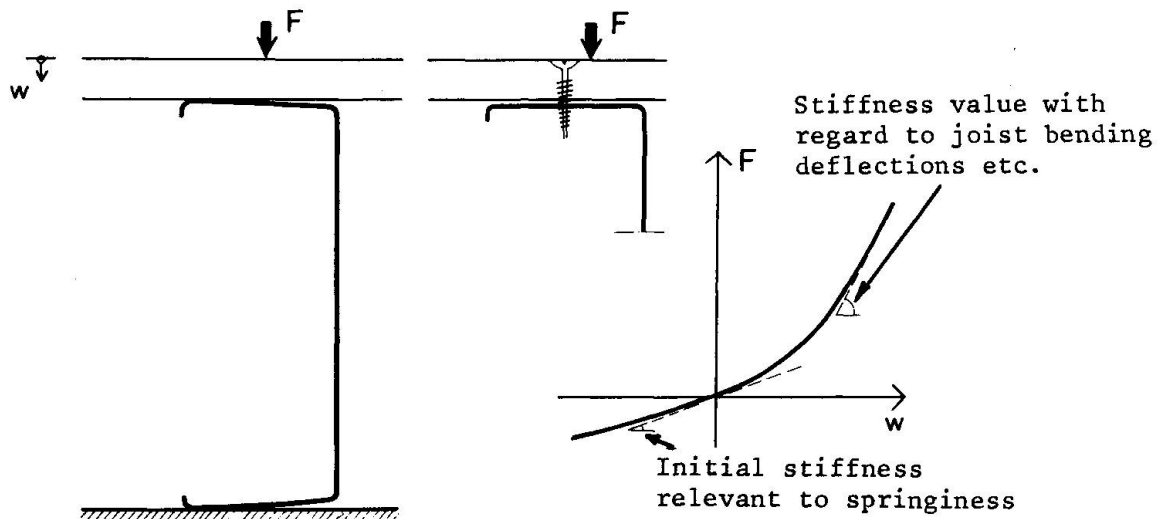

Figure 4. Illustration of low initial rigidity due to flange plate bending or bad function of self-tapping screws. F = force, w = deflection.

In fact there are numerous joint types which may show low initial stiffness, especially when considering that the dynamic forces sometimes are directed upwards. One must also bear in mind that the ceiling mass, e.g. from gypsum boards etc, may be quite large and to avoid internal low-frequency resonances the ceiling must be relatively rigidly fastened to the floor structure.

Some of the rigidity problems may of course be avoided by local stiffeners. Fig.5 illustrates some unconventional methods for such stiffening. They may serve as an inspiration for the development of new components which ensure highly rigid per-

formance for cold-formed structures. Such development is badly needed.

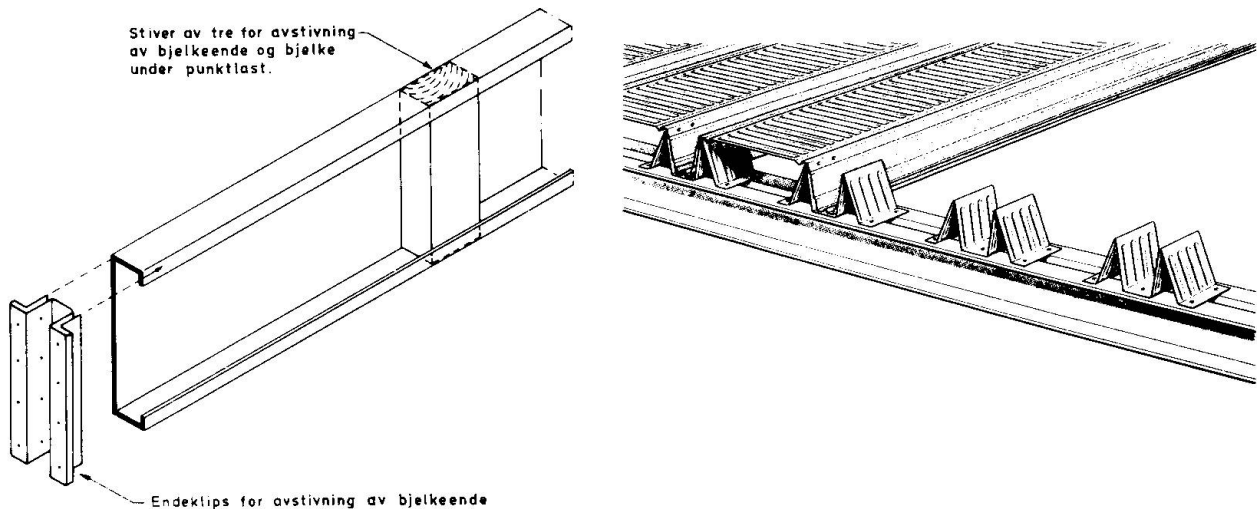

Figure 5 Example of local stiffeners (after [2]) and trapezoidal steel sheeting (PLANNJA) occasionally used as floor structural element.

4. CONCLUDING REMARKS

The use of trapezoidal and joist floors will be more dependent of different serviceability limit state properties than of load bearing capacity. Generally speaking, a structure which has been optimized with respect to one specific task usually will be malfunctioning in another situation until a re-design has been carried out. This should be taken as a challenge, which hopefully results in the development of thin-walled steel floor structures with suitable properties, such as high bending rigidity in two perpendicular directions as well as high local rigidity. Artificially added and controlled high damping properties and the absence of noisy steel plate contact connections are other desirable goals for the development of steel floor structures.

REFERENCES

1. Chien E.Y., Ritchie, J.K., Design and Construction of Composite Floor Systems. Canadian Institute of Steel Construction, Markham Ontario 1984, Canada.
2. Engebretsen Per Arne, Bjelkelag med stålprofiler av tynnplater (Floors with cold-formed steel joists). Report No.30, The Norwegian Institute for Building Research, Oslo 1980, Norway.
3. Linehan P.W., Kudder R.J., Wiss J.F., Dynamic and Human Responce Behavior of Cold-Formed Steel-joist Residential Floor Systems. Fourth International Speciality Conference on Cold-Formed Steel Structures; "Recent Research and Developments in Cold-Formed Steel Structures vol II", Univ. of Missouri-Rolla, Saint Louis 1978, USA.
4. Ohlsson Sven, Floor Vibrations and Human Discomfort. Chalmers Univ. of Technology, Div. of Steel and Timber Struct., Ph.D. Thesis, Gothenburg 1982, Sweden.
5. Ohlsson Sven, Svikt, svängningar & styvhet hos bjälklag - Dimensioneringsmetoder (Springiness, Vibrations and Stiffness Properties of Floors - Design Methods) The Swedish Council for Building Research, Publication T20:1984, Stockholm 1984, Sweden.

Leere Seite
Blank page
Page vide

Versuche zur Strukturdämpfung in Decken aus kaltgeformten Blechen

Tests on Structural Damping in Cold-Formed Steel Floors

Essais sur l'amortissement des vibrations dans les planchers légers en acier

Jürgen KÖNIG

Dr. Ing.
Schwed. Inst. für Holzforschung
Stockholm, Schweden



Jürgen König, geb. 1941, studierte Bauingenieurwesen an der TU Berlin. Nach drei Jahren in Ingenieurbüros in Berlin und Stockholm war er bis 1985 an der Technischen Hochschule in Stockholm (KTH) tätig, wo er sich hauptsächlich mit der Kaltblech- und Leichtbauforschung befasste. König ist heute verantwortlich für Projekte in der Holzbauforschung.

ZUSAMMENFASSUNG

Das wichtigste Kriterium bei der Bemessung von Leichtbaudecken sind die dynamischen Eigenschaften in Hinblick auf Vibrationen und Stossbelastungen. Decken aus kaltgeformten Blechprofilen und Plattenwerkstoffen haben in der Regel eine sehr schlechte Dämpfung. Die Resultate einer Versuchsserie an Plattenstreifen zeigen, dass Methoden der Strukturdämpfung mit viskoelastischen Belägen, wie sie seit langem im Flugzeug- und Maschinenbau verwendet werden, mit Vorteil auch im Bauwesen angewandt werden können. Bei der Wahl der Methoden wurde bewusst auf baupraktische Eignung bezüglich Materialwahl und Ausführbarkeit geachtet.

SUMMARY

In the design of light-weight floors the dynamic characteristics of the floor with respect to human response to vibrations are the most important criteria. The damping in cold-formed steel floors is normally very low. Different methods of structural damping using the concept of constrained viscoelastic layer damping, which have been applied for many years in the fields of airplane and machine structures, may be practical also for buildings. When selecting applications it was important to consider good practice and building materials which are commonly used today.

RÉSUMÉ

Dans le dimensionnement des planchers légers, les caractéristiques dynamiques du plancher en regard de la perception humaine des vibrations sont les critères les plus importants. L'amortissement dans les planchers en acier formé à froid est normalement très faible. Différentes méthodes d'amortissement structural, employant le principe d'une couche viscoélastique, et qui ont été utilisées pendant de nombreuses années dans le domaine de la construction aéronautique et mécanique, peuvent être également applicables au bâtiment. Lors du choix de la méthode, il est important de prendre en considération les règles professionnelles reconnues ainsi que les matériaux de construction existants sur le marché.



1. EINLEITUNG

Leichtbaudecken, und damit sind im Trockenbau errichtete Decken wie traditionelle Holzbalkendecken, als auch neuartige Decken aus Kaltblechprofilen und plattenartigen Werkstoffen gemeint, haben die Eigenschaft gemeinsam, dass ihre Tragfähigkeit gross und ihre Biegesteifigkeit gering ist. Das führte dazu, dass in der Regel die Biegesteifigkeit das wichtigste Bemessungskriterium ist. Die Biegesteifigkeit ist bis heute ein stellvertretendes Kriterium, stellvertretend, weil eigentlich die dynamischen Eigenschaften der Decken Gegenstand der Bemessung sind. Beim Nachweis wird untersucht, ob die absolute Durchbiegung unter einer Punktlast einen zulässigen Wert nicht überschreitet, siehe z.B. die schwedische Baunorm [1]. Die zulässige Durchbiegung ist von den gewählten Baustoffen und vom Deckenaufbau abhängig [2].

Die umfangreichen Untersuchungen von Ohlsson [3] resultierten in einem Vorschlag zur Bemessung von Leichtbaudecken [4]. Als Bemessungsgrössen dienen a) die Antwort der Decke auf eine Impulslast, b) die niedrigste Eigenfrequenz, sowie c) die relative Dämpfung. Bei Decken mit ausgeprägter einachsiger Tragwirkung hat die Vergrösserung der Biegesteifigkeit normal zur Haupttragrichtung einen sehr günstigen Einfluss auf die dynamischen Eigenschaften. Dies kann jedoch aus konstruktiven Gründen schwierig sein. Eine andere Möglichkeit ist, die Dämpfung der Decke mittels konstruktiver Massnahmen zu verbessern. Dies dürfte insbesondere bei Decken mit tragenden Elementen aus Kaltblech eine erfolgreiche Methode sein, da diese Decken eine wesentlich geringere Dämpfung als Holzbalkendecken aufweisen. Methoden der Strukturdämpfung, wie sie z.B. im Flugzeug- und Maschinenbau seit langem gebräuchlich sind, haben bislang im Bauwesen mit wenigen Ausnahmen keinen Eingang gefunden. Dies hängt mit der Schwierigkeit zusammen, wirtschaftliche und baupraktische Lösungen zu finden. Bei der Durchführung dieser Forschungsarbeit wurde bewusst versucht, baupraktisch leicht zu benutzende Methoden der Strukturdämpfung zu untersuchen. Eine ausführliche Beschreibung befindet sich in [5].

2. DÄMPFUNGSMECHANISMEN

Mit Dämpfung wird in diesem Zusammenhang die Umwandlung der mechanischen Energie einer schwingenden Konstruktion in Wärme bezeichnet (Dissipation). Diese Art der Dämpfung ist besonders gross in viskoelastischem Material. Bei den verschiedenen Methoden der Strukturdämpfung wird daher die Grundkonstruktion derartig mit viskoelastischen Belägen versehen, so dass in ihnen möglichst grosse Schubspannungen hervorgerufen werden, die die Dissipation ermöglichen, siehe z.B. [6], [7], [8].

Der einfachste Fall ist der "verdübelt Balken" mit einer viskoelastischen Leimfuge, siehe Bild 1 a). Der Gewinn an Dämpfung wird allerdings mit einem Verlust an Steifigkeit erkaufte. Eine Variante ist die Anbringung der viskoelastischen Schicht zwischen der Grundkonstruktion und einer Deck- oder Sperrschicht, die nur die Aufgabe hat, in der viskoelastischen Schicht Schubspannungen hervorzurufen (Bild 1 b). Bei Decken können Plattenwerkstoffe wie Sperrholz, Spanplatten oder Gipskarton diese Aufgabe übernehmen. Diese Methode ist für nicht vorgefertigte Deckenelemente weniger geeignet, da sehr lange Bauplatten hantiert werden müssen.

Die Methode des Dämpfungsbelages mit unterbrochener Sperrschicht dagegen, erlaubt es, Bauplatten mit kleinen, heute gebräuchlichen Abmessungen und hantierbaren Gewichten zu benutzen. Diese Theorie wurde von Plunkett & Lee [9] entwickelt und erlaubt ein- und mehrlagige Ausführungen, siehe Bild 2 und 3. Die Formeln zur Berechnung der Dämpfung, die für rechteckige Balkenquerschnitte hergeleitet wurden, können für den Fall des einlagigen Dämpfungsbelages leicht für Balken aus Kaltblechprofilen angepasst werden, siehe Bild 4.



Bild 1 a) "Verdübelter Balken" mit viskoelastischer Schicht
 b) Dämpfungsbelag mit Sperrschicht



Bild 2 Ein- und mehrlagiger Dämpfungsbelag mit unterbrochener Sperrschicht

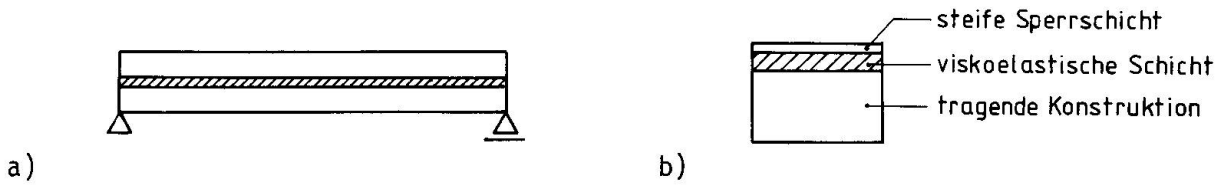

Bild 3 Balken mit Dämpfungsbelag mit unterbrochener Sperrschicht



Bild 4 Blechprofil als Balkenquerschnitt mit Dämpfungsbelag und Sperrschicht

Der Schubspannungszustand im Dämpfungsbelag ist von der charakteristischen Länge

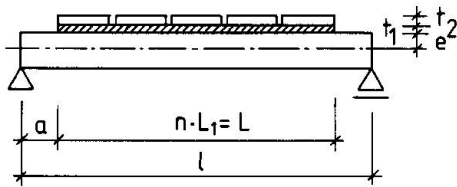
$$B_0^* = \left[\frac{E_2 t_1 t_2 b_2}{G_1^* b_1} \right]^{1/2}$$

abhängig, d.h. nur von den Steifigkeitsverhältnissen. Die Längenmasse werden in Bild 4 erläutert. E und G sind der Elastizitäts- bzw. Schubmodul. Für den Schubmodul des viskoelastischen Materials wird die übliche komplexe Schreibweise benutzt (die charakteristische Länge ist damit ebenfalls komplex)

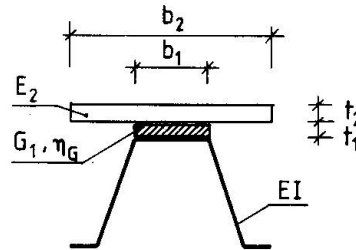
$$G_1^* = G' + i G''$$

wobei G' als Speichermodul and G'' als Verlustmodul bezeichnet wird. Der Verlustfaktor des viskoelastischen Materials ist durch

$$\eta = E''/E'$$

und der Verlustwinkel durch

$$\theta = \tan^{-1} \eta$$

gegeben, [6], [7], [8].



Der wirksame Verlustfaktor des Belages für ein Element der Länge L_1 (Bild 3) mit konstanter Dehnung der Sperrschicht beträgt

$$\eta_1 = \frac{4 \pi}{w} \left[\frac{\sinh A \sin \theta/2 - \sin B \cos \theta/2}{\cosh A + \cos B} \right]$$

wobei

$$w = L_1/B_0$$

$$A = w \cos \theta/2$$

$$B = w \sin \theta/2$$

Das Maximum für μ_1 ergibt sich für $L_1 \approx 3,2 B_0$. Für einen über seine gesamte Länge mit einem Dämpfungsbelag versehenen Balken ergibt sich der von der wirklichen Spannungsverteilung abhängige wirkliche Verlustfaktor zu

$$\eta_L = \frac{E_2 e^2 b_2 t_2}{2\pi EI}$$

woraus das logarithmische Dekrement

$$\Delta = \eta_L \pi$$

und die relative Dämpfung

$$\zeta = \frac{\eta_L}{2}$$

berechnet werden können.

3. VERSUCHE

3.1 Allgemeines

Die Versuche wurden an einer Deckenkonstruktion ausgeführt, wie sie in Schweden heute schon gelegentlich angewendet wird. Das tragende Kaltblechprofil ist ein Trapezblech, welches auf der Oberseite mit Bauplatten, heute meist Spanplatten, versehen wird. Die Unterdecke besteht meist aus Gipskartonplatten die zwecks besserer Schalldämmung mittels federnder Kaltblechprofile mit dem Trapezblech verbunden sind, siehe Bild 5. Zur Verbesserung des Trittschallmasses kann die Decke noch mit einem schwimmenden Fussboden aus beispielsweise Spanplatten und einer federnden Zwischenlage versehen werden.



Bild 5 Schematischer Aufbau einer Leichtbaudecke

Die Aufgabe der Bauplatten auf der Oberseite des Trapezbleches ist in statischer Hinsicht die Lastverteilung von Punktlasten in Querrichtung. Wenn man auf ihre mittragende Wirkung in Haupttragrichtung infolge des teilweisen Verbundes verzichtet, können Bauplatten geringer Breite zur Anwendung kommen. Bei den Versuchen wurden Gipskartonplatten mit grosser Dichte (Gyproc GG) benutzt, welche den Vorteil haben wegen ihrer geringen Abmessungen 600x2400x12,5 mm leicht handliert und eingebaut werden zu können.

Um die Wirkung verschiedener Ausführungen zur Strukturdämpfung vergleichen zu können, wurden die Messungen an Plattenstreifen durchgeführt, und zwar hauptsächlich an Plattenstreifen in der Haupttragrichtung der Decke, da bei Biegeschwingungen in der schwachen Richtung nur ein sehr kleiner Anteil der gesamten mechanischen Energie in Wärme umgewandelt werden kann.

Durch Versuche an Plattenstreifen können nur die Eigenfrequenzen und die Modaldämpfung der Streifen bestimmt werden. Die Eigenfrequenzen der ganzen Platte können mit Kenntnis der Biegesteifigkeiten in den beiden Richtungen berechnet werden. Auch die Antwort der Platte auf eine Impulslast kann nach [4] berechnet werden.

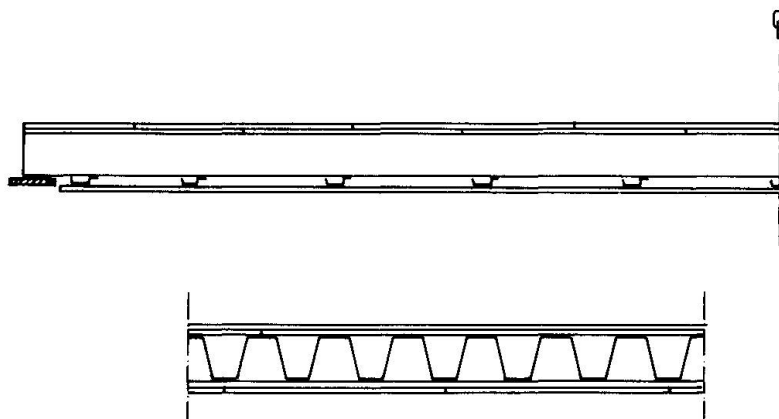
3.2 Versuchskörper

Als tragendes Kaltblechprofil wurde das Trapezblech TP 120/1,0 von DOBEL benutzt. Die Gipskartonplatten auf der Oberseite waren vom TYP GG (Gyproc) mit dem Gewicht 14 kg/m², die auf der Unterseite vom TYP GN mit dem Gewicht 9 kg/m². Es wurden handelsübliche Schnellbauschrauben benutzt.

Folgende viskoelastische Materialien wurden benutzt:

1. Dempson A5 (Icopal AB, Malmö) mit $\eta = 0,45$ und $G = 42 \text{ N/mm}^2$
2. Terostat 81 (Teroson, BRD) mit $\eta = 0,67$ und $G = 0,2 \text{ N/mm}^2$

Da keine Materialdaten für niedrige Frequenzen vorlagen, mussten diese erst versuchsmässig bestimmt werden [5]. Eine Auswahl der Prüfkörper ist in Tabelle 1 beschrieben. Alle Prüfkörper sind 600 mm breit und an ihren Enden mit der Stützweite 4,0 m einfach gelagert.

3.3 Versuchsdurchführung und Ergebnisse

Die Versuchskörper wurden in der Mitte mit einem Gummihammer zum Schwingen gebracht. Nach einigen Anfangsstörungen war die niedrigste Biegeeigenschwingung vorherrschend. Das Signal wurde mit Hilfe eines Beschleunigungsaufnehmers (Brüel & Kjaer, Typ 4370), eines Ladungsverstärkers (Brüel & Kjaer, Typ 2635) sowie eines Speicheroszilloskops (Nicolet, Typ 2050-3) während des Zeitraumes von 4 Sekunden registriert. Das logarithmische Dekrement wurde mit Hilfe der Amplitudenwerte a und der Zahl der Perioden n berechnet zu

$$\Delta = \frac{1}{n} \ln \frac{a_i}{a_{i+n}}$$

woraus die relative Dämpfung berechnet wird zu

$$\zeta \approx \Delta/2\pi$$

Die in Tabelle 2 angegebenen Werte sind Mittelwerte der ersten 10 bis 15 Perioden nach Abklingen der Anfangsstörungen. Die Dämpfung wurde langsam kleiner und betrug nach ungefähr 35 Perioden meist nur 70 bis 80 % der Tabellenwerte. Die Werte enthalten somit eine Unsicherheit betreffend ihrer absoluten Werte. Für den Vergleich der Dämpfung verschiedener Prüfkörper hat dies jedoch geringe Bedeutung.

Ausser der relativen Dämpfung wurde auch die statische Biegesteifigkeit mittels einer Linienlast in der Mitte der Spannweite bestimmt. In der Tabelle 2 ist



auch die niedrigste Eigenfrequenz angegeben sowie die, soweit es möglich war, theoretischen Werte für die relative Dämpfung.

Tabelle 1 Probenausführung der Plattenstreifen in Haupttragrichtung

| | | |
|------|--|--|
| S 4 | | <p>1 Trapezblech TP 120/1,0 4 Gipskarton GG in Quermontage nach Bild 6 a) 5 Schrauben Typ GG 11 Versteifungsprofile, mit Zwingen befestigt</p> |
| S 5 | | <p>1 Trapezblech TP 120/1,0 4 Gipskarton GG in Quermontage 5 Schrauben Typ GG 7 Blechprofil Typ IR, $c = 400 \text{ mm}$ 8 Gipskarton GN, Längsmontage 9 Blechschauben 10 Schnellbauschrauben</p> |
| S 7 | | <p>wie S 5, jedoch mit 6 Terostat 81, $t_1 = 2 \text{ mm}$</p> |
| S 13 | | <p>1 Trapezblech TP 120/1,0 4 Gipskarton GG in Quermontage nach Bild 6 b) 6 Dempison A5, $t_1 = 5 \text{ mm}$ 5, 7, 8, 9, 10 wie S 5</p> |
| S 16 | | <p>1 Trapezblech TP 120/1,0 4 Gipskarton GG in Längsmontage nach Bild 6 c) 5 Schrauben Typ GG, $c = 200 \text{ mm}$ 6 Terostat 81, $t_1 = 2 \text{ mm}$ 9 Blechschauben 11 Versteifungsprofile</p> |
| S 18 | | <p>1 Trapezblech TP 120/1,0 4 Gipskarton GG, Quermontage nach Bild 6 a) 5 Schrauben Typ GG 6 Dempison A5, $t_1 = 5 \text{ mm}$ 9 Blechschauben 11 Versteifungsprofile</p> |

Forts.

Tabelle 1 (Fortsetzung)

| | | |
|------|--|--|
| S 20 | | Bezeichnungen wie S 18 4 Gipskarton GG, Quermontage nach Bild 6 b) 10 Schnellbauschrauben |
| S 21 | | Bezeichnungen wie S 18 4 Gipskarton GG, Quermontage nach Bild 6 d) 12 Leimfuge, jedoch nicht in den kurzen Überlappungen |

Tabelle 2 Versuchsergebnisse

| Probe | $EI_{\text{stat}} \cdot 10^{-11}$ N/mm ² /m | f Hz | ζ % | ζ_{theor} % |
|-------|---|---------|--------------|-----------------------------|
| S 4 | 6,76 | 14,6 | 0,16 | |
| S 5 | 7,98 | 12,8 | 0,18 | |
| S 7 | 7,24 | 12,2 | 0,50 | 0,11 |
| S 13 | 8,67 | 12,3 | 1,63 | |
| S 16 | - | 15,4 | 0,9 | 1,23 |
| S 18 | 7,80 | 14,6 | 1,4 | 1,21 |
| S 20 | 8,47 | 13,2 | 2,4 | |
| S 21 | 7,29 | 12,9 | 2,2 | 2,36 |

Die Versuchsergebnisse zeigen, dass die Dämpfung durch viskoelastische Beläge erheblich verbessert werden kann. Die Methode der unterbrochenen Sperrschicht erfordert für die baupraktische Anwendung Beläge mit grossem Schubmodul.

Wenn der Schubmodul sehr klein ist wird die erforderliche Länge der Sperrschicht sehr gross. Eine Parameterstudie zeigt den Einfluss der Sperrschichtlänge L_1 auf die relative Dämpfung (Bild 7). Die berechneten Werte für die Proben S 18 und S 21 sind gekennzeichnet. Im Diagramm sind auch, mit unterbrochenen Kurven, berechnete Werte für die einlagige Ausführung mit 12,5 und 19 mm dicken Spanplatten dargestellt. Der geringere Elastizitätsmodul müsste in diesem Fall durch grössere Plattendicken ausgeglichen werden.



Bild 6 Anordnung des Gipskartonplatten auf der Oberseite



Bild 7 Der Einfluss der Sperrschichtlänge auf die relative Dämpfung

4. SCHLUSSWORT

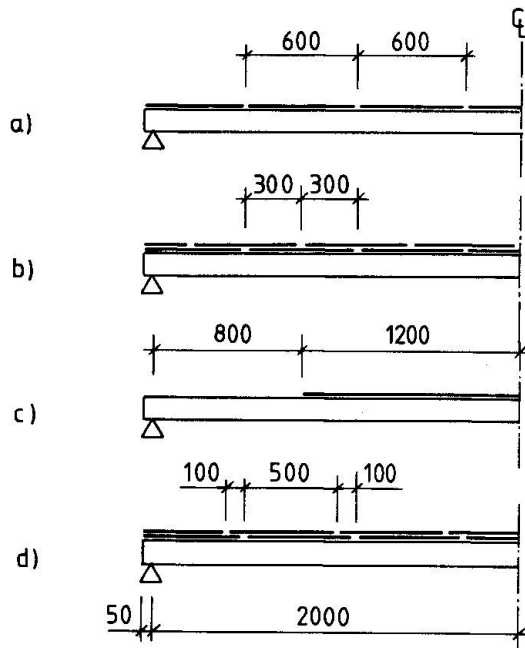
Das vorliegende Forschungsvorhaben wurde an der Technischen Hochschule in Stockholm, Abteilung für Stahlbau durchgeführt und vom Schwedischen Rat für Bauforschung (BFR) unterstützt. Eine Fortsetzung der Untersuchungen ist vorgesehen, bei der vor allen Dingen auch ganze Decken studiert werden sollen.

5. SCHRIFTTUM

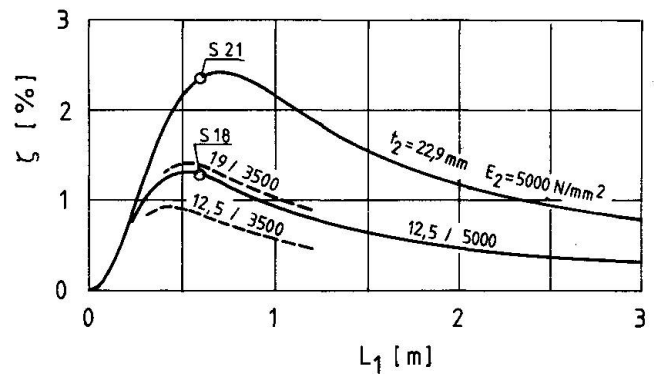
1. SBN 1980, Svensk Byggnorm. Statens planverk, Stockholm.
2. ENGBRETSSEN P.A., Bjelkelag med stålprofiler av tynnplater. Norges Byggeforskningsinstitut, arbeidsrapport 30, Oslo 1980.
3. OHLSSON S., Floor vibrations and human discomfort. Chalmers Tekniska Högskola, Göteborg, 1982.
4. OHLSSON S., Svikt, svängningar och styvhet hos bjälklag. Byggeforskningsrådet T20:1984, Stockholm.
5. KÖNIG J., Strukturdämpning i tunnplåtsbjälklag. Kungl. Tekniska Högskolan, Avd. för Stålbyggnad, Stockholm. Erscheinung geplant 1986.
6. CREMER L. & HECKL M., Körperschall. Berlin, 1967. Kap. III.
7. HARRIS C.M. & CREDE C.E., Shock and vibration handbook, Second ed. New York 1971. Chapter 37.
8. LAZAN B.J., 1966, Damping properties of materials, members and composites. Appl. Mech. Surveys, Washington, 1966.
9. PLUNKETT R. & LEE C.T., Length optimization for constrained viscoelastic damping. Journal of the Acoustical Society of America, 48(1), 1970.

New Concept for Economic and Fire-Resistant Profiled Steel Sheet Floors

Nouvelle conception de planchers mixtes économiques résistant au feu

Neues Konzept für wirtschaftliche und feuersichere
Stahltrapezprofildecken

Herbert SCHMIDT

Prof. Dr.
University of Essen
Essen, FR Germany



H. Schmidt, born 1936, Dipl.-Ing. 1962 and Dr.-Ing. 1970 from TU Braunschweig, 3 years bridges project engineer, 8 years research engineer, and 4 years head of department for constructions in Otto-Graf-Institut, Stuttgart, since 1981 chair of constructional steelwork in Essen.

Rolf LEHMANN

Dipl.-Ing.
Otto-Graf-Institut
Stuttgart, FR Germany

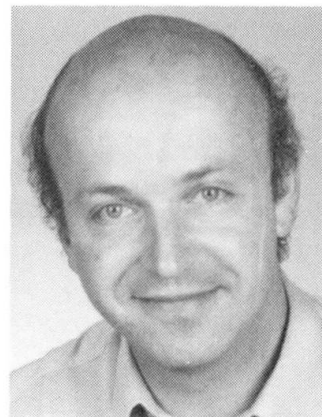

R. Lehmann, born 1943, Dipl.-Ing. 1971 from University of Stuttgart, 3 years project engineer, 7 years research engineer, since 1981 head of section for special constructions in Otto-Graf-Institut, Stuttgart.

SUMMARY

Floor systems consisting of a profiled steel sheet and concrete with additional reinforcement bars may be economically designed as an additively carrying «sheet-supported reinforced concrete slab». From a recent fire test series this design concept also turned out to be economic for fire resistance without additional protection. A modified fire resistance design procedure is proposed. The concept has been applied in a «demo-building» in Stuttgart.

RÉSUMÉ

Un plancher mixte béton-tôle d'acier profilée comportant une armature supplémentaire peut être conçu comme «une dalle nervurée en béton armé supportée par une tôle d'acier profilée» avec une capacité portante plus élevée. A partir de récents essais au feu, cette conception s'est révélée également économique vis-à-vis de la résistance au feu sans protection supplémentaire. Une méthode modifiée de calcul de la résistance au feu est proposée. Cette conception a été mise en pratique dans un bâtiment-prototype à Stuttgart.

ZUSAMMENFASSUNG

Decken aus einem Stahltrapezprofil und profilfüllendem Aufbeton mit Zusatzbewehrung können wirtschaftlich als additiv tragende «trapezprofilunterstützte Stahlbetonrippenplatte» bemessen werden. Dieses Bemessungskonzept erwies sich aufgrund einer neuen Brandversuchsserie auch für den Feuerwiderstand ohne zusätzliche Brandschutzmassnahmen als wirtschaftlich. Ein modifiziertes Brandschutz-Bemessungsverfahren wird vorgeschlagen. Das Konzept wurde beispielhaft in einem «Demo-Geschossbau» in Stuttgart angewendet.



1. INTRODUCTION

It is well known that the fire resistance of an unprotected profiled steel sheet floor can be increased by filling it up with concrete of at least 50 mm thickness above the upper sheet flange. This is due to the heat-absorbing capacity of the concrete. The fire resistance time of such floors amounts to

- at least 20 min for any sheet cross section /1/,
- more than 30 min if using a special sheet cross section /2/,
- more than 30 min for any sheet cross section if providing appropriate interlocking between sheet and concrete to make the system a composite slab /3/.

Further increases of fire resistance can - aside from using insulating coatings or suspended ceilings - only be achieved by adding reinforcement bars within the concrete ribs: The resulting type of cross section (fig. 1), used as a simply supported floor system, has recently been investigated in a series of fire tests /2/.

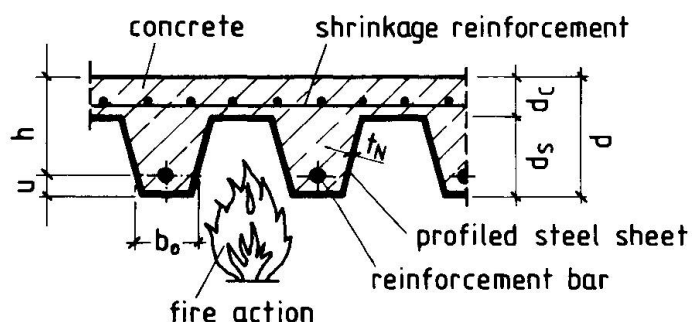

Fig. 1
Unprotected profiled steel sheet floor with fire action from below

2. STANDARD FIRE TESTS

2.1 Test Programm

The test specimens had 0,67 m width (containing two ribs) and 4,00 m span. Their cross section was built up as follows (fig. 1): $d = 200$ mm, $d_c = 60$ mm, $d_s = 140$ mm, hot rolled reinforcement bars with 420 N/mm² nominal yield stress. The profiled steel sheet had been specifically folded from hot galvanized 1 mm sheet material with 280 N/mm² nominal yield stress. Secondary corrugations of 10 mm depth along the web and upper flange center lines were to stiffen the profiled sheet and to provide a certain amount of clamping between sheet and concrete ribs. The shape was virtually identical with the one used for a demo-building in Stuttgart (fig. 8).

Table 1 gives the basic data of 14 fire tests, including one comparison test without sheet. The following parameters were varied:

- concrete covers u and b_o ;
- diameter of reinforcement bars (column RB);
- type of reinforcement against shrinkage (column RS): 1₃ = net with $0,94$ cm²/m, 2 = net with $0,85/1,70$ cm²/m, 3 = steel fibers 96 kg/m³;
- shear reinforcement in the concrete ribs no/yes (column SR);
- shear connectors between sheet and concrete no/yes (column SC). They were verified by means of flat-bar steel dowels screwed to the bottom flanges of the profiled sheet at the ends of specimen II.5B and along the whole length of specimen II.6B respectively (fig. 2);
- load level q during fire test (from allowable load $q_2 = 5,3$ kN/m² of the profiled sheet alone up to allowable load $q = 22,9$ kN/m² of the fully composite slab).

| test No. | cross section of specimens | | | | | | test results | | prediction | | | |
|----------|----------------------------|----------------------|----------|----|-----|-----|------------------------|-----------------------|------------------------------|----------------------------------|------|-------|
| | u mm | b _o mm | RB mm | RS | SR | SC | q kN/m ² | t _F min | /3/ t _F min | own α ρ t _F min | | |
| I. 3B | 35 | 120 | 14 | 1 | no | no | 5,3 | 116 | (170) | 0,37 | 0,62 | 117 |
| II. 3B | 35 | 120 | 14 | 1 | no | no | 9,8 | 105 | 103 | 0,69 | 0,62 | 105 |
| I. 4B | 35 | 120 | 14 | 1 | no | no | 13,8 | 99 | 57 | 0,96 | 0,62 | 86 |
| II. 4B | 35 | 120 | 14 | 1 | no | no | 22,9 | 69 | 0 | 1,59 | 0,62 | 51 |
| III.2B | 35 | 120 | 8 | 1 | no | no | 5,3 | > 74 | 50 | 0,64 | 0,35 | 73 |
| III.3B | 35 | 120 | 10 | 1 | no | no | 10,5 | 78 | 0 | 0,97 | 0,50 | 70 |
| III.4B | 35 | 120 | 10 | 1 | no | no | 14,0 | > 50 | 0 | 1,30 | 0,50 | 52 |
| III.5B | 70 | 140 | 14 | 1 | no | no | 14,0 | > 92 | 0 | 1,11 | 0,57 | (104) |
| SF3B | 35 | 120 | 14 | 3 | no | no | 14,4 | > 84 | 56 | 1,00 | 0,62 | 83 |
| SF4B | 35 | 120 | 10 | 3 | no | no | 11,1 | > 82 | 0 | 1,05 | 0,48 | 61 |
| II. 2B | 35 | 120 | 14 | 2 | yes | no | 9,8 | 116 | 103 | 0,69 | 0,62 | 105 |
| II. 5B | 35 | 120 | 14 | 1 | no | yes | 22,9 | 64 | 0 | 1,59 | 0,62 | 51 |
| II. 6B | 35 | 120 | 14 | 1 | no | yes | 22,9 | > 69 | 0 | 1,59 | 0,62 | 51 |
| II. 1B * | 35 | 120 | 14 | 2 | yes | ./. | 9,8 | 93 | | ./. | | |

* Comparison test with sheet removed before fire test

Table 1 Extract from fire test programm /2/

Fig. 2

Profiled sheets of test specimens II.5B (right) and II.6B (left) before fixing of reinforcement and concrete form

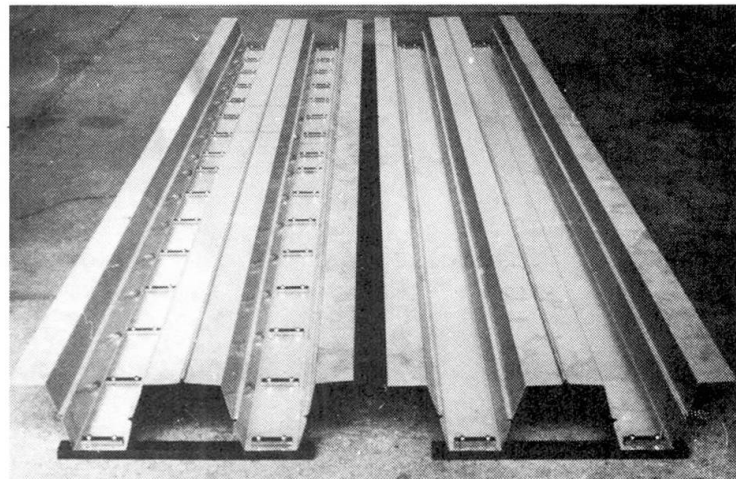

2.2 Heating Behavior

The heating behavior under standard fire exposure (fig. 3) is characterized by rapid temperature increase in the sheet, medium temperature increase in the reinforcement bars and slow temperature increase at the unexposed side of the concrete. Considering only the load bearing capacity criterion for fire resistance, the concrete temperatures may be neglected. The sheet becomes after about 60 min in all its parts so hot ($\geq 800^{\circ}\text{C}$) that, because of the yield limit having decreased to less than 10 %, it cannot bear furthermore a significant part of the load. Nevertheless it remains positively effective in two ways: firstly by preventing the concrete from chipping off and secondly by screening it thermally.

The thermal screening effect of the sheet causes the reinforcement bar to heat up by about 15 min slower than it would have done without sheet. After about 80 to 100 min it reaches the critical temperature $\text{crit } T$ of about 500 to 600°C (fig. 3); a specimen with allowable stress in its reinforcement bars would be expected to fail around this time. In fact, if one looks at the deflection-time-curve of test specimen II.3B (fig. 4) being loaded by the approximate allowable load $q = 9,8 \text{ kN/m}^2$ of the present reinforced concrete slab, the observed rapid deflection increase beyond 100 min fits well to the measured temperatures. Moreover, the deflection-time-curve of test II.1B (without sheet)



confirms the thermal screening effect of the sheet of about $\Delta t = 15$ min (fig. 4).

Fig. 3
Typical temperature-time-curves under standard fire exposure (test I.3B)

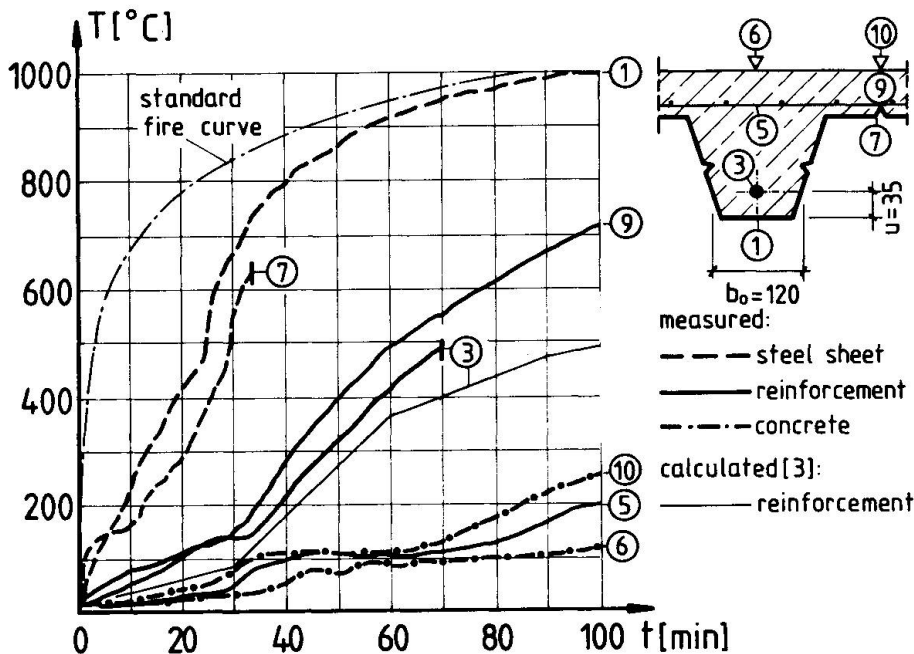

2.3 Fire Resistance

Table 1 contains the experimental fire resistance times t_F (deflection speed criterion of DIN 4102/2). They show, additionally illustrated by fig. 4, three important facts:

(a) Compare test II.1B with test I.4B: The latter yielded about the same fire resistance, in spite of being loaded higher and having no shear reinforcement in the concrete ribs. Obviously the profiled sheet adds to the "naked" reinforced concrete slab enough positive effects (thermally and mechanically) to compensate for the omitted shear reinforcement and to bear additionally nearly its own allowable load without loss of fire resistance.

(b) Compare tests II.4B, II.5B and II.6B: All of them had identical cross sections and were loaded identically by the allowable load if assuming full composite action. But only specimens II.5B and II.6B actually had shear connectors between sheet and concrete. As can be seen, test II.4B yielded about the same fire resistance.

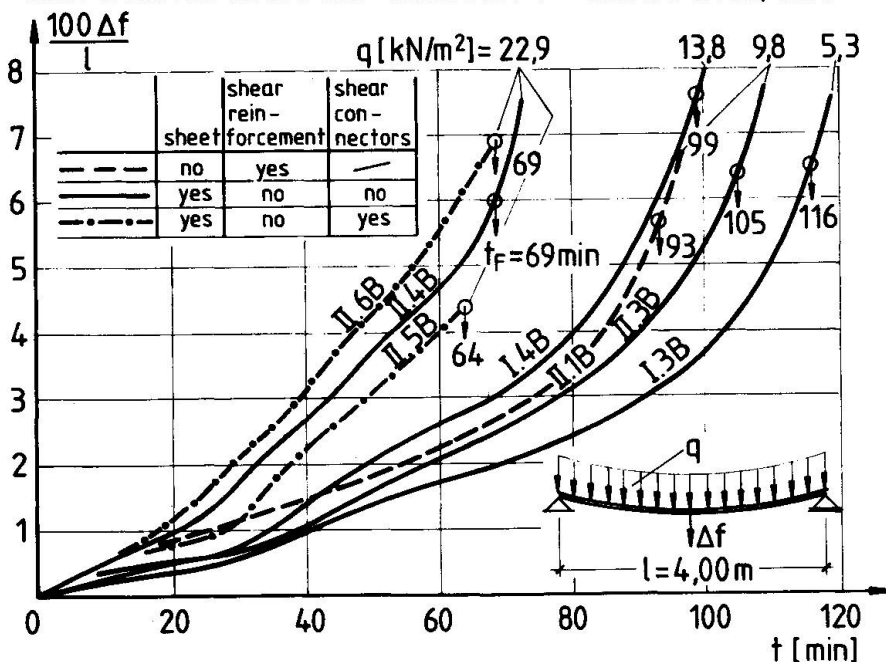

Obviously the composite action - well known to be highly beneficial for the ultimate load under ambient temperature - has no significant improving effect for the load bearing under fire conditions. Thinking of the heating behavior explained before, this result does not surprise:

Fig. 4
Deflection-time-curves under standard fire exposure

After more than 60 min fire time, there cannot be a significant difference between a "not carrying shear-connected sheet" and a "not carrying independant sheet".

(b) Compare tests I.3B, II.3B, I.4B and II.4B: All of them had identical cross sections, but were loaded differently. The load level clearly influences the achieved fire resistance.

3. DESIGN CONCEPT

3.1 General

From the foregoing brief description of selected test results (for detailed information see /2/) the following conclusions concerning an economic concept for fire-resistant unprotected profiled steel sheet floors may be drawn:

(a) Reinforcement in the concrete ribs is necessary to achieve $t_F \geq 60$ min.

(b) The floor may be designed for the working load case under ambient temperature as "sheet-supported reinforced concrete slab" (i.e. profiled sheet and reinforced concrete slab bearing additively) without giving away the chance of achieving $t_F \geq 90$ min.

(c) No shear reinforcement in the concrete ribs is necessary if adequate allowable shear stresses are not exceeded.

(d) No composite action between sheet and concrete is necessary. If nevertheless provided, it cannot be utilized for the fire load case.

3.2 Design for Construction Load Case

The profiled steel sheet has to be designed for its own and the concrete's dead load ($g_1 = 3$ to 4 kN/m²) plus a "construction live load" (e.g. $p_1 = 1,50$ kN/m²). The authors recommend to choose a sheet cross section that does not need being intermediately supported during concreting. This implies a cross section depth of at least $d_s = 120$ mm for spans of about 4 m. The advantage of such a design philosophy - besides resulting in smaller concrete dead loads because of the high ribs - is that during floor construction nothing needs to be done from below. For instance, in a multistory building higher floors could, if for any construction processing reason desirable, be concreted earlier than lower ones.

3.3 Design for Working Load Case

The sheet-supported reinforced concrete slab has to be designed for the total load $q = g + p$. Fig. 5a shows as an example the statical system of a two span floor with simply supported sheets and continuously concreted slab. The total load is split into the partial loads of the reinforced concrete slab and the steel sheet:

$$q_{RC} = \varrho q, \quad (1)$$

$$q_{SS} = (1 - \varrho)q$$

with the load sharing factor ϱ .

Fig. 5

Example for a sheet-supported reinforced concrete slab
 a) statical system
 b) limit state mechanism

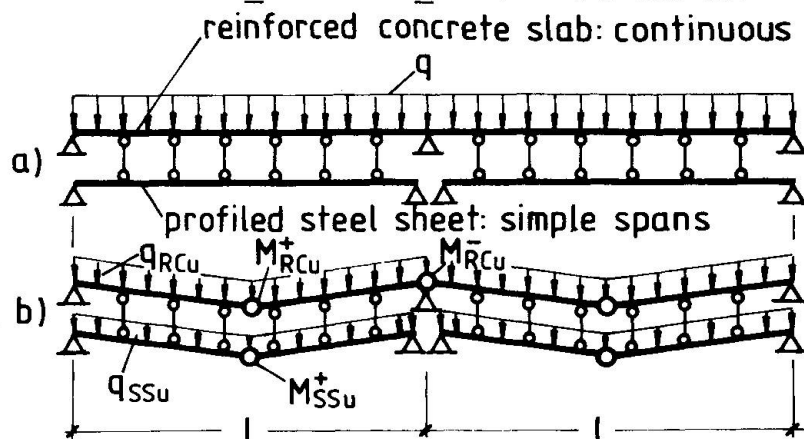



The factor φ may be calculated from elementary plastic theory (fig. 5b):

$$\varphi = \frac{q_{RCu}}{q_{RCu} + q_{SSu}} = \frac{M_{RCu}^+ + 0,5 M_{RCu}^-}{M_{RCu}^+ + 0,5 M_{RCu}^- + M_{SSu}} \quad (2a)$$

or from the relevant allowable loads:

$$\varphi = \frac{\text{all } q_{RC}}{\text{all } q_{RC} + \text{all } q_{SS}} \quad (2b)$$

The slab and the sheet have to be designed for their partial loads respectively. Particular attention should be paid to the critical shear stress in the comb-like concrete cross section

$$\tau_o = Q_{RC}/(b_o z) \leq \text{all } \tau_o \quad (3)$$

According to DIN 1045, the allowable shear stress all τ_o may be taken as 0,5 N/mm² for concrete with ≈ 25 N/mm² nominal strength.

3.4 Design for Fire Load Case

Since the sheet - as stated before - does not bear a significant part of the load after medium fire times, its load bearing capacity may be neglected for the fire load case. This assumption leads to the design model of a "thermally screened RC-slab" which has to carry alone the total load, but of which the concrete and reinforcement are heated up slower because of the presence of the hot sheet. This design model has been developed in /3/; simple formulae are given for the temperature-time and strength-temperature relations of the concrete (negative moments) and the reinforcement in the ribs (positive moments) respectively. With increasing fire time, the decreasing limit load (using elementary plastic theory) has to be calculated; once the decreasing limit load equals the present load q , the fire resistance time is assumed to be reached.

The temperature-time formulae of /3/ for the reinforcement bar in the rib have been checked against own and published temperature measurements. They give good agreement for relatively large concrete covers u and b_o , but seemingly tend to underestimate the heating speed for medium and small concrete covers, especially for longer fire times (> 80 min) and higher temperatures ($> 500^\circ\text{C}$). The comparison curve 3 in fig. 3 indicates this lack. An effort to evaluate improved temperature formulae from systematic numerical simulation of the heating behavior is currently on the way /4/.

For the 13 sheet-supported test specimens in table 1 the predicted t_F -values, using the design procedure of /3/ with actual material properties, have been calculated (table 1). The agreement is excellent if the load approximately corresponds to all q_{RC} (II.3B, II.2B). This is evident, since the procedure has been calibrated to this case. For lower loads the prediction - received by linear extrapolation of the design formulae in /3/ beyond 120 min - would be very unconservative (I.3B). This is probably due to the mentioned underestimate of temperatures. For higher loads the prediction, though being conservative, is unsatisfyingly poor. The reasons are: firstly the neglecting of the sheet's load bearing contribution and secondly the fact that the true bending capacity of comb-like RC-slabs is much higher than the plastic moment; every standard fire test derives unavoidingly benefit from this "hidden" safety.

In order to overcome the discrepancies, a modification of the design procedure, as illustrated in the schematic chart of fig. 6, is proposed by the authors /2/. The polygonal curves represent, for a given floor cross section

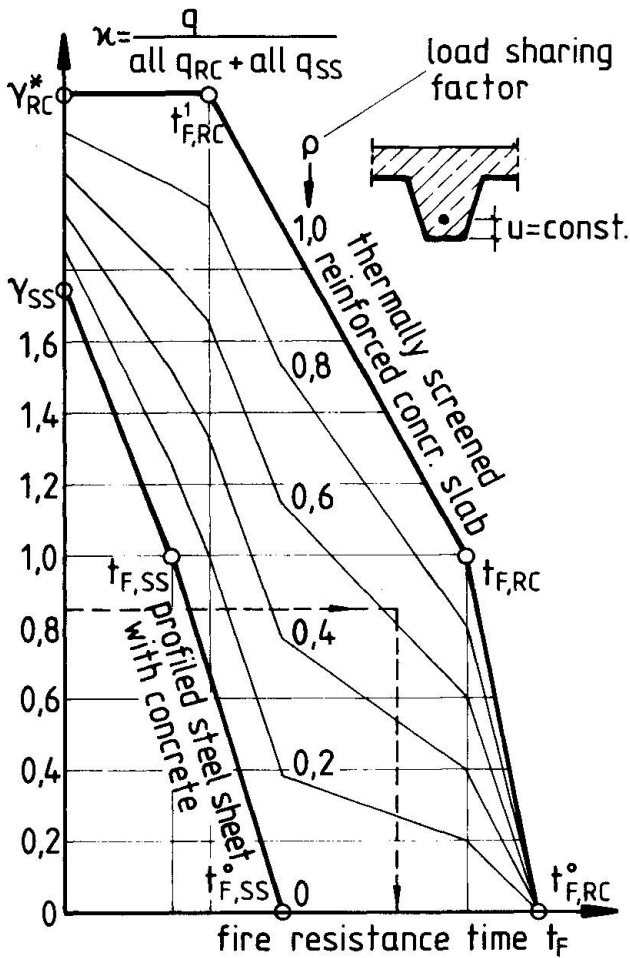

Fig. 6
Fire resistant design chart
(schematic) for a profiled
steel sheet floor

type, nondimensional load bearing capacities (related to the allowable load $all\ q_{RC} + all\ q_{SS}$) versus t_F . The curves are, according to their load sharing factor (equ. 2), linearly interpolated between the two limiting cases of the sheet-supported RC-slab:

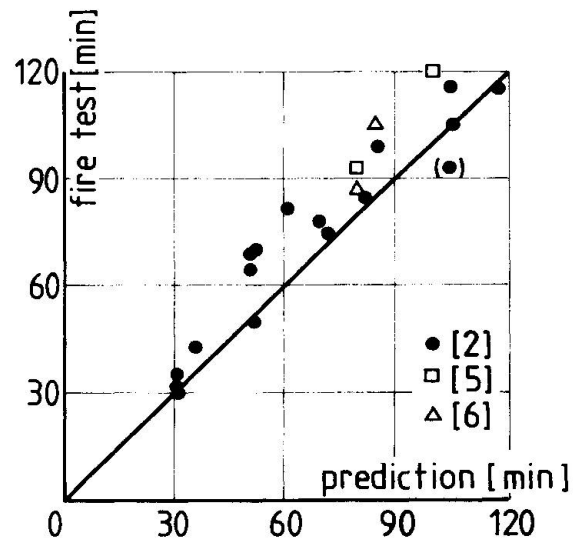

Fig. 7
Comparison of experimental and
predicted fire resistance times

(a) Thermally screened RC-slab (upper curve):

- $t_{F,RC}^1$ and $t_{F,RC}^0$ = time until $T = 250^\circ\text{C}$ and $T = \text{crit } T$ in the reinforcement, calculated from the formulae in /3/.
- $t_{F,RC}^0$ = time until $T = 800^\circ\text{C}$ in the reinforcement; may conservatively be estimated as $t_{F,RC}^0 = t_{F,RC}^1 + 20\text{K}$.
- γ_{RC}^* = true safety factor of the RC-slab under ambient temperature; may be assumed as $\gamma_{RC}^* = 2,50$.

(b) Profiled sheet with unreinforced concrete (lower curve):

- $t_{F,SS}$ and $t_{F,SS}^0$ = time until $T = \text{crit } T$ and $T = 800^\circ\text{C}$ in the sheet; may conservatively be assumed as 30 and 60 min.
- γ_{SS} = safety factor of the sheet = 1,75.

For given values κ (relative working load) and ϱ the fire resistance time may be read from the chart. In table 1 the results of this prediction method for all 13 tests are given; the agreement with the test results is reasonable. Fig.7 illustrates the comparison graphically, including 4 tests without reinforcement from /2/ and 2 tests from /5/ and /6/ respectively.



4. PRACTICAL APPLICATION

In a 4-story laboratory "demo-building" of the Otto-Graf-Institut in Stuttgart, in which many prototypes of newly developed fire-resistant steel-concrete components (floors, beams, columns, connections) are demonstratively used, the present design concept has been applied to one of the floors (fig.8). It is a 3-span floor with $p = 5\text{ kN/m}^2$ live load and F 90 fire resistance. The slab has been connected to the prefabricated composite HEA-300 beams by studs in order to make it the compression flange of a 500 mm deep composite floor girder with 9,20 m span.

Fig. 9 shows impressively the construction advantages of self-carrying profiled sheets.

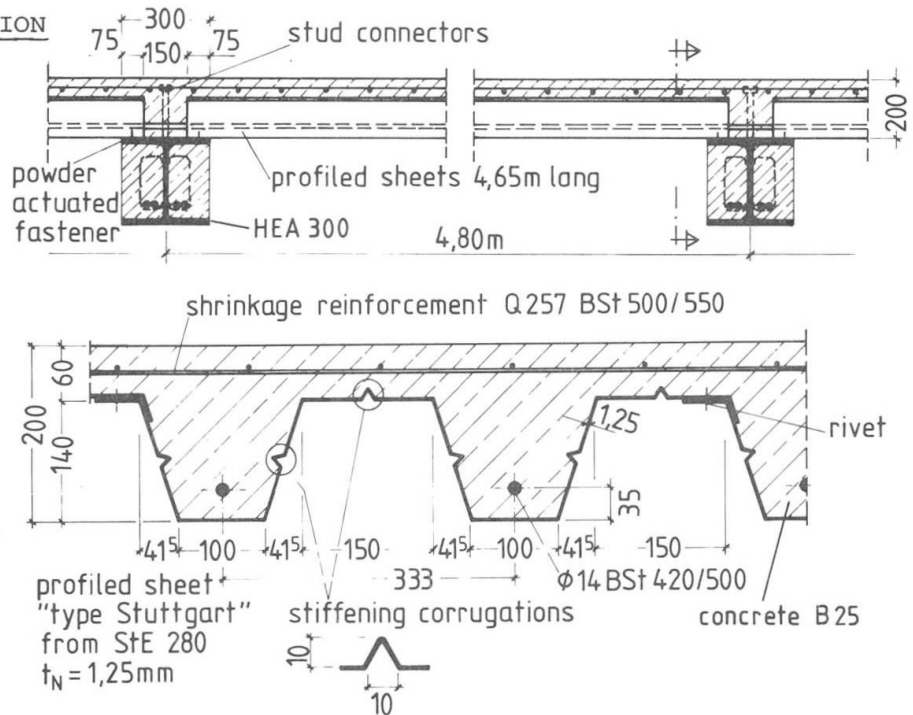

Fig. 8 Sheet-supported reinforced concrete slab in demo-building



Fig. 9 Demo-building under construction

REFERENCES

1. KORDINA K., MEYER-OTTENS C.: Beton-Brandschutz-Handbuch. Düsseldorf, Betonverlag 1980.
2. LEHMANN R., SCHMIDT H.: Final Report on Research Proj. 86/2.7 of Stud. gesellsch. Anw. technik Eisen Stahl, Düsseldorf 1985.
3. BRYL S., KRUPPA J., TWILT L.: Calculation of the fire resistance of composite slabs ... TN-ECCS-CT3, Delft 1983.
4. HÖNIG O., KLAUS J., SCHMIDT H., LEHMANN R.: Heating behavior of profiled steel sheet floors (in preparation).
5. JUNGBLUTH O., BERNER K.: Final Report on Research Proj. 42 of Stud. gesellsch. Anw. technik Eisen Stahl, Düsseldorf 1979.
6. Report on fire tests with "SIEBAU-Geschoßdecke" of Inst. f. Baustoffe, Massivbau u. Brandschutz, Braunschweig 1977 (unpubl.).

Brandsicherheit bei Dächern und Wänden aus Stahltrapezprofilen

Fire Safety for Roofs and Walls of Corrugated Sheet Steel

Sécurité contre l'incendie de toitures et façades en tôle d'acier profilée

Horst WITTE

Dr.-Ing.
INSTRUCT
Wiesbaden, BR Deutschland



Horst Witte, geb. 1928, Studium Bauingenieurwesen bis 1955, Promotion 1959. Tätigkeit im Stahlbau, in der stahlerzeugenden und stahlverarbeitenden Industrie, Leiter der Forschung in einem Konzern, einige Jahre Lehrbeauftragter, seit 1980 eigene Gesellschaft für Forschung und Entwicklung.

Wolfram KLINGSCH

Prof. Dr.
Bergische Universität
Wuppertal, BR Deutschland



Wolfram Klingsch, geb. 1944, Studium Bauingenieurwesen bis 1970, Promotion 1975, praktische Tätigkeit als beratender Ingenieur, Lehrbeauftragter, seit 1982 Inhaber des Lehrstuhls für Baustofftechnologie und Brandschutz an der Bergischen Universität Wuppertal.

ZUSAMMENFASSUNG

Dächer und Wände aus Stahltrapezprofilen können brandsicher ausgeführt werden. Die Rückwirkung von Dach und Wand auf das Brandgeschehen wird beschrieben. Die raumabschliessende Wirkung unter Brandtemperaturen hängt von der Befestigung ab.

SUMMARY

Roofs and walls of corrugated sheet steel can be made fire proof. The interaction between roofs and walls and the fire is described. The room enclosing function in the case of fire depends on the strength of the connections.

RÉSUMÉ

Les toitures et façades en tôle d'acier profilée peuvent être construites résistantes au feu. On décrit dans cette contribution la réaction de toitures et façades légères face au feu. La fonction enveloppe en cas d'incendie dépend de la résistance des assemblages.



1. EINLEITUNG

Dächer und Wände werden in der Bundesrepublik Deutschland in erster Linie als raumabschließende Bauteile für Industriebauten, Lagergebäude und Supermärkte eingesetzt. Bauaufsichtliche Anforderungen für eine Feuerwiderstandsklasse bei nichttragenden Bauteilen werden in der Regel nicht gestellt. Die Forderung nach Sicherheit gegen Flugfeuer und strahlende Wärme, d.h. gegen Brandeinwirkung von außen werden von allen marktüblichen Stahltrapezdächern erfüllt. Speziell für Dächer aus einschaligen, wärmegeprägten Stahltrapezprofilen hat die Vereinigung zur Förderung des Deutschen Brandschutzes Empfehlungen erarbeitet /1/, die sich auf Forschungsarbeiten stützen /2/.

Dächer und Wände aus Stahl bestehen aus mehreren Schalen und Schichten mit unterschiedlicher Funktion. Das profilierte Stahlblech dient als tragende Schicht, bei der Verwendung als Außenhaut auch als regendichte Wetterhaut. Zur Wärmedämmung dienen Kunststoffhartschäume, Mineralfaserdämmstoffe, Schaumglasplatten u.a., d.h. brennbare und nichtbrennbare Stoffe. Für die Dampf- und Winddichtigkeit werden Dampfsperren und Luftsperrern aus brennbaren oder nichtbrennbaren Folien, oft auf bituminösen Trägerbahnen eingesetzt. Die äußere Haut besteht bei Wänden in der Regel aus Metallprofilen, beim Dach neben der metallischen Dachdeckung auch aus Kunststoffbahnen oder Bitumendachbahnen. Während früher allein das Brandverhalten der einzelnen Baustoffe beachtet und geprüft wurde, setzt sich jetzt die Erkenntnis durch, daß das Zusammenwirken der Stoffe andere Eigenschaften zeigt als das Verhalten der Baustoffe allein /2,3/.

2. MASSNAHMEN FÜR DIE BRANDSICHERHEIT

Eine der wichtigsten Forderungen an Dächer und Wände aus Stahltrapezprofilen ist die Verhinderung der Brandfortleitung. Die beste Maßnahme gegen die Brandausbreitung innerhalb der Bauteile ist die Verwendung nichtbrennbarer Baustoffe. Wenn dazu aber eine brennbare oder schmelzende und brennend herabtropfende Dampfsperre verwendet wird, so ist der positive Effekt der nichtbrennbaren Dämmschicht wirkungslos (Bild 1 nach /4/). Eine brennbare Dampfsperre sollte entweder vermieden werden, oder es ist eine Schicht mit möglichst geringer brennbarer Mas-



Bild 1 Brandlast im Dach

Fig. 1 Fire load density in the roof

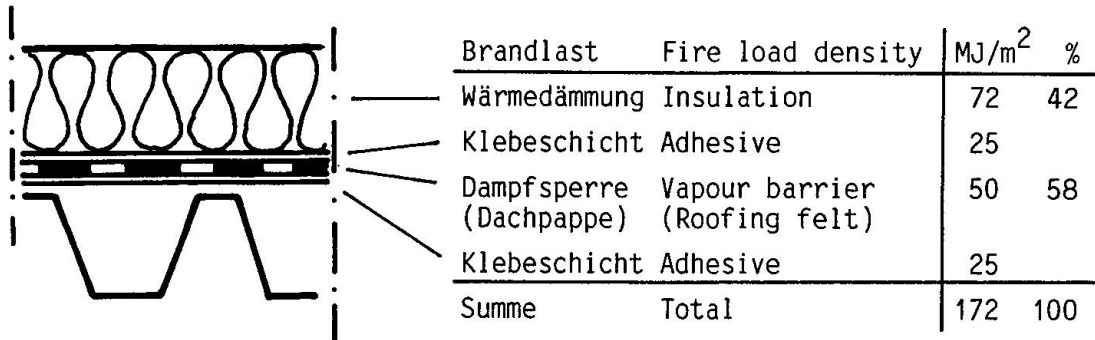

Bild 2 Abschotten der Sicken

Fig. 2 Barrier in the profiled sheet

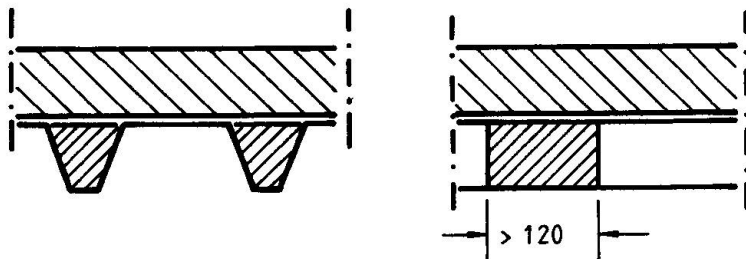

Bild 3 Sauerstoff-Zutritt in der Wandkonstruktion

Fig. 3 Oxygene-ventilation in the wall-structure

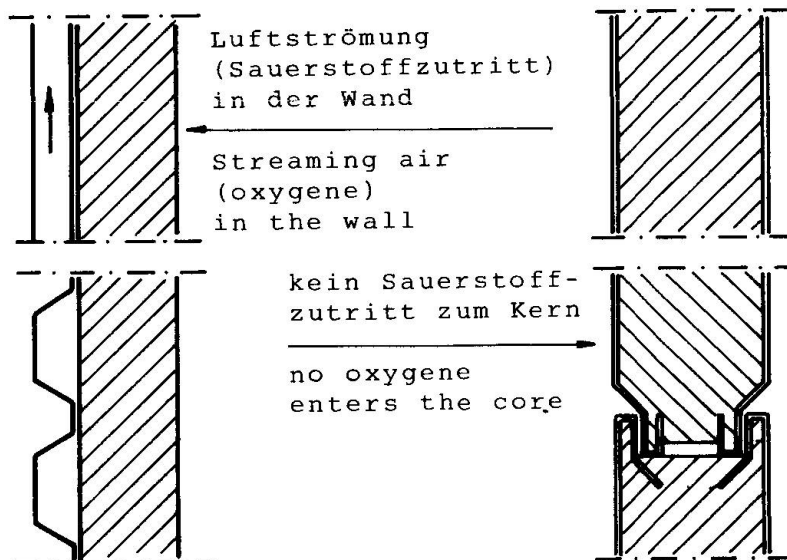

se zu verwenden. Abschottungen der Sicken mit nichtbrennbarem Material bilden Barrieren gegen die Brandweiterleitung (Bild 2). Mindestens an Brandwänden ist eine Abschottung vorzusehen. Die Brandfortleitung auf der Dachoberseite kann durch eine Bekiesung (5 cm), einen Brandschutzanstrich auf der bituminösen Dachhaut oder Anordnung einer Brandschutzbahn verhindert werden. Bei einer nichtbrennbaren Dachhaut aus Metallprofilen, d.h. beim zweischaligen Dachaufbau erübrigen sich solche Maßnahmen. Da ein Brand in starkem Maße von der Sauerstoffzufuhr abhängt, sind die Ventilationsbedingungen im Bauteil zu beachten. Bei einer Sandwichwand verhindern die Deckschichten aus Stahl den Luft- und Sauerstoffzutritt. Die Brandfortleitung ist trotz der brennbaren Kernschicht gering. Ein Polyurethanschaum, der ohne Deckschichten normalentflammbar ist (B 2 nach DIN 4102), wird zwischen Stahldeckschichten zum schwerentflammbaren Baustoff (B 3). Diese Anordnung ist in Bild 3 dargestellt.

3. INTERAKTION ZWISCHEN BRAND UND BAUTEILEN

Bei experimentellen und rechnerischen Brandschutzuntersuchungen wird in der Regel die Temperatureinwirkung auf das Bauteil untersucht. Als Maß der Temperaturbeaufschlagung dient normalerweise die Einheitstemperaturzeitkurve nach ISO 834 (DIN 4102), oder bei differenzierteren Analysen eine Temperaturkurve für einen sog. natürlichen Brand. Der Einfluß der Umfassungsbauteile auf die Brandtemperatur wurde von Schneider /5/ untersucht. Eine Weiterführung dieser Forschungsarbeit erfolgt zur Zeit durch ein vom Bundesministerium für Forschung und Technologie gefördertes Forschungsprojekt /6/. Dort wird in Brandraumsimulationsanalysen auch die Veränderung des thermischen Verhaltens der Bauteile im Brand untersucht. Bild 4 zeigt ein Beispiel : Halle 30 x 30 x 6 m, Brandlast 30 kg Holz pro m², Dach und Wand aus Stahltrapezprofilen mit einer Dämmschicht, die einer 80 mm dicken Polystyrolschicht entspricht. Der berechnete Temperaturverlauf ist in Bild 4 dargestellt und zwar in Kurve (1) bei der Annahme einer konstant wirksam bleibenden Wärmedämmung. In Kurve (2) ist berücksichtigt, daß ab 300⁰C keine Wärmedämmung mehr vorhanden ist. Bei verschwindender Wärmedämmung erfolgt demnach bei diesem Beispiel eine Temperaturentlastung in der Spitze um

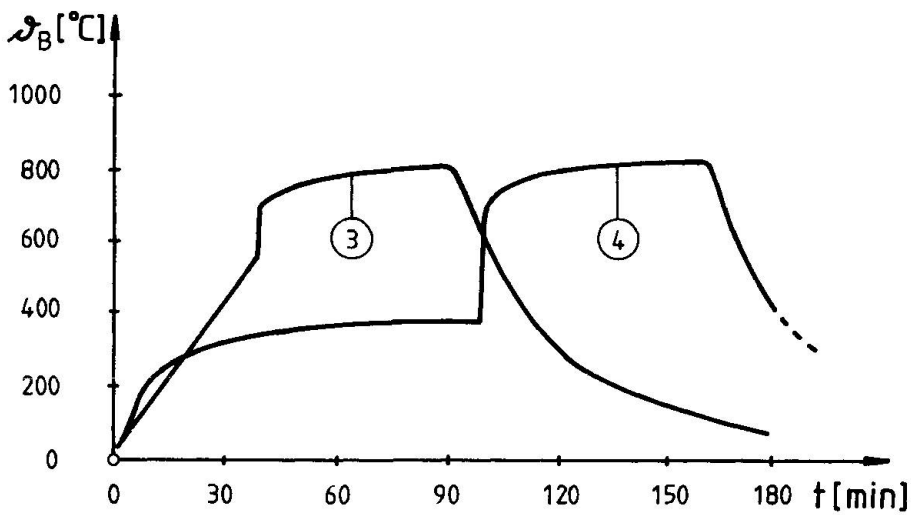
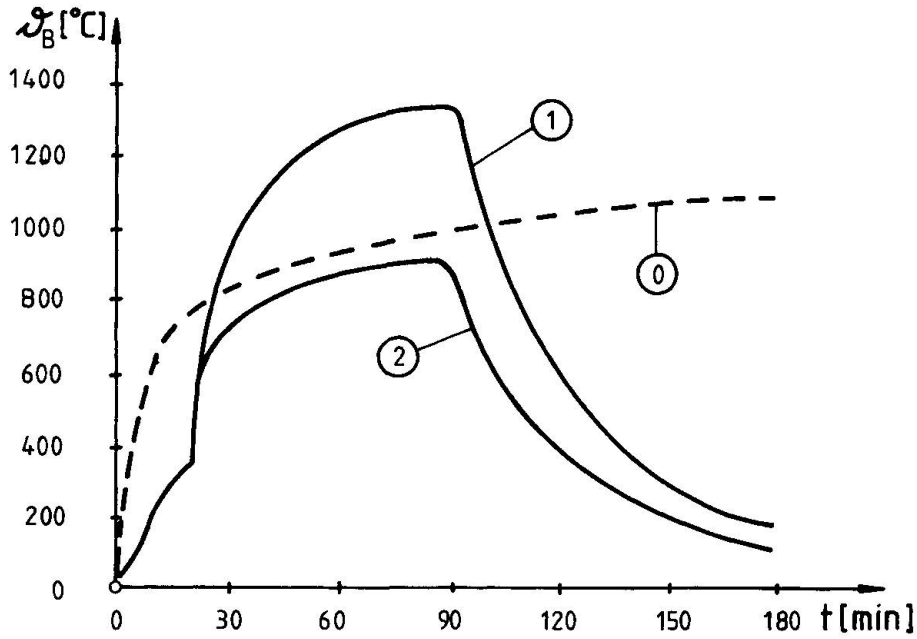

| Kurve | | curve | |
|-------|--|-------|--|
| 0 | ETK | 0 | ISO 834 |
| 1 | bei nicht brennbarer Wärmedämmung | 1 | with non combustibile insulation |
| 2 | bei verschwindender Wärmedämmung | 2 | with lost insulation |
| 3 | bei offenen Fenstern | 3 | with open windows |
| 4 | mit Fenstern, die ab 250 °C zerspringen | 4 | with windows, which are destroyed at 250 °C |

Bild 4 Temperatur-Zeit-Kurven

Fig. 4 Temperature-time-curves



ca. 450 K. Eine andere "Antwort" der Bauteile auf die Brandeinwirkung ist das Öffnen von Wand- oder Dachflächen. Fenster zerspringen, Lichtkuppeln schmelzen. Bild 4 zeigt Ergebnisse aus einer Simulationsrechnung für eine Halle 40 x 40 x 8 m mit einer Wärmedämmung, die sich im Brand zersetzt und mit Fensteröffnungen von 80 m². In Kurve (3) sind die Fenster bei Brandbeginn bereits offen, Kurve (4) zeigt den Temperaturverlauf, wenn sich die Fenster bei 250°C öffnen. Dieser Fall zeigt eine zeitliche Verschiebung der Temperaturkurve. Die Höhe der maximalen Temperatur bleibt davon unbeeinflusst.

Die Ergebnisse sind hier aus der laufenden Forschung beispielhaft dargestellt. Eine Verallgemeinerung dieser Kurven ist nicht möglich.

4. STANDFESTIGKEIT DER STAHLTRAPEZPROFILE

Wenn im Brandfall die tragende Unterkonstruktion ihre Standfestigkeit behält, so gibt es für die Stahltrapezprofile zwei Verhaltensmöglichkeiten: Sie lösen sich von ihren Endauflagern und hängen herab (Gardinen-Effekt) oder sie bleiben an ihren Enden mit dem Auflager verbunden (Matten-Effekt). Dies ist in Bild 5 gezeigt.



Bild 5 Versagensarten von Stahltrapezprofilen im Brand

Fig. 5 Failure of corrugated sheets in a roof

In beiden Fällen haben sie zwar ihre normale Gebrauchsfähigkeit verloren, im letzteren Fall behalten sie aber ihre raumabschließende Wirkung und können die Verbreitung offener Flammen nach außen verhindern. Welcher Effekt im Brandfall erwünscht ist, hängt von der jeweiligen Situation ab. Die nachfolgende Traganalyse soll dem mit dem Brandschutzentwurf befaßten Ingenieur die Möglichkeit geben, brandschutzgerecht zu konstruieren (Brandschutz nach Maß).

Nach Witte /7/ entsteht bei unverschieblichen Auflagern für das biegesteife Stahltrapezprofil die Horizontalkraft H nach Bild 6.

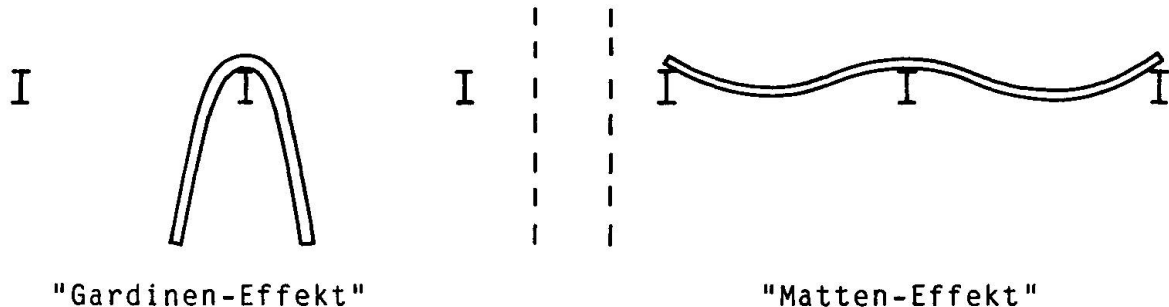
$$H = \chi_E E_0 \cdot A \left[\left(\frac{4}{\pi^5} \frac{q \cdot l^4}{\chi_E E_0 J (1 + \alpha)} \right)^2 \cdot \frac{8}{3 l^2} - \alpha \cdot \vartheta - \frac{8}{l} \right] .$$

Hierin sind

A die Querschnittsfläche des Trapezprofils,

J das Biegeträgheitsmoment des Profils,

E_0 der Elastizitätsmodul unter Normaltemperatur,

χ_E der Abminderungsfaktor für E_0 unter Brandtemperaturen,

ϑ die Brandraumtemperatur, in diesem Fall gleich der Temperatur des Stahltrapezprofils,

α der Temperatureausdehnungskoeffizient für Stahl.

Wenn der Querschnitt bei steigender Temperatur plastiziert, bleibt nach dem Verlust der Biegesteifigkeit die Seilwirkung des Trapezprofils (Matteneffekt). Dann trägt das Profil nur durch die Zugkraft H mit

$$\frac{H^3}{\chi_E \cdot E_0 \cdot A} + (1,2 \cdot 10^{-5} \cdot \vartheta + \frac{a}{l}) H^2 = \frac{q \cdot l^2}{24} ,$$

mit der Bedingung $H \leq \beta_S (\vartheta) \cdot A$.

β_S ist die temperaturabhängige Streckgrenze.



Bild 6 Tragwirkung von Trapezprofilen im Brand

Fig. 6 Load bearing system in the case of fire

Für die nachstehende Analyse werden die temperaturabhängigen Werkstoffgesetze für die Streckgrenze und den Elastizitätsmodul angewandt, die für Walzstahl St 37 ermittelt wurden. Die für Stahltrapezprofile, d.h. dünnwandige kaltverformte Bleche gültigen Gesetze bedürfen noch eines Nachweises.

Unterstellt man, daß im Katastrophenfall Brand nur noch das Eigengewicht als Belastung wirkt, so liegt der Auslastungsgrad der Tra-

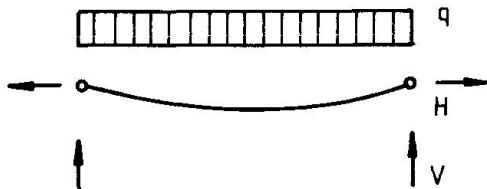

pezprofile bei $\alpha = 0,08$ bis $0,09$, d.h. die Profile haben nur noch den $0,08$ bis $0,09$ -fachen Anteil der Bemessungslast zu tragen. Eine Auswertung der o.g. Formeln für 2 Profile (Profil 40/183 und Profil 160/250) hat ergeben, daß die Versagenstemperaturen für die Profile oberhalb von 850°C liegen, wenn die Auflagerkräfte aufgenommen werden können. Wenn die Tragfähigkeit der Stahltrapezprofile bis 850°C (in bestimmten Fällen noch höher) erhalten bleiben soll, muß die Auflagerbefestigung die gleiche Tragfähigkeit besitzen. Über die Tragfähigkeit von Schrauben (z.B. Bohrschrauben) liegen noch keine gesicherten Werte vor. Eine Abschätzung ergibt, daß bei Stahlschrauben Auslastungsgrade für die Stahltrapezprofile von $0,05$ bis $0,15$ erreicht werden können. Werkstoffe mit niedrigeren Schmelzpunkten oder Dächer mit höheren Nutzlastanteilen führen zu dem vorgenannten Gardinen-Effekt.

Literatur

- /1/ VFDB, Empfehlungen für eine Begrenzung der Brandübertragung bei einschaligen, wärme gedämmten Stahltrapezprofilen, VFDB 33(1984) Heft 4, Verlag Kohlhammer, Stuttgart
- /2/ BREIN, D., SEEGER, P.G., Brandversuche an wärme gedämmten Stahltrapezprofil dächern, Forschungsstelle für Brandschutztechnik an der TU Karlsruhe, 1982
- /3/ HERTEL, H., Neue Prüfgrundsätze für schwer entflammbar und nicht brennbare Baustoffe, Bauphysik 7(1985), Ernst & Sohn, Berlin
- /4/ FEDEROLF, S., Was lehren uns die Brandfälle und die Versuche?, VFDB 27(1978), Heft 4, Verlag Kohlhammer, Stuttgart
- /5/ SCHNEIDER, U., Einfluß der Umfassungsbauteile auf die Brandentwicklung in Industriehallen, Studiengesellschaft für Anwendungstechnik (Hrsg.), BMFT BAU 6004/Akt.1.2, Düsseldorf 1982
- /6/ HÖNIG, O., KLINGSCH, W., WITTE, H., Interaktion Brand-Konstruktion bei eingeschossigen Hallen, Studiengesellschaft für Anwendungstechnik, BMFT BAU 6004/Akt.3.5, erscheint 1986
- /7/ WITTE, H., Versagen von Stahltrapezprofilen unter Brandbelastung, noch unveröffentlicht

Sheet Steel – Mineral Wool Fire Protection of Steel Columns

Protection contre le feu au moyen de tôle d'acier et de laine minérale

Brandschutztechnische Verkleidung aus Mineralwolle
mit Stahlblechummantelung

Ulla-Maija JUMPPANEN

Civil Engineer
Technical Research Centre
Espoo, Finland



U.-M. Jumppanen, born 1940, received her civil eng. degree at University of Technology Helsinki; has since 1980 been involved in fire-technical problems.

Juha PAAVOLA

Civil Engineer
Technical Research Centre
Espoo, Finland



Juha Paavola, born 1950, received his civil eng. degree at University of Technology Helsinki; has since 1981 been involved in fire-technical problems.

SUMMARY

The paper summarizes the results of fire tests of steel columns protected by various number of mineral wool layers separated by aluminium foils and covered by sheet steel box. The influence of different fixing methods and the cracks appearing in the corners of the columns of the efficiency of the protection system were studied. The efficiency of different protection systems is compared by the aid of virtual thermal resistances. The aim of the study was to develop a box type fire protection system which could be fabricated industrially to ensure better quality and lower costs.

RÉSUMÉ

Cet article rend compte des résultats obtenus lors d'essais de protection contre le feu effectués sur des colonnes en acier protégées par un certain nombre de couches de laine minérale séparées par des feuilles d'aluminium et revêtues d'une gaine en tôle d'acier. L'effet sur l'efficacité du système de protection de diverses méthodes de fixation et de fissures qui apparaissent dans les coins des colonnes est également étudié. La comparaison de l'efficacité des divers systèmes de protection s'est faite à l'aide de résistances thermiques virtuelles. Le but de cette étude était de mettre au point un système de protection contre le feu du type «à gaine» qui puisse être fabriqué de façon industrielle en vue d'en améliorer la qualité et d'en réduire le coût.

ZUSAMMENFASSUNG

Berichtet wird über Brandversuche an Stahlstützen, die mit mehreren jeweils durch Aluminiumfolien getrennte Mineralwollschichten und einem Mantel aus Stahlblech verkleidet waren. Untersucht wurde der Einfluss verschiedener Befestigungsarten sowie die Auswirkung von Rissen, die während der Brandprüfung in den Eckbereichen entstehen. Die Wirksamkeit der verschiedenen Systeme wurde verglichen mit Werten, die nach der Methode der virtuellen thermischen Widerstände errechnet worden sind. Ziel der Untersuchungen war es, eine Ummantelung zu entwickeln, die in hoher Qualität wirtschaftlich hergestellt werden kann.



1. INTRODUCTION

The aim of the production development project considered was to find out such a mineral wool fire protection system for steel columns, which would meet the requirements corresponding to different fire resistance times. The primary demand imposed for the structure was to be industrially fabricated to ensure better quality of the product and lower costs of workmanship.

Galvanized steel sheet casing systems containing different combinations of mineral wool of various densities, air gaps and aluminium foils dividing the mineral wool into multiple layers were selected and investigated experimentally. The effect of the fixing method of insulation layers (mechanical or gluing) as well as the painting of steel columns and steel boxes with paints lowering the emissivity were also examined. The protection systems assembled using mineral wool sheets imbricated in the corners were compared with those made by wrapping the mineral wool layers and aluminium foils around the steel column.

This kind of casing protection system consisting of mineral wool insulation fixed already in the factories into two halves of steel sheet boxes and locked together at the building site was chosen by the reason of before mentioned advantages. In addition the compact protection system is also easy to be transported and mounted at the building site. Covering steel sheets protect the light-weight insulation layers from damages during storing, transportation, building and usage.

The experimental work was carried out in the Fire Technology Laboratory of the Technical Research Centre of Finland and was sponsored by the steel company Rautaruukki Oy and mineral wool manufacturer Oy Partek Ab.

2. EXPERIMENTAL WORK

2.1 Test specimens

The steel columns used were steel tubes Fe 44 D with dimensions of $200 \times 200 \text{ mm}^2$ and wall thickness 10 mm . The length of columns varied from 2300 mm to 3200 mm . One of the most slender load-bearing column types ($F/V \approx 100 \text{ m}^{-1}$) was selected for tests in order to find out the most critical case. Altogether 28 columns were tested. The cross sections of the columns with insulation layers are presented in Fig. 1.

The insulation consisted of two kinds of mineral wool layers, the light one with density of 40 kg/m^3 and the heavier with density of 140 kg/m^3 . The different mineral wool layers were separated by aluminium foils with thickness of 0.04 mm to reduce the heat convection and radiation through insulation layers, which has significant influence in heat transfer for example in case of lightweight insulations. The aluminium foils were either glued onto the mineral wool sheets or they were wrapped around the column between different insulation layers. The outermost mineral wool layer was fixed to the steel sheet either mechanically by steel nails welded on the steel sheet casing or by silicate glue (1.2 kg/m^2).

The covering steel box was made of hot zincd steel sheets with thickness of 1.0 mm . The two halves of the box were locked to each other in the corners and additionally screwed.

Steel tube and the inner surface of the steel sheet box were painted with silicon-aluminium paint to reduce the emissivity and increase the surface thermal resistance.

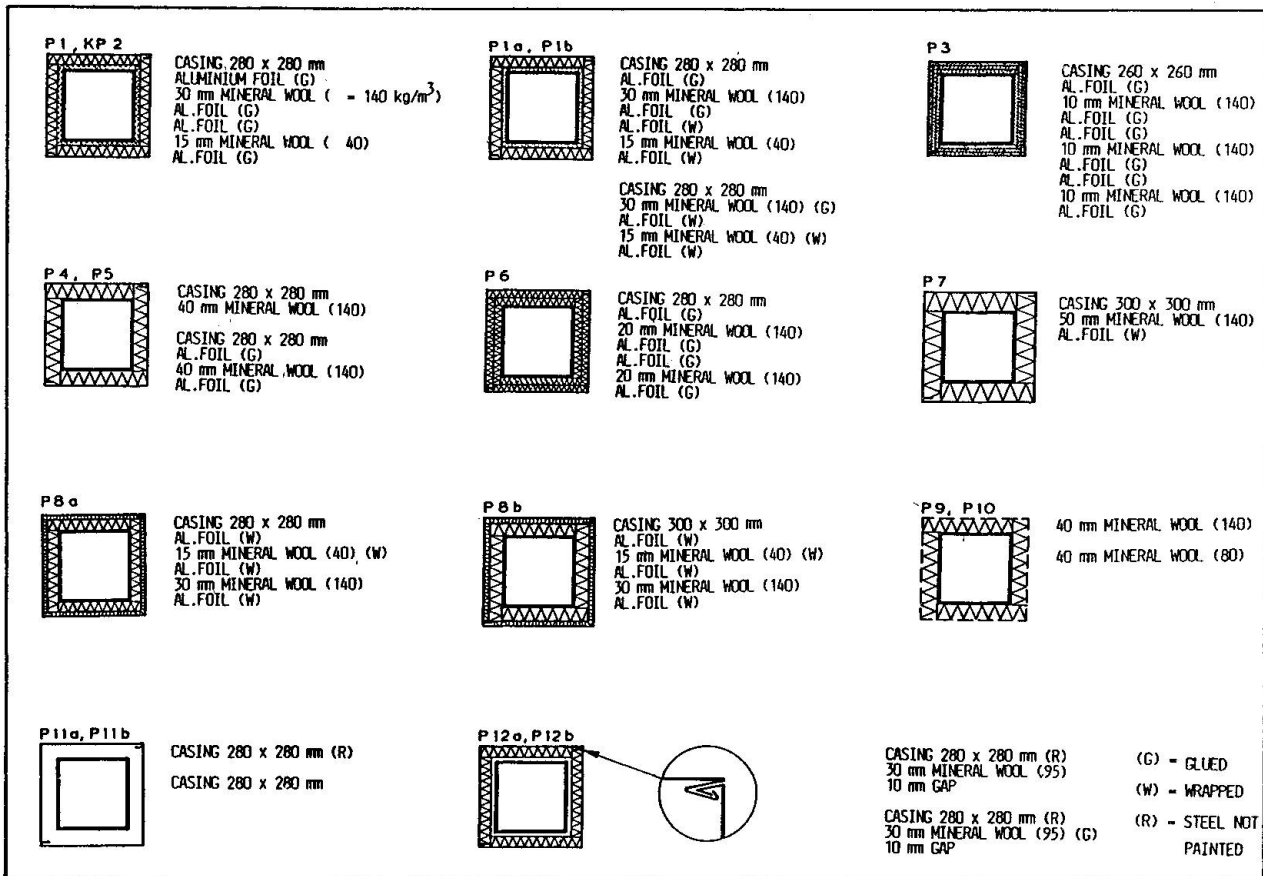

Fig. 1. Cross sections of the columns

2.2 Test arrangements

The tests were performed according to the international testing standard ISO 834. The columns were mounted vertically inside the furnace and tested unloaded (Fig. 2a) Four of the tests were carried out so that the column passed through the ceiling and the bottom of the furnace (Fig. 2b) in order to find out the cooling effect of the penetration.

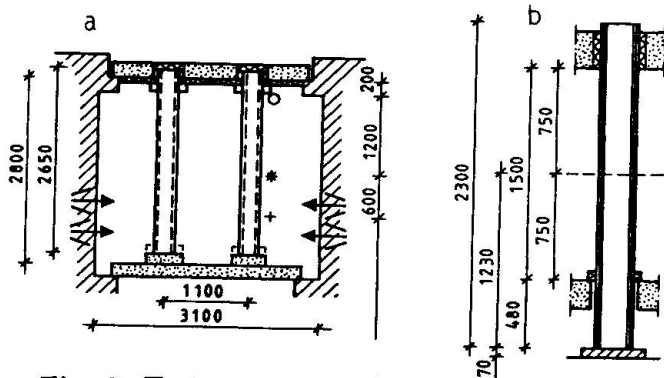

Fig. 2. Test arrangements

3. THE VIRTUAL HEAT RESISTANCE

3.1 Heat conduction model

The problem can be approximated mathematically as a one-dimensional heat conduction problem in the region $0 \leq x \leq L$ with unit area, in which L is the total thickness of insulation layers. The initial temperature T_0 is the temperature of the environment and the

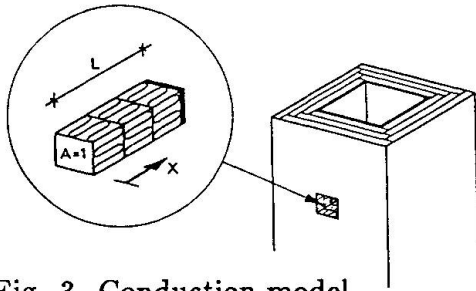

Fig. 3. Conduction model

temperature in the furnace $T_1(t)$ follows the standard time-temperature fire curve (ISO 834). Due to the symmetry of the structure the heat flow is assumed to be one-dimensional. The heat is transferred to the surface of the casing by convection and radiation and flows through the insulation layers to the steel column which is assumed to be in perfect thermal contact with the insulation.

The mathematical formulation of the problem is

$$\frac{\partial}{\partial x} \left(k^{(i)} \frac{\partial T}{\partial x} \right) = \rho^{(i)} c^{(i)} \frac{\partial T}{\partial t}, \quad 0 \leq x \leq L, \quad t \geq 0 \quad (1)$$

with the initial condition

$$T(x, 0) = T_0 \quad (2)$$

and the boundary conditions

$$k^{(i)} \frac{\partial T}{\partial x} = h(T_1(t) - T) \quad \text{at } x = 0 \quad (3)$$

$$k^{(i)} \frac{\partial T}{\partial x} + \rho^{(s)} c^{(s)} \delta^{(s)} \frac{\partial T}{\partial t} = 0 \quad \text{at } x = L \quad (4)$$

In Eqs. k , ρ and c are material properties conductivity, density and specific heat, respectively, h is the heat transfer coefficient at the outer surface of the structure and δ is the wall thickness of the steel column. The superscripts i and s correspond to the insulation material and steel, respectively.

The test results showed that the difference between the temperature of the casing and the temperature of the furnace was very small after some first minutes of the test, so the boundary condition (3) could be replaced by the condition of equality of the temperatures of the casing and the furnace.

3.2 Calculation of virtual heat resistance

In the structure considered the heat flow is directed towards the steel column through various insulation layers. These layers and the outer surface of the structure (emissivity etc.) constitute a resistance for the heat flow. This resistance describes very well the efficiency of the insulation system. The resistance can be determined for separate insulation layers or for the total system. It is defined at $x = x_j$ for the insulation layer with thickness δ by the equation

$$R_j = \frac{\delta^{(i)}}{k^{(i)}} = \frac{\delta^{(i)} \frac{\partial T}{\partial x}}{\dot{q}(x_j, t)} \quad (5)$$

in which $\dot{q}(x_j, t)$ is the heat flow through the surface considered.

The heat resistance of the insulation layer between coordinates (x_j, x_{j-1}) is calculated at the time $t = t_m$ using the scheme

$$R_j = \frac{(T_j^m - T_{j-1}^m) \cdot \Delta t}{\sum_{k=j+1}^N \frac{1}{2} \rho_k^{(i)} c_k^{(i)} \delta_k^{(i)} (T_k^m - T_k^{m-1} + T_{k-1}^m - T_{k-1}^{m-1}) + \rho^{(s)} c^{(s)} \delta^{(s)} (T_s^m - T_s^{m-1})} \quad (6)$$

in which the superscript m of the temperature T corresponds to the time t_m and subscripts j and s to the coordinate x_j and to steel, respectively. The total number of insulation layers is N .

4. TEST RESULTS

The influence of different insulation systems on the thermal behaviour of the columns can be seen in Figs. 4-12 which present either the steel temperatures or the heat resistance of various fire protection systems.

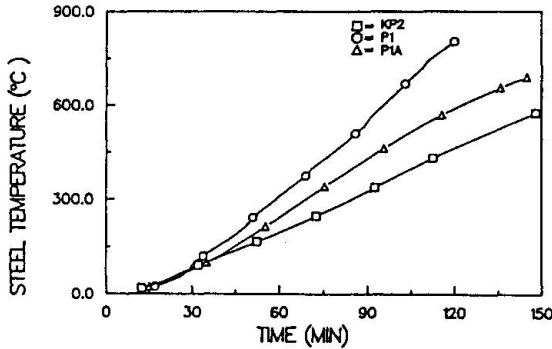

Fig. 4. Steel temperature vs. time

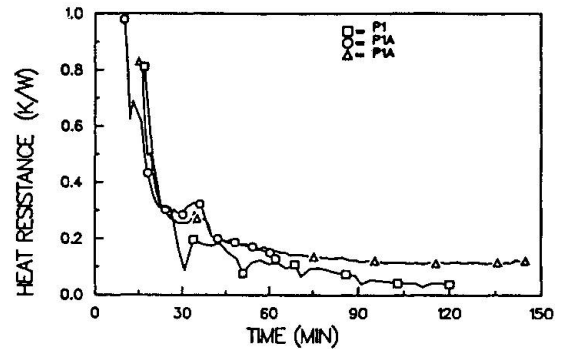

Fig. 5. Heat resistance vs. time

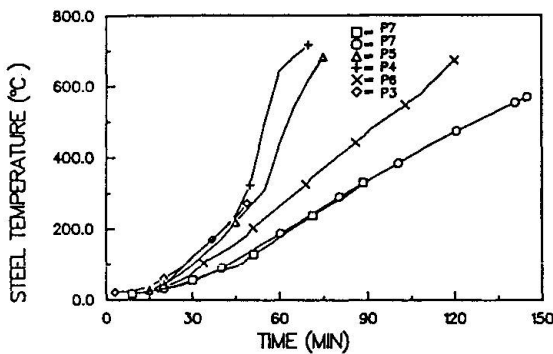

Fig. 6. Steel temperature vs. time

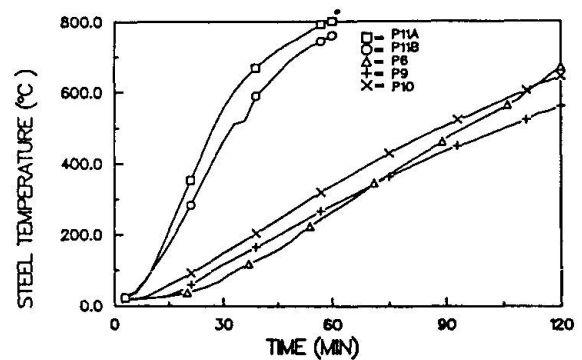

Fig. 7. Steel temperature vs. time

Fig. 4 shows the effect of the assemblage of the column. The column KP2 passed through the ceiling and the bottom of the furnace in the test and the column P1 with similar insulation was mounted totally inside the furnace. The difference in the steel temperature is significant.

Fig. 5 describes the difference between the imbricating (P1) and wrapping (P1A) of the innermost insulation layer by the aid of the virtual heat resistance of the total protection system. The same effect is to be seen in Fig. 4 showing the respective steel temperatures.

The influence of the thickness of the imbricated mineral wool protection and the aluminium foils dividing the mineral wool into several layers can be seen in Fig. 6. The steel temperatures of the columns P3 and P6 where mineral wool was divided into layers show the beneficial influence of the aluminium foils reducing the heat transfer by convection and radiation. The influence of steel sheet box comes apparent in Fig. 7. The steel temperature show that the column protected only with the casing (P11A, P11B) can reach the fire resistance time of 30 min. The casing retards the steel temperature rise, which can also be seen when comparing the steel temperatures of wool insulated columns with casing (P6) and without (P9, P10).

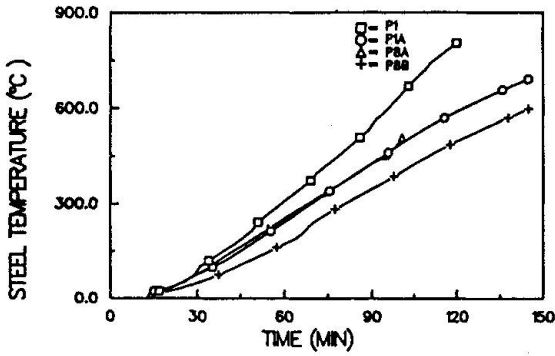

Fig. 8. Steel temperature vs. time

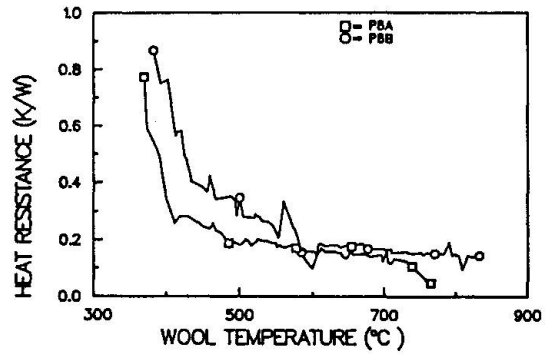

Fig. 9. Heat resistance vs. average temperature

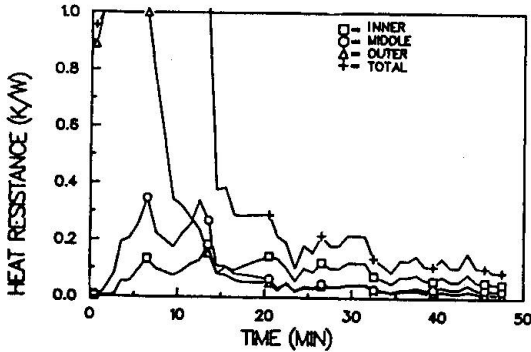

Fig. 10. Heat resistance vs. time

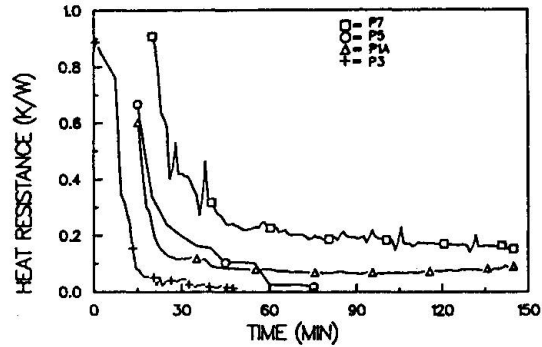

Fig. 11. Heat resistance vs. time

In the columns P1A and P8A the light and heavy mineral wool layers were located in the reverse order. This had no influence on the steel temperature as can be seen in Fig. 8. When the same insulation layers were packed looser in the bigger casing the steel temperature rise was considerably lower (P8A, P8B). The virtual heat resistance curves which were calculated from the experimental data show the same effect in Fig. 9.

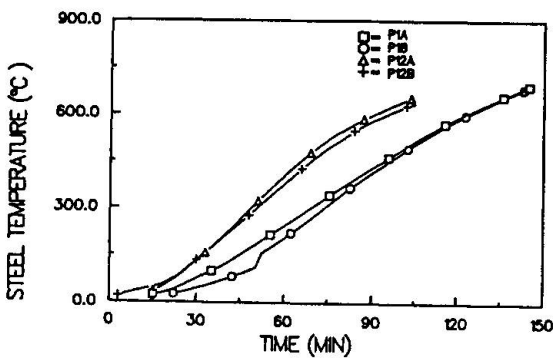

Fig. 12. Steel temperature vs. time

Fig. 10 depicts the function of the insulation system (P3) by the aid of heat resistance curves. At first the outermost layer is activated and after certain time the inner ones begin to act.

The heat resistances of the outermost mineral wool layers having different thicknesses are presented in Fig. 11. Fig. 12 shows that the type of fixing the outermost mineral wool (mechanical ↔ gluing) has only a minimal influence on the development of steel temperatures.

5. CONCLUSIONS

Test results show that best results concerning fire resistance can be obtained when using a system composed of a wrapped layer of light mineral wool combined with a heavier one. Wrapping prevents the formation of critical cracks in the corners of the insulation casing and retards so the heat transfer by convection. Sequential arrangement as well as number of different layers and aluminium interlayers and the painting of the steel tube respectively the interior of the steel sheet box are of minor importance. The type of fixing the mineral wool to the casing has nearly no influence. Although the steel sheet casing reduces convection and heat transfer a little, it practically does not extend the fire resistance time.