

Non-linear behaviour of thin-walled sections

Autor(en): **Moore, David**

Objektyp: **Article**

Zeitschrift: **IABSE reports = Rapports AIPC = IVBH Berichte**

Band (Jahr): **49 (1986)**

PDF erstellt am: **23.07.2024**

Persistenter Link: <https://doi.org/10.5169/seals-38279>

Nutzungsbedingungen

Die ETH-Bibliothek ist Anbieterin der digitalisierten Zeitschriften. Sie besitzt keine Urheberrechte an den Inhalten der Zeitschriften. Die Rechte liegen in der Regel bei den Herausgebern.

Die auf der Plattform e-periodica veröffentlichten Dokumente stehen für nicht-kommerzielle Zwecke in Lehre und Forschung sowie für die private Nutzung frei zur Verfügung. Einzelne Dateien oder Ausdrucke aus diesem Angebot können zusammen mit diesen Nutzungsbedingungen und den korrekten Herkunftsbezeichnungen weitergegeben werden.

Das Veröffentlichen von Bildern in Print- und Online-Publikationen ist nur mit vorheriger Genehmigung der Rechteinhaber erlaubt. Die systematische Speicherung von Teilen des elektronischen Angebots auf anderen Servern bedarf ebenfalls des schriftlichen Einverständnisses der Rechteinhaber.

Haftungsausschluss

Alle Angaben erfolgen ohne Gewähr für Vollständigkeit oder Richtigkeit. Es wird keine Haftung übernommen für Schäden durch die Verwendung von Informationen aus diesem Online-Angebot oder durch das Fehlen von Informationen. Dies gilt auch für Inhalte Dritter, die über dieses Angebot zugänglich sind.

Non-Linear Behaviour of Thin-Walled Sections

Comportement non linéaire des profilés à parois minces

Nicht-lineare Verhalten von dünnwandigen Bauteilen

David MOORE

Senior Scientific Officer
Building Research Establishment
Garston, Watford, UK

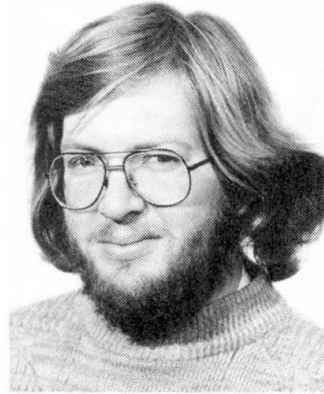

David Moore, born 1956, earned his civil engineering degree at the University of Bradford and joined the Building Research Establishment in 1981. He is engaged in steelwork research and is currently investigating the stability of thin-walled members and the behaviour of beam-column connections.

SUMMARY

The paper examines theoretically and experimentally the influence of practical loading and warping restraint on the behaviour of thin-walled members. It is shown that loads which pass through the shear centre but which are not parallel to a principal axis do not produce pure bending. Furthermore, such loads can reduce the load at which instability occurs. It is also shown that warping restraint has a significant effect on instability.

RÉSUMÉ

Cette contribution concerne une étude théorique et expérimentale de l'influence des conditions réelles de mise en charge et d'appui résistant au gauchissement des profilés à parois minces. Il est montré que les charges qui sont appliquées au centre de cisaillement mais qui ne sont pas parallèles à un axe principal d'inertie ne provoquent pas une flexion uniaxiale. De plus, un tel chargement peut diminuer le niveau de la charge à laquelle l'instabilité se produit. Il est montré également que le gauchissement empêché a un effet déterminant sur la stabilité de l'élément.

ZUSAMMENFASSUNG

Der Einfluss der praktisch auftretenden Belastung und der Wölbbehinderung auf das Verhalten von dünnwandigen Bauteilen wird theoretisch und experimentell untersucht. Es wird festgestellt, dass Lasten, die durch den Schubmittelpunkt eines Bauteils gehen, aber nicht parallel zu einer Hauptachse sind, nicht nur reine Biegung verursachen. Solche Lasten können auch die kritische Last reduzieren (Instabilität). Es wird auch nachgewiesen, dass die Einschränkung der Wölbverformung eine bedeutende Einwirkung auf die Instabilität hat.



1. INTRODUCTION

Cold-formed, thin-walled members of open cross-section are now extensively used in building practice either as purlins or as sheeting rails. As these sections provide a more economical use of material than traditional hot-rolled sections their use as primary structural members is being investigated by some manufacturers. However, the thinness of the material used in manufacture and the process by which they are formed result in sections which have low torsional properties and only one or no axes of symmetry. The analysis of such sections is considerably more complex than that of traditional hot-rolled sections as they are prone to bi-axial bending and various modes of instability. Thus it is not surprising that very few reports have appeared on either the elastic behaviour or the stability of these sections.

There are many factors which influence the behaviour of cold-formed, thin-walled members, the major ones of which are:

- (a) The geometrical properties of the section.
- (b) The type and position of the boundary conditions.
- (c) The type and position of the applied load.
- (d) Material properties.

Of these, comparatively little work has been carried out on the type and position of both the applied load and boundary conditions. In particular the influence of load position, orientation of the load to the principal axes and the effects of warping restraint on the instability of mono-symmetric and asymmetric sections have received little attention.

The effect of loads positioned above and below the shear centre has been investigated by Anderson and Trahair[1] for mono-symmetric sections. They concluded that loads positioned above the shear centre decrease the load at which instability occurs while those below increase it. However, in the case of asymmetric sections, the load is both eccentric to the shear centre and, in general, not parallel to a principal axis. The latter results in additional torsional moments in the member which increase with increased displacement and can have a significant effect on the behaviour and the stability of the section.

Nethercot and Rockey[2] investigated the effects of different boundary conditions on the stability of thin-walled members and concluded that for light-gauge sections warping restraint has a significant influence on the buckling load. Furthermore, they showed that its stabilizing influence lies between that of a simple support and a fully fixed support. They also showed that warping restraint has a more pronounced effect on stocky sections. This work, however, was derived for sections with one or more axes of symmetry and little experimental work exists for asymmetrical members.

This paper, therefore, presents a theoretical and experimental investigation into the effects of load orientation and warping restraint on the behaviour of cold-formed, thin-walled asymmetrical sections of different length.

2. THEORY

When considering the behaviour of a member it is usually assumed that the line of action of the loads relative to the principal axes of the member remains unaltered, even under loading.

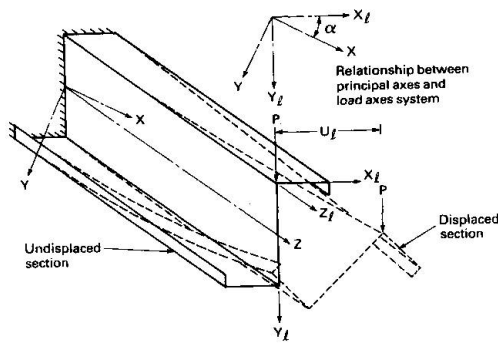

If, as shown in Figure 1, the line of action of the load is inclined to the principal axes then the load moves relative to both the supports and the displaced principal axes. This generates additional torsional forces in the member which increase with increased deflection and have a marked influence on the behaviour of the member. By defining an additional axes system (X_1, Y_1, Z_1) which is coincident with the direction of the applied loads, as shown in Figure 1, Moore[3] derived the following equations which include the additional torsional moments:

Fig. 1 Typical movements of the applied load

$$EI_x \cdot V_{,zz} = -M_x(\cos\alpha + \beta \cdot \sin\alpha) - M_y(-\sin\alpha + \beta \cdot \cos\alpha) + T_z \cdot U_{,z}$$

$$EI_y \cdot U_{,zz} = M_x(-\beta \cdot \cos\alpha + \sin\alpha) + M_y(\beta \cdot \sin\alpha + \cos\alpha) - T_z \cdot V_{,z}$$

$$GC \cdot \beta_{,z} - EI \cdot \beta_{,zzz} = M_x(U_{,z} \cdot \cos\alpha + V_{,z} \cdot \sin\alpha) + M_y(-U_{,z} \cdot \sin\alpha + V_{,z} \cdot \cos\alpha) + T_z + T_d$$

Where M_x, M_y and T_z are the applied loads with respect to the principal X, Y and Z axes and T_d is the additional torsional moment. α is the angle between the principal axes of the member and the additional loading axes system and is shown in Figure 1. All the other terms have their usual meaning.

These equations represent the general expressions for the small displacement behaviour of a beam subject to combined bending and torsion. It is evident that U, V and β are all non-linear functions of the applied load and because of the inclusion of T_d , application of the load through the shear centre is not a sufficient condition to produce pure bending. Indeed pure bending can only occur if the right-hand side of the third equation vanishes. For this to occur, the resultant of the loads must pass through the shear centre and be parallel to a principal axis. When these conditions are fulfilled these equations become uncoupled and reduce to the usual differential equations for bending and torsion.

Expressions for the additional moments, T_d , have also been developed by Moore[3] for a simply supported beam subject to different load distributions and these are quoted below.

(a) eccentric u.d.l

$$T_d(g) = -q/2 \int_0^l (U(z) \cdot \cos\alpha + V(z) \cdot \sin\alpha + e \cdot \beta(z)) dz + q \cdot L (U(z) \cdot \cos\alpha + V(z) \cdot \sin\alpha) \\ + q \int_0^g (U(g) \cdot \cos\alpha + V(g) \cdot \sin\alpha - U(z) \cdot \cos\alpha - V(z) \cdot \sin\alpha) dz$$



where q is the applied load, $U(z)$ and $V(z)$ the displacements of the shear centre in the X and Y directions respectively, β is the rotation of the shear centre and, e , the vertical distance of the load above the shear centre.

(b) central point load

$$T_d(z) = P((U_c - U(z))\cos\alpha + (V_c - V(z))\sin\alpha + e.\beta(z))/2$$

Where P is the applied load and U_c and V_c the displacements of the shear centre in the X and Y directions respectively at mid-span.

(c) point loads at the quarter and three-quarter points

$$T_d(z) = P((U_q - U(z))\cos\alpha + (V_q - V(z))\sin\alpha + e.\beta(z))$$

Where P is the applied load at each of the quarter and three-quarter points and U_q and V_q the displacements of the shear centre in the X and Y directions respectively at the quarter points.

3. EXPERIMENTAL WORK

To assess the influence of the inclination of the load (with respect to the principal axes) and the warping restraint on the behaviour of thin-walled members, and to provide experimental data to verify the proposed theory, a series of tests were carried out on thin-walled cold-formed steel zed sections. A zed section was specifically chosen as its principal axes are naturally inclined to gravity loads. The test rig used for the experiment was designed by Salford University[4] to satisfy, as closely as possible, the following boundary conditions:

- (1) Simple supports about both principal axes
- (2) Restraint from twisting
- (3) Free and fixed warping

This test rig is shown in Figure 2. Because of the inclination of the principal axes of a zed section, it is difficult to devise a system which applies all the boundary conditions. However, by simply supporting any two axes at right-angles, any other two axes at right-angles which lie in the same plane will themselves have simple supports. Thus simply supporting the horizontal and vertical axes is equivalent to applying simple supports to the principal axes. These conditions were achieved by mounting the zed section through its shear centre on a steel bar supported at each end by frictionless bearings and mounting this assembly on a turntable. This arrangement is shown in Figure 3. Rotational fixity and free warping were achieved by attaching light gauge steel brackets to the top and bottom flanges of the section at each support. These brackets restrained the end rotations but allowed the section to warp. Fixed warping was achieved by clamping the section between 12mm thick mild steel plates. These plates were themselves restrained against twisting by the light-gauge steel brackets and are shown in Figure 3.

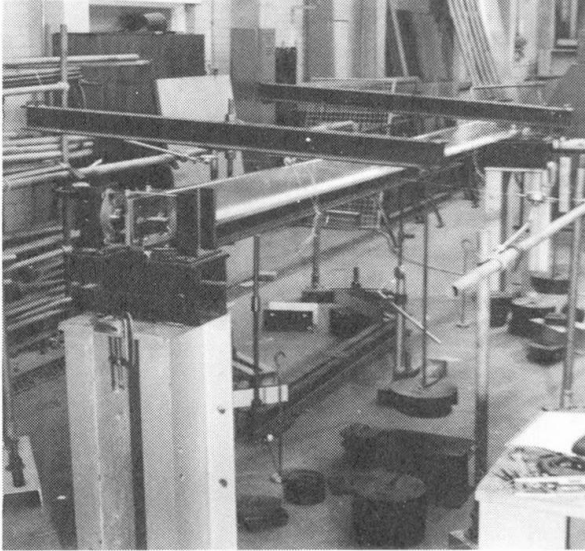

Fig. 2 General view of test rig

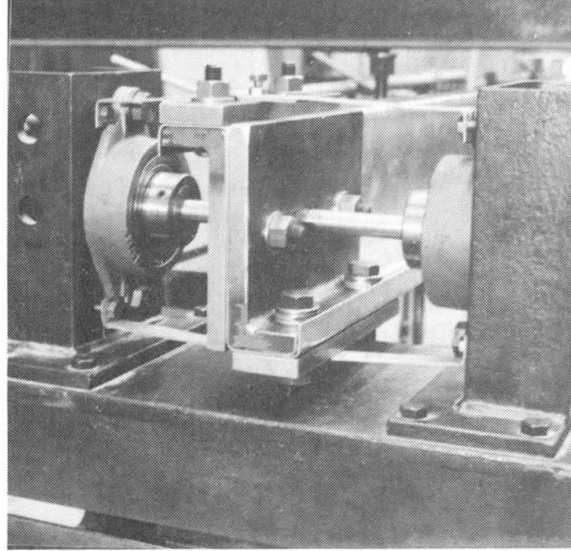

Fig. 3 Boundary conditions

The load was applied to the top flange of the section by means of a lever-arm system as shown in Figure 2. To ensure free movement of the load a roller bearing was placed between the underside of the lever-arm and the load points. With this system the lever-arm changes as the section moves, however, this was allowed for by measuring the horizontal movement of the section at each load point. In this way the actual load applied to the section can be determined from the following equation:

$$\text{applied load} = P \cdot (L_1 + L_2) / (L_1 + \delta)$$

where P is the weight applied to the lever-arm, L_1 and L_2 are the initial distances from the pivot point to the section and from the section to the load respectively and δ is the measured horizontal movement of the section.

Two dial gauges positioned parallel to the top and bottom flanges were used to monitor the horizontal displacement and the rotation of the section at each of the quarter, half and three-quarter points. Additionally a dial gauge was positioned at mid-span to monitor vertical displacement.

Nine tests were carried out on three different lengths (1000mm, 2500mm and 4500mm) of 140*50*1.6mm zed section subject to loads applied at the quarter and three-quarter points with eccentricities of -25mm, 0mm and 25mm from the shear centre. In each case the boundary conditions were simply supported about both principal axes, torsionally fixed and free to warp. Additionally, all three tests on the 2500mm length zed sections and two tests on the 4500mm length zed sections with eccentricities of -25mm and +25mm were repeated but with the warping restrained. In each case the load was incremented at the quarter and three-quarter points until failure occurred.



4. DISCUSSION OF RESULTS

4.1 The effect of load position and inclination

The load deflection characteristics shown in Figure 4 are for a simply supported, torsionally restrained and free warping zed section subject to loads at the quarter and three-quarter points and are typical of those obtained for all the tests identified in section 3. For each test the proposed theory follows the same general trend as the experiment and gives reasonable results for the displacements in the U direction and the rotations β .

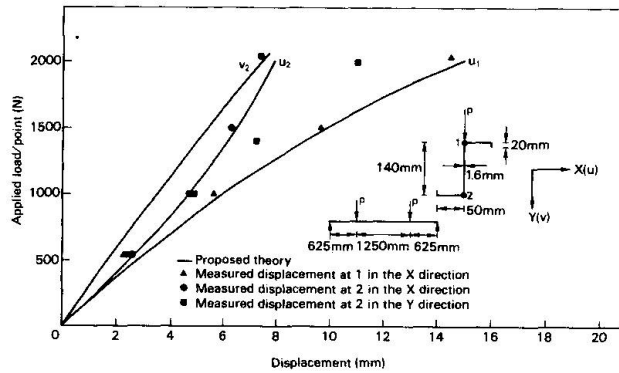

Fig. 4 Simply supported zed section subject to loads at the quarter and three-quarter points

However the theory is in poor agreement with the experimental displacements in the V direction. The reason for this is not clear but it is speculated that it is due to the rotation of the principal axes and the subsequent increase in displacement in the Y direction.

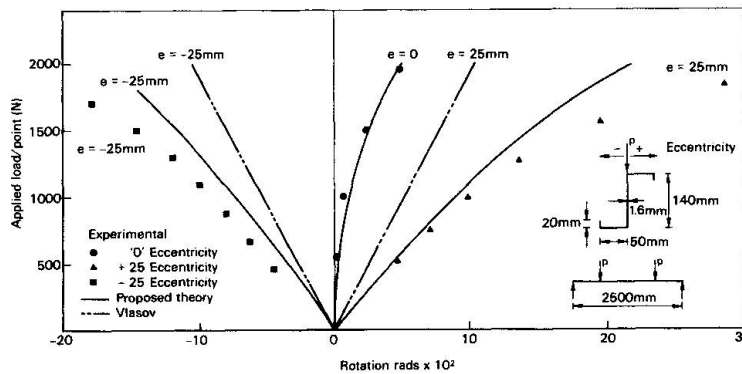

Fig. 5 Comparison between measured and computed rotations for different load eccentricities

Figure 5 shows the load rotation characteristics for the 2500mm long zed section with free warping subject to loads applied at the quarter and three-quarter points with eccentricities of -25mm, 0mm and 25mm. In each case both the

proposed theory and the experiment are non-linear and in good agreement. Also shown in Figure 5 is the theoretical solution of Vlasov[5] which is in poor agreement with both the experimental results and the proposed theory. It is also evident from Figure 5 that with the load through the shear centre ($e=0$) the section still twists.

It is interesting to note that both the proposed theory and the experiment give slightly smaller rotations when the load has a negative eccentricity than when the load has a positive eccentricity. This is due to the additional torsional moments, T_d , which act in the positive direction of β and therefore add to the torsional moments

produced by the loads with positive eccentricities and reduce those with negative eccentricities. This type of behaviour suggests that a combination of load orientation and positive eccentricity may result in a potentially more unstable condition than loads with the same orientation and a negative eccentricity. The experimentally obtained buckling moments for members with different

horizontal eccentricities are shown in Figure 6. Here positive eccentricity give consistently lower buckling moments than loads with negative eccentricities supporting the above argument. The exception to this is the 1000mm long section which gives marginally higher buckling moments for loads with positive eccentricities. It is also evident, from Figure 6, that eccentric loads generally reduce the load at which instability occurs and that this effect is most pronounced for members with low slenderness ratios.

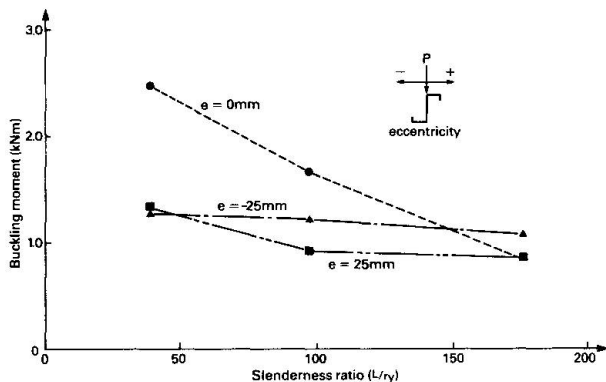

Fig. 6 Variation of buckling load with slenderness ratio and horizontal eccentricity.

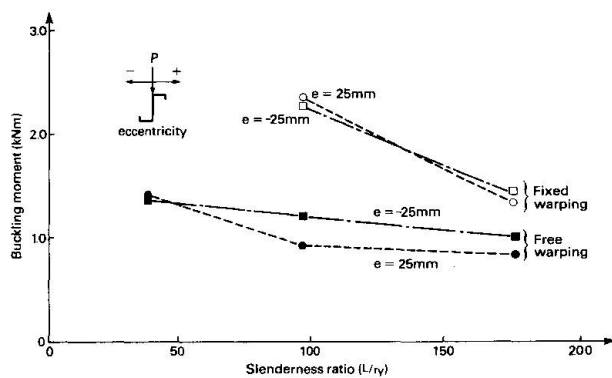

Fig. 7 Influence of warping restraint on buckling moment

4.2 The influence of warping restraint

Figure 7 shows the experimental values of buckling moment plotted against slenderness ratio for sections tested with and without warping restraint. From this limited number of tests it is evident that warping restraint has a significant effect on the buckling load. If the warping is fixed an increase in buckling moment of about 60% is obtained over the same section with free warping. It is also noted that the influence of warping restraint is more pronounced for beams with lower slenderness ratios. Thus an assessment of the warping restraint provided by practical boundary conditions must be made if structures which are either too conservative or unsafe are to be avoided. The Building Research Establishment is currently investigating the warping restraint provided by practical supports.



5. CONCLUSIONS

This paper proposes a non-linear theory for the behaviour of thin-walled members which includes the effect of load position and inclination. The theory is compared with experimental data in which the eccentricity of the load is varied. Additionally, a number of tests were carried out in which the effect of warping restraint on instability is investigated and the following conclusions applicable to unrestrained, simply supported thin-walled beams are drawn:

- (a) The proposed theory and experiment are in reasonable agreement for displacements and rotations.
- (b) Pure bending can only occur if the resultant load passes through the shear centre and is parallel to a principal axis.
- (c) The position and inclination of the load from the principal axes have a significant effect on the behaviour of thin-walled beams.
- (d) Loads above the shear centre, with a positive eccentricity and which are inclined to the principal axes decrease the critical load.
- (e) Warping restraint has a pronounced effect on buckling load.

6. ACKNOWLEDGMENTS

The work described in this paper forms part of the current programme of the Building Research Establishment (BRE). Experimental work forming part of this programme was carried out for BRE at Salford University. This paper is published by permission of the Director, BRE.

7. REFERENCES

1. ANDERSON J M and TRAHAIR N S., Stability of monosymmetric beams and cantilevers. Journal of the Structural Division, ASCE, 98(ST1), Proc paper 8646, 269-86, 1972.
2. NETHERCOT D A and ROCKEY K C., A unified approach to the elastic lateral buckling of beams. The Structural Engineer, July 1971, No. 7, Vol. 49, 321-30.
3. MOORE D.B., A non-linear theory for the behaviour of thin-walled sections subject to combined bending and torsion. In press.
4. LEACH P., Buckling behaviour of light gauge steel beams. Private report for the Building Research Establishment, 1985.
5. VLASOV V Z., Thin-walled elastic beams. Israeli programme for scientific translations, Jerusalem, 1961.