

**Zeitschrift:** IABSE reports = Rapports AIPC = IVBH Berichte

**Band:** 60 (1990)

**Artikel:** Three-dimensional carbon fabric reinforced concrete

**Autor:** Amano, Reiko / Ohno, Toshio / Imadate, Fumio

**DOI:** <https://doi.org/10.5169/seals-46551>

### **Nutzungsbedingungen**

Die ETH-Bibliothek ist die Anbieterin der digitalisierten Zeitschriften. Sie besitzt keine Urheberrechte an den Zeitschriften und ist nicht verantwortlich für deren Inhalte. Die Rechte liegen in der Regel bei den Herausgebern beziehungsweise den externen Rechteinhabern. [Siehe Rechtliche Hinweise.](#)

### **Conditions d'utilisation**

L'ETH Library est le fournisseur des revues numérisées. Elle ne détient aucun droit d'auteur sur les revues et n'est pas responsable de leur contenu. En règle générale, les droits sont détenus par les éditeurs ou les détenteurs de droits externes. [Voir Informations légales.](#)

### **Terms of use**

The ETH Library is the provider of the digitised journals. It does not own any copyrights to the journals and is not responsible for their content. The rights usually lie with the publishers or the external rights holders. [See Legal notice.](#)

**Download PDF:** 07.10.2024

**ETH-Bibliothek Zürich, E-Periodica, <https://www.e-periodica.ch>**

## Three-dimensional Carbon Fabric Reinforced Concrete

Renforcement du béton par un tissu de carbone tridimensionnel

Bewehrung von Beton mit drei-dimensionalen Geflechten  
aus Kohlefasern

### Reiko AMANO

Res. Engineer  
Kajima Inst. of  
Tokyo, Japan

### Toshio OHNO

Res. Engineer  
Kajima Inst. of  
Tokyo, Japan

### Fumio IMADATE

Senior Res. Engineer  
Constr. Technology  
Tokyo, Japan

### Yoichi NOJIRI

Assist. Dir.  
Constr. Technology  
Tokyo, Japan

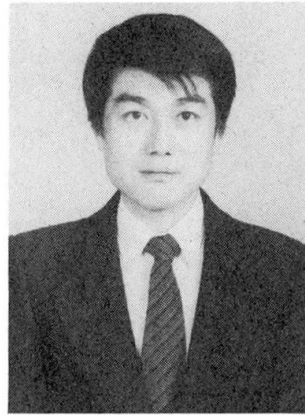
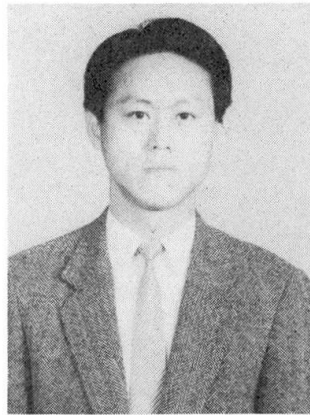
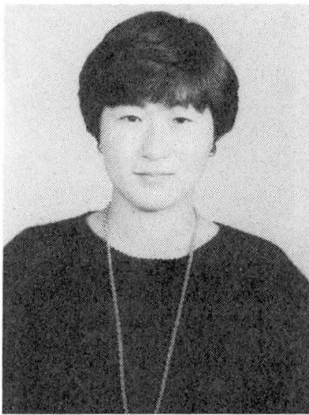

### SUMMARY

The possibility of replacing steel reinforcing bars by three-dimensional carbon fabric reinforced plastics is introduced together with experimental results. This new material is a three-dimensional lattice made of rovings of carbon fiber, manufactured by weaving them into three perpendicular directions and impregnated with epoxy resin. The mechanical properties of this reinforced concrete were studied and tests were carried out on the models of side walls of a typical elevated highway structure where an early deterioration due to effects of exhaust from vehicle, deicing salts and so on is serious.

### RÉSUMÉ

La possibilité de renforcement du béton par un tissu de carbone tridimensionnel à la place de barres d'armature est présentée avec des résultats expérimentaux. Ce nouveau matériau est fabriqué en tissant des fibres de carbone dans trois directions perpendiculaires, et en l'imprégnant de résine époxy. Les propriétés mécaniques du béton renforcé ont été étudiées et des essais ont été effectués sur des échantillons de voiles latéraux d'un pont-route typique et élevé, présentant une sérieuse détérioration prématurée due aux gaz d'échappement d'automobiles, aux sels de dégel etc.

### ZUSAMMENFASSUNG

Dieser Beitrag behandelt die Möglichkeiten, einer Bewehrung mit drei-dimensionalen Geflechten auf Kohlefasern und gibt Versuchsergebnisse bekannt. Dieses neue Material ist ein drei-dimensionales Fachwerk aus Bündeln von Kohlefasern, die in drei senkrechten Richtungen verwoben und mit Epoxy Harz durchdrungen werden. Die mechanischen Eigenschaften des damit bewehrten Betons wurden untersucht. Versuche wurden an Modellen von Stützmauern typischer Hochstrassen durchgeführt, wo infolge der Einflüsse der Fahrzeugabgase, des Tausalzes usw. eine relativ starke Zersetzung stattfindet.



## 1. INTRODUCTION

Recently, an early deterioration of steel reinforced concrete structures due to chloride attack, etc., has been becoming a serious problem in Japan. Countermeasures are urgently required, in particular, in coastal zones where structures are being damaged by the heavy corrosion of steel bars. Under these circumstances, Fiber Reinforced Plastics (FRP) rods manufactured by impregnating various fibers with resin are attracting attention due to their potential for a concrete reinforcing material free from corrosion. Tests were performed on the models of side walls of typical elevated highway structures, which were reinforced with 3D-CF for the purpose of investigating the mechanical properties of 3D-CF reinforced concrete.

## 2. THREE-DIMENSIONAL FABRIC(3D-F)

The 3D-F [1][2][3] is a three-dimensional lattice made of rovings of fibers, manufactured by weaving into three perpendicular directions and impregnated with epoxy resin. This allows a flexible choice in fiber material of the rovings (PAN-base carbon fiber was used in the tests, the properties of which are shown in Fig.1), the number of filaments per roving, and the spacing between the rovings. A mechanical bond strength between the 3D-F and concrete is high because of the latticed pattern of the materials. Efficient production is also possible since three-dimensional weaving, impregnation of resin, and hardening can all be carried out by an automatic weaving machine. Fig.2 shows a sample of the 3D-CF.

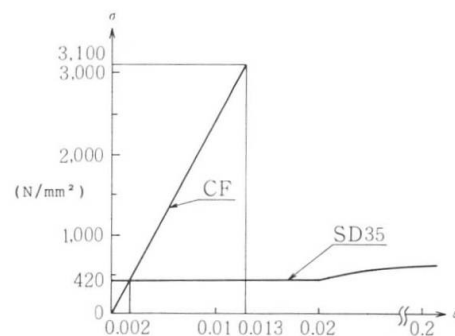

**Fig.1** Stress-strain diagram of CF and steel

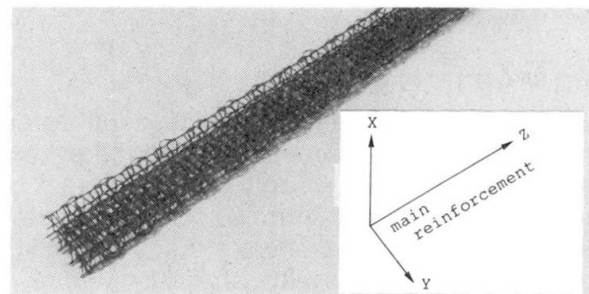
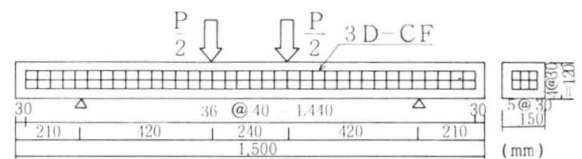

**Fig.2** Sample of 3D-CF

## 3. EXPERIMENTAL RESEARCH

### 3.1 Flexural Properties

Fig.3 profiles the specimens and the arrangement of reinforcements, with parameters representing the number of filaments per roving in the X, Y and Z directions (the Z direction is the direction of main reinforcement) and the spacing between rovings in the X and the Y directions. The test specimens were subjected to two-point loadings. All 3D-CF reinforced concrete (3D-CFRC) specimens failed in breaking of axial reinforcements. The test results are shown in Fig.4. The flexural strength



parameters of specimens

specimen	number of filaments			spacing (mm)		
	X	Y	Z	X	Y	Z
F-1	48 K	48 K	96 K	40	40	30
F-2				90	90	
F-3				40	40	
F-4	24 K	24 K	48 K	60	60	
F-5				90	90	
F-6				360	360	
F-7	24 K	24 K		40	40	
F-8	12 K	12 K	24 K	40	40	
F-9				90	90	

**Fig.3** Specimens for the flexural tests

which is calculated by conventional theory of steel reinforced concrete (the RC theory, [4][5]) is shown by solid line. The observed values are equal to or a little greater than the calculated values. In Fig.5, the observed and the calculated moments are shown in relation to the curvature. The calculated moments are shown for three cases, (1) where the total section is assumed to be effective; (2) where the rigidity is calculated taking an effect of the rigidity of tensile zone into consideration; and (3) where the rigidity of tensile zone is neglected. The observed values show agreement with the values of case (2). From these results, in the 3D-CFRC beams it was confirmed that the flexural strength and moment-curvature relationship can be estimated by the RC theory taking all the rovings of Z direction into account.

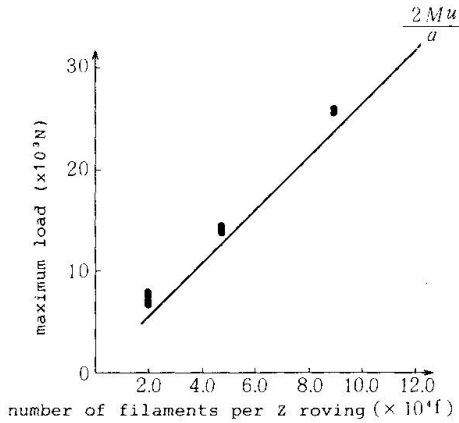

**Fig.4** Maximum load vs. the number of filaments per roving in the Z direction relationship

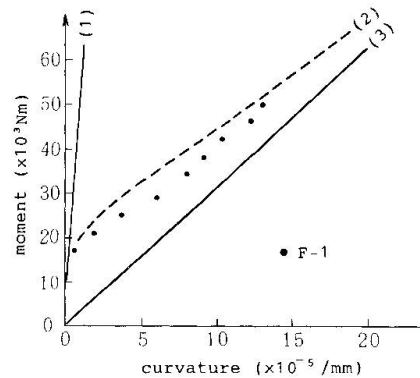

**Fig.5** Moment vs. curvature relationship

**3.2 Shear Properties**

As illustrated in Fig.6, specimens with 3D-CF arranged in the concrete were tested by two-point loadings. Parameters in the tests were the number of filaments per roving and the spacing between rovings in the X and the Y directions.

In all specimens, axial reinforcements broke after diagonal cracking. The test results are shown in Fig.7. In this figure, flexural strength calculated by the RC theory and the shear strength calculated regarding all the Z rovings as the main reinforcement and the X rovings as the shear reinforcement are also shown by solid and broken lines, respectively.

It became clear that the shear strength of the 3D-CFRC beams is greater than the calculated value.

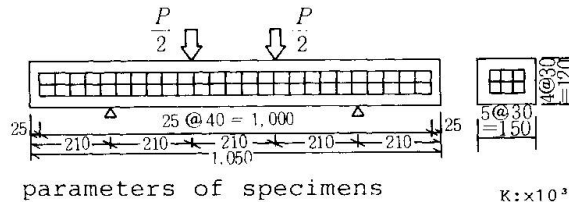

parameters of specimens K: x10<sup>3</sup>

specimen	number of filaments			spacing (mm)		
	X	Y	Z	X	Y	Z
S-1	48 K	48 K	120 K	40	40	30
S-2				90	90	
S-3	24 K	24 K		40	40	
S-4	12 K	12 K		40	40	
S-5				90	90	

**Fig.6** Specimens for the shear tests

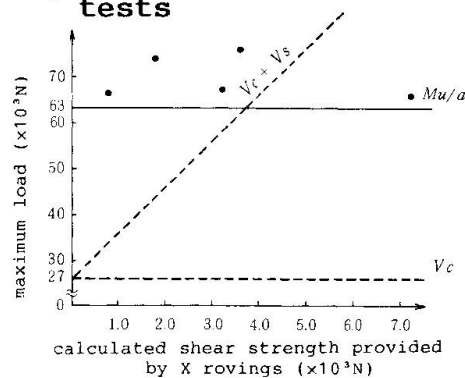

**Fig.7** Maximum load vs. calculated shear strength provided by X rovings relationship

**3.3 Anchorage Performance**

The anchorage performance between 3D-CF and concrete were investigated by using the beams changing the depth of the



cross section which models the corner portion of an L-shaped member as shown in Fig.8. In the tests, the number of layers at the anchorage, the development length and the number of filaments per roving and the spacing between rovings in the X and the Y directions were taken into account as the parameters.

In all specimens, axial reinforcements were slipped out at the anchorage. Fig.9 illustrates the relationship between the development length and the ratio of the bond strength to the square root compressive strength of concrete ( $f_{bo}/\sqrt{f_c'}$ ). The roving diameter is calculated by assuming the section to be circular, and in this calculation periphery of upper rovings is neglected. Fig.9 shows that a longer development length corresponds to a smaller bond stress. And as shown in Fig.9, the bond strength of a two-layer reinforcement is larger than that of a single-layer reinforcement.

It was clear that when 3D-CF is used for the L-shaped member described below, the development length of the 3D-CF can be calculated by assuming a single-layer reinforcement at anchorage.

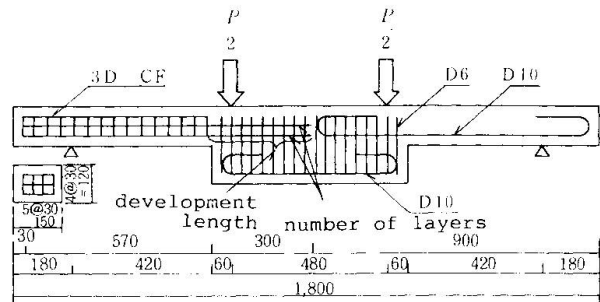

parameters of specimens

specimen	number of filaments			spacing (mm)				
	X	Y	Z	X	Y	Z		
A-1	48 K	48 K	96 K	40	40	30		
A-2				90	90			
A-3							24 K	24 K
A-4				40	40			
A-5				90	90			
A-6				40	40			
A-7	90	90						
A-8			12 K	12 K				
A-9	40	40						
A-10	90	90						
A-11	12 K	12 K	96 K	40	40			
A-12				90	90			
A-13				40	40			
A-14				90	90			
A-15								
A-16								

Fig.8 Specimens for the bond tests

### 3.4 Tests on L-shaped Models

#### 3.4.1 Design Condition of The Side Wall Model

The configuration adopted for the models is an L-shaped member arising 60 cm from the slab surface, which are three fifths models of the side wall of an actual highway structure.

The design loads are collision load and the wind load ( $w = 3000 \text{ N/m}^2$ ,  $1500 \text{ N/m}^2$ ). The design bending moment ( $M_d$ ) is  $14 \times 10^3 \text{ Nm/m}$ . The collision load is applied horizontally at a height of 42 cm from the slab surface.

#### 3.4.2 Steel Reinforced Concrete (RC) Model

The RC model is designed by the above design condition and provided for the test as a reference specimen to be compared with 3D-CFRC models. The flexural and shear resistances of the RC model are:

$$\begin{aligned} \text{Resisting moment } \mu &= 32 \times 10^3 \text{ Nm/m} \\ \text{Moment by shear strength } \nu \cdot a &= 75 \times 10^3 \text{ Nm/m} \end{aligned}$$

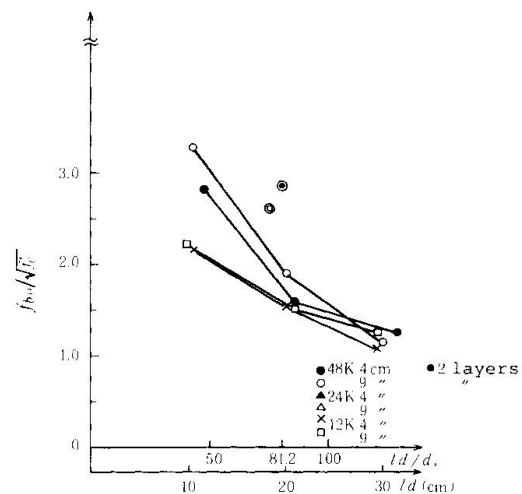

Fig.9 Anchorage strength vs. development length relationship

### 3.4.2 3D-CFRC Models

3D-CFRC models are designed by using the results of the flexural and shear tests. The Z rovings are arranged to retain the larger level of resisting moment as that of the RC model. And rovings in the X and the Y directions are arranged so as to provide larger shear strength than the flexural strength. The flexural and shear resistances calculated by the RC theory are:

$$\begin{aligned} \text{Resisting moment } \mu' &= 40 \times 10^3 \text{ Nm/m} \\ \text{Moment by shear strength } \nu' \cdot a &= 142 \times 10^3 \text{ Nm/m} \end{aligned}$$

Fig.10 profiles the models and the reinforcement arrangements. Three 3D-CFRC models, each consisting of vertical and horizontal 3D-CF units in combination, were tested. In the models, the embedded length of the vertical 3D-CF unit was varied. The embedded lengths were determined by referring the results of the bond tests:

- L-1 ; 10 cm
- L-2 ; 20 cm
- L-3 ; 37 cm

For the model L-1 and L-2, the lapped portion of the vertical and horizontal units was partially bound with CF half-cured ribbon to fix each unit.

### 3.4.3 Test Results

Loads were applied at a point of 42 cm from the slab surface shown in Fig.11. Fig.12 shows the relationship between moment and the deflection obtained from the tests.

As shown in Fig.12, the maximum moment of the model L-2 is equal to the calculated resisting moment, but those of the model L-1 and L-3 are 70% of the resisting moment. Because, in the model L-2 which had the embedded length long enough for the anchorage and bound firmly in the lapped portion, vertical 3D-CFRC axial reinforcements (the Z rovings) were broken. And the model L-1 showed a bond failure due to the short embedded length and the model L-3 showed a bond failure though it had the enough development length determined from the results of the bond tests.

Comparing the deformation characteristics of them with the RC model, in the model L-1 a ductile

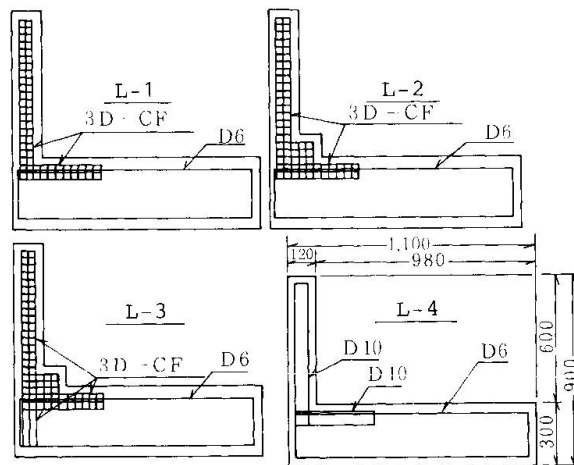

parameters of specimens

specimen	number of filaments			spacing (mm)		
	X	Y	Z	X	Y	Z
L-1	48 K	48 K	.96 K	40	40	30
L-2						
L-3						
L-4		D 10	D 10	120	75	

Fig.10 Test specimens

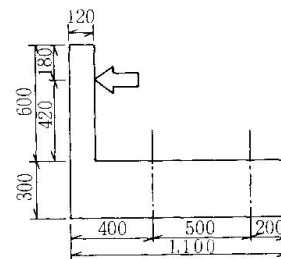

Fig.11 Loading setup

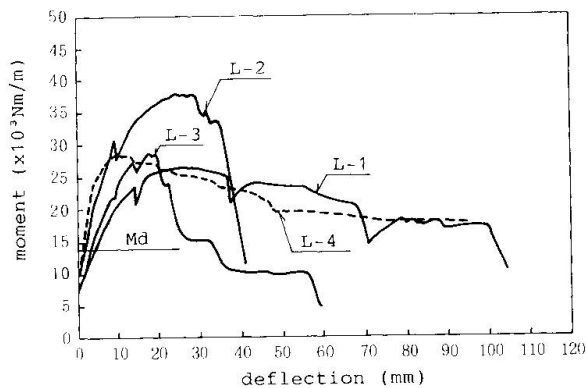

Fig.12 Moment vs. deflection relationship



failure occurred and the amount of deformation is comparable with the RC specimen in which the progressive failure occurred due to breaking of binding ribbons one by one.

From these tests, the ultimate strength of the structure is determined by the arrangement of reinforcing material such as enough embedded length of vertical reinforcement as well as binding of vertical and horizontal units firmly. And 3D-CF can be used as reinforcement of L-shaped members when it is designed and the reinforcing unit is arranged properly.

## 5. CONCLUSIONS

The new anti-corrosive, lightweight material -- Three-Dimensional Carbon Fabric -- was introduced and various test results were presented. 3D-CF, developed to replace an ordinary reinforcing steel bar, a three-dimensional lattice made of rovings of CF, manufactured by weaving into three perpendicular directions and impregnated with epoxy resin, is believed to be one of promising materials to be used for the structures exposed to severe environmental condition.

## REFERENCES

1. H. Nakagawa, S. Akihama, T. Suenaga, Mechanical properties of various types of fibre reinforced concretes, International Concrete on Recent Developments of Fiber Reinforced Cements and Concretes, September 1989.
2. H. Nakagawa, T. Suenaga, S. Akihama, Mechanical properties of three-dimensional fabric reinforced concretes and their application to buildings, First Japan International SAMPE Symposium, November 1989. fibre reinforced concretes, International Concrete on Recent Developments of Fiber Reinforced Cements and Concretes, September 1989.
3. R. Amano, F. Imadate, T. Ohno, Study on three-dimensional carbon fabric reinforced concrete, Annual Report of Kajima Institute of Construction Technology, V01.37, October 1989.
4. Japan Society of Civil Engineers, Standard Specifications for Concrete, 1986.
5. Y. Murayama, K. Suda, K. Furuichi, Moment-curvature relationships of reinforced concrete members subjected to combined bi-axial bending moment and axial force, Annual Report of Kajima Institute of Construction Technology, V01.37, October 1989.