

# Shear strength of beams without shear reinforcement

Autor(en): **Ueda, Tamon / Putro, Heru Darjudi Eko**

Objekttyp: **Article**

Zeitschrift: **IABSE reports = Rapports AIPC = IVBH Berichte**

Band (Jahr): **62 (1991)**

PDF erstellt am: **23.07.2024**

Persistenter Link: <https://doi.org/10.5169/seals-47701>

## **Nutzungsbedingungen**

Die ETH-Bibliothek ist Anbieterin der digitalisierten Zeitschriften. Sie besitzt keine Urheberrechte an den Inhalten der Zeitschriften. Die Rechte liegen in der Regel bei den Herausgebern.

Die auf der Plattform e-periodica veröffentlichten Dokumente stehen für nicht-kommerzielle Zwecke in Lehre und Forschung sowie für die private Nutzung frei zur Verfügung. Einzelne Dateien oder Ausdrucke aus diesem Angebot können zusammen mit diesen Nutzungsbedingungen und den korrekten Herkunftsbezeichnungen weitergegeben werden.

Das Veröffentlichen von Bildern in Print- und Online-Publikationen ist nur mit vorheriger Genehmigung der Rechteinhaber erlaubt. Die systematische Speicherung von Teilen des elektronischen Angebots auf anderen Servern bedarf ebenfalls des schriftlichen Einverständnisses der Rechteinhaber.

## **Haftungsausschluss**

Alle Angaben erfolgen ohne Gewähr für Vollständigkeit oder Richtigkeit. Es wird keine Haftung übernommen für Schäden durch die Verwendung von Informationen aus diesem Online-Angebot oder durch das Fehlen von Informationen. Dies gilt auch für Inhalte Dritter, die über dieses Angebot zugänglich sind.

## Shear Strength of Beams without Shear Reinforcement

Cisaillement des poutres en béton précontraint dépourvues d'étriers

Schubtragfähigkeit von Spannbetonbalken ohne Schubbewehrung

### Tamon UEDA

Assoc. Prof.  
Univ. of Tokyo  
Tokyo, Japan

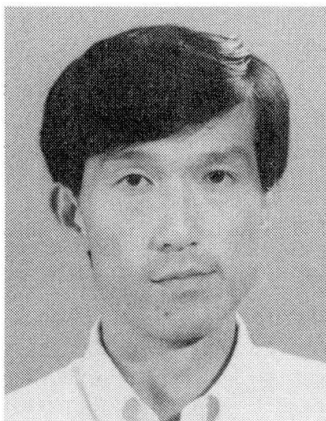

Tamon Ueda, born in 1954, obtained his Doctor of Engineering degree from University of Tokyo in 1982. He served as Assistant and Associate Professor at Asian Institute of Technology. His research interests relate to the deformation mechanism of concrete.

### Heru Darjudi Eko PUTRO

Civil Eng.  
Asian Inst. of Technol.  
Bangkok, Thailand

Heru Darjudi Eko Putro obtained his Master of Engineering degree from Asian Institute of Technology in 1990. Currently he is in a consulting firm in Jakarta.

### SUMMARY

Strengths of shear compression failure in prestressed concrete beams can be predicted by the finite elements method analysis, in which a main shear crack is modelled as a discrete crack. Compression failure of concrete in the maximum moment region causes shear failure of the beams. A narrower compression zone is considered to make the shear strength less than the flexural strength. Force transferred along the main shear crack does not affect the shear strength of the beam too much.

### RÉSUMÉ

La résistance ultime au cisaillement des poutres en béton précontraint peut être prévue à l'aide d'une analyse non-linéaire par la méthode des éléments finis, où chaque fissure de cisaillement est modélisée comme une fissure discrète. La rupture en compression du béton dans la zone de moment maximum est responsable dans les poutres de la ruine par cisaillement. Une zone comprimée plus étroite rend la résistance au cisaillement plus faible que la résistance flexionnelle. La force transmise le long de la fissure principale d'effort tranchant n'a qu'un faible effet sur la résistance au cisaillement de la poutre.

### ZUSAMMENFASSUNG

Die Tragfähigkeit von Spannbetonbalken mit Schubdruckbrüchen kann mit einer Finite Element Berechnung ermittelt werden, bei der ein Hauptschubriss diskret modelliert wird. Betondruckversagen im Bereich des grössten Biegemoments verursacht den Schubbruch. Kleinere Druckzonenhöhen vermindern die Schubtragfähigkeit stärker als die Biegetragfähigkeit. Die Kraftübertragung längs des Hauptschubrisses beeinflusst die Schubtragfähigkeit nur gering.



1. INTRODUCTION

Shear strength of reinforced concrete beams has been clarified by many studies, most of which were of experimental approach. Studies on shear strength of beams subjected to axial force, such as prestressed concrete, however, have not been conducted sufficiently yet. Since the accuracy in the shear strength prediction is poor in the case with axial force, a rational prediction method is urgently required. In this study, therefore, prediction of shear strength of prestressed concrete beams without shear reinforcement was done by a nonlinear finite element method ( FEM ). In the FEM constitutive laws, which have been greatly developed

in recent years, were implemented. As results of the FEM analysis, several interesting and useful points were newly found on the shear strength prediction.

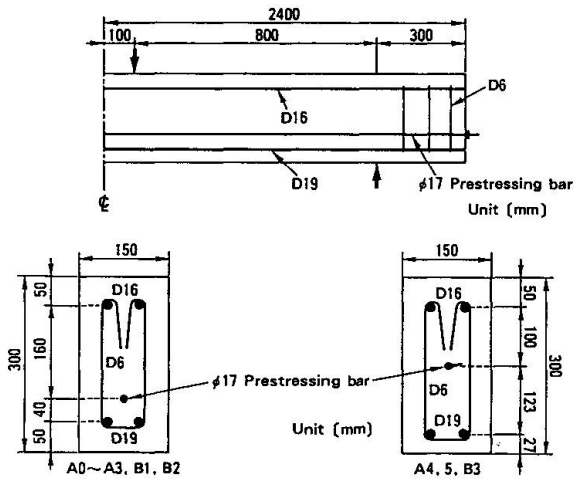
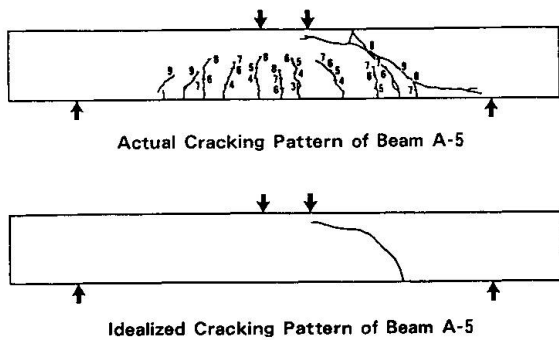
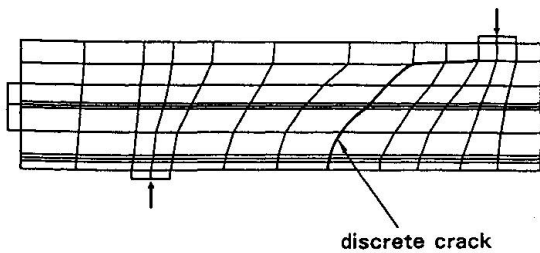

Fig.1 Specimen



(a) Observed and analyzed cracks



(b) Meshing and discrete crack

Fig.2 Observed and modeled cracks

2. OUTLINE OF FEM ANALYSIS

The program used for the FEM analysis was "COMM2"<sup>1)</sup> in which Maekawa model is applied for concrete element. The bond link elements which are available in COMM2 were used for force transfer along shear crack and for bond force between concrete and steel. The force transferred along shear crack was calculated by Li & Maekawa model<sup>2)</sup> for the case that slip occurred ( $\delta > 0.001\text{mm}$ ), and Reinhardt et al's model<sup>3)</sup> was used for the case of no slip ( $\delta < 0.001\text{mm}$ ). The model for the bond force was Shima et al's model<sup>4)</sup>. The main shear crack was modeled as a discrete crack whose location and configuration were determined according to the observed shear crack in the previous study<sup>5)</sup>. The details of nine specimens<sup>5)</sup> which were analysed are shown in Fig.1 and Table 1. An example of observed cracking pattern and the corresponding meshing pattern were given in Fig.2. All the concrete elements adjacent to the discrete crack were assumed not to crack, while the other concrete elements were ordinary one in which crack was modeled as smeared crack. The prestressing force was applied by imposing the force at a node of a steel element for the anchor plate in the actual beam<sup>5)</sup>. The magnitude of the imposed force was equal to the observed effective prestressing force<sup>5)</sup>.

3. ANALYTICAL RESULTS

3.1 Effect of Prestressing Force on Shear Strength



Specimen (1)	$f_c'$ MPa (2)	$P_{eff}$ kN (3)	$X_1$ mm (4)	$X_2$ mm (5)	$X_3$ mm (6)	$V_{su,exp}$ kN (7)	$V_{su,FEM}$ kN (8)	$V_{su,cal}$ kN (9)	(7) — (8)	(7) — (9)	$V_{fu,cal}$ kN (10)	$V_{su,cal2}$ kN (11)	$V_{su,cal3}$ kN (12)
A-0	26.6	0	28	55	119	44.1	40.5	40.4	1.08	1.09	75.8	42.7	28.1
A-1	24.6	48	43	85	136	51.5	53.9	54.7	0.96	0.94	76.5	59.1	42.5
A-2	26.6	112	57	90	145	59.3	54.1	61.9	1.10	0.96	84.8	62.8	52.3
A-3	24.6	152	66	115	162	72.6	62.6	69.6	1.14	1.04	83.7	76.8	65.1
A-4	36.5	99	62	65	102	63.3	63.2	64.4	1.00	0.98	83.3	75.6	57.8
A-5	36.5	0	34	55	86	46.6	63.5	55.5	0.73	0.84	77.7	64.3	38.5
B-1	57.5	148	38	55	84	89.2	101.4	87.5	0.88	1.02	118.6	110.1	77.9
B-2	57.5	41	-	40	83	67.7	70.9	65.4	0.96	1.03	117.7	73.9	42.2
B-3	57.5	152	37	60	83	78.5	79.3	94.6	0.99	0.83	102.5	96.3	70.1

- Note (2) Cylinder strength at test  
 (3) Effective prestressing force  
 (4) Observed depth to shear crack at loading point  
 (5) Calculated depth to neutral axis at maximum moment region when flexural failure  
 (6) Depth to neutral axis obtained by FEM at maximum moment region when shear failure  
 (7) Measured ultimate shear strength  
 (8) Ultimate shear strength obtained by FEM  
 (9) Calculated ultimate shear strength using  $x_2$   
 (10) Calculated ultimate flexural strength  
 (11) Shear strength calculated by the method in the previous study<sup>6)</sup>  
 (12) Shear strength calculated by the method in the previous study<sup>7)</sup>

Table 1 Shear strengths

Comparing the analytical strengths,  $V_{su,FEM}$  with the experimental strengths,  $V_{su,exp}$ , shown in Table 1 and Fig.3, it can be said that the shear strengths of all the specimens are predicted well by the FEM except specimen A-5. It was found in the FEM analysis that the ultimate shear strengths were controlled by compression failure ( strain softening ) of concrete element in compression zone of the maximum moment region. Although the concrete compression failure looked the same as in flexural failure of the beams, the ultimate strengths are much less than the calculated flexural strengths as shown in Table 1. The reason for this fact can be found in concrete strain distribution at a cross-section in the maximum moment region. As shown in Table 1 and Fig.4, depths to the neutral axis,  $x_2$ , obtained from the concrete strain distribution calculated by the FEM, are much less than depths,  $x_3$ , calculated by a conventional method for ultimate flexural strength using an equivalent stress block. This narrow compression zone leads

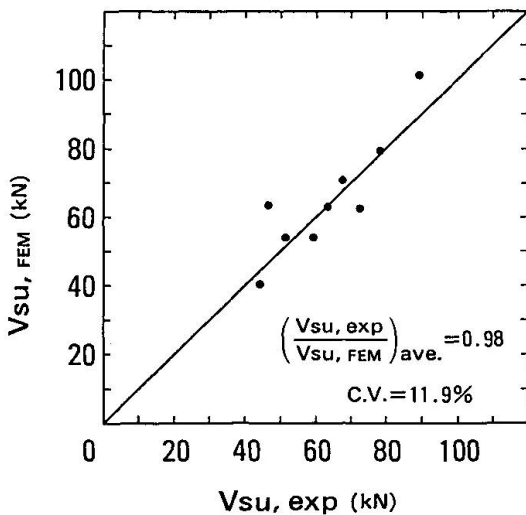

Fig.3 Test and FEM predictions

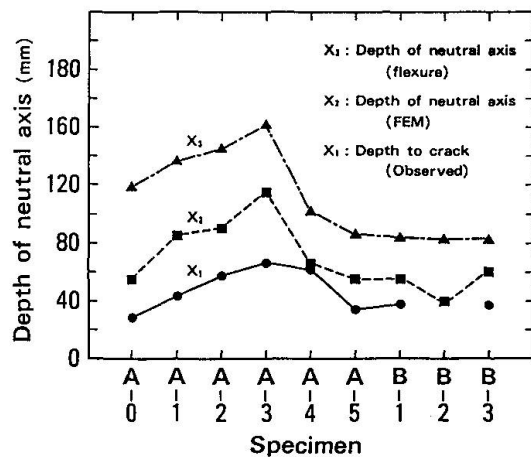

Fig.4 Depths of compression zone



earlier concrete failure in compression zone, which means that the shear strength is less than the flexural strength. It is also seen in Fig.4 and Table 1 the depth to the neutral axis at shear compression failure is significantly greater than the depth to shear crack,  $x_1$ . Shear cracks penetrated in the compression zone.

The FEM analysis predicts adequately increase in the shear strength with increase of prestressing force as observed in the experiment<sup>5)</sup>. Table 1 and Fig.4 indicate that among specimens A-0 to A-3 the computed depth of compression zone,  $x_2$ , increases with increase of prestressing force. This increase of compression zone depth causes increase of the shear strength.

An observed depth to shear crack tip,  $x_1$ , was greater in a beam with a greater prestressing force. Location of shear cracking in compression zone varies as prestressing force varies. In order to see the effect of depth to shear crack tip on the shear strength, the shear strengths were calculated by the FEM for two cases of the depths, 20mm and 70mm. The calculated strengths, however, were not so different. It seems that the difference in the depth to shear crack tip hardly causes the difference in the shear strength.

The FEM analysis indicates that the depth of compression zone just outside the maximum moment region is greater than that in the maximum moment region. Therefore, despite combination of flexural moment and shear force, the principal compressive stress is much less than that in the maximum moment region. This is considered to be the reason why the failure of concrete did not occur outside the maximum moment region. The concrete compression failure in compression zone of the maximum moment region is failure criterion for the case of shear compression failure of a beam. To calculate the shear strength, therefore, the depth to the neutral axis should be evaluated by some means. The shear strengths,  $V_{su,cal}$ , in Table 1 and Fig.5 were calculated by a conventional method for ultimate flexural strength with an equivalent stress block and neutral axis depth given by the FEM analysis. Similar ways for calculation of the shear strength were proposed by the previous studies<sup>6) 7)</sup>. Although simplified assumptions were adopted, the predicted shear strengths,  $V_{su,cal}$ , have a good agreement with the experimental ones,  $V_{su,exp}$ , as shown in Fig.5 and Table 1, while the values predicted by the previous studies<sup>6) 7)</sup> have less agreements. Figure 5

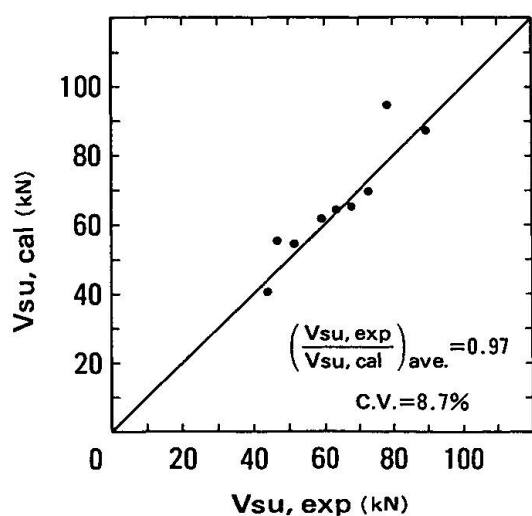

### 3.2 Effect of Force Transferred along Shear Crack

The force transfer model along a discrete shear crack was varied to see its effect on the shear strength. There were four cases in which the stiffness of the model was varied in such a way that it was 100%, 10%, 1% or 0% of the original model's stiffness. The shear strengths for the four cases were 100%, 91%, 89% and 23% of that with the original model. With 0% of the stiffness the shear strength was greatly

Fig.5 Test and simplified predictions

reduced, but with 1% of the stiffness reduction in the strength was only 11%. Length of the shear crack in the analysis was shorter than the observed one for every case. For another case, 0% of the stiffness was implemented only along the shear cracked part in the case of 100% stiffness, while in the vicinity of tip of the discrete shear crack 100% of the stiffness was implemented. In this case the shear strength was 95% of that with 100% of the stiffness at all the part of the discrete shear crack.

From the FEM analysis it was observed that slip ( $\delta > 0.001\text{mm}$ ) takes place at most of the part along the shear crack. In the analysis, therefore, Li & Maekawa's model was used for most of the part along the shear crack. Considering this fact, Reinhardt's model was assumed under any amount of slip to see the effect of type of force transfer model on the shear strength. The predicted shear strength in this case was 97% of that of the original case.

From comparison of the predicted shear strengths of the beams with a various force transfer model along the discrete shear crack, it can be said that effect of the force transferred along a main shear crack on the shear strength is negligibly small. Only the force transferred near the tip of the shear crack which is close to the loading point and in the compression zone affects the shear strength. Estimated transferred stresses along the shear crack were considerably smaller than the stresses in concrete near the shear crack. This fact seems to support the little effect of the force transfer model on the shear strength.

### 3.3 Effect of Crack Model Type

In this study type of shear failure is "shear compression failure", for which shear cracking does not mean ultimate state. In this sense tensile strength of concrete has less significant than in shear tension failure. Furthermore, model for post-cracking is rather little significant for the ultimate shear strength as discussed in the previous subsection. It was found, however, that whether discrete crack or smeared crack was assumed for a main shear crack did affect the shear strength of the beam. In the original FEM analysis a discrete crack was assumed, and concrete elements next the discrete crack were assumed to be non-cracking elements. In another case smeared cracking was assumed for all the concrete elements. The predicted strength in this case was 78% of the original case. It seemed that more cracking elements in compression zone at the maximum moment region caused early failure.

## 4. CONCLUSIONS

- (1) The FEM analysis, in which concrete is modeled as nonlinear material subjected to bi-axial stress state and a main shear crack is modeled as a discrete crack, can predict the strengths for shear compression failure in reinforced concrete beams subjected to axial force.
- (2) Shear compression failure is caused by compression failure of concrete in compression zone at the maximum moment region. The depth of the compression zone is less than that in flexural failure, so that the shear strength is less than the flexural strength.
- (3) Using the depth of compression zone obtained by the FEM analysis, the strength for shear compression failure can be estimated by the conventional method of flexural strength.
- (4) Cracking and post-cracking models, which is force transfer model along the



discrete shear crack, affect little the predicted shear strength. Whether discrete crack or smeared crack is assumed for the main shear crack, however, influences the prediction of the shear strength.

#### ACKNOWLEDGEMENT

This study was supported in part by Saito Memorial Research Foundation of Prestressed Concrete Technology.

#### REFERENCES

1. MAEKAWA K., NIWA J. and OKAMURA H., Computer Program "COMM2" for Analysing Reinforced Concrete. Proceedings of JCI 2nd Colloquium on Shear Analysis of RC Structures, October 1982, pp.79-86 ( in Japanese ).
2. LI B., MAEKAWA K. and OKAMURA H., Contact Density Model for Stress Transfer across Cracks in Concrete. Journal of the Faculty of Engineering, the University of Tokyo(B), Vol.XL, No.1, March 1989, pp.9-52.
3. REINHARDT H., CORNELISSEN H. A. W. and HORDIJK D. A., Tensile Tests and Failure Analysis of Concrete, Journal of Structural Engineering, ASCE, Vol.112, 1986, pp.2462-2477.
4. SHIMA H., CHOU L. L. and OKAMURA H., Micro and Macro Models for Bond in Reinforced Concrete. Journal of the Faculty of Engineering, the University of Tokyo(B), Vol.XXXIX, No.2, September 1987, pp.133-194.
5. HORIBE K. and UEDA T., Influence of Axial Force on Shear Behavior of Reinforced Concrete Beams. Proceedings of 40th Annual Convention of JSCE, Div.5, September 1985, pp.319-320 ( in Japanese ).
6. ZOWYER E. M., Shear Strength of Simply-Supported Prestressed Concrete Beams. Structural Research Series No.53, Civil Engineering Studies, University of Illinois, Urbana, Illinois, June 1953.
7. EVANS R. H. and SCHMACHER E. G., Shear Strength of Prestressed Beams Without Web Reinforcement. Journal of ACI, Vol.60, November 1963, pp.1621-1643.