

# Stresses and strains in a model ring under internal radial pressure

Autor(en): **Bilik, Juraj / Priechodský, Vladimír**

Objekttyp: **Article**

Zeitschrift: **IABSE reports = Rapports AIPC = IVBH Berichte**

Band (Jahr): **62 (1991)**

PDF erstellt am: **23.07.2024**

Persistenter Link: <https://doi.org/10.5169/seals-47714>

## **Nutzungsbedingungen**

Die ETH-Bibliothek ist Anbieterin der digitalisierten Zeitschriften. Sie besitzt keine Urheberrechte an den Inhalten der Zeitschriften. Die Rechte liegen in der Regel bei den Herausgebern.

Die auf der Plattform e-periodica veröffentlichten Dokumente stehen für nicht-kommerzielle Zwecke in Lehre und Forschung sowie für die private Nutzung frei zur Verfügung. Einzelne Dateien oder Ausdrucke aus diesem Angebot können zusammen mit diesen Nutzungsbedingungen und den korrekten Herkunftsbezeichnungen weitergegeben werden.

Das Veröffentlichen von Bildern in Print- und Online-Publikationen ist nur mit vorheriger Genehmigung der Rechteinhaber erlaubt. Die systematische Speicherung von Teilen des elektronischen Angebots auf anderen Servern bedarf ebenfalls des schriftlichen Einverständnisses der Rechteinhaber.

## **Haftungsausschluss**

Alle Angaben erfolgen ohne Gewähr für Vollständigkeit oder Richtigkeit. Es wird keine Haftung übernommen für Schäden durch die Verwendung von Informationen aus diesem Online-Angebot oder durch das Fehlen von Informationen. Dies gilt auch für Inhalte Dritter, die über dieses Angebot zugänglich sind.

## Stresses and Strains in a Model Ring under Internal Radial Pressure

Contraintes et déformations dans un anneau soumis  
à une pression radiale intérieure

Spannungen und Verformungen im Betonring-Modell unter Radialdruck

### Juraj BILČÍK

Civil Eng.  
Techn. Univ.  
Bratislava, Czechoslovakia

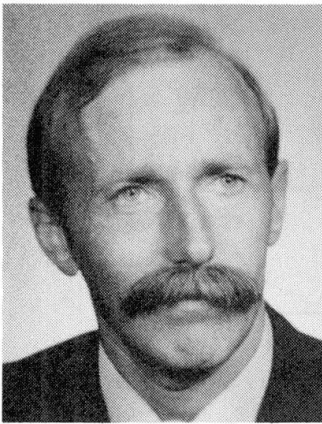

Juraj Bilčík, born 1947, obtained his civil engineering degree at the Slovak Technical University Bratislava, where, he is currently working as a reader at the Department of Concrete Construction and Bridges.

### Vladimír PRIECHODSKÝ

Civil Eng.  
Techn. Univ.  
Bratislava, Czechoslovakia

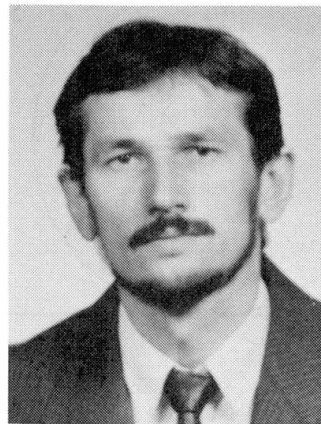

Vladimír Preichodský, born 1953, obtained his civil engineering degree at the Slovak Technical University Bratislava, where, he is currently working as a researcher at the Department of Concrete Construction and Bridges.

### SUMMARY

A thick-walled concrete ring model is presented to analyze the state of stresses in the anchored zone of ordinary reinforcement and prestressing steel. The stress-strain diagram of concrete with an ascending and descending branch was used to describe the measured, large, relative strains. A gradual plastification starting from the internal surface of the ring towards the external one was observed.

### RÉSUMÉ

Un modèle d'anneau en béton à parois épaisses est étudié en vue d'analyser l'état de contrainte régnant dans la zone d'ancrage d'armatures ordinaires et des aciers de précontrainte. Le diagramme contrainte-déformation du béton présentant une branche croissante et décroissante a été pris en compte lors de la description des déformations relatives élevées obtenues. Les résultats montrèrent une plastification progressive s'étendant de la face intérieure de l'anneau jusqu'à sa face extérieure.

### ZUSAMMENFASSUNG

Es wird ein dickwandiges Betonring-Modell vorgestellt und zur Analyse der Spannungen im Eintragungsbereich der Bewehrungsstäbe und Spanndrahtlitzen herangezogen. Für die Beschreibung der gemessenen grossen örtlichen Dehnungen wird ein Kraft-Verformungs-Diagramm mit einem steigenden und einem fallenden Ast benützt. Es wurde eine kontinuierliche Plastifizierung des Querschnitts vom inneren zum äusseren Rand des Betonrings festgestellt.



## 1. INTRODUCTION

Anchorage of deformed bars and strands by bond causes relatively large radial compressive stresses at the interface between steel and concrete. A thick-walled concrete ring model has been considered to analyse the influence of radial compressive stress on the state of tensile stresses in the anchored area. The concrete ring approximates the effect of the surrounding concrete. The cylinder can be located in the beam section as shown in Fig.1.

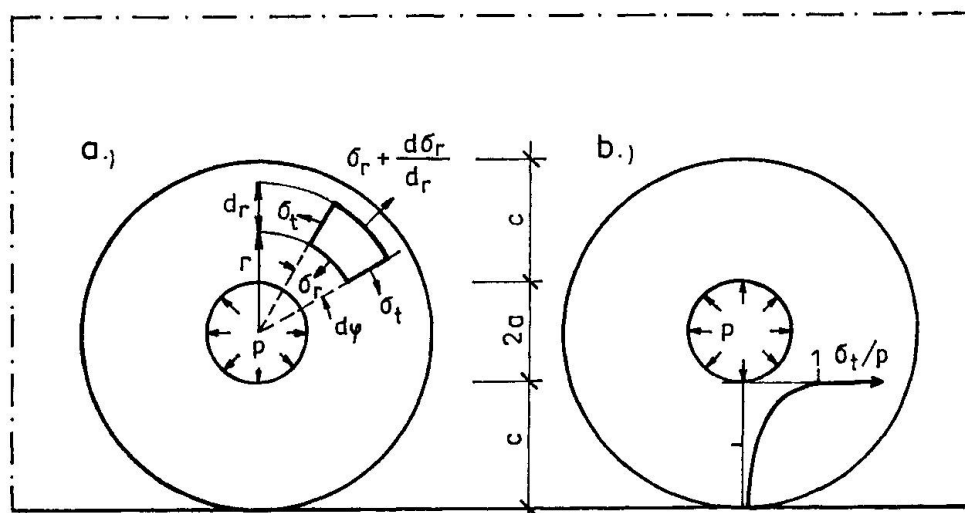

Fig. 1: a/ Location and geometry of the ring model in the section and stresses on an element.  
b/ The variation in tangential tensile stresses in the ring model at the elastic stage.

The stresses are mostly calculated for an elastic or plastic stage:

- a solution for the stresses in a thick-walled ring subjected to internal pressure at the elastic stage is given by Timoshenko [1],
- the concrete is assumed to act plastically, that is the ring will not break until the stresses in the tangential direction at every part of the ring section have reached the ultimate tensile concrete stress [2].

## 2. EXPERIMENTAL TESTS FOR EVALUATION OF STRAINS

The variation in tangential and radial strains were investigated on thick-walled concrete rings with inner radius  $a = 9$  mm, outer radius  $b = 50, 100, 150$  mm and a height of 30 mm. The test rings concrete mix was of the following properties:

- the aggregate was a washed river sand with a maximum size of 4 mm,
- compressive cube strength  $f_c = 37,9 \text{ N.mm}^{-2}$ ,
- tensile strength  $f_t = 2,8 \text{ N.mm}^{-2}$ ,
- modulus of elasticity  $E = 28\,125 \text{ N.mm}^{-2}$  and Poissons ratio  $\nu = 0,134$  at stress level of about 40 % of ultimate strength.

The rings were subjected to hydraulic pressure on the inner surface. The deformations of the rings were monitored with electric resistance strain gauges (length 8 mm) in the radial and tangential direction - see Fig. 2. The observed relative tangential strains  $\epsilon_t$  and relative radial strains  $\epsilon_r$  in the ring model for the increasing internal radial pressure  $p_i^r$  are plotted in the Fig. 2. In order to show the ability of the model to carry large strains it was important to measure also the strains in the fracture zone, i. e. where the final failure occurs due to a crack.

### 3. TEST RESULTS AND DISCUSSION

Fig. 2 shows that the tangential strains measured in the fracture zone are much higher (Fig. 2b) than that observed outside this zone (Fig. 2c, d, e).

Before the ring fails due to a crack in the fracture zone, under increasing radial pressure, a strain decrease was registered outside the fracture zone. The following general conclusions regarding the experimental tests may be drawn:

1. The measured tangential strains in the fracture zone reached the maximal value  $\epsilon_t = 2,4 \cdot 10^{-3}$  which many times exceeds the ultimate strain recorded at the centric tension test  $\epsilon_t = 0,12 \cdot 10^{-3}$ .
2. The test indicate that the observed maximum carrying capacity of the rings, exposed to internal radial pressure are lower than the theoretically carrying capacity at the plastic stage. These informations indicate that the intensity of tangential stress is considerably lower if the strain in the fracture zone exceeds a certain critical value. This fact shows that the fictitious crack model [3] gives a realistic description of tensile stresses in the tested rings. Based on the fictitious crack model it was possible to describe the state of tensile stresses in the ring.

The ascending branch of the stress-strain diagram was determined by means of the tensile test. The descending branch have been determined from the strains measured just before the final failure occurs and from the observed carrying capacity of the rings.

The carrying capacity is given by

$$\int_a^b \sigma dr = p \cdot a \quad (1)$$

The stress-strain diagrams of concrete for various inner radius are shown in Fig. 3.

Fig. 4 shows the variation in the tangential tensile stresses according to the stress-strain diagrams in Fig. 3.

It can be seen a continual transmission from elastic to elastoplastic stage starting from the internal surface of the ring towards the external one. From the distribution of the stresses it is evident that it is not possible to consider the ultimate tensile strength evenly distributed over the cross section.

The measured load capacities of the tested concrete rings, at the time cracks first appear, are plotted in Fig. 5. The experimental values occur just where expected, i. e. between the elastic and plastic stages.

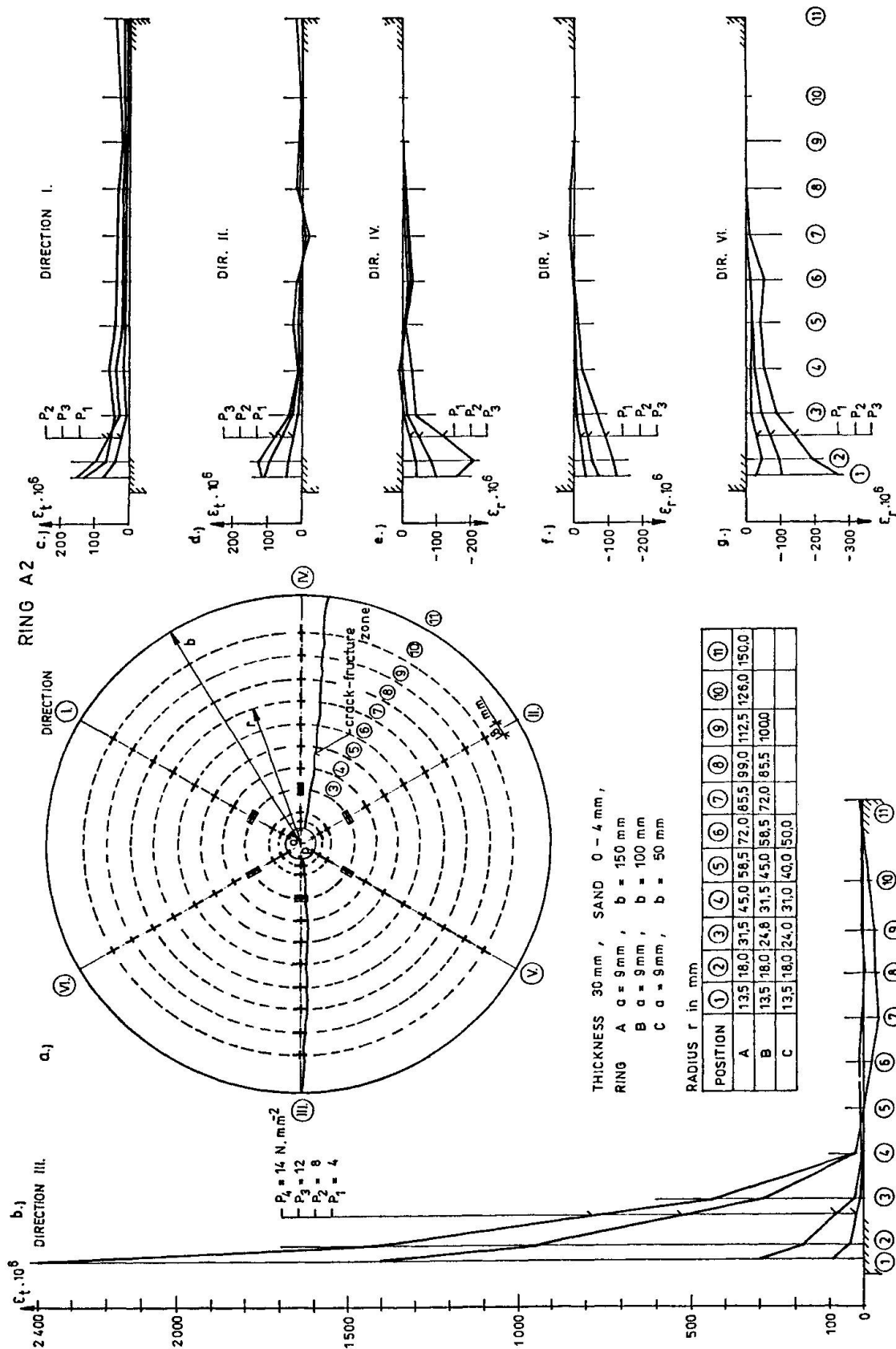

Fig. 2: The variation in the relative strains  $\epsilon_t$  and  $\epsilon_r$  in the ring model

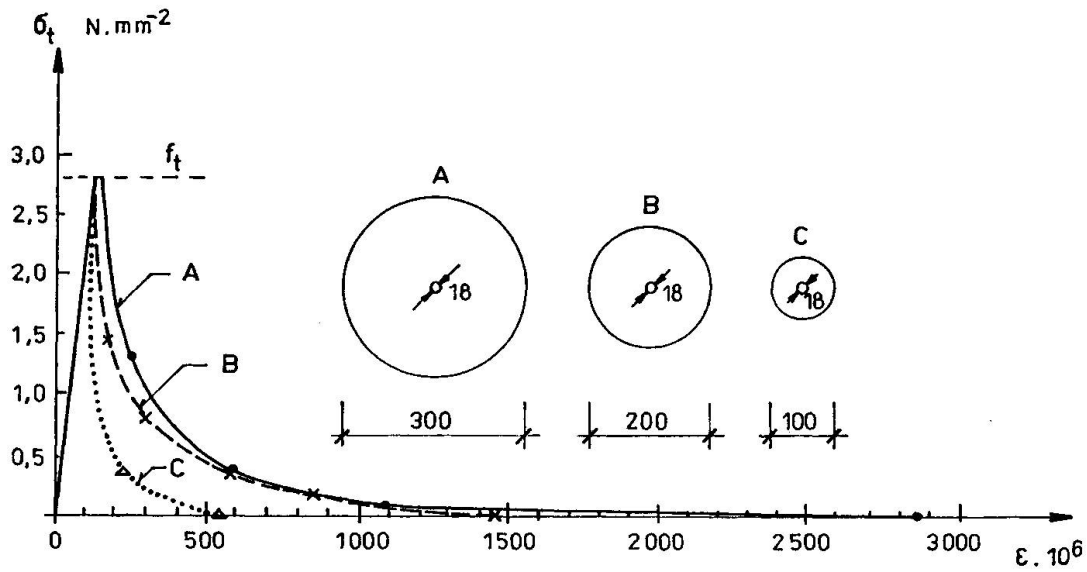

Fig. 3: Stress-strain diagrams of concrete in tension

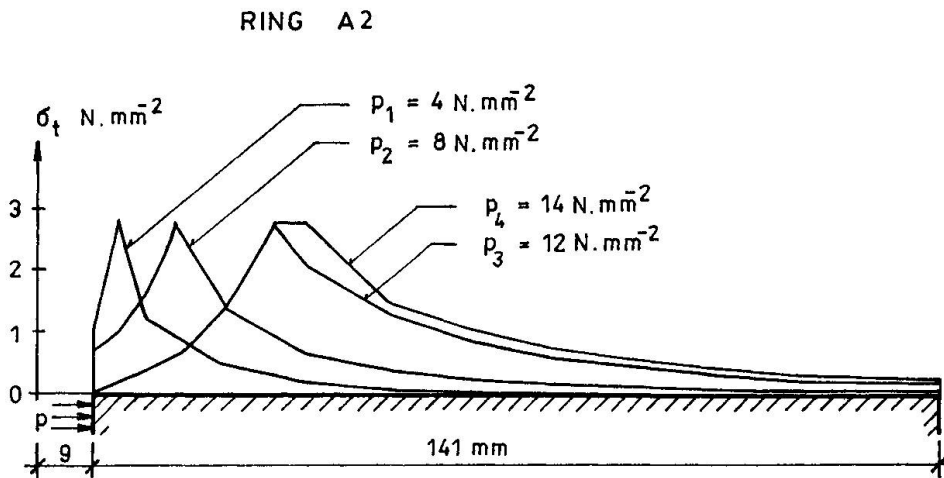

Fig. 4: The variation in the tangential tensile stresses for the increasing internal pressure

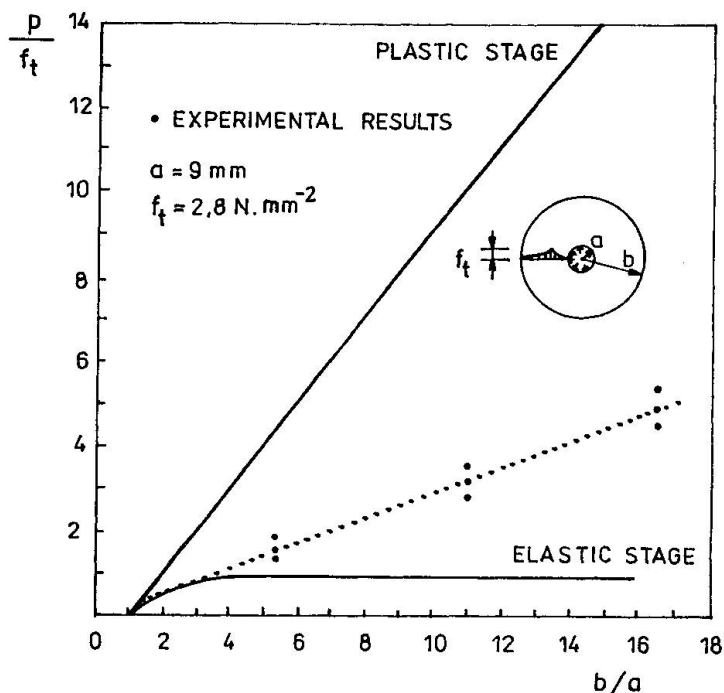

Fig. 5: Load carrying capacities of the rings on occurrence of cracking.

#### 4. CONCLUSIONS

Realized tests confirm that by means of the elastoplastic ring model, based on the stress-strain diagram with an ascending and descending branch, it is possible to analyse the state of the tensile stresses in the transmission zone of prestressed or non-prestressed reinforcement. Further tests based on the same approach are recommended in order to obtain valid results for practical design purposes.

#### REFERENCES

1. TIMOSHENKO S., Strength of materials Part II: Advanced theory and problems. Princeton, N.J., D van Nostrand Company Inc. 1956. pp. 205-210.
2. TEPFERS R., A theory of bond applied to overlapped tensile reinforcement splices for deformed bars. Gothenburg, Chalmers University of Technology, Division of Concrete Structures, 1973, Publication 73:2.
3. HILLERBORG A., Reliance upon concrete tensile strength. IABSE Colloquium "Structural concrete", Stuttgart, April 1991.
4. KÖNIG G., DUDA H., Basic Concept for Using Concrete Tensile Strength, *ibid*.
5. KÖNIG G., SCHEIDLER D., FEHLING E., Grundlagen zur Traglastermittlung unbewehrter Betonbauteile unter Zugbeanspruchung, Beton und Stahlbetonbau, November 1986. pp. 292-296, December