

# Consistent design and new systems for concrete bridges

Autor(en): **Menn, Christian**

Objektyp: **Article**

Zeitschrift: **IABSE reports = Rapports AIPC = IVBH Berichte**

Band (Jahr): **62 (1991)**

PDF erstellt am: **23.07.2024**

Persistenter Link: <https://doi.org/10.5169/seals-47725>

## **Nutzungsbedingungen**

Die ETH-Bibliothek ist Anbieterin der digitalisierten Zeitschriften. Sie besitzt keine Urheberrechte an den Inhalten der Zeitschriften. Die Rechte liegen in der Regel bei den Herausgebern. Die auf der Plattform e-periodica veröffentlichten Dokumente stehen für nicht-kommerzielle Zwecke in Lehre und Forschung sowie für die private Nutzung frei zur Verfügung. Einzelne Dateien oder Ausdrucke aus diesem Angebot können zusammen mit diesen Nutzungsbedingungen und den korrekten Herkunftsbezeichnungen weitergegeben werden. Das Veröffentlichen von Bildern in Print- und Online-Publikationen ist nur mit vorheriger Genehmigung der Rechteinhaber erlaubt. Die systematische Speicherung von Teilen des elektronischen Angebots auf anderen Servern bedarf ebenfalls des schriftlichen Einverständnisses der Rechteinhaber.

## **Haftungsausschluss**

Alle Angaben erfolgen ohne Gewähr für Vollständigkeit oder Richtigkeit. Es wird keine Haftung übernommen für Schäden durch die Verwendung von Informationen aus diesem Online-Angebot oder durch das Fehlen von Informationen. Dies gilt auch für Inhalte Dritter, die über dieses Angebot zugänglich sind.

## Consistent Design and New Systems for Concrete Bridges

Systèmes traditionnels et innovatifs pour des ponts en béton

Traditionelle und neuartige Tragsysteme für Betonbrücken

### Christian MENN

Dr. sc. techn.  
Swiss Fed. Inst. of Technology  
Zurich, Switzerland

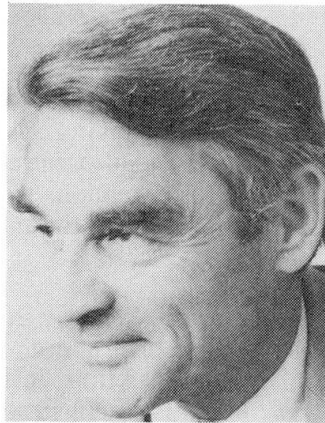

Christian Menn was in private practice from 1957 to 1971. During this time, he was primarily active in bridge design. Since then, he has been Professor of Structural Engineering at the Swiss Federal Institute of Technology (ETH) in Zurich and has been active as consultant on many large bridge projects.

### SUMMARY

The arrangement of reinforcement and dimensioning of prestressing steel have a major influence on quality and economy of concrete structures. This paper outlines criteria for traditional and new structural systems that are of fundamental importance in this regard.

### RÉSUMÉ

La disposition des acier d'armature et le dimensionnement de l'acier de précontrainte ont une influence majeure sur la qualité et l'économie des constructions en béton. Le present exposé présente des critères importants à cet égard pour des ouvrages traditionnels et innovatifs.

### ZUSAMMENFASSUNG

Die Anordnung der Bewehrung und die Bemessung der Vorspannung haben einen entscheidenden Einfluss auf die Qualität und die Wirtschaftlichkeit von Betontragwerken. Im vorliegenden Beitrag wird aufgezeigt, welche Kriterien diesbezüglich bei traditionellen und neuartigen Tragsystemen grundsätzlich zu beachten sind.



## 1. RETROSPECTIVE LOOK

### 1.1 Introduction of Prestressed Concrete

By the late 1930s, a relatively high state of development had already been achieved in reinforced concrete construction. Girder bridges had been built with spans of nearly 70 m. The absence of a satisfactory means of controlling cracking and deflections, however, would prevent the construction of greater spans. Arch bridges, on the other hand, had been constructed with spans of over 100 m. Spans of arches were limited only by economy and technical problems in the construction of falsework. The introduction of prestressed concrete after World War II made possible a much wider range of spans for girder bridges.

Prestressed concrete originally consisted of two different concepts: (1) prestressing with steel bonded to concrete, developed in France, and (2) prestressing with external, unbonded steel, developed in Germany. The unsatisfactory behaviour of early externally prestressed bridges led to the dominance of the French concept of bonded prestressing in pre-tensioned and post-tensioned construction. As a result, prestressing wires or tendons were almost without exception located within the concrete section. A rapid development of optimal cross-section types for prestressed girder bridges took place soon after World War II.

In the 1950s and 1960s, developments occurred mainly in construction technology, including cast-in-place cantilever construction, span-by-span construction, incremental launching, precast girders with cast-in-place deck slab, cast-in-place construction on launching girders, and precast segmental cantilever construction. These new methods of construction resulted in cost savings much greater than improvements in design methods or higher material strengths. They enabled costs for falsework and formwork, which account for roughly 25 percent of total construction cost, to be reduced by approximately one third.

### 1.2 Fundamentals of Dimensioning

Freyssinet understood prestressed concrete as a fundamentally new method of construction, in which tensile stresses in concrete were completely prevented. Through this concept, known as *full prestressing*, he decisively influenced the dimensioning of prestressed concrete. It was thus common in the 1950s to dimension prestressed concrete girders to prevent tensile stresses at the extreme fibres of the cross-section. Experience with continuous T-girders and skew slab bridges soon revealed that full prestressing required a disproportionately high consumption of prestressing steel. As a consequence, *limited prestressing*, by which restricted tensile stresses were permitted, was soon introduced in several design standards.

Checks of safety at ultimate limit state, already common in the 1950s, revealed that the actual factor of safety of structures with full or limited prestressing is usually much higher than the values specified in standards. This led to the development of *partial prestressing*, by which the entire reinforcement, mild and prestressed, was dimensioned on the basis of safety at ultimate limit state. Partial prestressing resulted in additional economy and a unified concept of safety for reinforced and prestressed concrete.

The cost savings resulting from partial as opposed to full prestressing normally amount to only 1.5 percent of total construction cost. More important is the unified philosophy of safety for reinforced concrete and prestressed concrete that results from partial prestressing, which opens the entire range between classical reinforced concrete and fully prestressed concrete. This enables engineers to choose freely the area of prestressing steel based on criteria relating to quality, economy, and good detailing practise.

### 1.3 Experiences

Experience obtained from the vast number of prestressed concrete structures built thus far has proven that prestressed concrete has no fundamental deficiencies. Defects occur only due to problems with

materials, lack of care in design, detailing, and construction, or insufficient protection against unforeseen actions. (Deicing chemicals, for example, were not used in Switzerland prior to the 1960s. The reinforcement of many bridges designed before this time is inadequately protected against corrosion according to current standards.)

Experience has also shown that tensile stresses can occur in all types of structures, even fully prestressed, due to self-equilibrating states of stress. Such states of stress, which are difficult to quantify, can lead to the formation of cracks. Fortunately, these cracks are harmless provided sufficient mild reinforcement is provided to distribute them and to limit their width. Partially prestressed structures with sufficient mild reinforcement thus normally have better cracking behaviour as compared to fully prestressed structures with insufficient mild reinforcement.

## 2. NEW DESIGN CONCEPTS

### 2.1 Safety and Serviceability

Most new design concepts prescribe checks of safety and serviceability.

The check of safety normally serves as the basis of dimensioning. Forces and stresses due to actions, increased by appropriate load factors, are compared to structural resistance, decreased by a resistance factor. This simple convention has proven itself and is now firmly established. It nevertheless neglects many sources of risk, which are just as important as the statistical dispersion of actions and material strength and which must be considered in any comprehensive approach. These include, for example, changes in actions that occur over time and loss of structural capacity. The margin of safety must also account for small deficiencies in analysis, design, and detailing. Margins of safety should, moreover, be varied according to risk, economic importance, probability of unforeseen actions, and service life of structures. Engineers should be aware of these additional sources of risk and should not be tempted to make drastic reductions in factors when loads and resistances can be measured exactly (e.g. in existing structures). This way leaves little or no margin of safety for the previously mentioned additional risks.

The check of serviceability ensures durability, proper functioning, and undamaged appearance of structures. All requirements specific to the structure with regard to actions, structural system, and use should be compiled. The combination of material technology, detailing, and design that satisfies these requirements must then be selected.

### 2.2 Significance and Purpose of Prestressing

Prestressing technology enables the use of high-strength steel in concrete. This results in significant economic advantages, both direct (use of steel with high ratio of tensile strength to cost) and indirect (concrete sections are lighter and more slender).

An additional and even more important advantage of prestressing is its favourable effect on deformations and cracking. The prestressing force can be chosen according to economic criteria and performance requirements specific to the structure. (This is especially true for partially prestressed structures.) Deformations due to dead load can be compensated fully or to whatever extent is desirable and the cracking load (i.e., the load corresponding to the first formation of cracks) can be significantly increased. Sufficient mild reinforcement must be provided to distribute and limit the width of cracks resulting from restrained deformations. The quantity of mild reinforcement is normally independent of the magnitude of the cracking load. In addition, the cracking sectional force should be distributed over an extensive area when the cracking load is reached, to ensure cracks are well distributed. Sharp peaks in the cracking sectional force diagram (e.g. when prestressing tendons are coupled at construction joints) must be more strongly reinforced or avoided altogether.



### 3. FUNDAMENTALS OF ANALYSIS, DIMENSIONING, AND DETAILING

#### 3.1 Design Procedure

In Switzerland, the design of bridges is normally divided into the following three phases:

1. Preliminary design
2. General design (for tender)
3. Final design (for construction)

In the preliminary design phase, several alternate systems are drawn at small scale and are checked or dimensioned as required with rough, simplified calculations. Reinforcement can be determined in this way to within 10 or 20 percent. It is essential that all critical cross-sections and details be worked out and drawn at large scale in this phase. Neglecting this important component of preliminary design can lead to compromises on details during later phases of design. This ultimately results in difficulties in construction and often in damage to the structure (fig. 1).

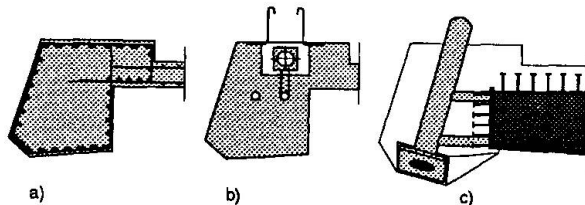

*Fig. 1 Example of uncoordinated (unbuildable) detailing in general design: (a) Arrangement of mild reinforcement without consideration of splices; (b) Prestressing tendon; (c) Anchorage of stay cable*

In the general design phase, analyses of greater precision are carried out to finalize cross-section dimensions and to determine reinforcement to within 5 percent. Simplified statical models are normally sufficient, however, even at this phase. All structural details, including splices of reinforcement, anchorage of tendons, and accessories (utility ducts, drainage, etc.) should be checked for constructability and finalized.

In the final design phase, the structural system and its components are checked using "exact" methods of analysis based on models that closely match actual conditions. Dimensions of cross-sections should not require modification at this stage. Provided details have been checked during the preliminary phase and finalized during the general phase, the constructability of the final design will be ensured and the prerequisites for high structural quality will have been satisfied.

#### 3.2 Arrangement of Reinforcement

Reinforced concrete is a composite material in which tensile forces are resisted by steel reinforcement in practically all cases. The tensile strength of concrete may only be considered to a limited extent, and only when tensile stresses due to restrained deformations cannot occur.

The state of equilibrium of internal tension and compression elements is just as important as the external state of equilibrium of the entire system. The latter, however, normally receives much more analytical effort than the former. The effectiveness of reinforcement dimensioned on the basis of equilibrium of the entire system must be carefully checked using the state of equilibrium formed by the flow of internal forces.

The internal state of equilibrium can be easily and simply determined using truss models. These should correspond to some degree to the flow of forces in a homogeneous medium. The following points must be observed:

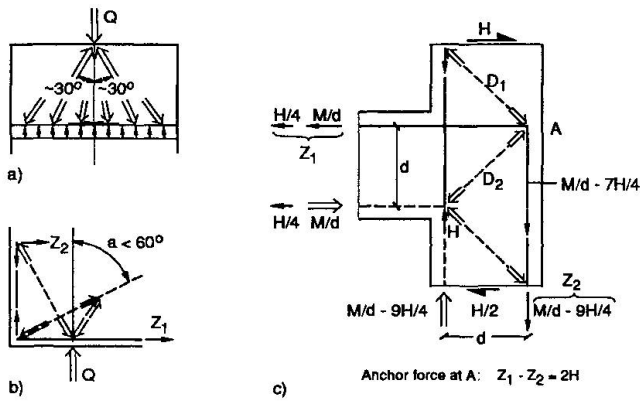

1. The angle at which concentrated forces spread out should be roughly 30 degrees on either side of the line of action of the force (fig. 2a)
2. The angle of deviation of force varies according to the presence of an active compressive force (e.g. due to prestressing) and the anchorage length of reinforcement. When no active compressive force is present, this angle should not be greater than 60 degrees (fig. 2b)
3. Connections of tension and compression elements should be detailed taking into account the location of anchor forces, local bearing stresses, and the corresponding spreading forces (fig. 2c)

The use of the truss analogy is not limited to the calculation of the flow of forces in corners of frames and other connections of members. It is also valid for forces within members, in particular for determining flexural development of reinforcement and for verification of splices in reinforcement. In box cross-sections, for example, the truss analogy leads to simple and clear calculation of flexural development length, anchorage length, and associated transverse reinforcement (fig. 3).

**Fig. 2** Use of truss analogy to determine state of internal equilibrium

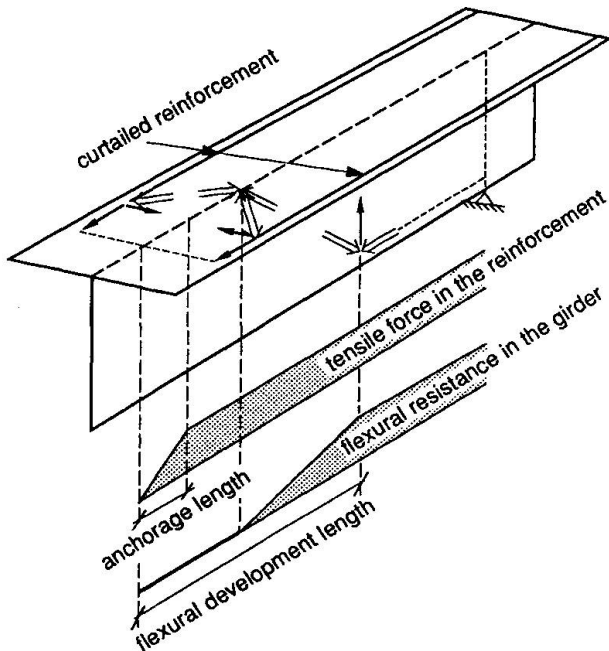
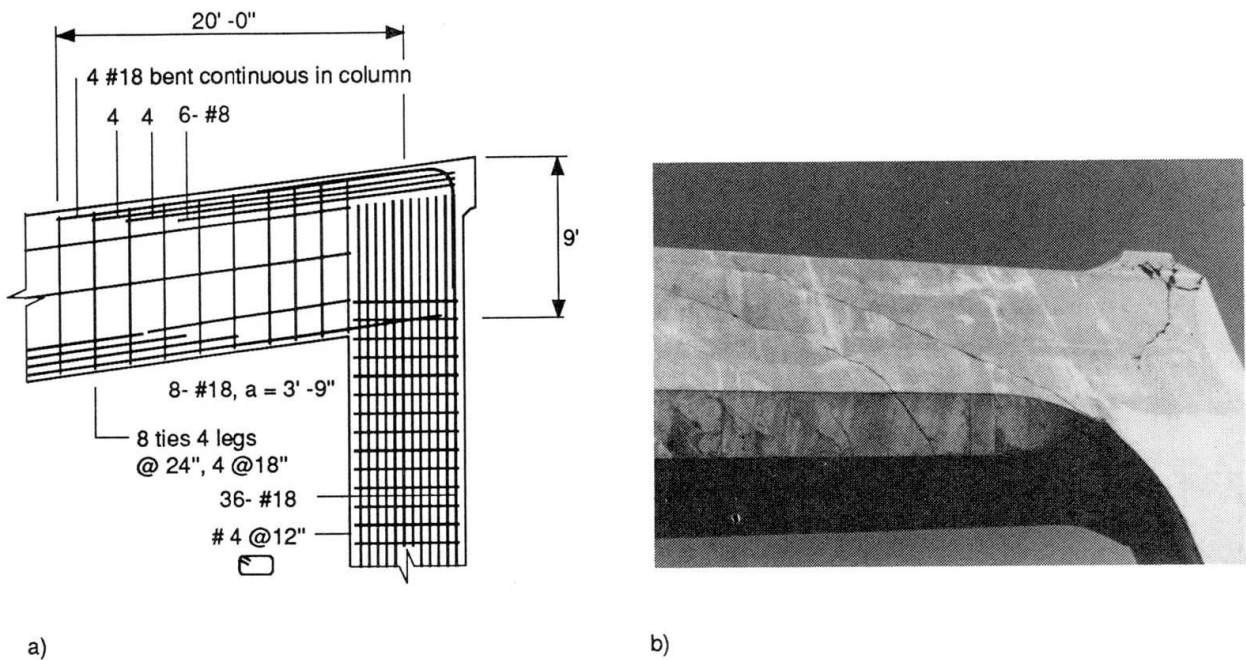

**Fig. 3** Flexural development length

The truss analogy is a reliable tool in design practise for determining the flow of internal forces required for internal equilibrium. Figure 4 shows an example in which flexural development length (internal equilibrium) has not been considered. As a consequence, the flexural resistance of the system is insufficient to withstand the forces required for external equilibrium.

It is unnecessary to use methods of greater precision to minimize reinforcement, since arrangements of reinforcement that are clear, simple, and easy to place lead to better quality and lower construction costs. These factors outweigh any small savings in quantity of steel that may result from greater analytical precision.





**Fig. 4** Frame corner with insufficient flexural development length: (a) Reinforcement; (b) Pattern of cracks

#### 4. NEW DEVELOPMENTS

With the exception of the first externally prestressed concrete bridges in Germany, tendons in girder bridges have almost always been located within the concrete cross-section. Fundamentally new concepts for the arrangement of prestressing appeared only with the construction of cable-stayed bridges, which are essentially none other than cantilevered girders with cables as tension chord and deck girder as compression chord. The stay cables, i.e. the main longitudinal reinforcement, are arranged outside the concrete cross-section and prestressed to produce the desired profile in the roadway. Due to the relative flexibility of the girder, stay cables cannot be prestressed as high as in classical prestressed concrete bridges. The prestressing force in cable-stayed bridges is roughly 30 percent of the yield stress.

In recent years, girder bridges prestressed with unbonded tendons have been built in increasing numbers. External tendons are normally placed inside box girders or between the webs of T-girders. Unbonded prestressing has the advantage that the force and condition of tendons can be continually monitored and, when necessary, tendons can be replaced or strengthened. The use of external tendons in precast segmental girders has the additional advantage of eliminating problems associated with leaking of grout at joints between segments. The disadvantage of unbonded prestressing is that at ultimate limit state, yield stress of the tendons is not always reached. A greater area of prestressing steel is thus required to ensure safety.

It is not necessary and normally not practical to use conventional box or T-cross-sections for externally prestressed bridge girders. These cross-sections, relatively difficult to build, were used with bonded tendons because of the protection they provided for prestressing steel. Their stiffness is generally much larger than required for user comfort with regard to deflections and vibrations, even when partially prestressed.

The following cross-section types can be economical and practical for externally prestressed bridge girders, depending on construction method:

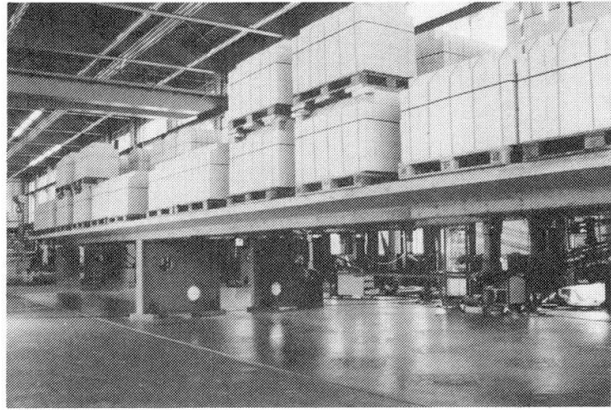

*Fig. 5 Scale model of externally prestressed slab bridge*

(a) *Girder constructed on conventional or mechanized falsework.* External tendons can be arranged beneath the cross-section, resulting in a total structural depth of roughly  $1/15$  of the span. For the concrete girder proper, a depth of only  $1/40$  of the span is necessary. The most appropriate type of cross-section is a compact T-girder with wide webs. Even though deflections and vibrations of such a system may be greater than for conventional girders, they are normally still within acceptable limits. Flexural stiffness can, if necessary, be increased (fig. 5). Girders with external tendons beneath the cross-section have the following advantages:

1. A simple shape for the cross-section which eliminates horizontal construction joints and thus improves the quality of the concrete.
2. Good cracking behaviour compared to externally prestressed box girders, since the cracking moment is reached only after relatively large deformations of the girder and increases in strain in the external tendons.
3. Ease of adjustment of roadway profile by subsequent stressing of external tendons to compensate for long-term deflections
4. Excellent ductility and behaviour at ultimate limit state. External tendons and internal reinforcement reach yield at roughly the same load.

(b) *Launched girders.* It is normally more economical to launch steel plate girders or steel trusses for the webs. Following this, a bottom slab can be cast near the supports, followed by the deck slab, both in concrete. External tendons are then put into place and anchored into the concrete. They are stressed corresponding to the progress of construction of the deck slab.

Cable-stayed bridges have normally been built with tall, slender towers to minimize the quantity of steel in the stay cables. This arrangement results in large bending moments in the towers due to partial live load, which are normally reduced through the use of backstay cables. A flexurally stiff girder is also required when cables are arranged in a harp pattern.

Stiffer, lower towers enable the use of the full range of effective depth of cross-section, from classical cantilever girders to classical cable-stayed bridges (fig. 6). In such systems, the tower acts as a cantilever and requires neither backstays nor a flexurally stiff girder. Since the tower is effectively prestressed by the axial force due to dead load of the girder, relatively little reinforcement is required to resist bending moments due to live load. This system enables the use of slender girders and side spans which can be greater than 50 percent of the main span length since backstay cables are no longer required. Although such systems require a greater consumption of steel in the stay cables, savings in tower costs are possible. For multiple-span cable-stayed bridges with tall piers, this system results in favourable structural behaviour and an aesthetically convincing form.



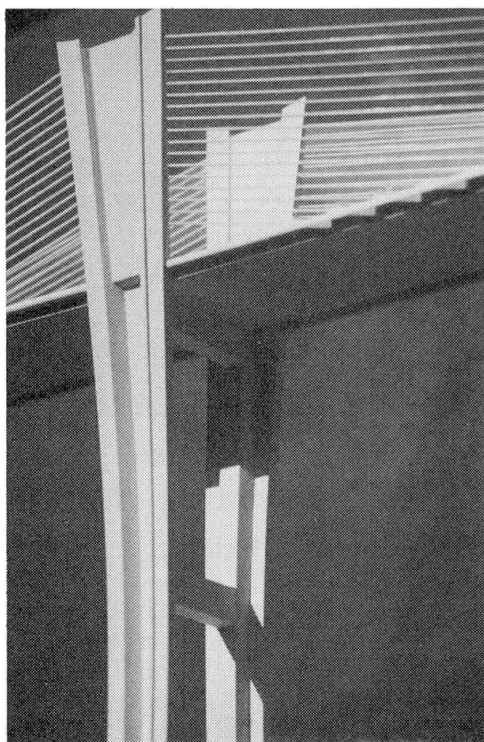

*Fig. 6 Model of flexurally stiff, low tower for cable-stayed bridges (no backstay cables required)*

Regardless of whether bonded or unbonded tendons are used, the area of prestressing steel is dimensioned together with any other reinforcement to ensure safety at ultimate limit state. Although this principle is also valid for cable-stayed bridges and bridges with external tendons beneath the cross-section, secondary effects such as curvature of the cable may also need to be considered. When unbonded tendons are used, the actual stress in the prestressing steel at ultimate limit state must be checked.

The initial stress in prestressing steel varies according to structural system. For box girders with bonded or unbonded tendons, the initial stress is taken as high as possible, normally 70 percent of yield stress. This ensures that the cracking load is as high as possible and the increase in strain required to reach yield at ultimate limit state is as small as possible. (Because of loss of prestress due to friction, relaxation, shrinkage, and creep, this increment of strain is normally significantly higher than the yield strain of mild reinforcement.) Undesirable deformations of the girder due to prestressing will normally not occur when the area of prestressing steel is dimensioned according to safety at ultimate limit state.

For cable-stayed bridges and bridges externally prestressed from beneath the cross-section, the initial stress in the prestressing steel is completely determined by the deformation of the girder, i.e. the prescribed roadway profile. For such systems, the initial stress normally ranges between 30 and 40 percent of yield stress. Provided the system is sufficiently ductile and properly detailed, it is also possible to reach yield in prestressing steel at ultimate limit state.

## 5. CONCLUDING REMARKS

The arrangement of reinforcement, anchorage lengths, and splice lengths can be simply and reliably determined with the help of the truss analogy of the internal state of equilibrium. The internal state of equilibrium, i.e. the state of equilibrium of the internal tension and compression elements, is just as important as the external equilibrium of the system. The latter is often given much more than its share of analytical attention, with negligible benefit.

Dimensioning of the area of prestressing steel must always be based on safety at ultimate state. The initial stress in prestressing steel should be chosen as high as possible to improve cracking behaviour, without exceeding prescribed limits on deformations due to permanent load.