

# Analysis of the seismic response of masonry structures

Autor(en): **D'Asdia, Piero**

Objektyp: **Article**

Zeitschrift: **IABSE reports = Rapports AIPC = IVBH Berichte**

Band (Jahr): **70 (1993)**

PDF erstellt am: **22.07.2024**

Persistenter Link: <https://doi.org/10.5169/seals-53308>

## **Nutzungsbedingungen**

Die ETH-Bibliothek ist Anbieterin der digitalisierten Zeitschriften. Sie besitzt keine Urheberrechte an den Inhalten der Zeitschriften. Die Rechte liegen in der Regel bei den Herausgebern.

Die auf der Plattform e-periodica veröffentlichten Dokumente stehen für nicht-kommerzielle Zwecke in Lehre und Forschung sowie für die private Nutzung frei zur Verfügung. Einzelne Dateien oder Ausdrucke aus diesem Angebot können zusammen mit diesen Nutzungsbedingungen und den korrekten Herkunftsbezeichnungen weitergegeben werden.

Das Veröffentlichen von Bildern in Print- und Online-Publikationen ist nur mit vorheriger Genehmigung der Rechteinhaber erlaubt. Die systematische Speicherung von Teilen des elektronischen Angebots auf anderen Servern bedarf ebenfalls des schriftlichen Einverständnisses der Rechteinhaber.

## **Haftungsausschluss**

Alle Angaben erfolgen ohne Gewähr für Vollständigkeit oder Richtigkeit. Es wird keine Haftung übernommen für Schäden durch die Verwendung von Informationen aus diesem Online-Angebot oder durch das Fehlen von Informationen. Dies gilt auch für Inhalte Dritter, die über dieses Angebot zugänglich sind.

## Analysis of the Seismic Response of Masonry Structures

Analyse du comportement séismique des structures en maçonnerie

Analyse des Erdbebenverhaltens der Mauerwerksbauten

### Piero D'ASDIA

Assoc. Professor  
Univ. "La Sapienza"  
Rome, Italy



P. D'Asdia, born 1946, got his civil engineering degree in 1971 at the University of Rome "La Sapienza", where he worked as a researcher. In 1980, he became assistant professor and is now associate professor. Since 1971 he was involved in research in several fields of structural engineering, namely: elastic stability, structural optimization, finite element technique for the analysis of degrading and geometrically non-linear structures.

### SUMMARY

For the analysis of the seismic response of masonry structures a number of procedures are available, which can be arranged in two groups: the first includes methods following the finite element approach, the second consists of procedures modelling only anticipated behaviour and collapse modes. Methods pertaining to both groups are taken into consideration, factors in favour or against their use for the analysis of different types of masonry structures are discussed. For evaluating the ultimate strength of walls subject to horizontal forces in their plane a method incorporating favourable features of both groups is proposed.

### RÉSUMÉ

Pour l'analyse du comportement séismique des structures en maçonnerie, il existe de nombreuses procédures qu'on peut répartir en deux groupes: L'une comprenant les méthodes obtenues avec l'approche des éléments finis; et l'autre groupant les procédures qui modèlent les comportements et les modes de rupture déterminés préalablement. Cet article considère les méthodes des deux groupes et analyse les éléments en faveur ou contraires à leur emploi dans l'analyse de structures en maçonnerie. Afin d'évaluer la résistance des parois exposées aux forces horizontales dans leur plan, on propose une méthode qui présente des caractéristiques favorables des deux groupes.

### ZUSAMMENFASSUNG

Für die Erdbebenanalyse der Mauerwerksbauten sind verschiedene Verfahren verfügbar. Sie sind in zwei Gruppen aufgeteilt: Die erste umfasst Methoden auf der Basis Finiter Elemente; die zweite Verfahren, nach denen voraussichtliches Verhalten und Bruchformen modelliert werden. Die Methoden beider Gruppen werden berücksichtigt und die zugunsten oder gegen ihre Verwendung bei verschiedenen Arten von Mauerwerksbauten wichtigen Elemente hervorgehoben. Um die Bruchfestigkeit der Wände gegenüber horizontal wirkenden Scheibenkräften zu bewerten, wird eine Methode vorgeschlagen, die geeignete Eigenschaften beider Gruppen verbindet.



## 1. INTRODUCTION

When the structural behaviour can be schematised as elastic-linear, the analysis of the dynamic response to seismic action is accurately performed through a mode-superposition procedure with the response spectrum technique. The ductility factor method allows the extension of such approach to structures characterised by elastic-perfectly plastic behaviour.

Even when the elastic behaviour is not linear (geometric non-linearity) or when the evaluation of the local ductility is required, the dynamic non linear seismic response of the structure can be analysed through the step by step integration of the equations of motion under a suitable set of accelerograms, recorded and/or numerically generated. Such approach requires a larger expenditure of computing effort, but the increase of personal computer power and the wide diffusion of general purpose non-linear programs (ADINA, ANSYS, etc.) implemented on personal computer, allow many designers to analyse with good accuracy the seismic response of large non-linear structures, as far as the constitutive law of structural material and elements can be reasonably assumed as elastic-plastic (even if hardening or softening and non-holonomic).

Unfortunately, the behaviour of most unreinforced masonry structures can't be assumed as plastic and is instead ruled by tension cracking, very low ductility in compression and shear strength variable according to the normal stress state, due to cohesion and internal friction. In such situation, the use of general purpose computer program (e. g. using in ADINA finite element ruled by the concrete law) for performing dynamic analysis provides significant results only associated to a high degree of discretization, usually attainable only for small structures.

Recently have been developed specific finite elements models (e. g. [1, 2, 3]) which represent typical features of masonry behaviour as an adequate schematization of the ultimate strength domain in the  $\sigma_1$ - $\sigma_2$ - $\tau$  field, a satisfactory modelling of every allowable stress-strain path under monotone loading (descent branch included) and a sufficient ability to describe opening and closing of cracks and material degrading. They are a useful tool to understand the behaviour of typical structural elements under cyclic actions, allowing comparison with experimental results [4] and identification of the ruling parameter (see in fig. 1 the comparison between numerical and experimental results for a reinforced masonry panel under horizontal load [5]), but even they are non suitable for the analysis of the dynamic response of large masonry structures, non only for the intractable dimension of the problem, but also because many other uncertainties (e. g. the peculiar behaviour of the junctions between structural elements, often providing only unilateral constraints) add to the intricacy of the material behaviour.

If the above mentioned considerations point out that dynamic analysis is usually inappropriate or not applicable to define the response of masonry structures to seismic actions, then the evaluation of the ultimate strength to static forces (suitably simulating an approximate conservative distribution of inertia forces) appears more meaningful and the simpler procedures needed for such evaluation are less influenced by uncertainties on the material characteristics. That applies also and mainly to large and complex buildings like palaces and churches, dynamic analysis providing an important tool only for the analysis of simpler monuments, like columns and arches, made of large stone blocks simply superimposed, whose response is governed by the frictional behaviour of the joints, which is ruled by a degrading Mohr-Coulomb relationship between the limit shear stress and the normal stress [6, 7, 8, 9].

Assuming thus as a measure of seismic resistance the entity of suitable static loads which attains the ultimate strength of the structure, the distribution of such forces and the procedure for the evaluation of their limit value depend mainly on the structural type.

In the general case (churches, complex buildings and other structures) both horizontal and vertical forces have to be taken into account and their limit value should be evaluated through finite element modelling and non linear analysis procedure.

In the particular but frequent case, instead, of palaces where floors act as rigid diaphragms, being the seismic action sustained mainly by the strength of the walls in their plane, horizontal forces are normally of greater importance than the vertical ones and, for the evaluation of their limit value, a number of methods have been proposed which determine the ultimate strength of the walls according to one or more collapse mechanism (with better performance of those methods which take into account more mechanism and less arbitrary hypotheses on the stiffness of the elements involved).

In the next two sections the more suitable analysis procedures are considered for the two aforementioned cases.

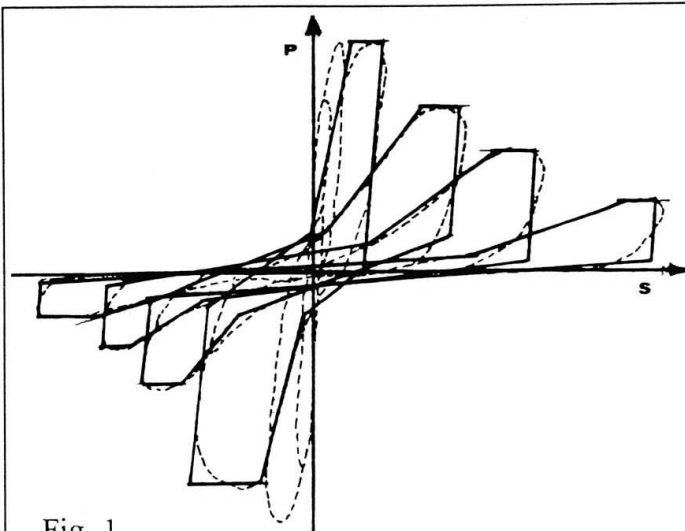

Fig. 1

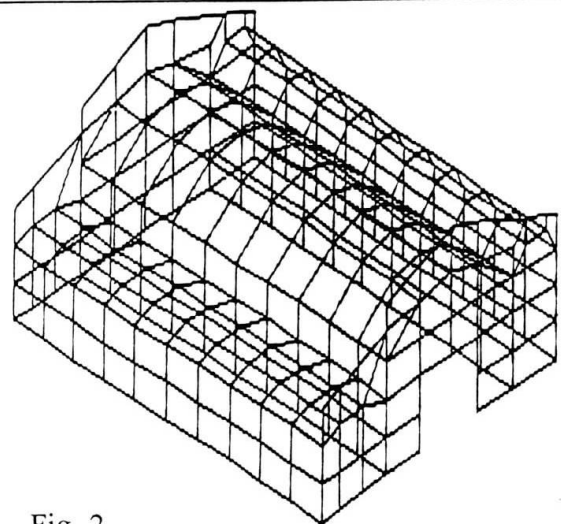

Fig. 2

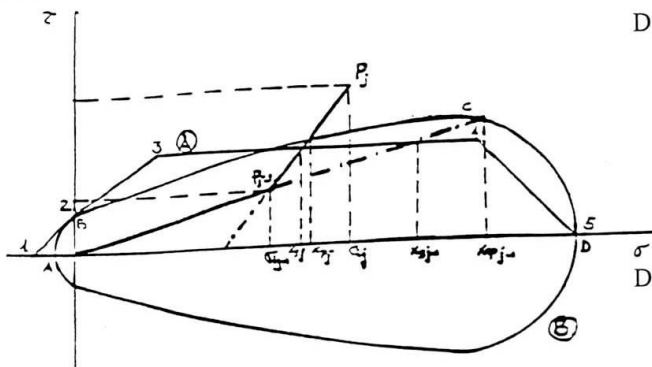

Fig. 3

- Domain A.
- point 1:  $\sigma_1 = \sigma_{int}, \tau_1 = 0$
  - point 2:  $\sigma_2 = 0, \tau_2 = \sigma_1 k_1$
  - point 3:  $\sigma_3 = C_1 \sigma_{inc} k_2 - \sigma_{int}, \tau_3 = C_1 \sigma_{inc}$
  - point 4:  $\sigma_4 = \sigma_{inc}(1 - C_1 k_2), \tau_4 = C_1 \sigma_{inc}$
  - point 5:  $\sigma_5 = \sigma_{inc}, \tau_5 = 0$
- Domain B.
- point A:  $\sigma_A = \sigma_{int}, \tau_A = 0$
  - point B:  $\sigma_B = 0, \tau_B = \tau_k$
  - point C:  $\sigma_C = \sigma_4, \tau_C = \tau_k \sqrt{(1 + 1.5\sigma_4/\tau_k)}$
  - point D:  $\sigma_D = \sigma_{inc}, \tau_D = 0$

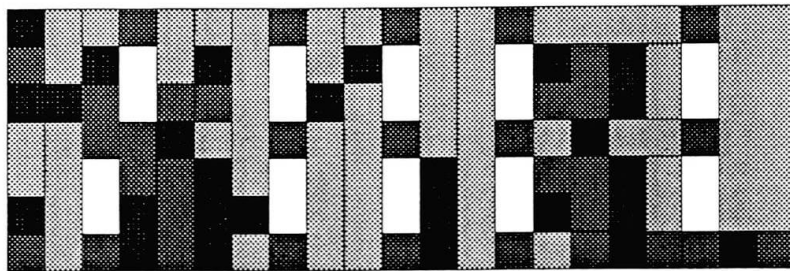

Fig 4.a

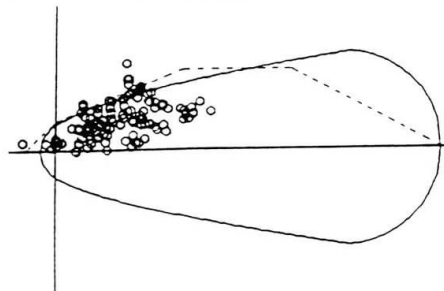
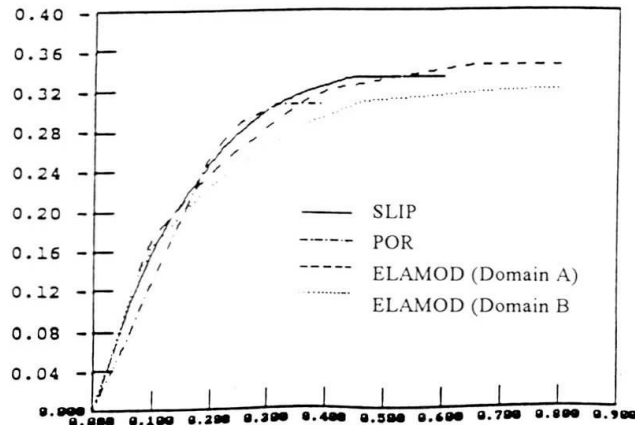

Fig. 4.b

Horiz. Force

Dead Load



Displacement (cm)

Fig. 5



## 2. GENERAL CASE: FINITE ELEMENT APPROACH

Static analysis to determine the collapse load can be performed following the non linear force-deflection path through already mentioned general purpose programs or specific ones. Using plate or shell (or brick) elements, with correct values of the uniaxial strength of the masonry, fragility in tension and prefixed (low) ductility in compression, even if the discretization is not refined, the ultimate strength domain is not completely correct and the elastic characteristic are only approximated, the results provided by the static analysis are usually quite significant.

An useful alternative to the use of non linear programs, which are still non familiar to many designers, is to perform an incremental analysis, piece-wise linear, through a procedure that automatically repeats subsequent runs of a well known linear program (SAP90, SUPERSAP, etc.) suitably changing the data files of the runs.

Synthetically the procedure (named ELAMOD [10]) can be described as follow:

- a data file is prepared describing for a linear program the structure (usually discretized into plate elements) with the dead loads and the live loads to be increased up to the collapse;
- another data file is prepared containing, for the different types of elements describing the structure, the limit domains  $\sigma$ - $\tau$  and the allowable ductility in compression along two orthogonal directions (alternatively three-dimensional  $\sigma_1$ - $\sigma_2$ - $\tau$  domain could be used but that is normally not necessary and often non advisable as a too rigid constraint);
- a set of runs are done, the first under dead loads, the subsequent ones under unitary values of the live loads, for each of them a multiplier of the loads is computed which brings stresses or strains of an element, added to those of the previous steps, respectively to the border of a strength domain or to the end of the allowable ductility;
- after each run the structural data file is updated zeroing (or strongly reducing) the stiffness of the element attaining the domain border and/or cancelling the elements reaching the ductility end and applying to the remaining structure the forces carried by them up to that step;
- the procedure stops when the remaining structure can't carry more loads or when part of it is no more constrained.

In comparison with the use of non linear programs, the described procedure presents both advantages and disadvantages, namely:

- the procedure is easy to implement in any computer language (FORTRAN, BASIC, etc.) without being a skilled programmer, moreover, using widely adopted linear programs, it allows designers to prepare data files in the way they are used to; e. g. in fig. 2 is shown the sample presented in [10];
- limit domain shapes can be easily changed, in fig. 3 are shown two possible choices: domain A has a multilinear border (characterised by the three zones of collapse for overturning, shear and compression), domain B is formed by a POR-like curve  $\tau_{ult} = f(\tau_k, \sigma)$  limited by circular arches in compression and in tension; analogously others typical features can be easily changed as the mutual influence of the checks along the two orthogonal directions (e. g.: a good choice can be to ignore a modest violation of the border in the tension side if the representative point in the other direction shows a stress state in compression inside the domain);
- reinforcements or frames can be taken into account easily, adding truss or beam elements to the mesh, if necessary a plasticity check of the reinforcements can be performed too;
- the interpretation of the results is easy; e. g. in fig 4 is shown one of the walls of the sample presented in fig. 2, in fig. 4a the element nearer to the border (or in ductile phase) are darker, in fig. 4b are presented the positions of the points representing the stress state of the elements;
- the results are in good agreement with those given by non linear programs, in fig. 5 is compared, for the sample of fig. 2, the equilibrium path obtained through the described procedure with the load-displacement curve given by the non linear program presented in [1, 3, 4]: the results obtained with the same procedure are very near and differ less than those given by the same procedure but with different domains;
- the procedure is numerically not efficient, the required computer time is considerably higher than for non linear programs (up to a few times);

Particular attention should be paid, in both cases of using non linear programs or the described incremental procedure, to the sensitivity of the results to the shape of the limit domains and to the extension of the ductile phase, as well as to the choice of the live load distribution, which should represent significantly the seismic action. In any case of high sensitivity, parametric analysis has to be performed.

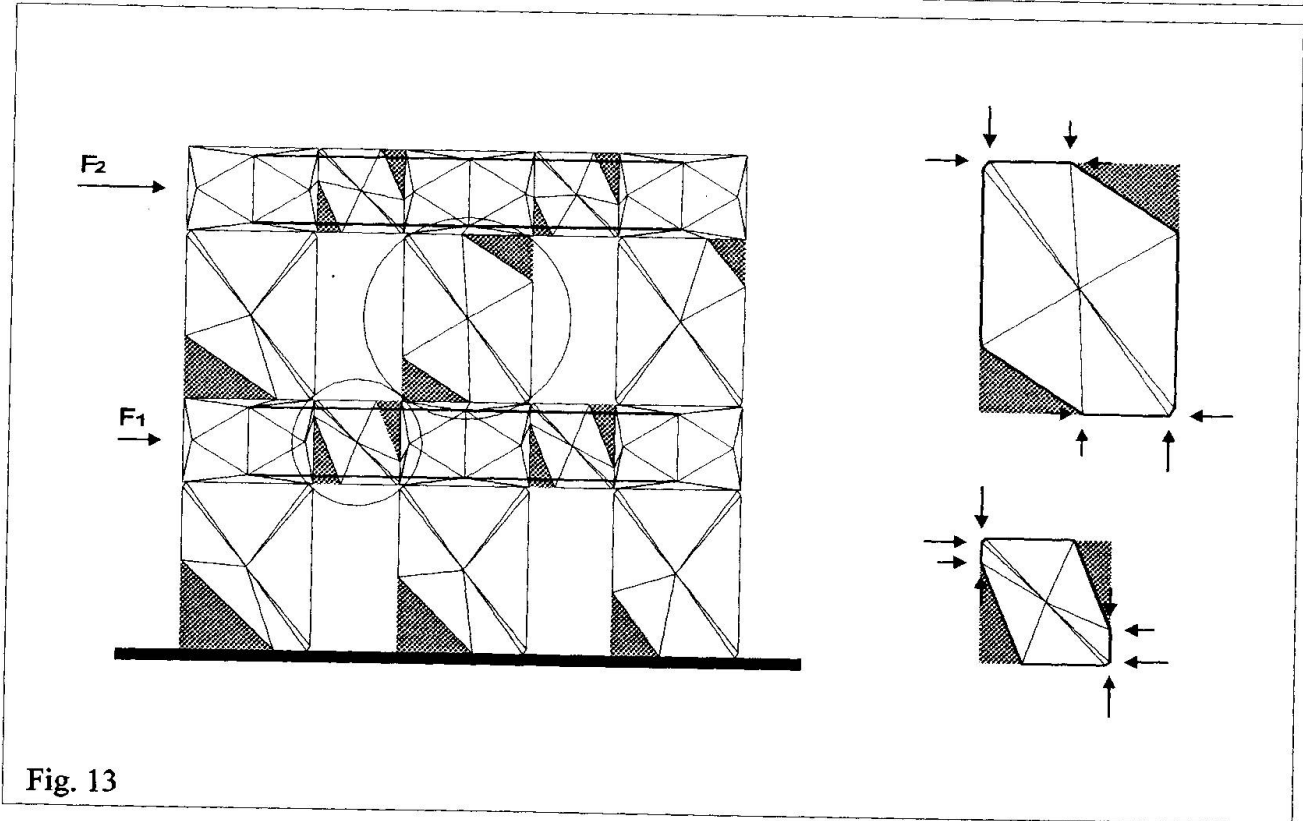
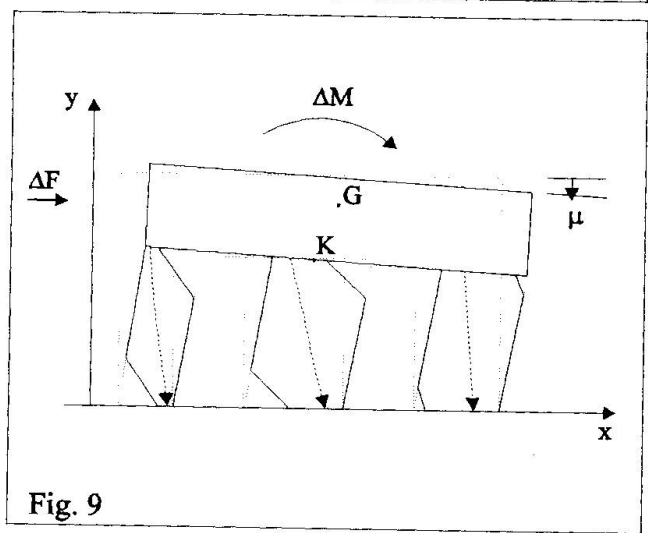
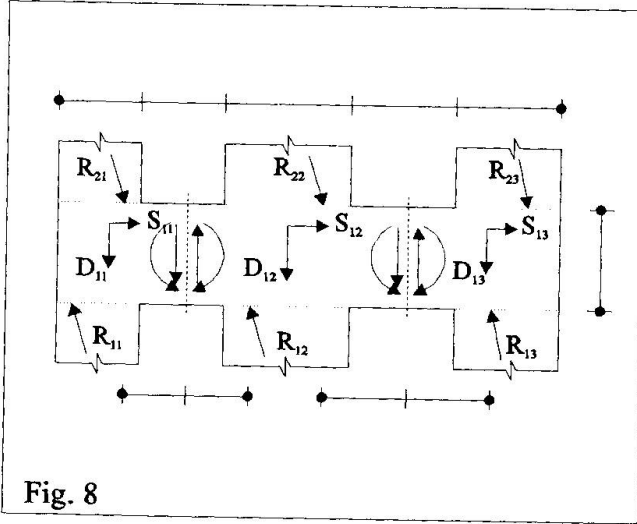
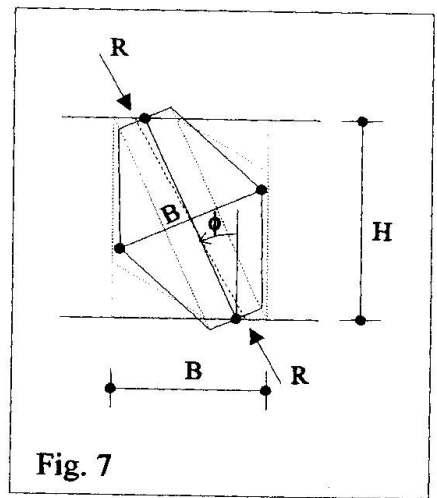
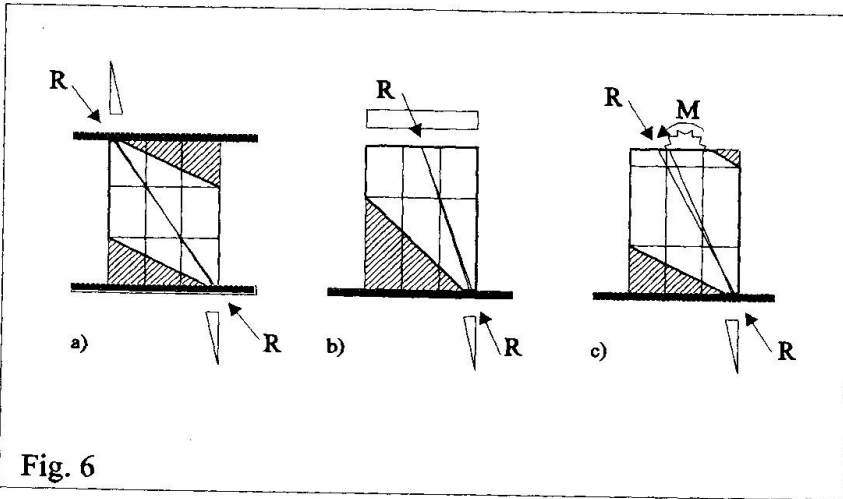



### 3. PROCEDURES FOR EVALUATING MULTI-STOREY WALLS STRENGTH

As already mentioned, buildings with rigid floors, like many palaces, sustain global seismic forces through the strength of the walls in their plane; thus (provided a satisfactory behaviour of the walls with respect to the local action of forces acting in the orthogonal plane), the evaluation of the ultimate strength of the building is easily reduced to the problem of finding the collapse load of the walls.

Buildings damaged by earthquake can present most cracks (usually X shaped) either in the vertical panels between openings of the same floor, or in the horizontal bands between openings of two different floors; the first case represent a shear type behaviour where masonry bands between floors are stiffer and stronger than vertical panels, while in the second case the weaker bands crack first and vertical panels behave as multi-storey cantilever. It is worth noticing that, according to models providing no tensile strength to masonry, the first type of behaviour could not happen without reinforcements in the bands. It is also important to note that the collapse load of the wall, for equal dimensions and strength of the vertical panels, is higher according to the first type of behaviour than to the second one. In fact, in the shear-type behaviour the resultant of the vertical and horizontal forces rotates around the centre of the panel, fig. 6a (the horizontal sections where such resultant is out of the middle third part are partialized according to the low tensile resistance of the masonry). In the case, vice versa, of a cantilever-like behaviour the resultant of the forces rotates around the middle point of the upper section of the panel, fig. 6b. In the other (real) cases the resultant of the forces rotates around points situated between the centre of the panel and the middle point of its upper section, fig. 6c. Therefore, for equal values of vertical load and masonry strength, the shear-type behaviour leads to higher horizontal force at collapse.

For this reason technical rules in many countries prescribe to reinforce the horizontal bands between floors, and specific procedures have been proposed to evaluate the horizontal limit load (for each floor) according to that model of behaviour.

The first one was the well known POR method, which, even if it is still used by designers, was considered unsafe, as it takes into account only shear failure of the vertical panels. Two kinds of improvements were then proposed, the first one [11] adds, in a frame-like evaluation, a verification of the normal stress due to axial force and bending; the second one [12, 13] tests the axial and shear strength of the compressed beam of variable cross-section formed inside each vertical panel, inclined according to the direction of the vertical and horizontal forces resultant applied to the panel, fig. 7.

The last two approaches take into account (in different way) the three main mode of failure of each panel (overturning, shear and compression) and the local breaking of the continuity constrain between vertical panels and horizontal bands. The second procedure [13] provides also the amount and type of reinforcements in the bands necessary to fulfil the hypothesis that bands do not break, fig. 8, and, if the case, it takes into account both the contribution to equilibrium of the vertical reinforcements (prestressed or not) in the panels, and the variation of the ultimate strength in compression with the inclination of the resultant. The wall ultimate strength of each floor is computed separately through 3 equilibrium equation according to the hypothesis of rigid bands; it is worth noticing that in such way compatibility of the vertical panel displacements with the rigid band of each floor is automatically assured, while the evaluation of global effects, as transferring of vertical loads, is only approximate, fig. 9.

When the horizontal bands between floors are not enough strong and/or can't be adequately reinforced, as an alternative to the general procedures mentioned in the previous section, the following method can be employed, based on finite elements of variable shape, which presents some advantages in computer time and in easy understanding of results, while no hypothesis is introduced about the stiffness and strength of the wall elements (as in [11, 12, 13]).

The procedure follows step by step the evolution of the resisting part of the wall; initially the structure (panel and band elements) is discretized through a mesh of triangular f. e., as shown in fig. 10 for a vertical panel. As the load increases, the shape of the elements is changed, fig. 11, eliminating the zones where the tension in the masonry is greater than zero or a small allowable value, in fig. 12 are shown both cases. The change of shape is obtained through a suitable translation of the joints, while the state of stress of the elements is changed in such a way to leave unchanged the resultant at each panel end (this condition is easy to obtain with triangular

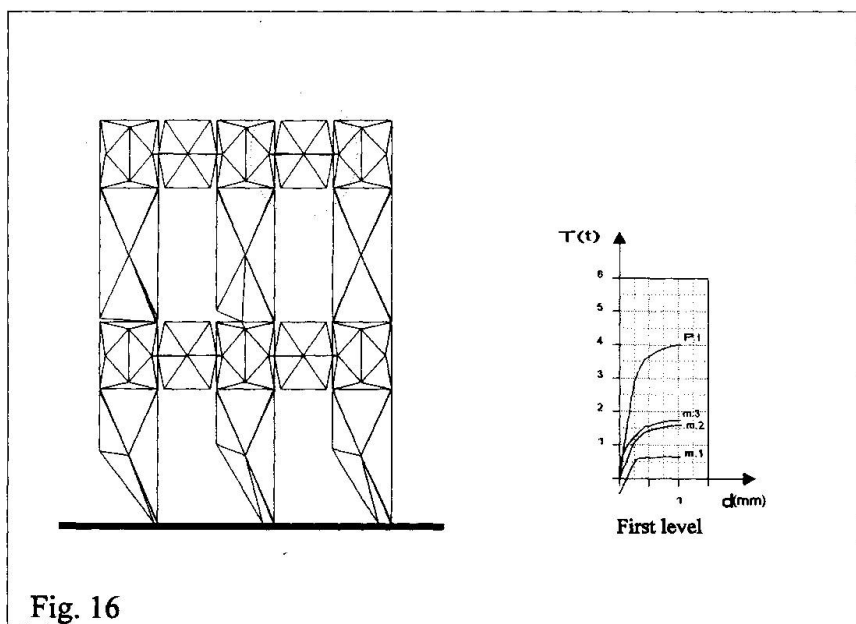
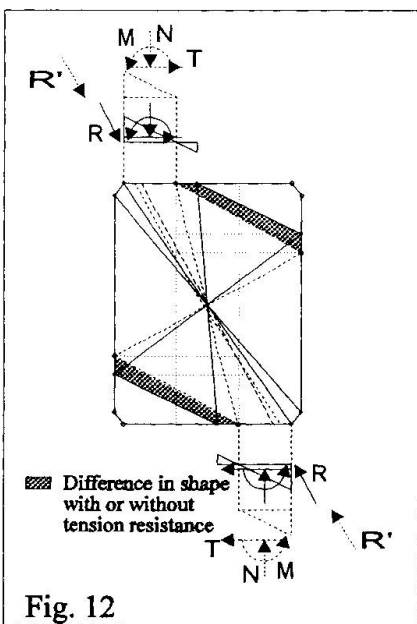
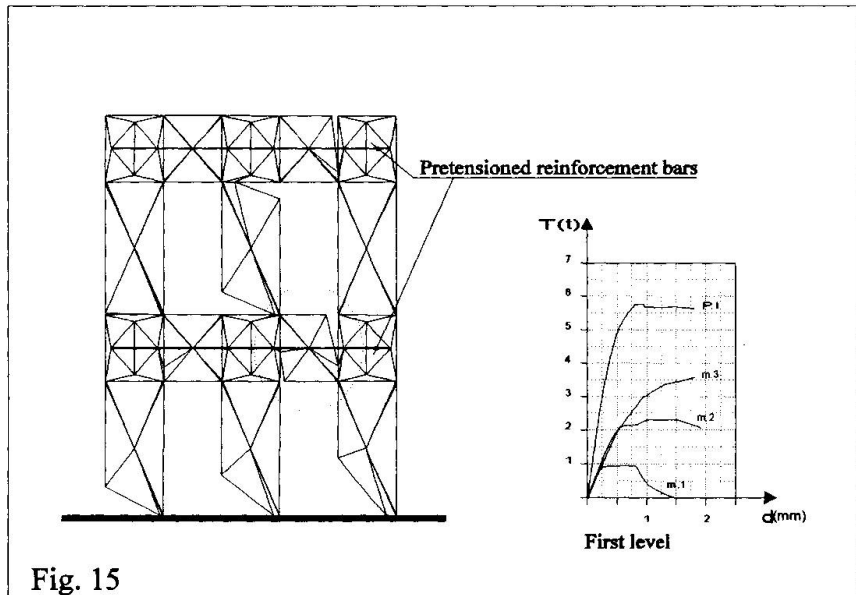
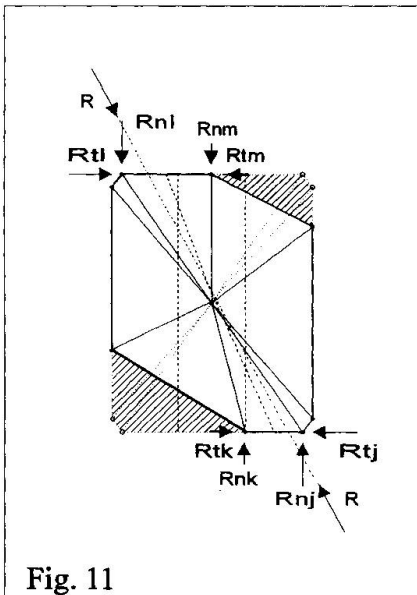
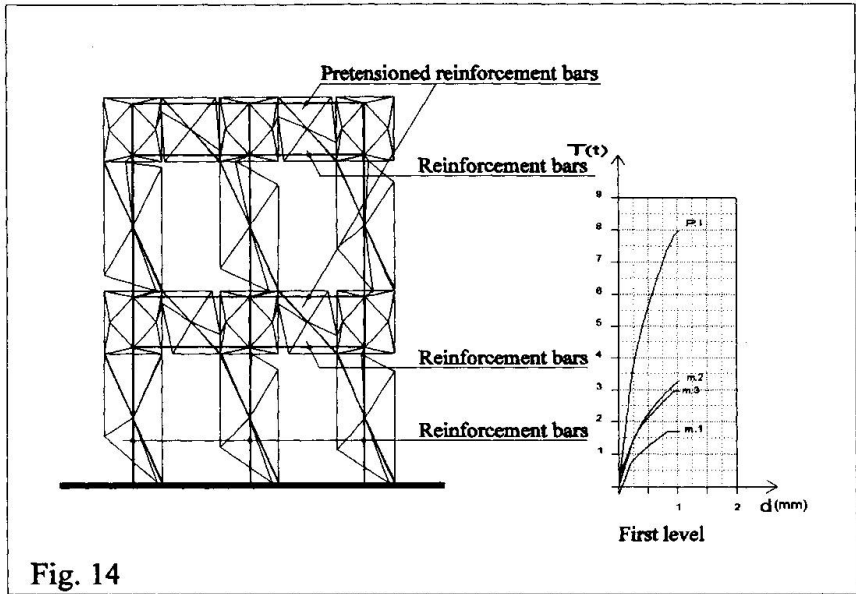
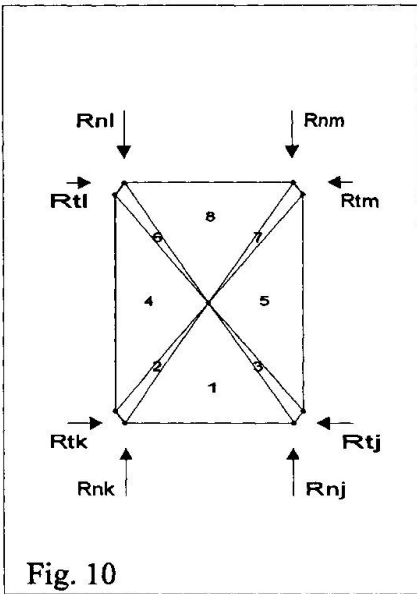





constant strain f. e., and leads to results comparable, in term of generalised stresses, with those given by more complex f. e. approach).

Fig. 13 shows a typical situation of a wall during a loading history. The proposed procedure allows also easily the introduction into the model of reinforcements both horizontal in the bands and vertical in the panels (they can be linked to the joints of the bands also through slipping connection). Fig 14 shows the situation, at collapse, of a wall with reinforcements bars (prestressed in the bands and not prestressed in the vertical panels), in the same figure are shown also the horizontal force - displacement diagrams of the first floor panels and of the whole structure; it is interesting to compare such diagrams with those in fig. 15, regarding the same wall but with reinforcements in the centre of the bands only (same total amount of steel in the bands and same pretension), and with those in fig. 16, regarding the same wall without any reinforcement.

#### 4. ACKNOWLEDGEMENT

The author is indebted to dr. Alberto Viskovic who implemented the computer program according to the procedure for evaluating the ultimate strength of walls proposed in the present paper.

#### 5. BIBLIOGRAPHY

- [1] U. ANDREAUS, M. CERONE, P. D'ASDIA, F. IANNOZZI, "A Finite Element Model for the Analysis of Masonry Structures under Cyclic Actions", 7<sup>th</sup> IBMaC, Melbourne, 1985.
- [2] F. MOTTA, "MASAN - Un codice di calcolo automatico per l'analisi non lineare delle strutture murarie", Atti Istituto di Scienza delle Costruzioni, Università di Catania, n. 74, 1987.
- [3] G. CROCI, P. D'ASDIA, A. DI PAOLO, "Risultati e recenti sviluppi nella definizione teorica delle caratteristiche dei materiali e degli elementi murari", 3<sup>o</sup> Congresso Nazionale ASS.I.R.C.CO - Catania 1988.
- [4] U. ANDREAUS, M. CERONE, G. CERADINI, P. D'ASDIA, "Masonry Columns under Horizontal Loads", 7<sup>th</sup> IBMaC, Melbourne, 1985.
- [5] P. D'ASDIA, "Influenza della legge di degradazione nella modellazione dei legami costitutivi isteretici", Volume: "Omaggio a Giulio Ceradini", Università di Roma, 1988.
- [6] U. ANDREAUS, P. D'ASDIA, A. DI PAOLO, "Sul comportamento di giunti fra conci lapidei: un modello di giunto attritivo", 3<sup>o</sup> Convegno Nazionale "L'Ingegneria Sismica in Italia", Roma, 1987.
- [7] P. D'ASDIA, D. D'AYALA, "L'Analisi del comportamento attritivo di murature costituite da grande blocchi a secco", 5<sup>o</sup> Convegno Nazionale "L'Ingegneria Sismica in Italia", Palermo, 1991.
- [8] R. GIANNINI, A. GIUFFRE', R. MASIANI, "La dinamica delle strutture composte di blocchi sovrapposti: studi in corso sulla Colonna Antonina", 3<sup>o</sup> Convegno Nazionale AIMETA, Torino, 1986.
- [9] A. R. LIPSCOMBE, S. PELLEGRINO, "Rocking of rigid-block systems under dynamic loads", Applied Solid Mechanics, 3, London, 1989.
- [10] G. CROCI, P. D'ASDIA, D. D'AYALA, "Verifica delle pareti murarie soggette al sisma e definizione degli interventi di rinforzo", 4<sup>o</sup> Convegno Nazionale "L'Ingegneria Sismica in Italia", Milano 1989.
- [11] F. BRAGA, M. DOLCE, "A method for the analysis of antiseismic masonry multi-story buildings", 6<sup>th</sup> International Brick Masonry Conference, Rome 1982.
- [12] B. CALDERONI, P. MARONE, M. PAGANO, "Modelli per la verifica statica di edifici in muratura in zona sismica", Bradisismo e fenomeni connessi, Napoli, 1987.
- [13] P. D'ASDIA, F. PALOMBINI, A. VISKOVIC "Un modello di Setto Inclinato a Sezione Variabile per l'analisi delle pareti murarie", Quaderni del Dip. di Ingegneria Strutturale e Geotecnica, Università "La Sapienza", Roma, 1992.