

# European rules for the design of composite joints

Autor(en): **Anderson, David**

Objekttyp: **Article**

Zeitschrift: **IABSE reports = Rapports AIPC = IVBH Berichte**

Band (Jahr): **75 (1996)**

PDF erstellt am: **22.07.2024**

Persistenter Link: <https://doi.org/10.5169/seals-56908>

## **Nutzungsbedingungen**

Die ETH-Bibliothek ist Anbieterin der digitalisierten Zeitschriften. Sie besitzt keine Urheberrechte an den Inhalten der Zeitschriften. Die Rechte liegen in der Regel bei den Herausgebern.

Die auf der Plattform e-periodica veröffentlichten Dokumente stehen für nicht-kommerzielle Zwecke in Lehre und Forschung sowie für die private Nutzung frei zur Verfügung. Einzelne Dateien oder Ausdrucke aus diesem Angebot können zusammen mit diesen Nutzungsbedingungen und den korrekten Herkunftsbezeichnungen weitergegeben werden.

Das Veröffentlichen von Bildern in Print- und Online-Publikationen ist nur mit vorheriger Genehmigung der Rechteinhaber erlaubt. Die systematische Speicherung von Teilen des elektronischen Angebots auf anderen Servern bedarf ebenfalls des schriftlichen Einverständnisses der Rechteinhaber.

## **Haftungsausschluss**

Alle Angaben erfolgen ohne Gewähr für Vollständigkeit oder Richtigkeit. Es wird keine Haftung übernommen für Schäden durch die Verwendung von Informationen aus diesem Online-Angebot oder durch das Fehlen von Informationen. Dies gilt auch für Inhalte Dritter, die über dieses Angebot zugänglich sind.



## European Rules for the Design of Composite Joints

**David ANDERSON**  
Reader  
University of Warwick  
Coventry  
UK



David Anderson, born 1944, received his degrees from the University of Manchester. His interests include the drafting and assessment of codes for steel and composite structures. He is Convenor of the Project Team for conversion of ENV1994-1-1 to a European Standard.

### Summary

Conversion of Eurocode 4 from an ENV to EN-status provides an opportunity to publish detailed rules for composite joints, based on the component approach of the revised Annex J of Eurocode 3. This paper outlines the present draft rules and indicates where further development is still desirable, both in format and technical content.

### 1. Introduction

It has long been recognised that in a structural frame continuity provides a means to reduce member sizes. In steel construction however, the potential for economy is often lost because of the cost of fabricating the stiffened joints necessary to provide full continuity. For multi-storey buildings it is therefore established practice to design the frame as a 'simple' pin-jointed structure, but with composite action being used to reduce section sizes.

In bridges though, it is common to design the longitudinal girders as continuous composite members, reinforcement being provided in the deck to assist in resisting hogging moments over the intermediate supports. In buildings the beams are broken by the columns, but designers are now being encouraged to restore a measure of continuity by using 'composite joints' [1]. With hogging moments, the tensile action of the reinforcement results in a joint of substantial stiffness and moment resistance, even though the connection between the steel sections may be of a form associated with simple construction (Fig. 1).

Such an approach for braced frames is recognised by Eurocode 4 [2], in which a composite joint may be full-strength or partial-strength, depending on its resistance relative to that of the connected beam in hogging bending. This classification is relevant to frames designed plastically, as it determines whether it is the properties of the joint or the beam that are relevant to the analysis. For elastic global analysis though, the designer needs to know if the joint is sufficiently stiff for local deformations to be ignored. In this case joints are classified as rigid, semi-rigid or pinned, depending on the rotational stiffness of the joint relative to that of the beam (Fig. 2). Consistent application of this system depends though on agreed methods to determine the properties of the joint. Such methods are given in Eurocode 3 [3, 4] for several types of steel joint.

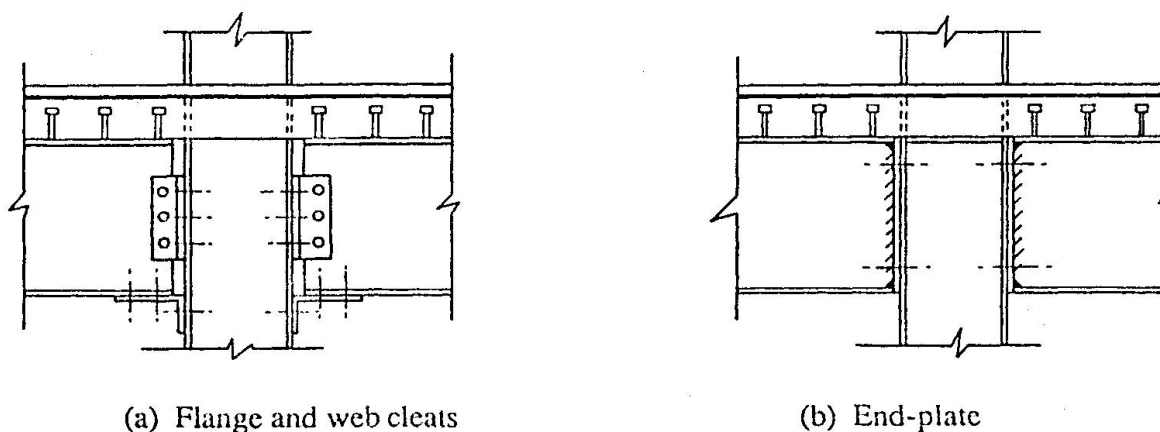

Fig. 1 Composite joints

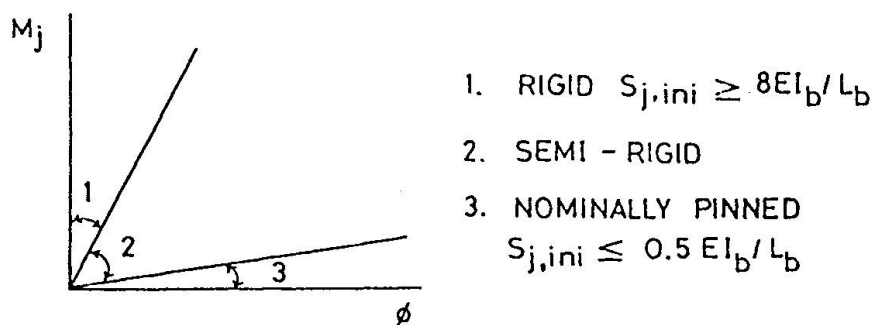

Fig. 2 Classification by stiffness

In contrast, Eurocode 4 as an ENV does not provide rules to calculate composite joints, because, at the time of drafting, the conclusions from research were judged not to be sufficiently well-established. However, work is in progress to prepare an annex on this topic for inclusion in the EN version of Eurocode 4 : Part 1.1. This is being carried out by collaboration between Technical Committee 11 of the European Convention for Constructional Steelwork and Project C1 of the programme for European Cooperation in the Field of Scientific and Technical Research (COST). The drafting group comprises the present author and the following colleagues: J.-M. Aribert (Rennes), G. Huber (Innsbruck), J.-P. Jaspart (Liège), H.J. Kronenberger (Kaiserslautern), J.W.B. Stark (Delft), F. Tschemmerneegg (Innsbruck) and Y. Xiao (Southampton).

This paper describes the draft annex in outline, and includes references to background studies. Readers should be aware that during development of the rules some changes have been made to the original intentions described previously [5].

## 2. Format of Eurocode 4 : Part 1.1 as EN 1994-1-1

Before publication as EN documents, the sequence of sections (formerly known as chapters) in Eurocodes 2, 3 and 4 will be harmonised as far as the different technical contents sensibly permit. For EN 1994-1-1, the proposed order is :

1. General
2. Basis of design



3. Materials
4. Durability
5. Basis for structural analysis
6. Ultimate limit states
7. Serviceability limit states
8. Shear connection
9. Composite slabs
10. Execution
11. Design assisted by testing

In this spirit of harmonisation, the general layout of the draft annex follows that of the revised Annex J for Eurocode 3 [4] which consists solely of Application Rules. However, design of joints is an area in which a variety of detailed approaches has traditionally been accepted. It may be therefore that the EN texts should distinguish between Principles and Application Rules, to enable legitimate variety to continue and to avoid discouraging innovation.

The revised Annex J [4] contains some simplified methods, including detailing rules which avoid the need for quantitative checks on rotation capacity. The annex on composite joints aims to provide the same level of simplification. Neither document provides detailed formulae for the properties of complete joints. Instead, the properties of joint components are given, with guidance on how these should be assembled. This is somewhat similar to the treatment of composite beams in ENV 1994-1-1; no formulae are given for moment resistance and flexural rigidity, these being left to designers' handbooks.

### 3. Scope

#### 3.1 Types of joint model

When drafting ENV 1994-1-1, rules for stiffness of a composite joint were not established, and no guidance was therefore given concerning elastic design of frames with semi-rigid joints. A limitation to plastic analysis is restrictive though; this approach necessitates joints with substantial rotation capacity, is not widely practiced in some countries and is not appropriate for serviceability checks. In any case, a calculation method at least for initial stiffness is required if a quantitative approach is to be used in classification. As described later, rules are now available for this key property; this opens the possibility of elastic global analysis of semi-rigid composite frames, for which it is intended to provide Principles in Section 5 of EN 1994-1-1. Thus the full range of joint models envisaged by Eurocode 3 (Table 1 below) will be available for composite structures as well.

| Method of global analysis | Classification of joint |                         |   |
|---------------------------|-------------------------|-------------------------|---|
|                           | Nominally pinned        | Rigid                   | Semi-rigid  |
| Elastic                   | Nominally pinned        | Full-strength           | Partial-strength  |
| Rigid-Plastic             | Nominally pinned        | Rigid and full-strength | Semi-rigid and partial-strength<br>Semi-rigid and full-strength<br>Rigid and partial-strength |
| Elastic-Plastic           | Simple                  | Continuous              | Semi-continuous   |

Table 1. Types of joint model



### 3.2 Joint components

As explained elsewhere [6], the revised Annex to Eurocode 3 adopts a "component approach". Enough components are distinguished for the designer to build-up calculation models for bolted connections with end plates or angle flange cleats and for welded connections. The draft annex for Eurocode 4 identifies two further basic components:

- longitudinal slab reinforcement in tension
- a steel contact plate in compression.

The use of the latter is illustrated in Fig. 3(a), and this type of joint is described in the next section.

Eurocode 4 includes composite columns within its scope. For the joint any concrete encasement to the column section (Fig. 3(a)) is treated as a form of strengthening and stiffening, rather than as additional basic components.

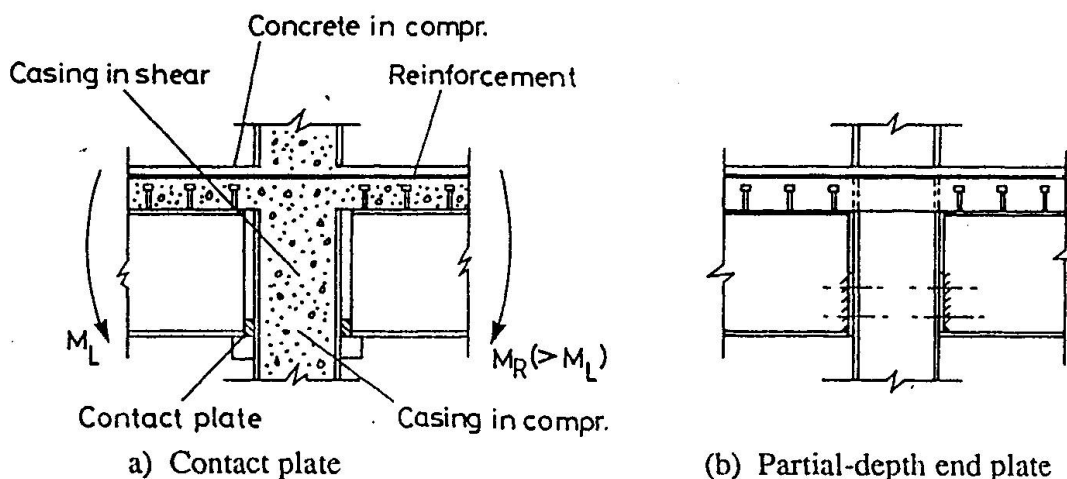
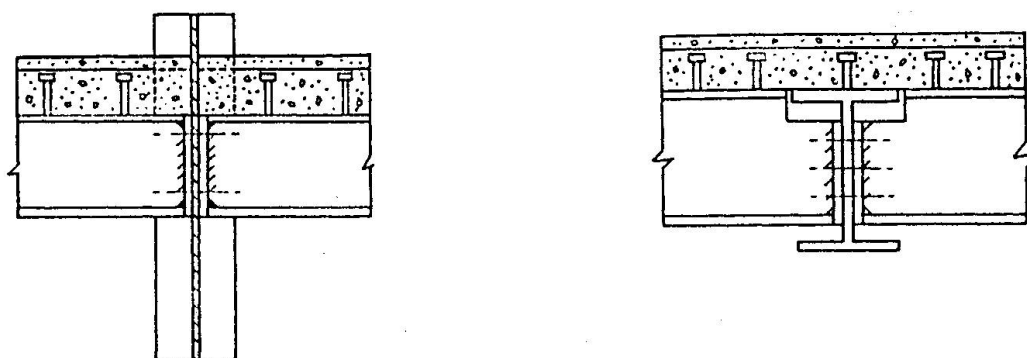

Fig. 3. Further composite joints

### 3.3 Types of joint

It follows from the component approach that it is not possible to specify the scope of the draft annex in terms of types of joint. Sufficient basic components are distinguished though to permit design of the types of composite joint shown in Figs. 1 and 3. Except for the full-depth end plate (Fig. 1(b)), these joints rely solely on the reinforcement as the component in tension. The balancing compression is then transmitted to the column through a bottom cleat, a contact plate or a partial-depth end plate adjacent to the lower part of the beam's steel section.

The components distinguished in the two annexes permit not only major axis beam-to-column joints to be designed, but also connections to the webs of column sections and beam-to-beam joints (Fig. 4), provided that no transfer of moments into the column web or the supporting beam is assumed in analysis.



(a) Minor axis joint configuration

(b) Beam-to-beam configuration

*Fig. 4 Connection to the webs of sections*

## 4. Classification and Modelling of Joints

### 4.1 Classification

Classification by strength has already been described in the Introduction.

For stiffness, the limits given in the revised Annex to Eurocode 3 are shown in Fig. 2; they relate the initial stiffness of the joint,  $S_{j,ini}$ , to that of the connected beam,  $EI_b/L_b$ . The initial stiffness is defined as the slope of the elastic range of the design moment-rotation characteristic. To avoid complication, it is convenient to treat the composite beam as a uniform member of uncracked section, but this implies that  $S_{j,ini}$  should include the stiffness of the uncracked concrete slab in the region of the joint. This is not included amongst the basic components. However, its neglect is a conservative approximation, because this makes it more difficult for a joint to reach the rigid classification.

### 4.2 Modelling

In the background studies, use is made of a sophisticated spring model [7] and this is included in the draft annex in pictorial form (Fig. 5), as a model which reflects the actual behaviour of a composite joint.

As for steel joints though, it is expected that in practice a simplified nodal representation will be adopted. Strictly, for the double-sided configuration (Fig. 6), there is interaction between the two joints, which influences the contribution of column web components to each joint. This would result in iteration, because the exact interaction is dependent on stress resultants at the ends of the connected members. Approximate values for a transformation parameter are therefore provided.

In reality the joint and its spring model (Fig. 5) have finite dimensions, but the nodal representation (Fig. 6) assumes that member deformations continue to occur within the region



occupied by the joint. Account is taken of this by a transformation procedure included where appropriate in the derivation of component properties [8].

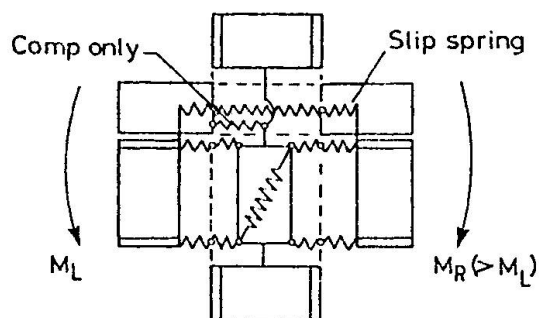

Fig. 5. Spring model

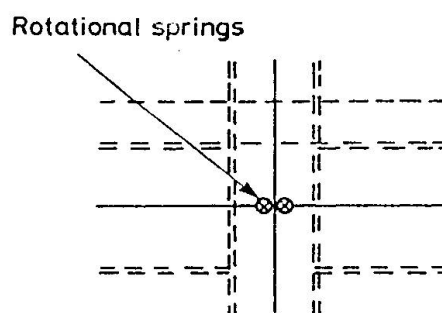

Fig. 6. Modelling for global analysis

## 5. Resistance

### 5.1 Internal forces

Although the action effects on a joint could be distributed locally to determine the internal forces to which each component is subjected, this is not the approach adopted by the detailed rules. Instead the resistance of the joint to shear force and bending moment is determined by assembling the resistances of individual components, for comparison with the 'action effects'.

### 5.2 Column web panel in shear

As mentioned earlier, concrete encasement to the web of a steel column is regarded as a form of strengthening. The concrete is assumed to act as a diagonal strut (Fig. 7). The resistance in shear is enhanced by compressive axial force in the column section, which tends to limit the maximum tensile stress in the concrete [9].

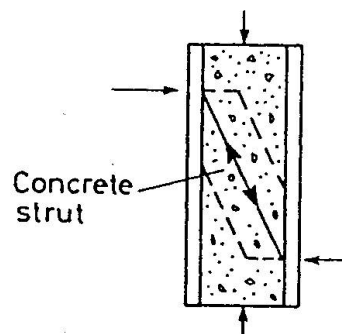

Fig. 7. Encased column web in shear

### 5.3 Column web in compression

The primary effect of the encasement is to provide additional resistance which is limited by the compressive strength of the concrete. Coexistent axial compression in the column enhances the capability to resist transverse compression.

In the draft, the resistance of the steel web is determined from the revised Annex J of Eurocode 3. However, the limitation of this resistance due to buckling should not apply when

the web is encased. Also, in background studies [10], no influence of shear on the resistance in compression was observed.

#### 5.4 Contact plate in compression

In the present draft this resistance is limited by the design strength of the steel forming the plate, but this is under review. The plate is restrained by the clamping action of the surrounding components, which will enhance the apparent strength of the plate.

#### 5.5 Longitudinal slab reinforcement in tension

The resistance of a row of reinforcing bars is determined from the design strength and the cross-sectional area of the bars within the effective width of the concrete flange.

Under unbalanced moment the concrete slab on the less heavily loaded side bears against the flange of the column. This also results in transverse tension (Fig. 8). The area of the longitudinal bars therefore needs to be limited to avoid an over-reinforced situation and transverse reinforcement should be provided.

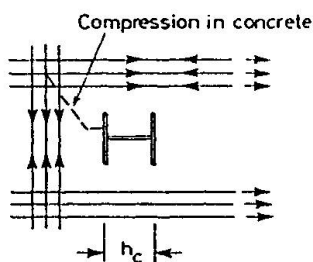

Fig. 8. Out-of-balance loading

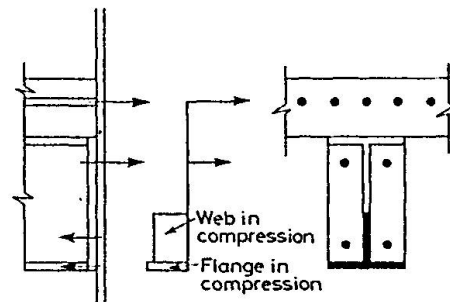

Fig. 9. Stress block analysis

#### 5.6 Beam flange and web in compression

Generally, it is assumed that the centre of compression is located at the mid-thickness of the compression flange of the beam's steel section. In Eurocode 3 the design compression resistance of a beam flange and the adjacent compression zone of the web,  $F_{c,fb,Rd}$ , is assumed to be given with sufficient accuracy by

$$F_{c,fb,Rd} = M_{c,Rd}/(h_b - t_{fb}) \quad (1)$$

where  $M_{c,Rd}$  is the design moment resistance of the beam's steel section,  $h_b$  is the overall depth and  $t_{fb}$  is the flange thickness. At present it is proposed to retain this for composite joints.

An alternative approach is to determine what proportion of the web, if any, is required to provide a plastic resistance to balance the total tensile force in the upper part of the joint, as shown in Fig. 9 [1]. Increasing use of the web to resist compression results in a reduced lever arm for the joint, but this approach permits if necessary the whole of the steel section to be in compression. However, in practice the tensile reinforcement will be limited by the need to avoid an over-reinforced joint, as explained above, and by restrictions on the number of shear connectors resulting from the spacing of the troughs in composite flooring. Equation (1) effectively assumes that up to 25% of the web may be stressed to yield in compression which, together with the flange, will provide adequate compression resistance in most cases.





## 5.7 Design moment resistance

The procedure for assembly of the basic components to determine the moment resistance of the joint will be discussed in terms of a composite joint in which the steelwork connection is by means of an end plate bolted to the column flange. The model for the joint is based on that of the revised Annex for Eurocode 3 (Fig. 10). The total resistance is obtained by taking moments about the centre of compression for the effective tension resistance of the reinforcement and the bolt rows.

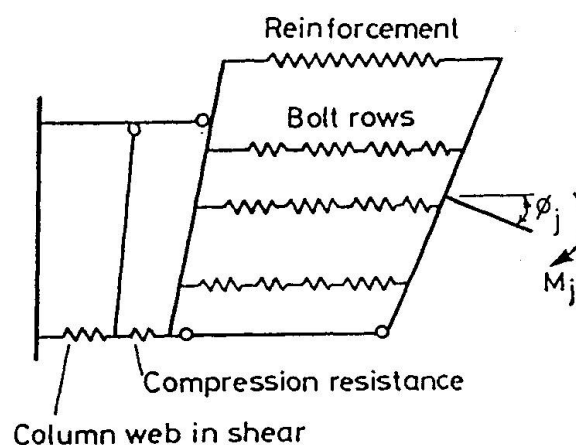

Fig. 10. EC3 mechanical model

However, it can be seen that the sum of the tensile forces cannot exceed the shear resistance of the column web, not the compression resistance of the column web or the beam's section. Thus the tensile forces in the bolt rows are reduced (to zero if necessary), commencing with the row nearest the centre of compression, until neither the shear nor the compression resistance is exceeded.

A similar procedure is also followed to avoid the resistance of individual rows exceeding that of the group as a whole due to overlapping effects from the individual rows, or to a change in the critical yield line pattern when the whole group is considered.

Finally when the resistance of a bolt row is likely to be limited by bolt fracture, an elastic distribution of bolt forces is assumed for the lower bolts, because in this case a plastic distribution cannot be relied upon.

## 6. Rotational stiffness

### 5.1 Basic model

Fig. 11(a) shows the spring model adopted for a composite joint with a steel end plate with one bolt row in tension. It is assumed that the deformations are proportional to the distance to the point of compression. The model is one developed for Eurocode 3 [6], and the stiffness coefficients  $k_1 - k_5$  and  $k_7$  for steelwork components are as defined in the revised Annex J. The stiffness coefficient  $k_{10}$  relates to the longitudinal reinforcing bars while  $k_{12}$  and  $k_{13}$  concern the stiffness of the column's encasement in shear and compression respectively (see below).

For a bolt row, the individual components that contribute to flexibility are replaced by a single spring of effective stiffness  $k_{eff}$ , as shown in Fig. 11(b). Finally the components in tension are then replaced by a single equivalent spring of stiffness  $k_{eq}$  acting at a lever arm  $z$  above the centre of compression (Fig. 11(c)).

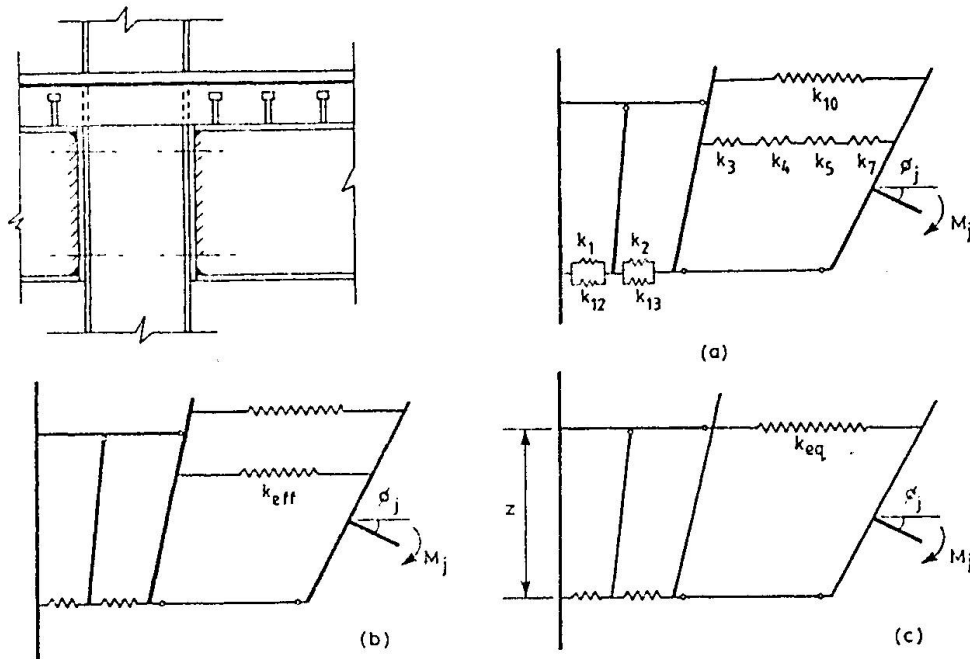

Fig. 11. Spring model for a composite joint with one bolt row in tension

When the column is encased, forces in this member are shared between the steel section and the encasement, leading to the parallel arrangement of springs shown for  $k_1$  and  $k_{12}$ , and for  $k_2$  and  $k_{13}$ , in Fig. 11(a). It follows that each of these pairs may be summed to determine the overall response (Fig. 11(b)).

The initial stiffness of the complete joint,  $S_{j,ini}$ , follows from analysis of Fig. 11(c), the resulting formula being identical to that given in the revised Annex J for Eurocode 3.

## 6.2 Longitudinal reinforcing bars in tension

Behaviour away from the joint is due to the actions of the structural members and therefore the reinforcement associated with the joint is assumed to extend only across the depth of the column section,  $h_c$  (Fig. 8). For a double-sided configuration (Fig. 6) under balanced moments, the tensile stiffness for each joint is therefore based on a length  $h/2$  of reinforcement. The stiffness coefficient  $k_{10}$  for use in the simplified nodal representation then follows by enhancing the stiffness by a transformation factor which compensates for the additional member flexibility introduced by the nodal representation [8, 11].

Under unbalanced loading, the flexibility of the joint results in a gap developing between the slab and the column face, but only on the more heavily loaded side. Parametric studies based on the spring model of Fig. 5 have led by curve fitting to a formula for a re-direction factor which depends only on the ratio of the moments each side of the column. This factor modifies the stiffness calculated for balanced loading.

## 6.3 Contact plate

This introduces a concentrated compressive force into the column web, leading to a reduced stiffness in comparison with the corresponding stiffness factor for the web given in Eurocode 3 [4].



#### 6.4 Encasement to the column web panel in shear

To develop a simple formula, use has been made of curve-fitting, based on a parametric study from the spring model of Fig. 5 [9].

#### 6.5 Encasement to the column web in compression

The stiffness is influenced by whether the load is introduced into the column via a contact plate, or in a more distributed manner through an end plate. This difference is accounted for by factors derived to represent the average behaviour revealed by parametric studies.

#### 6.6 Deformation of the shear connection

It is recognised from experimental and analytical studies [12] that interface slip between the concrete slab and the beam's steel section may affect substantially the rotational behaviour of a composite joint (Fig. 12). Thus unless such slip is accounted for by partial-interaction analysis of the beam (unlikely in practice), account needs to be taken of this effect by including it within the design stiffness of the joint. This is done by evaluating the stiffness of the shear connection  $K_{sc}$  in the hogging moment region of the beam [13] and then reducing the effective stiffness coefficient  $k_{10}$  for the reinforcement in tension.

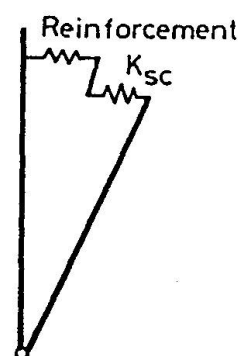

Fig. 12. Slip deformation

### 7. Rotation capacity

Ductility is needed if inelastic methods are used for global analysis. With partial-strength joints some components must therefore yield in a controlled way, without others failing prematurely which would curtail the capacity.

It is apparent from tests that the use of only common welded mesh as slab reinforcement results in brittle behaviour. In contrast the use of substantial reinforcement can lead to joints of high ductility. The tensile force in the reinforcement may cause significant slip in the shear connection and buckling deformations in the beam's lower flange, both of which contribute to rotation capacity.

For composite joints, the design moment resistance is calculated assuming that the slab reinforcement must yield. A minimum elongation can therefore be predicted from the ductility properties specified for the reinforcement. In addition, the deformation of the shear connection can be predicted [12], and an allowance may also be made for localised plastic deformation in the lower part of the beam's steel section.

The determination of the required rotation capacity is outside the scope of this paper, but as an indication up to around 30 mrad may be required in some practical situations [1]. Tests show that such a level of rotation can be supplied, but the ductility of the reinforcement used was significantly better than the minimum specified for even 'high ductility' bars [14]. Methods



based on a component approach are therefore being developed, so that designers can relate rotation capacity to their choice of material specification.

## 8. Conclusion

Substantial moment resistance and rotational stiffness can be achieved with simple steel connections by utilising the tensile action of slab reinforcement in a composite joint. The annex for design of such joints proposed for EN1994-1-1 will enable the benefits of continuity to be obtained in composite beams, along with the other well-known advantages of composite construction. By developing calculation procedures which will be accepted by many European countries, it is intended that this approach will be adopted as common practice.

## 9. References

- [1] LAWSON R.M., GIBBONS C. : *Moment Connections in Composite Construction : Interim Guidance for End-plate Connections*. Steel Construction Institute, Ascot, 1995.
- [2] *Eurocode 4 : Part 1.1 : Design of Composite Steel and Concrete Structures : General Rules and Rules for Buildings*. ENV 1994-1-1, CEN, Brussels, 1992.
- [3] *Eurocode 3 : Part 1.1 : Design of Steel Structures : General Rules and Rules for Buildings*. ENV 1993-1-1, CEN, Brussels, 1992.
- [4] *Eurocode 3 : Part 1.1 : Revised Annex J : Joints in Building Frames*. CEN, Brussels, to be published.
- [5] ANDERSON D. : Eurocode 4 and the Design of Composite Joints. Third International Workshop on Connections in Steel Structures, University of Trento, May 1995.
- [6] JASPART J.-P. : Design of steel connections according to ENV 1993-1-1, Annex J. IABSE 15th Congress, Copenhagen, June 1996.
- [7] TSCHEMMERNEGG F., BRUGGER R., HITTEBERGER R., WIESHOLZER J., HUTER M., SCHAUR B.C., BADRAN M.Z. : Nachgiebigkeit von Verbundkonstruktionen. *Stahlbau*, Vol. 63, No. 12, 1994 and Vol. 64, No. 1, 1995.
- [8] TSCHEMMERNEGG F., HUBER G. : Joint transformation and the influence for global analysis. Paper T6, COST-C1/ECCS TC11 Drafting Group for Composite Connections, University of Innsbruck, 1995.
- [9] TSCHEMMERNEGG F., HUBER G. : Shear region in the panel zone of a composite joint. Paper T3, COST-C1/ECCS TC11 Drafting Group for Composite Connections, University of Innsbruck, 1995.
- [10] TSCHEMMERNEGG F., HUBER G. : Compression region in the panel zone of a composite joint. Paper T2, COST-C1/ECCS TC11 Drafting Group for Composite Connections, University of Innsbruck, 1995.



- [11] TSCHEMMERNEGG F., HUBER G., PAVLOV: Tension region in the panel zone of a composite joint. Paper T4, COST-C1/ECCS TC11 Drafting Group for Composite Connections, University of Innsbruck, 1995.
- [12] ARIBERT J.-M. : Influence of slip of the shear connection on composite joint behaviour. Third International Workshop on Connections in Steel Structures, University of Trento, May 1995.
- [13] ARIBERT J.-M. : Proposed clause J.4.5 in Annex J for EN 1994-1-1. Paper AR11, INSA, Rennes, 1995.
- [14] *Eurocode 2 : Part 1 : Design of Concrete Structures: General Rules and Rules for Buildings.* ENV 1992-1-1, CEN, Brussels, 1992.