

Stress measurement and repair of a fatigue cracked box girder bridge

Autor(en): **Yamada, Kentaro / Ojio, Tatsuya / Kainuma, Shigenobu**

Objekttyp: **Article**

Zeitschrift: **IABSE reports = Rapports AIPC = IVBH Berichte**

Band (Jahr): **76 (1997)**

PDF erstellt am: **23.07.2024**

Persistenter Link: <https://doi.org/10.5169/seals-57469>

Nutzungsbedingungen

Die ETH-Bibliothek ist Anbieterin der digitalisierten Zeitschriften. Sie besitzt keine Urheberrechte an den Inhalten der Zeitschriften. Die Rechte liegen in der Regel bei den Herausgebern.

Die auf der Plattform e-periodica veröffentlichten Dokumente stehen für nicht-kommerzielle Zwecke in Lehre und Forschung sowie für die private Nutzung frei zur Verfügung. Einzelne Dateien oder Ausdrucke aus diesem Angebot können zusammen mit diesen Nutzungsbedingungen und den korrekten Herkunftsbezeichnungen weitergegeben werden.

Das Veröffentlichen von Bildern in Print- und Online-Publikationen ist nur mit vorheriger Genehmigung der Rechteinhaber erlaubt. Die systematische Speicherung von Teilen des elektronischen Angebots auf anderen Servern bedarf ebenfalls des schriftlichen Einverständnisses der Rechteinhaber.

Haftungsausschluss

Alle Angaben erfolgen ohne Gewähr für Vollständigkeit oder Richtigkeit. Es wird keine Haftung übernommen für Schäden durch die Verwendung von Informationen aus diesem Online-Angebot oder durch das Fehlen von Informationen. Dies gilt auch für Inhalte Dritter, die über dieses Angebot zugänglich sind.

Stress Measurement and Repair of a Fatigue Cracked Box Girder Bridge

Kentaro YAMADA
Professor
Dept. of Civil Eng.
Nagoya University
Nagoya, Japan

Tatsuya OJIO
Graduate Student
Dept. of Civil Eng.
Nagoya University
Nagoya, Japan

Shigenobu KAINUMA
Research Associate
Dept. of Civil Eng.
Nagoya University
Nagoya, Japan

Toshiyuki OBATA
Chief Engineer
Nat. Highway Office
Min. of Construction
Nagoya, Japan

Summary

A three span continuous box girder bridge in Nagoya was subjected to very heavy traffic, amounting to over 55,000 vehicles per day on three lanes and with about 50 percent trucks. In 1988 fatigue cracks were observed at diaphragm corners after 20 years of service. The fatigue damaged diaphragm corners were repaired by high strength bolted splices. Truss members were also added to stiffen the diaphragms and the cross beams. In the summer and the fall of 1996 stress measurements were carried out to investigate a method for measuring truck axle weights and to carry out a fatigue assessment of the orthotropic steel decks and diaphragm corners. In this paper the case history of the box girder bridge is summarized and the preliminary results of stress measurement are presented.

1. Introduction

Severe deterioration in highway bridges, such as deterioration in concrete decks and fatigue cracks in steel members, became noticeable to bridge engineers in the 1980s. This led to various research projects on repairing and retrofitting of aged and deteriorated highway bridges in Japan. Various case studies were carried out when severe deterioration was found in particular bridges.

This paper describes a case history of a three span continuous box girder bridge which exhibited fatigue cracks at diaphragm corners in 1988. The bridge was subjected to some of the heaviest loads in Japan. The stress measurement described here was carried out in 1996 as a part of the investigation to re-evaluate the effectiveness of the past rehabilitation measures, and to estimate wheel loads of trucks in service, which is essential for fatigue assessment of the bridge. The estimation of the wheel loads was carried out using the measured stresses at longitudinal ribs in the orthotropic steel deck.

2. Bridge description

2.1 History of the bridge

The three span continuous box girder bridge was constructed in 1964 with spans of 77 m, 96 m and 77 m. It is situated near a large port, and is subjected to very heavy traffic, since only a few alternative routes are available nearby. The bridge carries 3 traffic lanes in each direction on its orthotropic steel deck, as shown in Figure 1. Average daily traffic was about 55,000 in one direction in 1994, and about 43 percent of vehicles were trucks. Some of these were believed to be overloaded.

After about 25 years in service, fatigue cracks were found at corners of diaphragms and at sole plates of supports. A committee (Chairman; Prof. Nishino) was formed to investigate the extent of the damage, causes of the cracks and ways to retrofit the bridge. Intensive investigations, such as stress and vibration measurements and structural analysis by the finite element method, were carried out to find the best possible ways to retrofit the bridge. Based on such investigations the cracked parts were strengthened by high strength bolted splices, and truss members were added

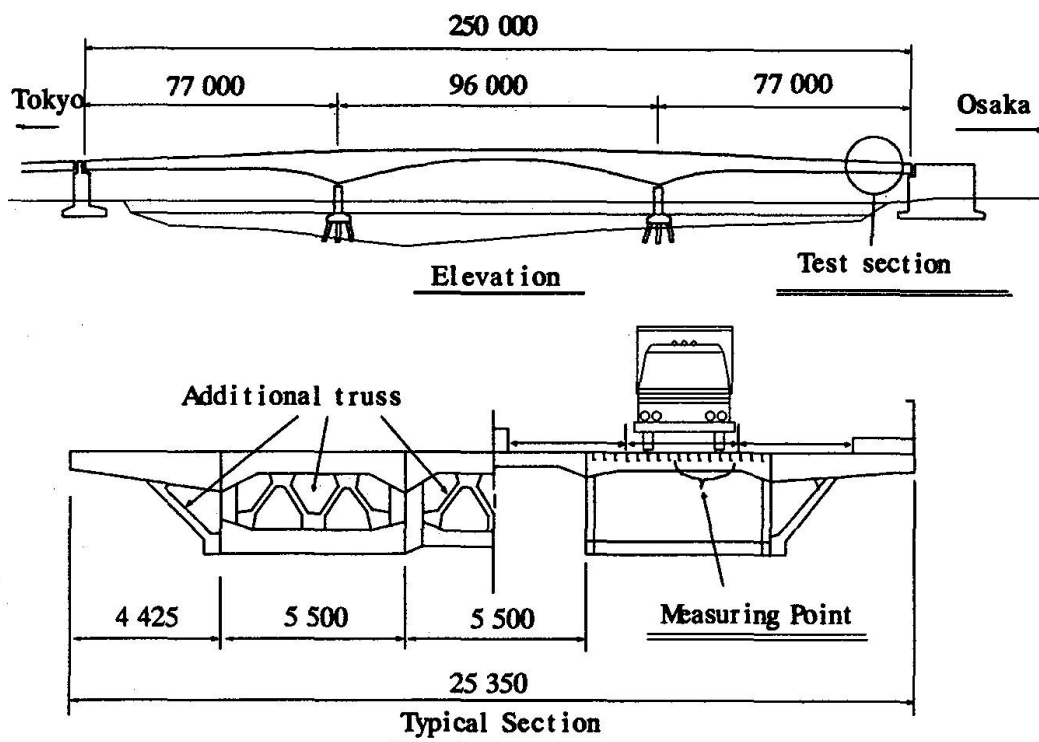

Fig. 1 Orthotropic steel deck bridge

to stiffen all diaphragms and every other cross ribs. The rehabilitation scheme seemed successful, and no further fatigue damages was observed at these stiffened parts. However, recent inspection revealed that a few additional cracks were found at the diaphragm corners which were not retrofitted eight years ago, because no fatigue cracks were observed at that time.

A study group (Chairman; Prof. Yamada) was formed to evaluate the effectiveness of the previous retrofitting, ways to retrofit the additional cracks, and overall resistance of the bridge against fatigue. The work is still underway. The stress measurements and estimation of the wheel loads described here is the part of the investigation.

2.2 Orthotropic steel deck with open ribs

The orthotropic steel deck of the box girder bridge is schematically shown in Figure 2. It has a 12 mm thick deck plate, stiffened longitudinally at every 300 mm with bulb plates (open ribs) of 180 mm wide and 9.5 mm thick. About 80 mm thick asphalt pavement is placed over the deck plate. Diaphragms are placed at every 7.7 m with four cross beams of which are 1.54 m apart between the diaphragms. As mentioned previously, the truss members were added to all diaphragms and every other cross ribs in order to stiffen them in 1988/89 retrofitting.

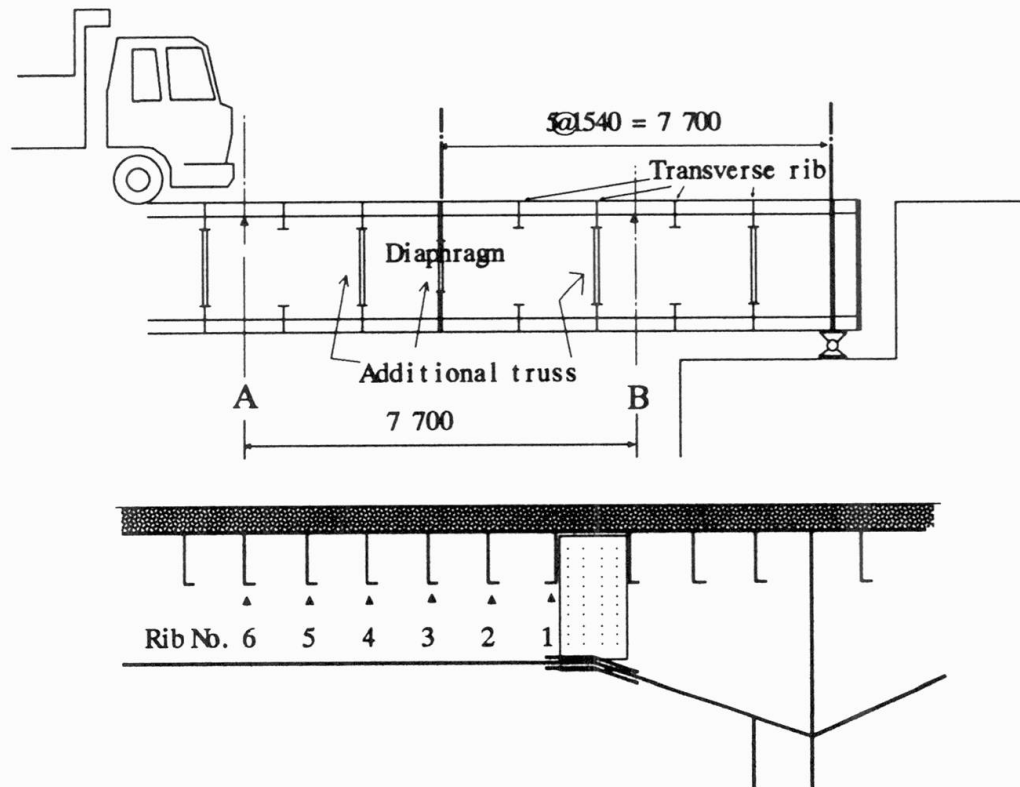

Fig. 2 Orthotropic steel deck of test bridge

3. Estimation of wheel loads

3.1 Procedure of wheel load estimation

Since the open ribs of the orthotropic steel deck are rather flexible, strain recordings measured at the open ribs can be used to estimate the wheel loads passing on them

The procedure used in this investigation is as follows;

- FEM analysis** : The finite element analysis was carried out for the orthotropic steel deck of interest to determine influence surfaces for all locations of strain gages, that were placed at the mid-span of the longitudinal ribs.
- Effect of tire loading** : Wheels with single tire and double tires with an unit weight were placed at different positions to calculate stress waves of the longitudinal ribs. Loading areas of the tires were determined according to JRA Specifications. Through such analysis it was determined to use six strain gages at two sections, A and B, near the supports, which were 7.7 m apart, as shown in Figure 2.
- Strain measurements** : Strain histories were recorded dynamically using Digital Data Recorder, and the data was transferred to a personal computer for further analyses. Typical strain recordings for 2-axle truck and 3-axle truck are shown in Figure 3.

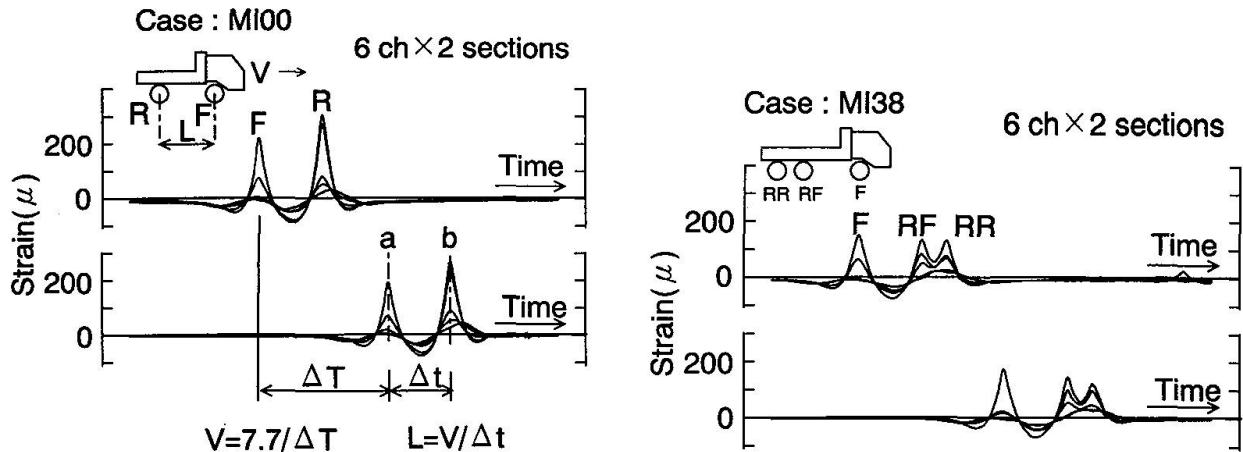

Fig. 3 Strain histories due to running of test trucks

d) **Tire types and their positions** : From six strain recordings peak strains corresponding to wheels passing on the mid-span of the ribs were determined first. Then, three largest strain recordings were picked up, and tire position was determined. Single or double tires was also clarified from the shape of the strain waves, as shown in Figure 4.

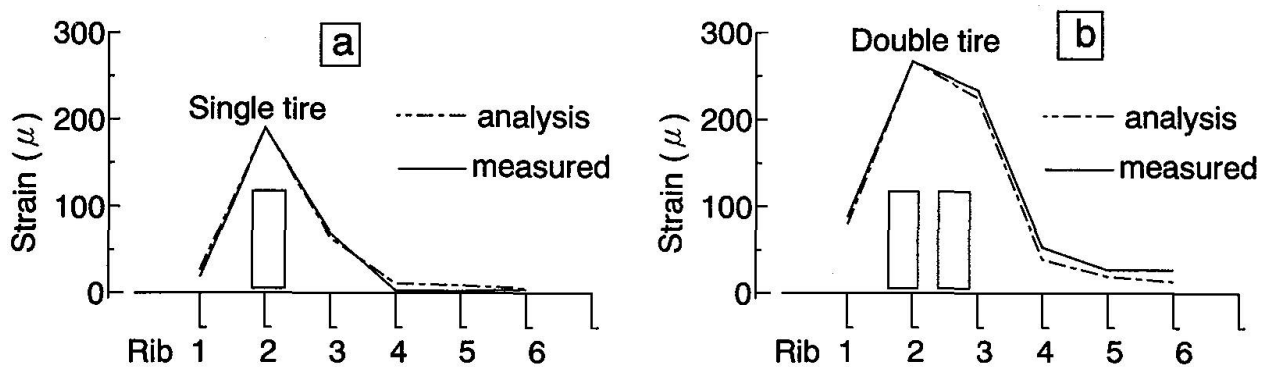

Fig. 4 Stress distribution of six ribs at a and b

e) **Wheel weight and number of axles** : The weight of each wheel was determined by comparing measured strains with the computed strains for an unit wheel load. Number of axles of each truck was also determined by checking distance between the wheels. These process was carried out in a personal computer, and they are visually monitored through CRT screen.

f) The velocity of the trucks was also determined from the time needed for the front wheel to pass the two test sections.

3.2 Stress Measurements

Stress measurements were carried out in the summer (July) and in the fall (October) of 1996. Strain gages to measure wheel loads were attached at the lower edge of six longitudinal ribs at two sections, A and B. Two test trucks were used in the summer experiments for calibration of this procedure. Dynamic strain were recorded digitally for 10 seconds for the summer experiments, when the test trucks passed on the test sections. About 45 trucks of various types were also measured. Accidentally, some other trucks were also recorded in the 10 second recordings, and total of 430 axles were recorded.

For the fall experiment strain recordings were automatically recorded for 2.5 seconds, whenever any strain in the section A exceeded 50 micro-strains. The measurement was carried out for 30 minutes in ever hour for 24 hours. About 200 trucks were monitored in this way in 30 minutes. The data was then transferred to an personal computer, which needed for 15 to 20 minutes. About 5,000 trucks were recorded for 12-hour recording.

4 Summer experiment (July 1996)

4.1 Measurement for test trucks

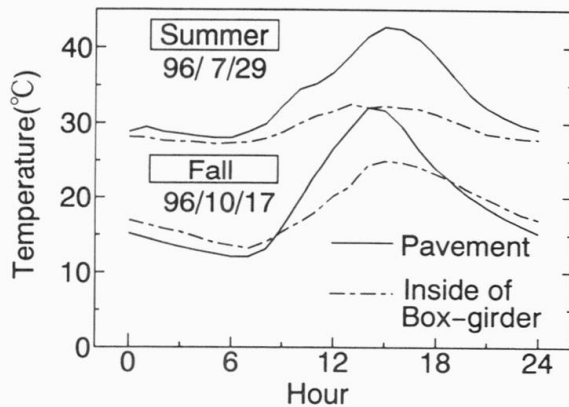

The first measurement was carried out in the end of July, 1996. It was the mid-summer in Nagoya and the temperature at the bottom of the asphalt pavement of the orthotropic deck was between 27 and 49, as shown in Figure 5. Two test trucks were used, as shown in Table 1. They were a 2-axle dump truck of 220 kN gross vehicle weight (GVW), and a 3-axle dump truck of 223 kN GVW. Drivers of the test trucks were asked to drive the trucks intentionally in the left, the center and the right sides of the mid-lane at different velocity. The test trucks ran with speed between 22 and 58 km/h over the test sections.

Fig. 5 Temperature of asphalt pavement



Type				
	F	RF RR	F	R
	Wheel load (kN)			
	F	RF RR	F	R
96' Summer	27.8	43.7 39.4	35.0	74.6
	GVW=223 kN		GVW=220 kN	
96' Fall	25.9	39.9 33.8	/	
	GVW=199 kN			

Table 1 Wheel loads of test trucks

From the recorded strains the wheel loads were estimated. The estimated wheel loads, W_e , are plotted against actual wheel loads, W_a , measured statically at a weigh station in Figure 6. It was found that W_e for the front and rear wheels were about 20 percent higher in average than W_a . The scatter of the estimated wheel loads was also observed owing to the scatter in the measured strain recording, which probably came from the vibration of the truck during the passage over the test sections.

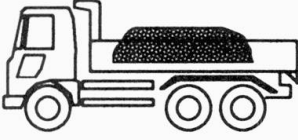
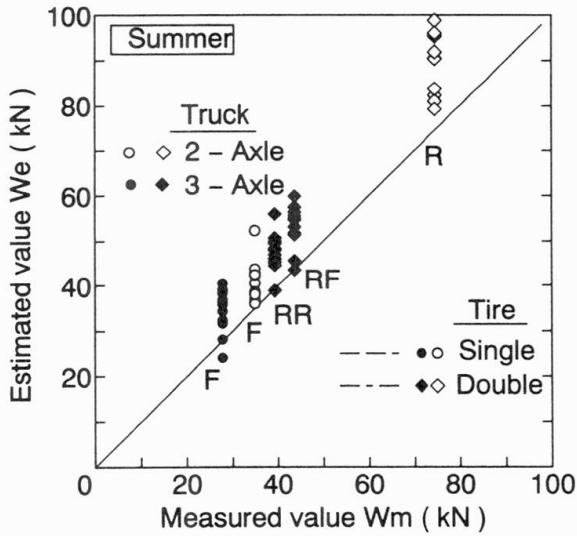

Fig. 6 Comparison of measured and estimated wheel loads of test trucks

4.2 Measurement for trucks in service

The wheel loads of the passing trucks of various types were also estimated. The result is plotted in Figure 7. The wheel loads of these trucks were not known, but the estimated wheel loads for the front wheel (single tire) are ranging from 4.9 kN to 64 kN. The maximum wheel loads showed scatter from 4.9 kN to 98 kN. The legal limit of the wheel loads was 49 kN in Japan. From the measured strain the wheel positions were also determined through the analysis and plotted in Figure 8. For 312 wheel loads heavier than 4.9kN the wheel positions were between the ribs 1 and 5, which were 1.2 m apart. The majority of the wheels passed between the ribs 2 and 3.

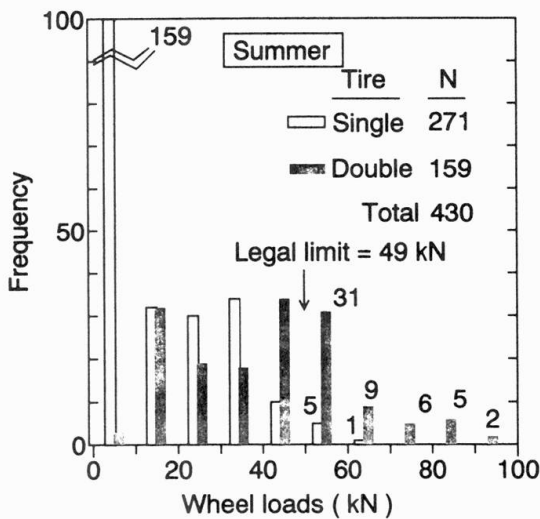

Fig. 7 Frequency of estimated wheel load position

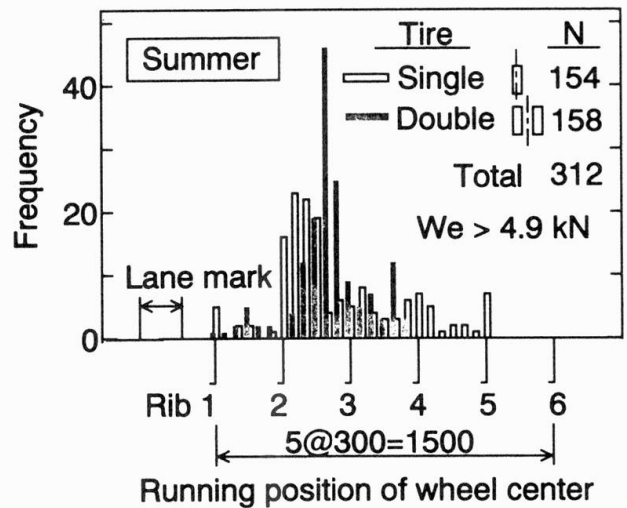

Fig. 8 Frequency of estimated wheel

5 Fall experiment (October 1996)

5.1 Measurement for test truck

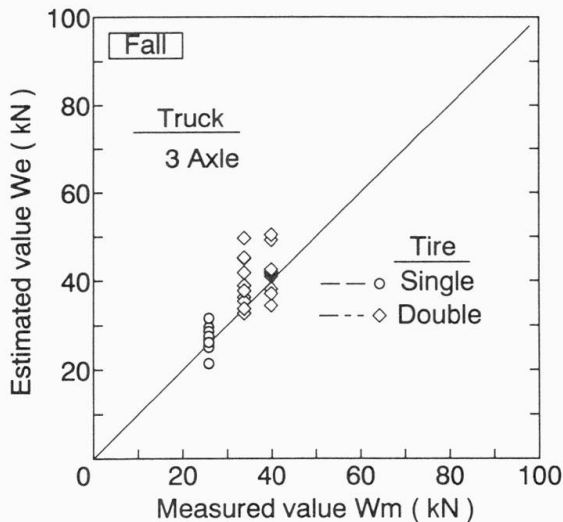

Fig. 9 The comparison of measured and estimates wheel loads of test trucks

The measurement was once more carried out in the mid-October, 1996, when the temperature of the asphalt pavement was ranging between 12 and 32, as shown in Figure 5. A 3-axle truck of 199 kN, which ran over the test sections 12 times, was used to calibrate the results. The wheel loads of the test trucks were estimated using the same technique used in the summer experiments. The results are plotted in Figure 9. The average estimated wheel loads were about 5 percent more than the actual wheel loads

The difference in the ratio of the average estimated wheel loads to the statically measured ones between the summer and the fall experiments was about 15 points. In this period supports near the section B was temporarily jacked up for replacement works from metal shoes to rubber ones. The effect of such change in structural details on the test results is unknown at this moment. The increase in the stiffness of the asphalt pavement above the orthotropic deck may also attribute to the

difference. The temperature of the asphalt pavement dropped by about 15 when the fall experiment was carried out. Increase in the stiffness of the asphalt pavement results less strain in the longitudinal ribs, and hence less estimated wheel load than that of the summer experiment.

5.2 24-hour measurement for trucks in service

The most of the recorded strain waves were automatically analyzed by a personal computers. About 10 percent of recorded strain waves were analyzed by inputting velocity of the trucks, since it was not computed automatically in the wave analysis. About 13,000 wheel loads were estimated for total 12 hours recordings.

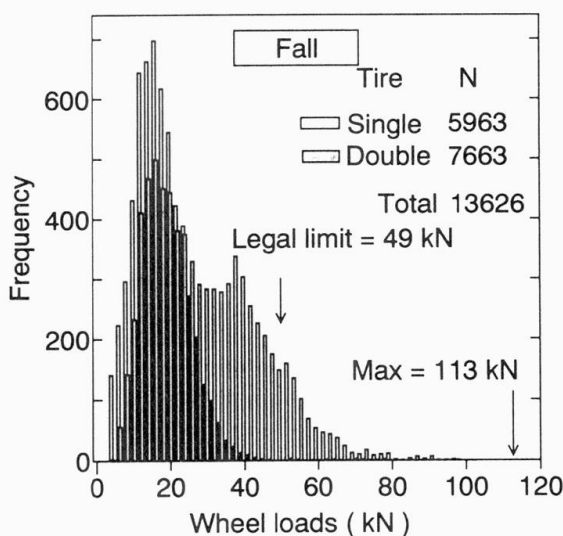

Fig. 10 Frequency of estimated wheel load

The estimated wheel loads, W_e , are summarized in Figure 10. Note that these wheel loads are for the trucks in which one of the strain recordings exceeded the trigger level of 50 micro-strain. The maximum wheel load observed during the 12-hr measurement was 113 kN. The frequency distribution of wheels with double tires shows two peaks, one around 39 kN, and the other at about 15 kN. The latter seemed the wheel loads when the truck were not loaded.

The running position of all wheels are plotted in Figure 11. The majority of the wheels passed between ribs 2 and 3, and some passed between ribs 3 and 4. In these areas ruts were observed, and the trucks seemed to run along such ruts.

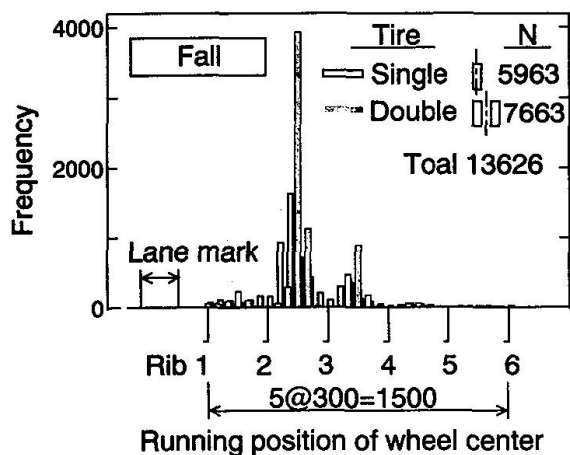

Fig. 11 Frequency of estimated wheel position

The velocity of each truck in service was also computed. The distribution of the velocity is plotted in Figure 12. The average speed was about 57 km/h. Approximately 50 percent of the trucks ran with speeds over 60 km/h, while speed limit of this road was 60 km/h.

Once the speed of each truck was known, one can compute the wheel spacing. The distribution of the computed wheel spacing is shown in Figure 13. There are several groups of wheel spacing. Compared with the configuration of the trucks currently used in Japan, the wheel spacing seems to correspond to (a) tandem wheels (about 1.3 m), (b) main spacing of dump trucks or tractors, (c) main spacing of 3-axle trucks or short trailer trucks, and (d) main spacing of long trailer trucks.

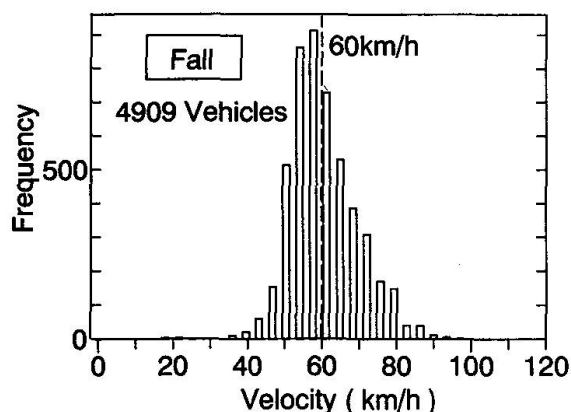

Fig.12 Frequency of vehicle velocity

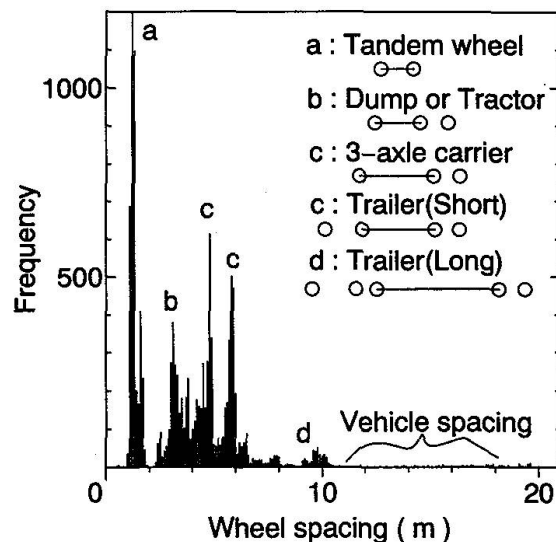

Fig.13 Frequency of estimated wheel spacing

6 Summary of findings

Some fatigue damages were observed in 1988 in a three span continuous box girder bridge situating in the heavily loaded highway . They were retrofitted by applying high strength bolted splices to the cracked parts, and adding truss members in diaphragms and cross ribs to stiffen the box section. The study is currently underway to investigate the overall durability of the bridge against fatigue. The stress measurements and the estimation of wheel loads described here were one part of the investigation. The followings summarize the findings of the stress measurement and the estimation of the wheel loads using the strain history recorded dynamically in the longitudinal ribs of the orthotropic steel deck.

1) The procedure used in this study to estimate the wheel loads in service seems feasible.

Relatively consistent values of estimated wheel loads were obtained for the wheel loads of the test trucks, of which the weight was measured statically at the weigh station.

2) The effect of the temperature of the asphalt pavement on the deck plate affect the estimated wheel loads of the test trucks. In the summer experiments the estimated wheel loads were about 20 percent higher in average than the measured ones. In the fall experiment the estimated value was about 5 percent higher for all wheels. It was about 15 points less than the summer

experiment. The lower temperature may cause higher stiffness of the asphalt pavement, and hence less strains in the longitudinal ribs, which lead to less estimated wheel loads.

3) The position of wheels, the speed of vehicles and wheel spacing of trucks can be also computed from the strain recordings. The data may be used to define the type of trucks in service.

4) The digital dynamic recorder used in this study enable us to record the dynamic strain waves for 2.5 seconds, whenever the strain exceeded a certain value. It was possible to record strain wave for about 200 trucks in 30 minutes. The measurement was carried out automatically for 24 hours. This procedure opened a way to record strains only when the heavier wheel loads passed on the test section.

Acknowledgments

The authors are grateful to those who helped us in the summer and the fall experiments. They are those from No.3 Work Office of Nagoya Highway Work Office, the Ministry of Construction, those from Toyo Giken Consultants, especially Messrs. Shindo and Furuichi, those from Dept. of Civil Engineering, Nagoya University, and from Tokyo Sokki Kenkyujo.

References

1. MATSUI, S. and EL-HAKIM, A., Estimation of Axle Loads of Vehicles by Crack Opening of RC Slab, *Journal of Structural Engineering, JSCE*, 1989, pp.407-418. (In Japanese)
2. MOSES, F., Weigh-In-Motion System Using Instrumented Bridges, *Transportation Engineering, Proceedings of ASCE*, Vol.105, No. TE3, May 1979.
3. Hanshin Expressway, Committee on Hanshin Expressway Design Loads, Study on Design Loads of Hanshin Expressway, Technical Report, 1986. (In Japanese)
4. MIKI, C., MURAKOSHI, J., YONEDA, T. and YOSHIMURA, Y., Measurement of Vehicle Weight in Service, *Bridge and Foundation Engineering*, April 1987, pp.41-45. (In Japanese)

Leere Seite
Blank page
Page vide