

Zeitschrift: IABSE reports = Rapports AIPC = IVBH Berichte
Band: 81 (1999)

Rubrik: Session A: Design

Nutzungsbedingungen

Die ETH-Bibliothek ist die Anbieterin der digitalisierten Zeitschriften. Sie besitzt keine Urheberrechte an den Zeitschriften und ist nicht verantwortlich für deren Inhalte. Die Rechte liegen in der Regel bei den Herausgebern beziehungsweise den externen Rechteinhabern. [Siehe Rechtliche Hinweise.](#)

Conditions d'utilisation

L'ETH Library est le fournisseur des revues numérisées. Elle ne détient aucun droit d'auteur sur les revues et n'est pas responsable de leur contenu. En règle générale, les droits sont détenus par les éditeurs ou les détenteurs de droits externes. [Voir Informations légales.](#)

Terms of use

The ETH Library is the provider of the digitised journals. It does not own any copyrights to the journals and is not responsible for their content. The rights usually lie with the publishers or the external rights holders. [See Legal notice.](#)

Download PDF: 06.10.2024

ETH-Bibliothek Zürich, E-Periodica, <https://www.e-periodica.ch>



Concrete Model Code for Asia : Design

Tamon UEDA
Associate Professor
Division of Structural &
Geotechnical Engineering
Hokkaido University
Sapporo, Japan

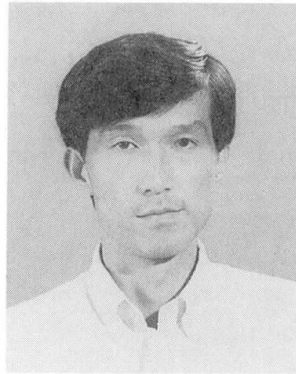

Tamon Ueda, born 1954, received his Doctor of Engineering degree from the University of Tokyo in 1982. Taught at AIT from 1987 to 1990. Currently the Coordinator, Design WG of International Committee on Concrete Model Code.

Summary

The design part of the Asian Concrete Model Code is briefly introduced. The design part is based on the performance based design concept, which is a new generation of the design method for the 21st century. The design part consists of the Level 1, Level 2 and Level 3 documents. The Level 1 and Level 2 documents can be commonly applied to any structure and to any region. The Level 3 document is prepared in accordance with the Level 1 and Level 2 documents and provides the complete design process for particular structure or region.

1. Introduction

The Asian Concrete Model Code (ACMC) was first published in January 1998¹⁾. ACMC contains three parts, namely Part I Design, Part II Materials and Construction and Part III Maintenance. This paper introduces the new concept and the main contents in Part I Design.

2. Outline of Design Part

2.1 Performance Based Design

The design part is drafted with the performance based design concept. The performance based design concept is the concept that clearly describes the required performance of the structure being designed. In ACMC the required performance is classified into the following three categories:

- Serviceability
- Restorability (or reparability)
- Safety

Serviceability is the ability of a structure or structural element to provide adequate services or functionality in use and not to cause unpleasant environment under the effects of considered

actions. *Restorability* is the ability of a structure or structural element to be repaired physically and economically when damaged under the effects of considered actions. *Safety*, which is the most important performance, is then the ability of a structure or structural element to ensure no harm would come to the users and to people in the vicinity of the structure under any actions.

The concept of the limit state design is similar to that of the performance based design. The difference is that the former describes the limit state with rather engineering terms while the latter describes the required performance with rather non-engineering terms, which can be understood easily by the users and the society. For example, the crack limit state, which is a typical limit state, indicates allowable crack width. We, engineers, can understand the meaning of the allowable crack width, however the user, non-engineers, may not understand its meaning fully. In the performance based design serviceability is clearly described first. One of items listed under serviceability is aesthetics of a structure. The width and length of a crack are good indices to indicate whether the structure looks good or not. As a result, limits for crack width and length can be specified.

Each performance must be quantified by some index, so that its required level can be explicitly expressed. In ACMC the performance index, PI is introduced for quantification. The required level of the performance is called the “performance index required”, PI_R , while the index of the performance that a structure or structural element possesses is called the “performance index possessed”, PI_P . Each required performance is then examined by comparing PI_P with PI_R . Generally the performance index is chosen in such a way that the greater value of the performance index means the better performance. In this case the following formula should be satisfied.

$$PI_P > PI_R \quad (1)$$

A typical example of PI_P and PI_R is the bending strength of an element and the maximum bending moment acting on the element respectively. The bending strength should be greater than the maximum bending moment. Another example is that PI_P is the maximum crack width caused by actions and PI_R is the limit of crack width for aesthetics. In this example the maximum crack width should be less than the crack limit, i.e. $PI_P < PI_R$.

By using the performance index, not only the examination of the required performance but also the evaluation of the performance possessed by the structure can be conducted. The examination only tells you whether the structure satisfies the required performance or not. The evaluation, however, tells you how good the performance the structure possesses. ACMC includes this concept as well. As a simplified method, the ratio, PI_P / PI_R can be used for the evaluation.

2.2 Level 1, 2 and 3 Documents

Each Part of ACMC consists of Level 1, Level 2 and Level 3 documents as shown in Fig. 1. The Level 1 document in Part I Design describes the basic concepts, such as the performance based design concept as described earlier. The Level 2 document has four chapters as follows:

- Design for Actions in Normal Use

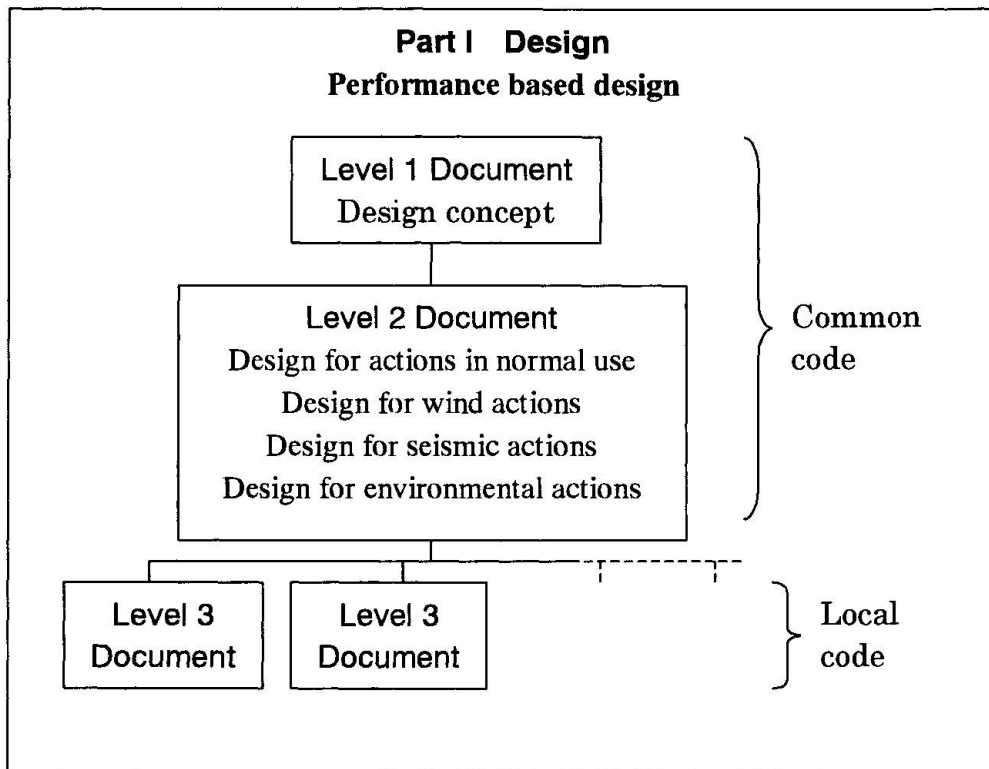

Fig. 1 Structure of Part I Design

- Design for Wind Actions
- Design for Seismic Actions
- Design for Environmental Actions

Four chapters are for different types of actions. Each chapter describes what kinds of performance should be examined and what are the performance indices. Even for the same performance the performance index may be different if the types of actions considered are different. Forces, such as axial force, bending moment, shear force and torsion are the performance indices for safety in the Design for Actions in Normal Use, while displacements are the performance index in the Design for Seismic Actions.

The Level 1 and Level 2 documents are codes for any types of structure in any region/country. However, there exist local conditions in each region and country, which may not be applied elsewhere. Some construction materials are not available due to economical and/or climatic reason. Also some types of structure and structural analysis may not be suitable due to economical reason and/or available technological level. The Level 3 document can consider all these local conditions. The contents in the Level 3 document should conform to those in the Level 1 and 2 documents, even though the details may be different. For this reason the Level 3 document is preferably prepared by the authority in each region and country. The Level 3 document can also solve the problem caused by the situation that there are variable codes for different types of structures, such as buildings and bridges. In a country like Japan and China the codes for buildings and for bridges are different. For example the design equations, such as that for shear strength are different. The design equation is the tool to calculate the performance index that only appears in the Level 3 document but not in the Level 1 and Level 2



documents. In this case preparation of both the Level 3 document for buildings and the Level 3 document for bridges is the solution.

3. Level 1 Document

The table of contents for the Level 1 document is as follows:

0. Notation
1. General
2. General Principles
3. Requirements
4. Materials
5. Actions
6. Analysis
7. Examination of Performance
8. Evaluation of Performance

Chapter 1 tells you that the scope of ACMC is all types of concrete structures as well as structural and nonstructural elements subjected to mechanical and environmental actions. It is described in Chapter 2 that structures should be designed, constructed and operated to maintain their performances in safety, economical restorability and serviceability. It goes on to say that in the design and construction of structures special considerations has to be made to protect the environment by avoiding any damage to the environment and by saving or recycling resources. Chapter 3 describes three required performances, serviceability, restorability and safety. Chapter 4 says that the material properties and models that are necessary for design analysis (or computation of the performance index) should be specified. The detailed specifications are provided in the Level 2 and Level 3 documents. Chapter 5 classifies actions into four groups, actions in normal use, wind actions, seismic actions and environmental actions. This classification is adopted in the Level 2 document. Chapter 6 suggests that a three-dimensional analysis with consideration of material and geometrical non-linearity and time effects is the best to be used. Simplified methods, such as one or two dimensional analysis, linear analysis and static analysis, which are used in most of the current practical cases, can be used with careful consideration of their accuracy. Chapters 7 and 8 explain how to examine and evaluate the required performance (see Sec. 2.1 of this paper for the details).

4. Level 2 Document

The Level 2 document contains 4 chapters for four different types of actions, namely (1) actions in normal use, (2) wind actions, (3) seismic actions and (4) environmental actions. Each chapter is for the case in which the corresponding actions are major actions and the effects of the other actions are negligible. For example in the chapters for other than environmental actions the effects of environmental actions are rather small because of moderate environment and/or because of the proper measure for protecting the structure.

The level 2 document provides all the items necessary for design. These items are common in



any region and for any type of structure. However, the detailed descriptions may be different for different regions and different structure types and are provided in the Level 3 document. For example, it is said in the Level 2 document that the stress-strain relationship of concrete must be provided. No specific stress-strain relationship, however, is provided in the Level 2 document, which is provided in the Level 3 document instead.

Each chapter has identical table of contents, which conforms with that of the Level 1 document, as follows:

- *.0 Notation
 - *.1 General
 - *.2 Requirements
 - *.3 Materials
 - *.4 Actions
 - *.5 Analysis
 - *.6 Examination of Performance
 - *.7 Evaluation of Performance
- (*: 1 to 4)

4.1 Design for Actions in Normal Use

Actions in normal use are classified into three categories:

- Permanent loads
- Variable loads
- Accidental loads

Fatigue loads, which are repetitive loads and cause fatigue phenomena such as strength reduction and stiffness reduction, are among variable loads. For each load the intensity, duration and frequency need to be specified.

Materials to be described are concrete, reinforcement and materials at the interface between concrete and reinforcement. Reinforcement may be steel and continuous fibers, while the materials at the interface are those for filler, grouting and shear connector. The material properties of concrete and reinforcement necessary for design analysis are strength (static and fatigue), stiffness, time-dependent properties (creep, relaxation and shrinkage) and thermal properties (thermal expansion and conductivity). Material models, such as stress-strain relationship, may be provided instead of material properties. The most appropriate stress-strain relationship is a three dimensional one with consideration of the effects of loading history, such as rate, duration and cycles of loading. The stress-strain relationship for concrete should consider the situation after cracking as well, so that the mechanism at crack surface can be treated appropriately. Simplified stress-strain relationships may be used provided that their applicability has been confirmed. Instead of providing separate models for concrete, reinforcement and the interfacial material, models for the composite material consisting of concrete, reinforcement and the interfacial material may be provided.

The required performances and corresponding indices needed to examine the required

performances are listed in Table 1.

Table 1 Required performances and performance indices

Required performances		Performance indices
Major items	Sub items	
Serviceability	Comfortable ride/walk	Acceleration, natural period, gap/step, pavement type
	Comfortable stay	Deformation
	Anti-vibration	Vibration level, natural period
	Anti-noise	Noise level, soundproof wall type
	Anti-odor	Substance density
	Anti-humidity	Humidity
	Aesthetics	Crack density, dirt density
	Shielding	Amount of substance/energy penetrating, crack width
	Permeability	Amount of substance/energy penetrating, porosity
Restorability		Axial force, bending moment, shear force, torsion, stress range
Safety		Axial force, bending moment, shear force, torsion, stress range

The required performances for serviceability are those to provide comfortable use of the structure, to avoid unpleasant environment around the structure and to keep necessary functions of the structure. Practically the performance indices for restorability and safety may be the same because the critical situations for restorability and safety are rather similar under the effects of actions in normal use. Generally the appropriate performance indices for both restorability and safety are either forces or stress ranges but not deformations/displacements.

Deformations/displacements are good indices for wind and seismic actions. Stress ranges as the performance index are for fatigue loading. Restorability here is the ability to limit structural damage in such a way that no repair work is necessary. Under the effects of actions in normal use the force, the performance index, beyond which repair works are required and the force at the ultimate stage are only slightly different. Therefore, it has practically no meaning to specify the performance index possessed, PI_p for the force beyond which repair works are impossible economically and technologically. Under the effects of seismic actions, however, the performance index corresponding with the repairable state is meaningful (see Sec.4.3).

4.2 Design for Wind Actions

The main feature of this chapter for the design for wind actions is the description for actions and analysis. The characteristics of wind actions, such as wind speed and wind pressure, depend on the type of structures because the importance and design life of the structures are different. Structures are divided to consider appropriate return periods as follows:

- Extremely important structures and components
- Regular structures (including tall buildings) and components
- Small-scale, light residences and stores and the like
- Temporary facilities



For wind pressure evaluation structures are classified as follows:

- Normal, bulky and relatively stiff structures
- Tall and slender or flexible structures
- Irregular structures

Acceptable analyses for wind pressure evaluation are

- Equivalent static approaches based on tabulated coefficients
- Dynamic approaches based on the natural frequency and geometry of the structures
- Wind tunnel tests

Provisions for materials and examination of performance are essentially the same as those in the design for actions in normal use. The only exception is that displacements of the structure, such as inter-story drift for buildings, can be a performance index for restorability.

4.3 Design for Seismic Actions

The provisions for this chapter are to ensure the formation of a planned yielding mechanism in the structure. For the structures in which the yielding mechanism may not occur other design approaches should be applied.

The following three levels of earthquakes are considered for seismic actions:

- *Minor-to-moderate earthquake:* Earthquakes which may occur a couple of times during the lifetime of the structure
- *Severe earthquake:* Earthquakes which may occur once during the lifetime of the structure
- *Ultimate earthquake:* Earthquakes which is the strongest feasible for the site

The return period and intensity of the above earthquakes are different depending on the lifetime of the structure and the importance of the structure. If the structure is important like a nuclear power plant, an ultimate earthquake that may not occur at the particular site but somewhere may be chosen as the ultimate earthquake.

Nonlinear pushover analysis should be used. Nonlinear dynamic analysis may be used additionally to improve the accuracy of the analytical results. With confirmation of the reasonable accuracy in the analytical results simplified methods, such as linear analysis and plastic limit analysis, may be applied instead of the nonlinear pushover analysis. Material properties and models necessary for the design are essentially the same as those for the design for actions in normal use.

The performance index for all the required performances (serviceability, restorability and safety) is displacements of the structure. The maximum response displacement, which is the performance index required, PI_R , for each performance is calculated by taking one of the three levels of the earthquake as seismic actions. Serviceability is to ensure that the function of the structure is maintained and that members planned to yield do not yield. Reparability that



ensures that members planned yield can be repaired economically and technologically is the basis to determine the performance index possessed, PI_p for restorability. It should also be ensured that members planned not to yield do not yield nor fail in shear. For safety PI_p should be chosen so that the significant loss of the load carrying capacity of the structure does not occur and that the integrity of the structure to support the loads acting after the earthquake event is maintained.

4.4 Design for Environmental Actions

The design for environmental actions is applied to the cases in which the effects of environmental actions are not negligible. In those cases the structure is designed for not only the environmental actions but also major actions to the structure, namely actions in normal use, wind actions or seismic actions.

Environmental actions that cause the material property change, usually the property deterioration, are as follows:

- Chloride ion penetration
- Carbonation
- Freezing and thawing
- Chemical attack
- Abrasion by cavitation and friction

Besides the material properties necessary for the design analysis under the effects of actions in normal use, wind actions and seismic actions (see Sec.4.1) there are other material properties necessary for the analysis of environmental effects. They are permeability, ion diffusibility and resistivities against chemical and physical attacks. The material properties, such as strength and stiffness are calculated with consideration of the environmental actions and the material properties for the environmental actions.

Durability grade is specified besides the required performances as shown in Fig. 2. Durability grade is the required durability level in the structure, which depends on the degree and frequency of remedial actions during the design service life, and is classified into the following three grades:

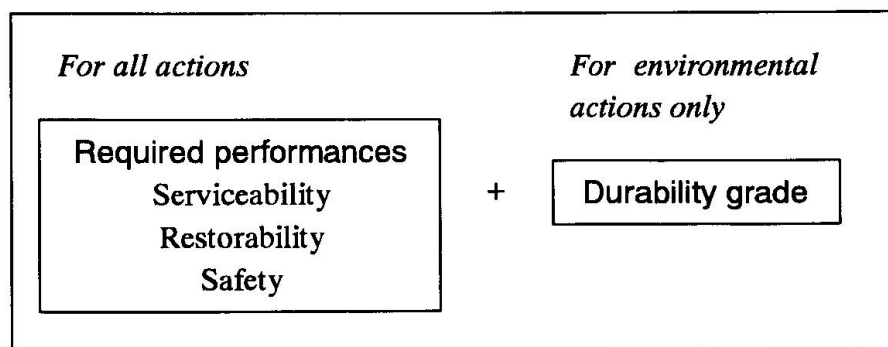

Fig. 2 Durability grade



- *Durability grade 1:* During the service life, the structure should maintain its required performances without any remedial actions
- *Durability grade 2:* During the service life, the structure should maintain its required performances with a couple of times of simple remedial actions
- *Durability grade 3:* During the service life, the structure should maintain its required performances with the regular remedial actions

The effects of environmental actions are considered in either of the following two ways:

- (1) The performance index under the effects of the other actions that are actions in normal use, wind actions and seismic actions is calculated with consideration of the effects of environmental actions. This performance index is called as long-term performance index, LPI . The required performance is examined by comparing the long-term performance index possessed LPI_P with the long-term performance index required, LPI_R . The bending strength of a section calculated with consideration of the material property deterioration is a LPI_P , while the maximum bending moment calculated with consideration of the material property deterioration is a LPI_R . The LPI_R depends on the durability grade. In the case of the bending moment, LPI_R for the durability grade 1 is greater than or equal to that for the durability grade 2, and that for the durability grade 2 is greater than or equal to that for the durability grade 3.
- (2) The required performance under the effects of actions other than environmental actions is examined according to the provisions in the design for the respective actions. And then the *deterioration index*, which is a kind of simplified performance index, is applied for the examination of the performance under the effects of environmental actions. The deterioration index possessed is compared with the deterioration index required. The deterioration index possessed is calculated as the material property deterioration. The deterioration index required depends on the durability grade. The deterioration index is provided for each type of deterioration as follows:
 - *Chloride induced reinforcement corrosion:* The depth from concrete surface, where the concentration of chloride ions has reached the critical value to depassivate the reinforcing steel, and the amount of reinforcement corrosion
 - *Carbonation:* The depth of carbonation and amount of reinforcement corrosion
 - *Frost damage:* The depth of concrete damaged by freezing and thawing
 - *Concrete corrosion due to chemical attack:* The damaged concrete area and depth, the loss in concrete strength, and the amount of reinforcement corrosion

For example, the depth from concrete surface, where the concentration of chloride ions has reached the critical value to depassivate the reinforcing steel is calculated as the deterioration index possessed. On the other hand the required depth for the critical value of the chloride ion concentration, which is the deterioration index required, is provided considering the durability grade. The required depths for the durability grade 1 is greater than or equal to that for the durability grade 2, which is greater than or equal to that for the durability grade 3.

5. Level 3 Document

Without the Level 3 document actual design for structures cannot be done. The Level 3 document contains the complete processes for the examination of each required performance, which are the necessary design equations and details. The Level 3 document acts like a design manual. It be prepared only for a particular type of structure or for a particular region/country. There can be many Level 3 documents.

The International Committee on Concrete Model Code (ICCMC) has been preparing some examples of the Level 3 documents as follows:

- Design for Actions in Normal Use based on a Japanese code²⁾
- Design for Actions in Normal Use based on the current Thai practice
- Design for Wind Actions based on the current Malaysian/Singaporean practice
- Design for Seismic Actions based on the current Thai practice
- Design for Actions in Normal Use (Punching Shear Strength in Reinforced and Post-tensioned Concrete Flat Plates with Spandrel Beams)

The first four are examples that are meant to be applied to a certain country(s), while the last example is only for examination of a particular required performance, safety, in which punching shear force is the performance index.

6. Conclusions

The design part of the Asian Concrete Model Code, Part 1 Design, is briefed in this paper. The main feature of Part 1 Design is as follows:

- (1) Part 1 Design is written with the performance based design concept, which clearly indicates the required performance. The required performance is classified into serviceability, restorability and safety.
- (2) Part 1 Design consists of the Level 1, Level 2 and Level 3 documents. The Level 1 document describes the main concept of design while the Level 2 document explains all the required performances with the corresponding performance index, which quantifies the performance for examination of the performances. The Level 3 document provides the complete examination processes of the required performance that are the design equations and details. The Level 1 and Level 2 documents are common to any structure and any region/country, however the Level 3 document may be applied to only particular structure and particular region/country.
- (3) The Level 2 document contains four chapters, which are for design for actions in normal use, wind actions, seismic actions and environmental actions.

Acknowledgement

Part I Design has been prepared by WG1 of ICCMC. The author would like to express his sincere gratitude to all the members of WG1, especially Prof Toshimi Kabeyasawa of the University of Tokyo, the former coordinator of WG1, who drafted Part I Design for the first time as well as Dr Tan Kiang Hwee of the National University of Singapore, Prof Manabu Yoshimura of Tokyo Metropolitan University and Dr Koji Takewaka of Kagoshima University who have



prepared Chapters 2, 3 and 4 in Level 2 documents.

Reference

- 1) International Committee on Concrete Model Code: Asian Concrete Model Code – First Draft, ICCMC, January 1998
- 2) Japan Society of Civil Engineers: Standard Specification for Design and Construction of Concrete Structures, JSCE, 1996 (in Japanese)





Experimental Study of Stress Evaluation of Unbonded Tendon under Ultimate Load

Jeong-Ho Moon
Professor, Ph.D
Department of Architectural Engineering
Hannam University, Taejon, Korea



Jeong-Ho Moon, born 1959.
He received his Ph.D degree from
University of Texas at Austin, USA.

Jae-Hyung Lim
Director, Ph.D
ALT Structural Research Group
Seoul, Korea



Jae-Hyung Lim, born 1963.
He received his Ph.D degree from
Hanyang University, Seoul, Korea.

Li-Hyung Lee
Director, Dr. Eng.
advanced STructure RESearch Station
Hanyang University, Seoul, Korea



Li-Hyung Lee, born 1941.
He is a professor of architectural
engineering at Hanyang University,
Seoul, Korea. He received his Dr. Eng.
degree from Tokyo University, Japan.

Summary

The present study describes an experimental study for the evaluation of the unbonded tendon stress in prestressed concrete member at flexural failure. A test program with fourteen beams and slabs was planned to identify the contribution of each important variable. The variables are effective prestress, concrete strength, amount of tendons, amount of bonded reinforcements, loading type, and span/depth ratio. It was found that the tendon stress increment decreases as the level of effective prestress or amount of unbonded tendon and bonded reinforcements increases. Also, the contributions of concrete strength, and loading type were observed to affect on the tendon stresses. However, the tendon stress increments of unbonded tendon were higher than the ACI Code equation at high values of span/depth.

1. Introduction

The behavior of the members with unbonded tendon is different from that of the members with bonded tendon. Equilibrium and compatibility equations can be applied to the members with bonded tendon assuming that the tendon and concrete behave as a body since they are bonded completely in the member with bonded tendon. In the members with unbonded tendon, however, the tendon and concrete behave independently except at the both ends of the member. Therefore, the analysis must be based on the global compatibility rather than on the local compatibility. The latter means that the tendon and concrete behave as a body in any section of the member. The former means that the overall elongation of the concrete equals to the total lengthening of the tendon at the location of the tendon.

Many researches have been carried out as to the members with unbonded tendon, on the basis of

which various design equations such as ACI code have been proposed so far. But it is hard to say that global compatibility is fully considered in the existing code equations which have been proposed or put into use. Furthermore, those design equations are based on the very limited parameters and experiments and they generalize the data derived from the limited parameters of one or two.

The previous study⁽¹⁾⁽²⁾ in relation to the present study have investigated the problems of ACI code equation and of the existing design equations, on the basis of which new design equation have been proposed. The proposed design equation has been verified with the existing experimental results and compared with the existing design equations. The present paper describes the experimental study which is also aimed to verify the validity of the proposed design equation.

2. Test program

The number of specimens was 14 and they were designed according to ACI 318-95. The parameters for the experiment were effective prestress, concrete strength, amount of tendon, amount of bonded reinforcement, span/depth ratio, and loading type.

The span of specimens was fixed to be 4.0m to comply with the laboratory condition. The cross section was a rectangle with 20cm by 30cm. However G-series specimens had width of 60cm and depth of 12, 15, 25cm. The specimen list was illustrated in Table 1 and the details of the representative specimen (A-1) in Fig. 1.

The tendon was low relaxation 3-wire strand. The tendon was manufactured as a mono-strand in which grease was inserted in the PE pipe in a factory. Its tensile strength was around 1860 MPa Grade, main reinforcements were 8 mm diameter and stirrups were 6 mm diameter. Concrete was mixed in batch plant of PC manufacturing factory. The maximum size of aggregate was 19 mm and the design strength was 30 MPa, 40 MPa, and 60 MPa.

Table 1 Specimen list

Specimen	Loading type	f_{se}	f'_c MPa	\square_p	\square_s	L/d _p
A-1	Uniform (4-point)	0.6 f_{pu}	23.4	0.00256	0.00242	17.5
B-1		0.7 f_{pu}	23.5			
B-2		0.5 f_{pu}	23.5			
C-1		38.4	0.00171			
C-2		52.9				
D-1		23.5	0.00256			
D-2		23.5				
E-1		23.5	0.00323			
E-2		23.5				
F-1		2-point	23.5			
F-2	1-point					
G-1	Uniform (4-point)	23.5	0.00146	0.00194	18	
G-2				0.00216	30	
G-3				0.00216	45	

* NOTE : Tendon profile = Straight

f_{pu} = 1860 MPa Grade

f_y = 420 MPa Grade

\square_6 = 0.1982cm² (3-wire mono-strand)

D8 = 0.50cm² (Deformed bar)

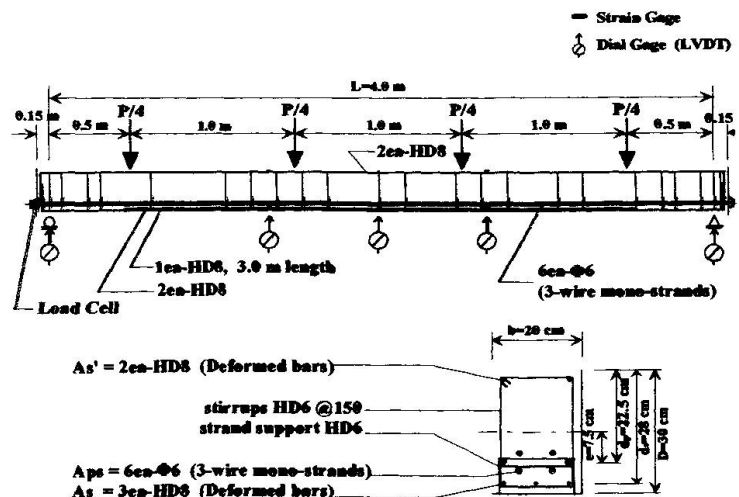

Fig. 1 Details of specimen (A-1)



3. Experimental results and investigations

3.1 Cracking and failure patterns

The specimens were designed following the ACI code requirement of $\square M_r > 1.2M_{cr}$ to ensure the ductile mode of failure.

As seen in Table 2, the specimens was considered to be appropriate since the ratio of maximum load to the cracking load was more than 2.0 as a whole. The vertical hair crack was initiated at the center where moment is maximum. Vertical flexural cracks

spread to the support in a regular interval on both sides with the gradual increase of the load to the yielding load. After the yield load, the flexural crack did not spread beyond the range which was assumed to be plastic hinge length and new cracks emerged between the existing cracks.

In the section of maximum flexural moment, the width of cracks got wider and the flexural crack proceeded to the extreme compressive concrete fiber. From this point to the right before the maximum load, the width of 1-3 cracks got wider than that of other cracks around. When the load reached the maximum, there happened a compressive failure in the center extreme compressive concrete. After the compressive failure of the extreme compressive concrete, the capacity decreased rapidly and the deflection increased rapidly.

The cracking patterns can be explained with the curvature distribution which is related with the

Table 2 Experimental results

Specimen	F_{se} (kN)	F_{ps} (kN)	$\square F_{ps}$ (kN)	P_{cr} (kN)	P_{max} (kN)	P_{max}/P_{cr}	\square_{max} (□)
A-1	22.25	32.93	10.68	57.33	124.66	2.17	73.8
B-1	25.77	34.79	9.02	55.86	118.58	2.12	72.8
B-2	18.82	32.14	13.32	44.59	114.17	2.56	90.2
C-1	21.85	33.42	11.57	56.84	119.27	2.09	74.8
C-2	22.15	35.67	13.52	61.74	131.03	2.12	97.6
D-1	22.25	35.87	13.62	40.18	95.55	2.37	97.4
D-2	22.15	32.14	9.99	59.78	138.77	2.32	69.2
E-1	22.15	32.83	10.68	52.92	120.05	2.26	74.0
E-2	21.95	28.81	6.86	55.86	132.69	2.37	48.8
F-1	22.05	33.04	10.99	40.18	78.92	1.96	97.4
F-2	22.05	31.75	9.70	27.44	55.27	2.01	71.8
G-1	22.05	36.95	14.90	100.9	228.44	2.26	122.4
G-2	22.05	32.63	10.58	34.01	66.05	1.94	118.4
G-3	22.05	32.34	10.29	15.78	31.07	1.96	166.6

F_{se} : Effective prestress/1ea P_{max} : Maximum load
 F_{ps} : Ultimate tendon stress/1ea P_{cr} : Initial cracking load
 $\square F_{ps}$: Tendon stress increase/1ea \square_{max} : Maximum deflection

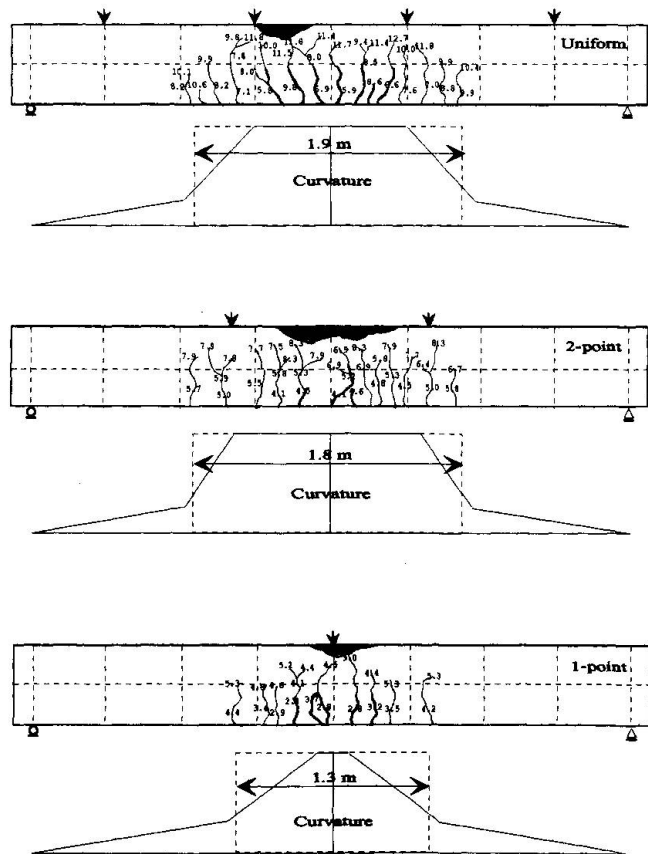

Fig. 2 Final failure pattern depending on type of applied load

type of applied load. Fig. 2 illustrates the final failure patterns of one of specimens. The plastic hinge lengths under 2-point load or uniform load (4-point load) were almost same since the ranges of the cracks under 2-point load or uniform load were 1.8m and 1.9m, respectively. In case of 1-point load, however, the range of cracking was 1.3m, which was smaller than the cases of 2-point load or uniform load.

3.2 Parametric effects

The unbonded tendon stress were computed with the prediction equations⁽²⁾⁽⁴⁾. The results were illustrated in Fig. 3 to 8. The meaning of the abbreviations used in the figures are as follows.

- Exp = The experimental results
- Compatibility⁽²⁾ = Strain compatibility method
- ACI⁽⁴⁾ = ACI 318-95 equation
- Design⁽²⁾ = design equation proposed by authors

The computed results by strain compatibility method were compared with experimental results. The design equation proposed by authors was also examined. Those tested and computed tendon stresses were also compared with the current ACI Code equation. Followings were the description the effect of each parameter.

(1) Effective prestress (f_{se})

Fig. 3 shows a comparison between the computed results and the experimental results for the tendon stress increases depending on the level of effective prestresses. As seen from the figure, the experimental results agree well with the computed results by the strain compatibility method. It means that the computational model of the strain compatibility method is accurate to evaluate the ultimate stress of unbonded tendon. The experimental results show that the tendon stress increases are decreasing as the level of effective prestress increases. But the current ACI Code equation predicted to remain constant regardless of the level of the effective prestresses. The ultimate stresses of the tendon were underestimated up to 68%-83% of the experimental values. The results by the design equation by authors was the same as in the tendency of the experiment results. As increases the effective prestress, the tendon stress at failure decreases. The ultimate stresses of the tendon (f_{ps}) turns out to be 77%-87% of the experimental values which provides better predictions compared with the current ACI Code equation.

(2) Concrete strength (f'_c)

Fig. 4 shows a comparison between the results of computation and experiment at variation of

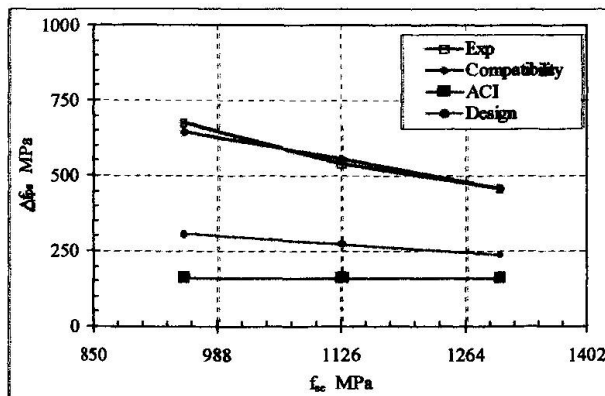

Fig. 3 Effect of effective prestress

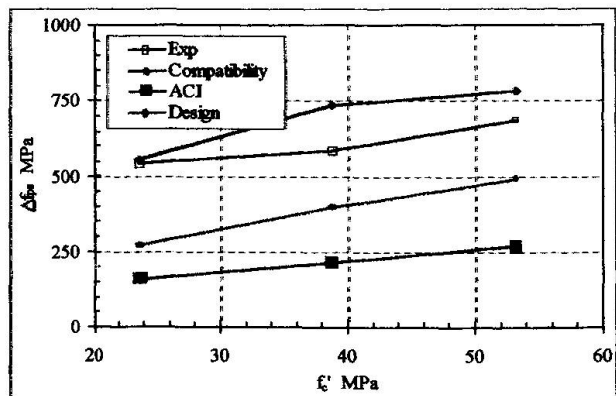

Fig. 4 Effect of concrete strength



concrete strengths. As seen in the figure, with the increase of concrete strength, tendon stress increase has a tendency to rise in all the results of the experiment, the proposed design equation, and the current ACI Code equation. But they differ in the type of tendon stress increase: the tendon stress increase is in the linear shape in the result of the current ACI Code equation whereas it is not in the results of experiment and the proposed design equation. Because the proposed design equation contains the term f_c'/σ_p which is the same parameter as in the ACI Code equation but in the form of a square root.

(3) Amount of tendon (A_{ps})

Fig. 5 shows a comparison of the results of computation and experiment depending on the change of the amount of the tendon. The experimental results coincide well with the results by the strain compatibility method. As the amount of tendon increases, the tendon stress increase shows a nonlinear shape variation in all computed results and experimental results. Thus, it can be said that both the ACI Code equation and the proposed design equations consider the amount of tendon accurately to predict the ultimate stress of unbonded tendon. The difference is that the ACI Code equation underestimates the ultimate stress of the tendon with the range of 73%-77% of the experimental value whereas the proposed design equation predicted it to be 82% of the experimental values.

(4) Amount of reinforcement (A_s)

Fig. 6 compares the results of computation and experiment depending on the change of the amount of reinforcement. As is known in the figure, with the increase of amount of reinforcement, tendon stress increase decreases in computations and experiment. However, ACI Code equation evaluates it with no variations. It is because the current ACI Code equation does not consider the effect of the amount of reinforcement. Since the amount of reinforcement makes an influence on the ultimate stress of unbonded tendon as seen in the experimental results, it is better to consider the amount of reinforcement as a variable like the proposed design equation.

(5) Loading type (f , $L_o/L=1/f+L/d_p$)

The results of the computation and the experiment were compared in Fig. 7 in which the loading types were varied. As seen from the experiments, the tendon stress increases were observed to have similar values in cases of uniform load (4-point load) and 2-point load. As in the proposed design equation, therefore, it is possible to use an identical coefficient for the loading types of the uniform load and 2-point load. However the experimental result for an 1-point load showed smaller tendon stress than those of uniform load and 2-point load. Thus it can be concluded that the loading type affects the ultimate stress of unbonded tendon.

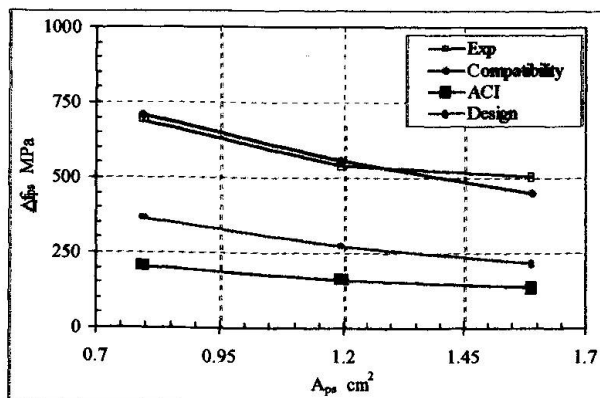

Fig. 5 Effect of amount of tendon

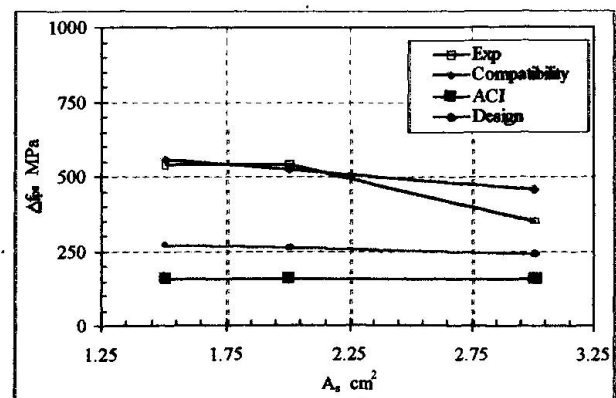

Fig. 6 Effect of amount of reinforcement

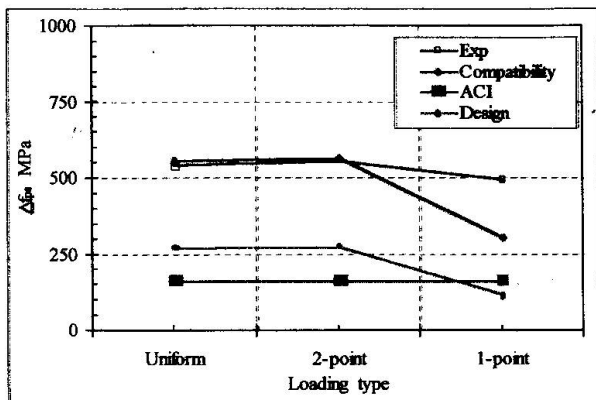

Fig. 7 Effect of loading type

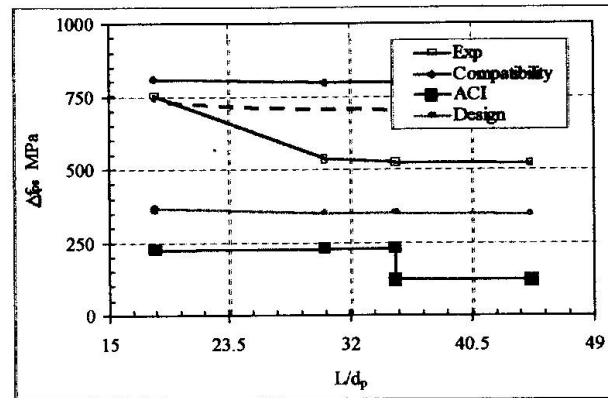

Fig. 8 Effect of span/depth ratio

(6) Span/depth ratio (L/d_p)

Fig. 8 illustrates a comparison between the results of the computation and the experiment depending on the change of span/depth ratio. As is clear in the figure, the stress increase of unbonded tendon decreases when the span/depth ratio is less than 30, but it regularly increases when the ratio is greater than 30. However, the results by the proposed design equation predicted almost uniform values. It is because the function of plastic hinge length ratio is made by the combination of the loading type and span/depth ratio in the proposed equation⁽²⁾. It exhibits a minor influence of the change of the span/depth ratio on the ultimate stress of unbonded tendon when the ratio is over 15, and the ultimate stress of unbonded tendon is influenced more by the loading type rather than by the effect of the span/depth ratio. However, the difference between the results of the strain compatibility method and the experiment is due to the fact that the measurement of deflections was stopped since the capacity of the experimental equipment was over. If the experiment was continued up to the final failure, the tendon stress increase would be the curve shown with the dotted line.

4. Evaluation of proposed design equation

The mean value and standard deviation of the ratio of the prediction to the experiment are illustrated in Table 3 and the comparisons of f_{ps} and $\square f_{ps}$ are shown in Fig. 9. The probable reliance is considered to be good if the average of predicted value/experimental value (f_{psp}/f_{pse}) ratio is higher and standard deviation is smaller. It is also said that the predictions are reliable if the makers in Fig. 9 are close the line of perfect correlation. As the table and figure indicate, the results by the strain compatibility method (Compatibility) predict accurately the ultimate stress of unbonded tendon since predicted value/experimental value is 1.01 at f_{ps} , 1.03 for $\square f_{ps}$.

The proposed design equation can predict the ultimate stress of unbonded tendon more accurately than the ACI Code equation. When compared with the previous design equations, the proposed design equation predicted the tendon stress values which were a little bit less than AASHTO LRFD Code equation. However, the proposed design equation shows a better

Table 3 Average value and standard deviation of predicted value/experimental value (f_{psp}/f_{pse}) ratio

Items	f_{psp}/f_{pse} Ratio		$\square f_{psp}/\square f_{pse}$ Ratio	
	Mean values	Standard deviations	Mean values	Standard deviations
Compatibility	1.01	0.086	1.03	0.286
ACI	0.77	0.081	0.35	0.155
AASHTO	0.88	0.069	0.63	0.184
Harajli/Kanj	0.83	0.074	0.51	0.185
Chakrabarti	0.85	0.086	0.58	0.255
Design	0.84	0.058	0.53	0.166

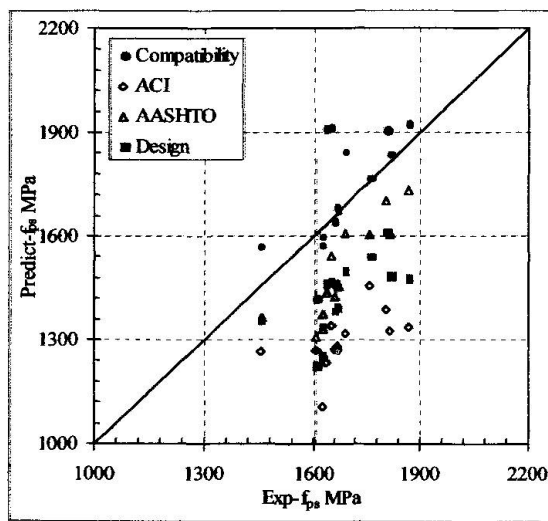

Fig. 9(a) Comparisons of f_{ps}

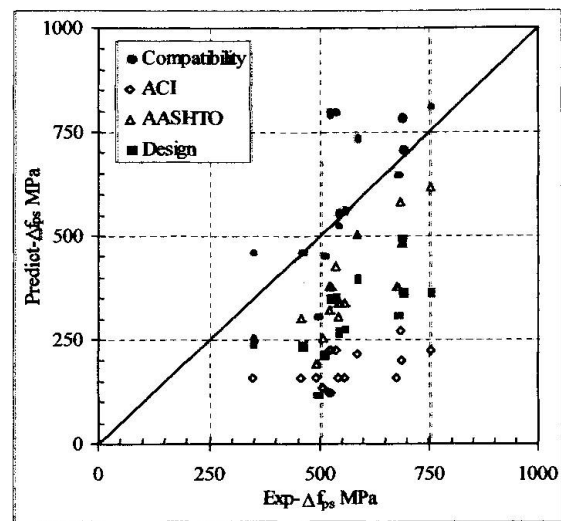

Fig. 9(b) Comparisons of Δf_{ps}

standard deviation. Further AASHTO LRFD Code equation is not suitable for a design purpose because a complex computational procedure is needed to solve a quadratic equation.

5. Conclusions

- (1) The tendon stress increment decreases as the effective prestress increases.
- (2) The parameters of concrete strength, amount of tendons and bonded reinforcements, and loading type were observed to affect on the tendon stresses.
- (3) The tendon stress increments were higher than the ACI Code equation at high values of span/depth.
- (4) The strain compatibility method can predict accurately the stress of unbonded tendon.
- (5) The design equation proposed by the authors can predict the tendon stress accurately with an appropriate safety margin.

Acknowledgment

The authors would like to thank STRESS (advanced STructure RESearch Station) at Hanyang University and Kumho Construction & Engineering Co., Ltd. for providing financial support for this study.

References

1. Jae-Hyung Lim, Jeong-Ho Moon, Seong-Woo Eum, Li-Hyung Lee, "Evaluation of ultimate stress of unbonded tendon in prestressed concrete members(I) -Consideration of ACI code and state-of-art-." *Journal of Korea Concrete Institute*, Vol. 9 No. 4, Aug., 1997, pp 167-176.
2. Jae-Hyung Lim, Jeong-Ho Moon, Seong-Woo Eum, Li-Hyung Lee, "Evaluation of ultimate stress of unbonded tendon in prestressed concrete members(II) -Proposed design equation using strain compatibility-." *Journal of Korea Concrete Institute*, Vol. 9 No. 5, Oct., 1997, pp 105-114.
3. Jae-Hyung Lim, Li-Hyung Lee, "Effect of influential factors on the ultimate stress of



- unbonded post-tensioning tendon." Journal of Architectural Institute of Korea, Vol. 13 No. 10, Oct., 1997, pp 291-300.
4. ACI Committee 318, "Building Code Requirements for Structural Concrete (ACI 318-95) and Commentary (ACI 318R-95)", American Concrete Institute, Farmington Hills, MI, 1995, 369 pp.
 5. Chakrabarti, P. R., "Ultimate stress for unbonded post-tensioning tendons in partially prestressed beams." ACI Journal, Nov.-Dec., 1995, pp 689-697.
 6. ACI-ASCE Committee 423, "Recommendations for concrete members prestressed with unbonded tendon." ACI Journal, May-June, 1989, 18 pp.
 7. Harajli, M. H., and Kanj, M. Y., "Ultimate flexural strength of concrete members prestressed with unbonded tendons." ACI Journal, VOL. 88, No. 6, 1991, pp 663-673.
 8. Naaman, A. E., and Alkhairi, F. M., "Stress at ultimate in unbonded post-tensioning tendons. Part II: Proposed methodology." ACI Journal, Nov.-Dec., 1991, pp 683-692.



The Use of Concrete Design Codes across National Boundaries

W.P.S. DIAS
Associate Professor,
Dept. of Civil Engineering,
University of Moratuwa,
Moratuwa, SRI LANKA



Priyan Dias obtained his doctorate in Concrete Technology from Imperial College, London in 1986, after which he has been an academic at the University of Moratuwa, Sri Lanka. His research interests are in Concrete Durability and in Artificial Intelligence Techniques.

Summary

While code provisions relating to the built environment can easily be transposed across national boundaries, those relating to the social and especially natural environments can, and sometimes need, to be modified before such transposition can be effected. For example, before specifying for durability by strength as per BS 8110, a nation-wide survey should be carried out in order to correlate mix proportions with strength, since such correlations will not be universal, but rather depend on the raw materials used in different countries. Then again, the safety factors that are used for design could be modified for differing situations, with the socio-economic characteristics of developing countries suggesting that load safety factors be lower but material safety factors higher, in comparison with codes in more developed countries.

1. Introduction - Types of Environments

Many developing countries use concrete and other design codes that have been written in developed countries. In many cases, the former have been colonies of the latter. Code guidelines relating to the design of structures and elements for structural behaviour are based on the fundamental theories of structural mechanics. As such, aspects of the design for strength, serviceability and stability (i.e. aspects relating to the Built Environment) that are covered in the codes of one country can be used directly in another without undue difficulty.

However, there are two broad areas where transposition of codes could present difficulties. This is where codes impinge on (i) The Natural Environment (including raw materials and climate) and (ii) The Social Environment (including areas such as safety, quality and economy). This paper gives examples from both the above areas, highlighting one example from each. In most cases, it is the use of British codes in Sri Lankan practice that is described.



2. Influence of the Natural Environment

2.1. Effect of Raw Materials on Specifying Durability by Grade

One of the major changes introduced by the British concrete design code, BS 8110 (1), first issued in 1985, was the specifying for durability by grade and cover. Upto that time, CP 110 (2) had specified for durability by mix proportions such as water/cement ratio and cement content. Although the above change was made, it was still recognised that mix proportions were a more fundamental index of durability than was strength (3). The change in British practice was based on a survey described by Deacon and Dewar (4), where the strengths of OPC concretes that could be achieved in U.K. batching plants for various values of water/cement ratio and cement content were plotted; the grades required for durability were then based on strengths achieved by 96% of the plants. Hence, although durability is specified by grade (in Table 3.4 of BS 8110), it is recognised that mix proportions (which are also displayed in Table 3.4) are the primary indices of durability (3). This is why BS 8110 (1) allows the grade to be reduced by a step of 5 (for OPC concretes) without any penalty of higher cover, if a checking regime establishes that the mix proportion requirement for the higher step is in fact being met by the concrete being supplied. The main reasons for the British change to specifying for durability by grade were (i) the ease by which strength could be monitored and (ii) the resolution of concrete mix design problems that arose when independently chosen grades had to be designed with mix proportions that also had to satisfy durability constraints (4).

The above change, in itself would not have constituted a problem for using BS 8110's Table 3.4 in Sri Lanka. However, British cement strengths had increased significantly and their ready mixed concrete production improved tremendously by the early 1980s (5). This meant that even low cement contents and high water/cement ratios resulted in fairly high grades of concrete - in fact the lowest grade of concrete in Table 3.4 (BS 8110) is grade 30, whereas Sri Lankan practice largely comprised grade 20 and grade 25 concrete.

A study was carried out by the author (6) to compare the strengths obtained in Sri Lankan batching plants located in the capital city of Colombo with those obtained on a major hydropower construction project (Mahaweli headworks, where very careful batching was done) for various cement contents and water/cement ratios. These were also compared with the U.K. values from Deacon and Dewar (4). Some results are presented in Tables 1 and 2.

It can be seen that although the Mahaweli strength results are fairly close to the U.K. ones, the Colombo results are around 10 N/mm^2 lower than the U.K. ones. Closer examination (6) showed that the U.K. cements had higher finenesses and C_3S percentages in their range (Table 3), which would tend to increase 28 day concrete strengths. At the same time, the Mahaweli concretes had better aggregate gradings (Table 3). This is reflected by (i) a higher ratio of coarse to fine aggregate, together with a lower ratio of larger size to smaller size fraction within the coarse aggregate (this type of grading will eliminate gaps between aggregates, leading to better compaction of the concrete) and (ii) a higher proportion of ultrafines (particles less than 0.25 mm) in the mix, which once again will eliminate gaps between aggregate and even lead to a reduced water demand. Both the above will result in higher strengths for given cement contents and water/cement ratios.



Table 1 - Selected comparison of 95% 28 day cube strength values (N/mm^2) vs. w/c ratio

Source (Author / Concrete)	Water/cement Ratio						
	0.75	0.70	0.65	0.60	0.55	0.50	0.45
Deacon & Dewar (4) / U.K.			40	45	50	55	60
Dias (6) / Mahaweli, S.L.	34	37	40	44	50	58	
Dias (6) / Colombo, S.L.	20	23	27	33	41		

Table 2 - Selected comparison of 95% 28 day cube strength values (N/mm^2) vs. cement content

Source (Author / Concrete)	Cement Content (kg/m^3)									
	250	275	300	325	350	375	400	425	450	475
Deacon & Dewar (4) / U.K.		40	45	50	55		60			
Dias (6) / Mahaweli, S.L.			46	48	50	53	56	59	61	64
Dias (6) / Colombo, S.L.	29	33	36	39	42	46	49			

Table 3 - Comparison of cement properties and aggregate grading

Concrete Type	U.K. (5,7)	Mahaweli	Colombo
Cement Fineness (m^2/kg)	287-390	310-338	311-343
7 day Mortar Compressive Strength (N/mm^2)	43.6	40.0-42.1	40-50
C ₃ S Percentage in Cement	45-64	48.0-56.7	47.8-58.0
Coarse/fine aggregate ratio		1.32-2.15	0.96-1.54
Larger/smaller size fraction in coarse aggregate		1.47-2.86	4.0
Fines < 0.25 mm in Fine aggregate		24.5	5
Fines < 0.25 mm in Total aggregate		7.78-8.78	2.30-2.55

Table 3 shows therefore that the Colombo plants are unable to achieve higher strengths for given cement contents and water/cement ratios, because they neither have very high quality cements nor optimised aggregate gradings - i.e. good quality raw materials. If the raw materials for the Colombo plants are to be used to produce the BS 8110 durability grades, very high cement contents would be required; this in turn could cause thermal and shrinkage cracking that would impair the very durability that is being sought.

This problem can be resolved by suggesting lower grades in BS 8110's Table 3.4, grades that have been arrived at on the basis of a survey of Sri Lankan batching plants (6). A similar approach has been taken by the Irish Republic as well (8).

In the above context, Eurocodes are an interesting development. They may in fact be more relevant for developing countries, because the countries that form "Europe" themselves are fairly disparate in economic status and level of development. As such, it will not be possible to maintain throughout Europe the same practices as for example in Germany and the U.K., and this would be reflected in the Eurocodes. An example of this is the reverting back to water/cement ratio and cement content in specifying for durability (9).

Another consideration in this regard is the very definition of appropriate environmental conditions, which will also vary from one country to another. An attempt has been made (10) to "compare" the 5 durability environments in BS 8110 with the 9 environments defined in EC2.



2.2. Other Influences of the Natural Environment on Design Practice

The ambient temperatures in a country will influence thermal effects in concrete. The heat of hydration temperature rise (T_1) values given in BS 8007 (11), i.e. the concrete design code for water retaining structures, correspond to the U.K. based ambient temperature of 15°C. As Sri Lankan ambient temperatures are another 15°C higher, at least some of these T_1 values will have to be increased appropriately; perhaps even to the extent of 0.5°C for every °C change in ambient temperature (12).

Another area where local values are appropriate is the use of relevant wind load values. Basic wind speeds in Sri Lanka can be obtained from a design guide (13) developed in the wake of a cyclone on the East coast in the late 1970s.

3. Influence of the Social Environment

3.1. Effect of Safety Factors on Design Economy

The differences in the socially accepted levels of safety across national boundaries could also influence design practice. This is reflected in the safety factors (generally the load safety factors) that are adopted. For example, the partial safety factors for loads in Eurocode 2 (14), which is the Eurocode for concrete design, are 1.35 for dead and 1.5 for imposed loads. These are less than the factors in BS 8110 (which has 1.4 for dead and 1.6 for imposed loads).

The results of a comparison (10) between the BS 8110 and EC2 bending moments in a multi-bay braced portal frame structure are given in Table 4. Apart from the above mentioned difference in load safety factors, the EC2 code specifies the "adjacent spans loaded" combination in place of BS 8110's "all spans loaded" combination. This causes higher beam moments at interior supports for EC2 analyses; apart from this, however, EC2 analyses give lower moments in both beams and columns.

Table 4 - Comparison of portal frame moments from analyses as per BS 8110 and EC2 (10)

Element	Location	Comparison
Beams	End support	EC2 values 4-9% below BS 8110 values
	Near middle of first span	EC2 values 4-11% below BS 8110 values
	First interior support	Very similar (+ or - 5%)
	Near middle of other spans	EC2 values 12-20% below BS 8110 values
	Other interior supports	EC2 values up to 15% above BS 8110 values
Columns	Outer column	EC2 values 4-9% below BS 8110 values
	Interior columns	EC2 values up to 50% below BS 8110 values

If it is perceived that codes are too conservative, the industry could begin to reduce the levels of safety, especially for construction in the informal sector. For example, when the Sri Lankan industry was using CP 110 (2), a limited questionnaire survey (15) was carried out among three classes of construction industry personnel, namely Construction engineers working for contractors (Class A), Site engineers working for consultants (Class B), and Design engineers working for consultants (Class C); each of the above was also categorised with respect to experience in the construction industry, i.e 0-10 years (Category 1) and over 10 years (Category 2). They were asked to give their design solutions (in terms of slab thickness and spacing of 10 mm dia. high yield reinforcement) for a continuous one way slab system of spans 3.5 m and 5.0 m for both domestic and office buildings.



The domestic buildings were to be for their own dwellings, while they were to design the office buildings as part of their professional practice. The effective safety factors they were using could be back-calculated by assuming a dead load allowance of 1.5 kN/m^2 for partitions and finishes, and characteristic imposed loads of 1.5 kN/m^2 and 2.5 kN/m^2 for domestic and office buildings respectively.

The class- and category-wise means and also overall means for effective safety factors are shown in Table 5. This indicates that the overall mean effective global safety for one way slabs in domestic buildings was 1.6, compared to the CP 110 value of around 1.7; however, the latter value was in fact maintained or even exceeded for one way slabs in office buildings. The safety factors employed for 5.0 m spans was less than that for 3.5 m spans; it appears here that some safety was being sacrificed for economy. Also, it appears that the lower safety factors were being used by design engineers and those with over 10 years of experience - i.e. people who were presumably well aware of the implications of their actions. It must be emphasised, however, that a wider survey is required to corroborate the above trends, as there were only 18 respondents to the questionnaire.

Table 5 - Mean effective global safety factors from survey of one way slab designs (15)

Structure Type	Class A	Class B	Class C	Category 1	Category 2	Overall
Office - 3.5 m span	2.125	2.063	1.874	1.983	1.980	1.98
Domestic - 3.5 m span	1.973	1.858	1.616	1.758	1.770	1.76
Office - 5.0 m span	1.792	1.701	1.350	1.608	1.448	1.57
Domestic - 5.0 m span	1.742	1.598	1.150	1.450	1.379	1.42
Office (overall)	1.958	1.882	1.874	1.983	1.714	1.77
Domestic (overall)	1.857	1.728	1.397	1.611	1.575	1.60
3.5 m span (overall)	2.049	1.961	1.745	1.870	1.875	1.87
5.0 m span (overall)	1.767	1.649	1.256	1.533	1.414	1.49
All types	1.91	1.81	1.51	1.71	1.65	1.66

3.2. Other Influences of the Social Environment on Design Practice

The above discussion suggests that slightly lower load safety factors could be appropriate for developing countries. On the other hand, reductions in materials partial safety factors should be avoided, because construction practices, including the procurement or production of construction materials, are likely to be less stringent in developing countries. For example, the partial safety factor for reinforcement in BS 8110 has recently been reduced from 1.15 to 1.05, no doubt because of improved production practice in the U.K. This however would be clearly inadvisable for a country such as Sri Lanka to adopt, because of the wide variety of imported steels (with widely varying properties) that are used there.

Imposed loads could also vary from one country to another, and statistical information on live loads is scarce in all countries. A preliminary survey of office buildings in Sri Lanka yielded a value of 2.3 kN/m^2 for the equivalent uniformly distributed imposed load for office buildings (15) - the value in the British loading code is 2.5 kN/m^2 (16).



4. Conclusions

The built environment, natural environment and social environment have been identified as three environments that are addressed by design codes. Code provisions relating to the built environment can easily be transposed across national boundaries. Those relating to the social and especially natural environments can, and sometimes need, to be modified, after carrying out national surveys. For example, this paper has described a proposal for reducing the BS 8110 concrete durability grades by 5 for Sri Lankan practice, after a batching plant survey; and how practising engineers in Sri Lanka indicated their preference for the slightly reduced global factor of safety of 1.6, compared to the CP 110 provision of around 1.7, for the design of one way slabs. Other areas that may require modification have also been identified, namely heat of hydration temperature rise values, basic wind speed values, imposed load values and material partial safety factor values.

5. References

1. BS 8110: 1985. Structural use of concrete, British Standards Institution, London.
2. CP 110: 1972. The structural use of concrete. British Standards Institution, London.
3. Dias, W.P.S. Specifying for concrete durability: Part 1 - A critical review. *Engineer*, December 1991, pp. 51-63.
4. Deacon, C. and Dewar, J. Concrete durability - specifying more simply and surely by strength. *Concrete*, February 1982, pp. 19-21.
5. Changes in cement properties and their effects on concrete. Report of a Concrete Society Working Party, Concrete Society, London, September 1984.
6. Dias, W.P.S. Specifying for concrete durability: Part 2 - The Sri Lankan context. *Engineer*, Vol. XX, 1992, pp. 4-24.
7. Corish, A.T. and Jackson, P.J. Portland cement properties - past and present. *Concrete*, July 1982, pp. 16-18.
8. IS 326: 1988. Code of practice for the structural use of concrete. National Standards Authority of Ireland, Dublin.
9. ENV 206: Concrete - Performance, Production, Placing and Compliance Criteria, Final Draft, February 1989.
10. Concrete Structures: Eurocode EC2 and BS 8110 compared, (ed.) R.S. Narayanan, Longman Scientific & Technical, London, 1994.
11. BS 8007: 1987. Design of concrete structures for retaining aqueous liquids. British Standards Institution, London.
12. Harrison, T.A. Early-age temperature rises in concrete sections with reference to BS 5337:1976. Cement & Concrete Association, Slough, 1978.
13. Design of Buildings for High Winds, Sri Lanka. Ministry of Local Government, Housing and Construction, Colombo, July 1980.
14. EC 2: Design of Concrete Structures, Commission of the European Communities, 1992.
15. Dias, W.P.S., Mansur, U., Makewita, M.A.S.M. and Perera, J.A.A.K. A preliminary investigation into the safety factors and live loads for office and domestic buildings in Sri Lanka. *Engineer*, June 1991, pp. 19-31.
16. BS 6399: Part 1: 1984. Design loading for buildings: Code of Practice for dead and imposed loads. British Standards Institution, London, 1984.



The Compatibility of Concrete Strength with High Strength Reinforcing Steel

Abhay KUMAR JAIN
Sr. Lecturer & R/S (QIP)
Dept. of CE-AM
SGSITS Indore (M.P.)
India

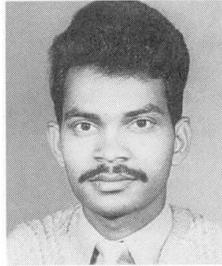

Abhay Kumar Jain, born 1963, received his civil engineering degree from APS University in 1985 and M.Tech (Str.) from Indian Institute of Technology, New Delhi.

O.P. BHATIA
Professor
Dept. of CE-AM
SGSITS Indore (M.P.)
India

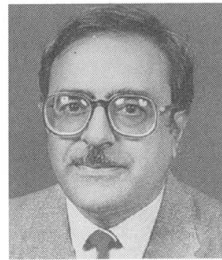

O.P. Bhatia, born 1940, received his civil engineering degree from Jabalpur University 1963, M.E.(Trans.) in 1965, and Ph.D. in 1982. He is currently professor & head of civil engineering and applied mechanics department at SGSITS Indore (M.P.)

Summary

It has been observed that the use of HYSD bars with low strength concrete develop more number of cracks in the structure in comparison with plain round bars and same concrete strength. The paper describes one cause of distress due to inadequate compatibility of reinforcing steel with concrete strength, at ultimate load and foresee how the cracks formed in a structure because of above cause. The cracks, thus formed provide the paths to ingress the aggressive ions in the concrete which may rust the embedded steel.

1. Introduction

Only the mass produced mild steel was initially used as a reinforcement. Later it was thought that the cost of reinforcement can't be reduced by the use of steel having a lower cost per unit weight. For this reason research and development has been carried out on mass scale to produce the steel of high yield strength. Now a days numerous steel grades are available to suit the construction requirements. Peoples started the use of High Yield Strength Deformed (HYSD) bars with low strength concrete without taking care of the compatibility of reinforcing steel with concrete. Such type of combination develops numerous cracks in a structure which ultimately affects the safety, serviceability and durability requirements.

2. Effect of high yield strength deformed steel on steel concrete bond

The properties of R.C.C. structure depends upon the bond between steel and concrete. When a reinforcing bar is embedded in concrete, the concrete adheres to its surface and resist any force that tries to cause slippage of bar relative to its surrounding concrete. This is achieved by the development of the shear stress at the interface of bar and concrete. The bond transfer stresses from one material to other. At ultimate load, slipping of bar relative to concrete should not cause ultimate failure as long as the bar is not pulled out at the ends. Bond stress developed at the interface of steel and concrete are due to pure adhesion, frictional resistance, and mechanical resistance. The bond resistance of plain bar is due to adhesion and friction between concrete and steel. However even at low tensile stress, adhesion between concrete and steel will break, causing slippage of steel. After the occurrence of the slip, further bond is developed by friction between concrete and steel. Shrinkage of concrete grips reinforcement and increases the bond between the concrete and the steel. Failure of bond occurs when adhesion and frictional resistance are overcome and the bar is pulled leaving a round hole in the concrete. To prevent this, end anchorage is provided, in the form of hooks. If the end anchorage is adequate, such a beam will not collapse even if the bond is broken over the entire length. This is because the member act as a tie arch.

Deformed bar increases the bond capacity due to mechanical resistance in addition to adhesion and frictional resistance. Therefore the bond failure due to pulling of bar does not occur, but the surrounding concrete which is subjected to excessive circumferential tensile stress will fail by splitting.

3. Experimental planning

Rectangular beams in which plain mild steel bars and high yield strength deformed bars were employed as reinforcement were designed in accordance with the R.C.C. theory in order to carry out flexure test. End anchorage is provided, to all the main bars, in the form of hooks. Typical reinforcement details for beams are illustrated in Fig. 1. In the preparation of concrete for fabrication of beams, ordinary portland cement (OPC 53 Grade), river sand and crushed black granite of 20 mm maximum size were used as ingredients. Concrete beams reinforced as above were constructed in two series. In series 1, the proportion in which these constituent materials were mixed in making the concrete was 1:2.6:4.0 with water cement ratio 0.62 by weight while, in series 2, the proportion of these constituent materials was 1:2.0:2.9 with water cement ratio 0.53 by weight. Beside beams, control cubes to assess the compressive strength of concrete and control beams for flexural tensile strength were also prepared.

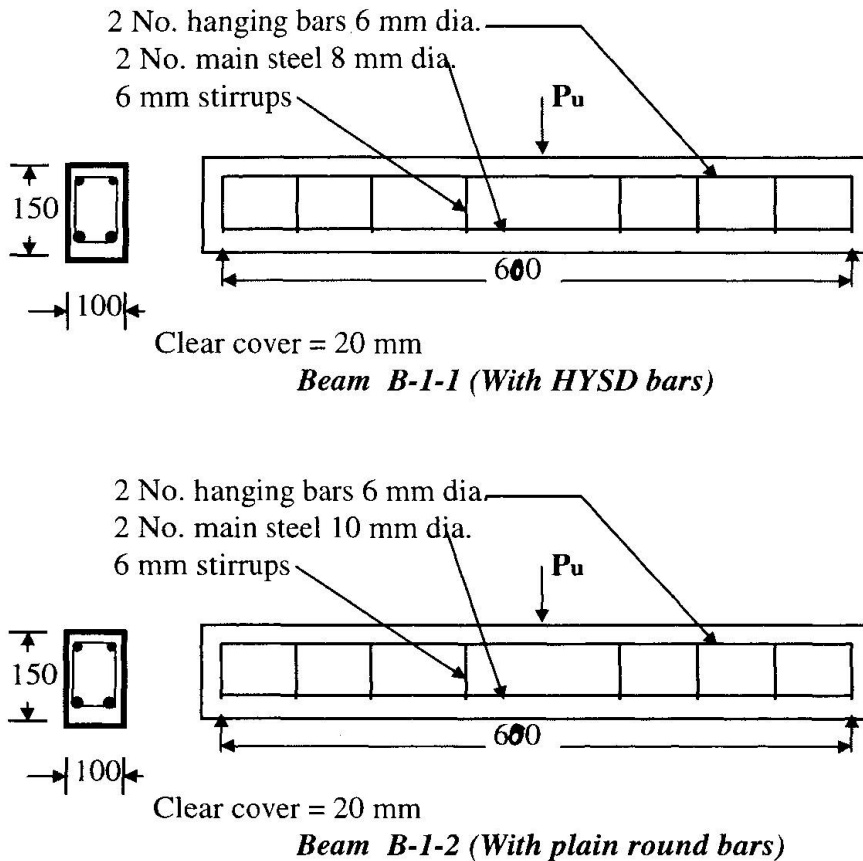

Fig. 1 Typical Details of Test Beams for Static Loading

Beams were loaded as shown in Fig.1. Load was applied on beams using hydraulic jack in an increment of 1.0KN. The load corresponding to first visible crack was carefully observed and recorded. Thereafter for each load increment, cracks were marked along the depth of the beam as and when they grew under load. Load was increased monotonically up to the failure of the beam. The load at which the failure of beam occurred, was recorded. In all the beams the failure was due to crushing of concrete at top in the compression side of the beam. Fig. 2 depict a typical crack and failure pattern of beams tested under flexural load. The first crack load and the ultimate load for all the beams are given in Table 1.

Table 1 Results of flexure tests

Beam No.	First Visible Cracking Load (KN)	Ultimate Load (KN)
B-1-1	15.0	41.0
B-1-2	13.0	43.0
B-2-1	18.0	47.0
B-2-2	16.0	48.0

4. Test results and discussion

Fig. 2 shows the comparison of the formation of cracks in beams of two series reinforced with plain round mild steel bars and high yield strength deformed (HYSD) bars from the flexure test. Details of flexural load tests are given in Table 2. For beams of series 1, it is observed that the average volume of the cracks expressed as a percentage of the volume of the specimen is about 1.5% for the beams reinforced with HYSD bars, whereas the corresponding value is 0.8% for the beams with plain round mild steel bars. Therefore for the series 1, the beams with HYSD bars develop about 90.0% more crack volume as compared to beams with plain round bars. The formation of cracks in the tension zone of a beam subjected to a given loading depends to a large extent on surface texture of embedded steel rods i.e. bond between the concrete and reinforcing steel and flexural tensile strength of the concrete. After the formation of the first crack, the concrete is free from strain at the cracked surface and the strain tends to increase towards the centre between the two cracks. A little consideration shows that a further increase of the load will result in an increased strain of the concrete between the cracks so that the concrete will share the transmission of the force in accordance with the developed bond between the concrete and reinforcing steel. This will continue until the bond resistance has been overcome so that the bar slips in the concrete and the stress set up in reinforcing steel between the cracks and in a crack become equal. In some cases where the bond strength between the steel and concrete is more in comparison to modulus of rupture of the concrete, as in case with HYSD bars and low strength concrete, then the rupture elongation of the concrete may exceed the permissible value and a new crack may form between the two existing cracks before the bond resistance is overcome. These considerations lead to recognition that the concrete beams reinforced with plain mild steel bars will form very few cracks which will be fairly wide because they must accommodate the entire strain of the steel slipping in concrete. On the other hand the concrete reinforced with HYSD bars will tend to form number of cracks, between which the bond strength between concrete and steel is maintained. In case of beams with HYSD bars, the bond between the steel and concrete is more than the rupture elongation of the concrete and hence the numerous cracks formed.

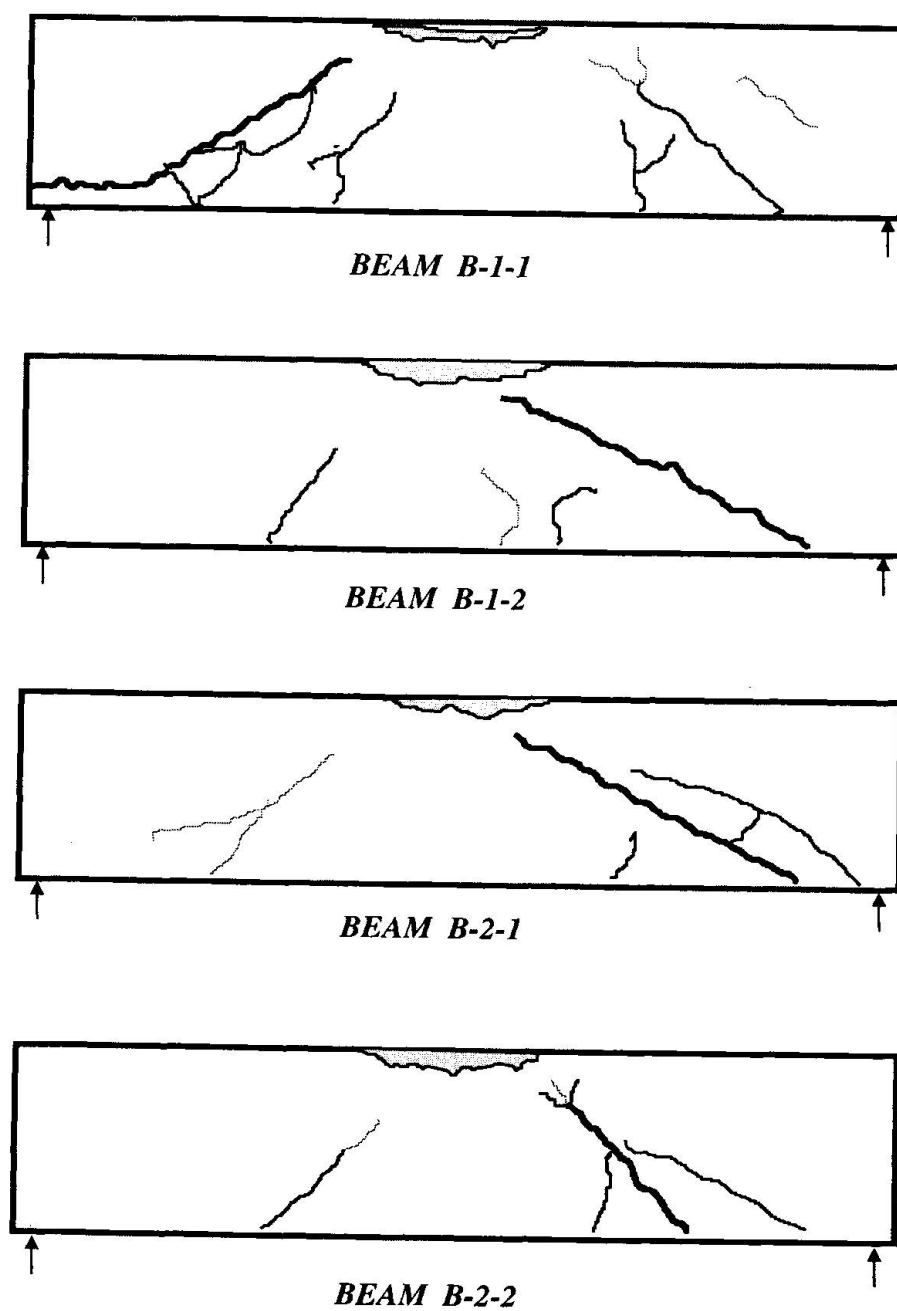

Fig. 2 Cracks and Failure Pattern of Beams Under Flexure



In beams of series 2, it is observed that the average volume of the cracks expressed as a percentage of the volume of the specimen is about 0.45 % for the beams reinforced with HYSD bars, whereas the corresponding value is 0.30% for the beams provided with plain round mild steel bars. This may be because of high flexural strength of the concrete as compared to the concrete of series 1.

Table 2 Details of flexural load test

Beam No.	Concrete strength (MPa)		Steel type	Avg. No. Of Cracks	Volume of cracks (% of the specimen volume)
	Comp.	Flexural			
B-1-1	19.0	3.50	HYSD	8	1.50
B-1-2	19.0	3.50	M.S.	4	0.80
B-2-1	28.0	4.60	HYSD	5	0.45
B-1-2	28.0	4.60	M.S.	4	0.30

5. Conclusions

The results of the study show that with HYSD steel, the average volume of the cracks in beams made with concrete of 28-day strength 28.0 MPa is significantly less as compared to beams made with concrete of 28-day strength 19.0 MPa, whereas the concrete beams reinforced with plain mild steel bars form very few cracks and hence the less crack volume. Therefore it is suggested that the HYSD bars used for reinforcing the concrete should be compatible with concrete strength to minimize the cracks in the structures, hence it should not be used with low strength concrete whose tensile strength is less as compared to bond strength. For this reason the most suitable combination of steel and concrete is that in which the bond strength between concrete and steel is less than the rupture elongation of the concrete or the most suitable concrete strength for HYSD steel is that in which the cracks volume will be as small as possible for a level of stress in steel corresponding to maximum allowable load.

6. Reference

1. Price, W.H., "Factors Influencing Concrete Strength," Journal of the ACI, Vol. 47, No.6, pp. 417-432, 1951.
2. Neville, A.M., "Properties of Concrete", The English Language Book Society and Pitman Publishing, Third Edition, 1983.
3. Mindess, Sydney and Young, J. Francis, "Concrete", Prentice-Hall, Inc., Englewood Cliffs, New Jersey, 1981.
4. Beeby, A.W., "Corrosion of Reinforcing Steel in its relation to cracking," The Structural Engineer (London), V.56A, No.3, pp. 77-81, 1978.
5. Martin, H. and Schiessel, P., "The Influence of cracks on the Corrosion of Steel in Concrete," Preliminary Report RILEM, International Symposium on Durability of Concrete, Prague, V.2, 1969.
6. Sinha, S.N., "Reinforced Concrete Structures," Published by Tata Mc-Graw Hill, New Delhi, First Revised Edition, 1990.



Code Calibration and Optimisation through Asian Model Code

Srinivasan Coimbatore NARAYANARAO

Partner
M/s.C.R.Narayana Rao
Architects & Engineers
Chennai, India

C.N.Srinivasan, born 1941 received his Bachelor of Technology (Honours) from the Indian Institute of Technology, Kharagpur and subsequently Master of Science from the University of Illinois, U.S.A and Doctor of Philosophy. He is actively involved in Indian Code Committees on Concrete and Loading Standards.

Raghuram Coimbatore SRINIVASAN

Graduate Student, University of Illinois,
Urbana, Illinois, U.S.A

C.S.Raghuram is currently graduate student in University of Illinois, Urbana, Illinois, U.S.A

Summary

Asian Model Code (AMC) would be addressing the needs of a majority of world's population – a body in a great hurry to make up the lost time but beset with meagre resources matched only with its high ambitions. This explosive blend places a heavy responsibility on the Code formulation. Some of the major issues that need to be addressed, problems to be resolved and pitfalls avoided are brought out in this paper.

1. Introduction (Opportunity and threat)

The Asian Model Code (AMC), when drawn and put into effect would enjoy an audience of over 60% of the world's population. One can well imagine the onerous responsibility that is placed on the Code Committee.

AMC starts with an advantage that the entire region enjoys certain conformity in basic values, aspiration, climatic conditions and importantly, the cost functions. The region is also characterized by a paucity of resources as well as the existence of an abundant semi-skilled work force, trained in traditional construction practices. Hence AMC stands the best chance of universal acceptability in the region.

However, there does not exist sufficient interaction amongst the Nations of this region as there does amongst those of the European Union. Also there has not been any concerted



effort at sustained regional research. These conditions make it difficult for the adoption and formulation of AMC.

This paper, seeks to address the question of code calibration and therefore, through this, Optimization. Further, possible problems and pitfalls in formulating the AMC are briefly covered.

A Code is basically is an exercise in number crunching. A set of numbers need to be laid down to define an acceptable design domain eg. allowable stresses, load factors, sampling, testing procedure and frequency, acceptance criteria, allowable tolerances, minimum requirements such as cement content, span to depth ratios, age factor, serviceability requirements, to cite a few.

These numbers are fixed by the Code Committee, keeping in view, the latest research, International Codes, Industry Practice duly tempered by their respective National past practices, status and projected progress of available technology and know-how and know-why available to the profession ⁽¹⁾

Many questions are often debated during code formulation such ⁽²⁾ as :

- Should money be spent on research and evolution of design parameters and limitations, or for the extra materials that go into the structure as a penalty for such ignorance?
- Should money be spent on obtaining quality control of material through rigid acceptance criteria and allowing higher stresses, or

on compromising with a poorer control and paying the penalty for the lack of quality through additional materials?

Fixing these values is the first level of optimization on a National scale. One can easily appreciate the even a slight change in the number eg. the depth to span ratio of slabs or minimum cement content or maximum steel percentage will have a far reaching cost impact, in view of the large volumes involved.

These numbers are arrived at, through an interplay of conflicting/supplementing technologies.

Having arrived at a National level numbers, designers through their individually inspired excellence optimize their specific designs to get the best value for the end users. This is the second level of optimization.

More enlightened designers go a step further into the basic philosophy of arriving at these numbers, to use the benefits available in using alternative methods, rigorous analysis (say of crack width, deflection, creep calculation, stricter QA methods⁽³⁾) and this leads further into a third level of optimization ⁽⁴⁾



In specifying the numbers, codes have a further responsibility: - viz. structures built in the yester years are not rendered prematurely obsolete causing a heavy insurance, legal, retooling and replacement cost.

As a corollary, unless backed by solid evidence, drastic liberalization from levels or from current National codes is not to be resorted to. ⁽⁵⁾

These are the upper and lower bound limits against which the design and detailing parameters are to be calibrated.

In a society where certain serviceability requirements (eg. noise level, vibration level) are non existent, a question often asked is whether, the building can be treated as yet another consumer product ⁽⁶⁾. A building with an appropriately less stringent serviceability requirement (say deflection) can be built at a lower cost. (Indian Standard / Loading standard ⁽⁷⁾ for example, specifies a lesser imposed load for low cost housing).

While all this number game may appear all “Science and Technology”, the pulse of users (the designers and through them the consumer viz public) is what finally makes or mars the Code.

Taking a few examples from Indian Code Drafting Scheme:

- a) At one stage of revision, I.S Loading Standards (IS : 875), some years back, increased the live load on sloping roofs as also wind loads under a severe revolt by the Indian Engineering Association which had under its fold, steel structural manufacturers, these values were scaled down to a none too scientific intermediate value.
- b) More recently, an amendment to impose a limiting deflection on purlins was decided to be put on hold, as new cloaking materials are being introduced into the Indian market.

The bottom line is to provide a level playing field for competing technologies.

If for example, limiting deflection value is different between say, insitu and precast system on one hand (say $L/325$) and metal building (say $L/60$), then the dice is loaded against one system.

A level playing field then cannot be said to be existing in evaluating the competing systems in arriving at a most cost-effective structure, falling inside the accepted design domain.



2. Objective function

The AMC would have to start with the following ground realities :

- i) Level of Technology, material availability, design and construction capabilities, cost indices of component materials and competing technologies available in the member Nations.
- i) Construction practices and levels of quality assurance (QA).
- ii) General conformity with the respective National codes currently in vogue.
- iii) Values of various National Codes are to be reconciled. For example, maximum percentage of steel reinforcement in column in the Indian Code is 4% while in the Japan Code it is 2%. While sound reasoning has preceded before these values have been pegged, similar and identical design requirement (eg. seismic load) would call for identical values.

Based on the above data, a set of most acceptable design parameters will have to be laid down.

In this process, the AMC will have to adopt certain Lowest Common Multiples (LCM) or Highest Common Factors (HCF) as values for the code parameters from amongst the National codes consistent with sampling testing and acceptance criteria of the respective National Codes. The AMC cannot said to have achieved its objective, if it does not recognize progressive technology up-gradation, such that fruits of technology (eg. Ready mix concrete, pre-cast construction, higher QA requirements) are immediately translated to effectively reduce cost, time, and enhance durability, saving precious raw materials or energy.

While this in itself is a formidable task the AMC must note the following points:

One – the need to maintain certain uniformity with the other existing structural codes of the member Nations (eg. effective length factors of steel and concrete codes, need to be the same).

Two – the smooth transition between AMC and existing structural codes especially in case of mixed construction (concrete encased or in filled steel construction).

I therefore make bold to suggest that as an achievable first step, the AMC should confine itself to following a “Life – Limb” policy of code formulation ⁽⁷⁾.

That is to say, the AMC may deliberately choose to stop with specifying values and laying down procedures, that will include a common minimum programme pertaining to ‘Limit State’, involving safety (to Life and limb of the user) and leave the serviceability criteria to the user Nation. This will also help formulating and implementing the AMC within a reasonable time frame.

A dilemma often faced by the code formulative body is whether the code should precede introduction of technology or technology ingress should precede code clauses. The chicken and egg syndrome.



As upgrading and wide dissemination of technology is an important function of code, the AMC may also address itself, to obtaining concrete of quality.⁽⁸⁾ Concentrating on quality of ingredient materials, making, placing and compacting of concrete, curing and form work, detailing of reinforcement for durability etc. and also lay down more rigorous methods of analysis of structures, doing away with empirical methods (eg. empirical methods of flat slabs design, experimental investigation method of design).

Wide spread and voluntary acceptance of AMC, is only possible through certain levels of official recognition. Placing AMC on an equal footing with National Codes, for domestic use, and giving it an edge – albeit marginal – in case of international operation in the works in the Asian Continent, is one way of making it popular.

Thus, so far, the author has sought to expose and highlight the possible areas of conflict resolution and lay down common minimum programme in drawing up AMC. While it is recognised that there is no easy solution, the basic cultural values, and commonality of the problems that individual constituent countries face, give the AMC a head start in effective implementation of AMC.

3. Future work

Having successfully implemented AMC, the next step could be to integrate the loading standards (eg. imposed load, load combination, reduction in loads, in upper floor of multi-storey buildings), other structural codes (particularly structural steel with AMC) and laying down common serviceability requirements.

Conclusion

While the underlying philosophy of each of the questions raised may by itself need tremendous patience and skill in resolving them, one can imagine the complexity of the exercise, when finally one has to reduce these philosophical journeys into a set of consistent numbers. But the very thought that AMC will address a population far vaster than anything, so far even attempted, is sufficient to fuel the imagination and motivate the AMC formulating body.

Reference

1. Srinivasan, C.N. – Discussion on – Public safety is it compromised by new LRFD Design – Journal of Structural Engineering, ASCE, Structural Division, January 1995.
2. Srinivasan, C.N. – Rational Structural Design and Codes of Practice, Journal of Institution of Engineers India, Vol. 50, July 1970.
3. Emilio Rosenblueth, Estenal, Damy J.E. – Bonus and Penalty in Acceptable Criteria For Concrete – Journal of American Concrete Institute – Vol 71, No. 9, Sept. 1974
PP. 466-472.



4. Srinivasan, C.N. – Journal of Structural Engineering, ASCE, Structural Division – Vol. 118 No. 10, Oct. 1992 Page 2946.
5. David V. Rosowsky, A.F. Hassan & N.V.V Phanni Kumar – Calibration of Current Factors in LFRD Design – Journal of Structural Engineering, ASCE – Vol 120, No.9, Sept. 1994.
6. Srinivasan, C.N. – Journal of Structural Engineering, ASCE, Structural Division – Vol 118 No. 10, Sept. 1997 Proc. 1889.
7. IS : 875 : 1984 – Loading Standards – Bureau of Indian Standards, New Delhi, India.
8. Emilio Rosenblueth – Towards Optimum Design through Building Codes – Journal of Structural Engineering, Structural Division, ASCE, Vol. 102, ST 3, March 1976.



Model Code Format for long term analysis of R.C. and P.C. structures

Franco MOLA
Structural Civil Engineer
Politecnico di Milano
Milano, Italy

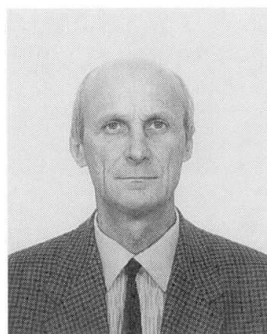

Franco Mola, born 1946, received his civil engineering degree from Politecnico di Milano in 1971. He is currently professor of Theory and Design of R.C. and P.C. Structures, Department of structural Engineering, Politecnico di Milano.

Summary

A Code Format approach for the long term analysis of concrete structures is presented. The formulation is based on the algebraic form of creep constitutive law recommended by CEB. In order to make feasible for practical applications the CEB algebraic law, the statements of a basic theorem proven by the author are applied. In this way a simple procedure exhibiting high accuracy and requiring only elastic calculations is derived. The application of the proposed procedure to the long term analysis of P.C. sections subjected to prestressing, external loads and shrinkage allows to derive feasible design formulas easily implementable in a Code Format.

1. Introduction

In CEB – FIP Model Code 90 /1/ the new CEB creep model has been introduced. This model, based on a product form of the creep function, shows a good agreement with experimental data and the related mathematical formulation is rather similar to the one pertaining to ACI model, /2/. The direct application of CEB MC90 model to structural analysis is quite complex as it requires the solution of systems of Volterra integral equations, making the use of general purpose computer programs mandatory. In Europe, after the publication of CEB MC90 some Design Aids have been prepared, /3/, in order to give to practitioners basic information regarding the correct way of approaching long term structural analysis, albeit for very simple structural arrangements. In order to investigate more complex systems without recurring to heavy calculations the algebraic form related to the so-called Age Adjusted Effective Modulus Method (AAEMM) has been proposed. The application of AAEMM drives to an elastic formulation including an imposed deformation linearly depending on the initial one, so this method cannot be directly applied by using current computer programs of structural analysis. In fact in their most popular configuration these programs can accept only inelastic imposed deformations. In searching for the possibility of directly apply AAEMM when using general computer programs, the author has proven that the solution can be obtained by combining three particular elastic solutions using a convenient time variable combination coefficient.

In this way AAEMM can be immediately implemented on general purpose computer programs as no particular imposed deformations are needed. In the present work a detailed discussion about this new way of proceeding is presented and the application to the long term analysis of P.C. sections will be developed, deriving simple Code Format design formulas.

2. General formulation of concrete viscoelastic law

According to McHenry Principle of Superposition /4/, the uniaxial creep stress-strain law for concrete can be written in the following form

$$\varepsilon(t) = \int_0^t d\sigma(t') J(t,t') + \bar{\varepsilon}(t) \quad \sigma(t) = \int_0^t d(\varepsilon(t') - \bar{\varepsilon}(t')) R(t,t') \quad (1)$$

with $J(t,t')$ creep function, $\bar{\varepsilon}(t)$, imposed deformation, $R(t,t')$ relaxation function. Introducing the creep coefficient $\varphi(t,t')$ representing the ratio between the delayed deformation due to creep and the initial elastic one, we can write

$$J(t,t') = 1/E(t') (1 + \varphi(t,t')) \quad \int_0^t \frac{\partial \varphi(\tau,t')}{\partial \tau} R(t,\tau) d\tau = E(t') \quad (2)$$

The application of eqs. (1) to structural analysis using the Force Method leads to systems of Volterra integral equations requiring appropriate algorithms for their solution. These algorithms are based on iterative procedures to be implemented in computer programs so they cannot be directly incorporated in a Model Code Format. A simplified form of the first of eqs. (1), feasible for the engineer approach to structural problems and exhibiting good reliability, is the following algebraic relationship stated by Trost /5/

$$\varepsilon(t) = \sigma(t) [1 + \chi(t,t_0) \varphi(t,t_0)]/E(t_0) + \sigma(t_0) \varphi(t,t_0) [1 - \chi(t,t_0)]/E(t_0) + \bar{\varepsilon}(t) \quad (3)$$

$$\chi(t,t_0) = 1/(1 - R(t,t_0)/E(t_0)) - 1/\varphi(t,t_0) \quad (4)$$

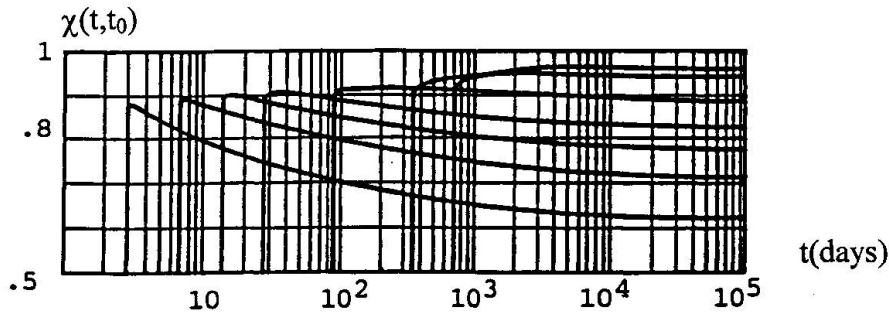

Fig.1 Ageing coefficient $\chi(t,t_0)$ according to CEB model

In fig.1, the ageing coefficient χ , calculated according to the CEB creep model /1/, is reported for particular values of the main parameters, namely the concrete strength f_{ck} , the notional thickness h_0 and the relative humidity RH. The χ coefficient lies at the interior of the interval $0,5 \leq \chi \leq 1$ and when considering time intervals $t - t'$ sufficiently large, we can assume $\chi = 0,8$ as suggested by CEB MC90 for preliminary solutions.

Eq. (3) is recommended in /6/ for the long term analysis of R.C. and P.C. structures, nevertheless no indications are given about the most convenient way for applying it to typical problems of engineering practice. Furtherly no consideration is made about the reliability levels reached when using eq. (3). These two basic aspects will be discussed in the next section.

3. Algebraic approach to long term structural analysis

R.C. and P.C. structures can be regarded as homogeneous viscoelastic structures elastically restrained, so, indicating by $\underline{X}(t)$ the vector of the redundant elastic restraints, the application of eq. (3) drives to the following compatibility system of algebraic equations

$$[\underline{E}_c(t_0) (1 + \chi\varphi) + \underline{E}_s] \underline{X} + \underline{E}_c(t_0) \varphi(1 - \chi) \underline{X}_0 = -\underline{\delta}_g(1 + \chi\varphi) - \underline{\delta}_{0g}\varphi(1 - \chi) - \bar{\underline{\delta}} \quad (5)$$

where $\underline{E}_c(t_0)$, \underline{E}_s are the elastic deformability matrices of the viscoelastic part and of the elastic restraints and $\underline{\delta}_g$, $\bar{\underline{\delta}}$ are the vectors of the relative displacements produced by external loads and imposed deformations. At initial time $\varphi = 0$, so eq. (5) becomes



$$[\underline{E}_c(t_0) + \underline{E}_s] \underline{X}_0 = -\underline{\delta}_{0g} - \bar{\underline{\delta}}_0 \quad (6)$$

Combining eqs. (5), (6) we finally obtain

$$[\underline{E}_c(t_0)(1+\chi\varphi) + \underline{E}_s] \underline{X} = -\underline{\delta}_g(1+\chi\varphi) - \underline{\delta}_{0g}\varphi(1-\chi) - \bar{\underline{\delta}} + \underline{E}_c(t_0)[\underline{E}_c(t_0) + \underline{E}_s]^{-1} \cdot [\underline{\delta}_{0g} + \bar{\underline{\delta}}_0] \cdot \varphi(1-\chi) \quad (7)$$

Applying the principle of superposition the solution of the algebraic system (7) can be expressed in the following form

$$\underline{X} = \underline{X}_1 + \underline{X}_2 \quad (8)$$

with \underline{X}_1 , \underline{X}_2 partial solutions satisfying the subsequent systems

$$[\underline{E}_c(t_0) (1+\chi\varphi) + \underline{E}_s] \underline{X}_1 = -\underline{\delta}_g(1+\chi\varphi) - \bar{\underline{\delta}} \quad (9)$$

$$[\underline{E}_c(t_0) (1+\chi\varphi) + \underline{E}_s] \underline{X}_2 = \varphi(1-\chi) \{ -\underline{\delta}_{0g} + \underline{E}_c(t_0) [\underline{E}_c(t_0) + \underline{E}_s]^{-1} \cdot [\underline{\delta}_{0g} + \bar{\underline{\delta}}_0] \} \quad (10)$$

It is immediate to observe that the solution of system (9) is very simple as it coincides with the elastic one assuming for concrete the varied modulus $E' = E_c(t_0)/(1+\chi\varphi)$. On the contrary the solution of eq. (10) is quite involved as the known term at right member has to be calculated in advance and cannot be directly introduced in a standard computer program for structural analysis. For this reason the algebraic form (3) of the creep constitutive law cannot be directly incorporated in a Model Code Format. By means of a basic theorem, recently proven /7/ /8/, eq. (10) can be reduced to a very simple form leading to a general solution obtained by solving three elastic problems using standard computer programs. As will be shown in detail in the following, this allows to consistently incorporate the algebraic form (3) in a Model Code Format.

4. The basic theorem governing long term algebraic structural analysis

Let us consider eqs. (9) (10). As previously said eq. (9) can be solved by means of an elastic analysis performed at time t , assuming for concrete the varied modulus E' . Regarding eq. (10), according to eq. (5), we write it in the following form

$$[\underline{E}_c(t_0) (1+\chi\varphi) + \underline{E}_s] \underline{X}_2 = -\underline{\delta}_{0g} \varphi(1-\chi) - \underline{E}_c(t_0) \varphi(1-\chi) \underline{X}_0 \quad (11)$$

For the solution of eq. (11) we assume the subsequent expression

$$\underline{X}_2 = \underline{X}' + \mu \underline{X}_0 \quad (12)$$

with \underline{X}' unknown vector and μ unknown coefficient depending on t , t_0 . Substituting eq. (12) in eq. (11) we obtain

$$[\underline{E}_c(t_0) (1+\chi\varphi) + \underline{E}_s] (\underline{X}' + \mu \underline{X}_0) = -\underline{\delta}_{0g} \varphi(1-\chi) - \underline{E}_c(t_0) \varphi(1-\chi) \underline{X}_0 \quad (13)$$

adding and subtracting at second member the quantity $\mu[\underline{\delta}_{0g}(1+\chi\varphi) + \bar{\underline{\delta}}_0]$, we see that eq. (13) can be splitted in the two following systems

$$[\underline{E}_c(t_0) (1+\chi\varphi) + \underline{E}_s] \underline{X}' = \mu[\underline{\delta}_{0g} (1+\chi\varphi) + \bar{\underline{\delta}}_0] \quad (14)$$

$$[\underline{E}_c(t_0)\underline{X}_0 + \underline{\delta}_{0g}] [\mu\chi\varphi + \varphi(1-\chi)] = \underline{0} \quad (15)$$

Indicating by \underline{X}_{10} the elastic solution obtained assuming the initial values of the applied actions and concrete modulus E' , the solution of eq. (14) can be immediately written in the following form

$$\underline{X}' = -\mu \underline{X}_{10} \quad (16)$$

Regarding eq. (15), we derive that it is satisfied when assuming for μ the following expression (17)

Consequently, the general solution of eq. (5) can be put in the following compact form

$$\underline{X} = \underline{X}_1 + \mu(\underline{X}_0 - \underline{X}_{10}) \quad (18)$$

In particular, for actions constant in time we have $X_1 = X_{10}$, so eq. (18) assumes the simpler form

$$\underline{X} = \underline{X}_1(1-\mu) + \mu\underline{X}_0 \quad (19)$$

The two relationships (18) or (19) together with eq. (17) allow to reduce the long term analysis of concrete structures to the superposition of three elastic analyses so that they can be easily incorporated in a Code Format.

5. Applications and worked examples

By means of the first numerical application we want to investigate about the accuracy of eqs. (18) (19). At this scope let us consider the basic problem regarding the calculation of the evolution in time of the state of stress in the prestressed tie of fig. 2.

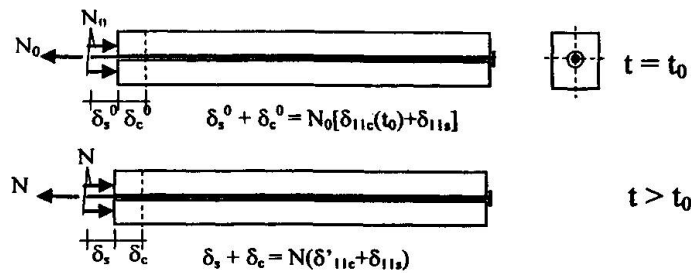

Fig.2 Prestressed tie

Indicating by N_0 the initial prestressing force and by N the prestressing force at time t , the exact solution of the problem is obtained by solving the following integral equation

$$\int_0^t dN(t') (\delta_{11c}(t_0) \cdot E_c(t_0) J(t,t') + \delta_{11s}) = N_0 (\delta_{11c}(t_0) + \delta_{11s}) \quad (20)$$

with $\delta_{11c}(t_0) = 1/(E_c(t_0)A_c)$, $\delta_{11s} = 1/(E_sA_s)$

Introducing the coupling coefficient

$$\omega = \delta_{11c}(t_0)/(\delta_{11c}(t_0) + \delta_{11s}) = (1+1/(n\rho_s))^{-1} \quad n = E_s/E_c(t_0), \rho_s = A_s/A_c \quad (21)$$

and putting $\xi_N(t) = N(t)/N_0$, from eq. (20) we derive

$$\int_0^t d\xi_N(t') [\omega E_c(t_0) J(t,t') + 1 - \omega] = 1 \quad (22)$$

Applying the approximate form (19) we on the contrary obtain

$$N_1(\delta_{11c}(t_0) (1+\chi\varphi) + \delta_{11s}) = N_0(\delta_{11c}(t_0) + \delta_{11s}) \quad (23)$$

and remembering eq. (21), for the ratio $\xi_{1N} = N_1/N_0$ we write

$$\xi_{1N} = 1/(1 + \chi\omega\varphi) \quad (24)$$

At initial time $N(t_0) = N_0$, $\xi_{0N} = 1$, so eq. (19) gives



$$\xi_N = \xi_{IN}(1 - \mu) + \mu\xi_{ON} = (1 + \mu\chi\omega\varphi)/(1 + \chi\omega\varphi) \quad (25)$$

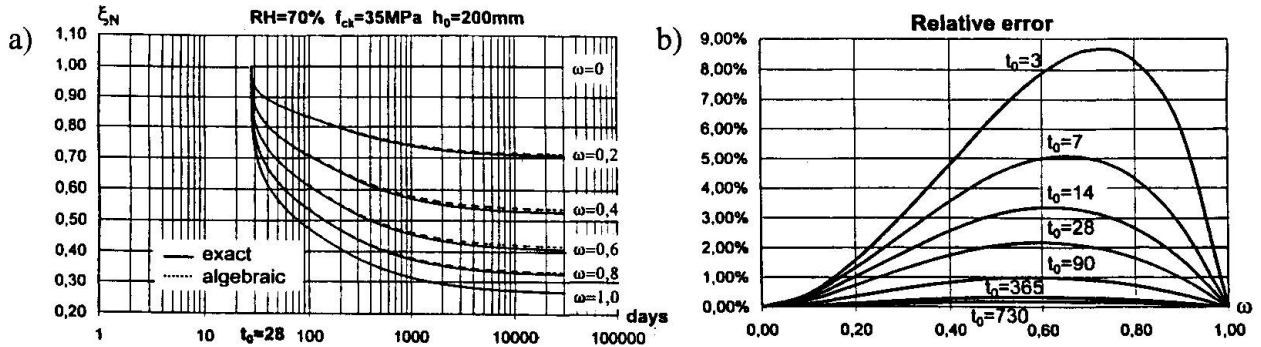

Fig. 3 a) Function $\xi_N(t, t_0)$, b) Relative error between exact and approximate solution of eq. (22)

In fig. 3a) the exact solution of eq. (22) and the approximate one given by eq. (25) are reported versus time assuming ω as parameter. The high accuracy of eq. (25) is quite evident and this is emphasized by the graphs of fig. 3b) representing the relative error between the two solutions for $t \rightarrow \infty$ assuming ω as independent variable. The relative error does not exceed 9% and for prestressed elements, connected to small values of ω ($\omega \leq 0,08 \div 0,10$), the error is lesser than 2%. The algebraic approach stands very reliable for the analysis of prestressed elements so we can try to derive a feasible Code – Format design formula of general purpose. At this scope let us consider the prestressed section of fig. 4, subjected to an initial prestressing force N_0 , a permanent bending moment M_g and shrinkage deformation ε_{cs} . Applying eq. (19) and the superposition principle we see that the prestressing force varies according to eq. (25) when introducing for the parameter ω the following more general expression

$$\omega = (1 + e^2/r^2)/(1 + e^2/r^2 + 1/n\rho_s) \quad (26)$$

where e is the eccentricity of the cable and r is the gyration radius of the section. Regarding M_g and ε_{cs} , they do not produce stresses in the cable at initial time so we have only to calculate the related effects at time t by means of the two following relationships

$$N_{1g}(\delta'_{11c} + \delta_{11s}) = M_g e \varphi / (E_c(t_0) A_c r^2) \quad N_{1cs}(\delta'_{11c} + \delta_{11s}) = \varepsilon_{cs} \quad (27)$$

Remembering that $\delta_{11c}(t_0) = (1 + e^2/r^2)/(E_c(t_0) A_c)$ and introducing the following quantities

$$c = e^2/r^2, \quad \alpha_g = M_g/N_0 e, \quad \alpha_{cs} = \varepsilon_{cs} E_c(t_0) A_c/N_0 \quad (28)$$

the superposition of ξ_N given by eq. (25) and of the solutions of eqs. (27), according to eq. (19) gives the following general design formula

$$N = N_0 [1 + \mu\chi\omega\varphi + \alpha_g\omega c\varphi/(1+c) + \alpha_{cs}\omega/(1+c)]/(1 + \chi\omega\varphi) \quad (29)$$

Eq. (29) allows to obtain by means of simple calculations the final state of stress in the prestressing cable taking into account the mutually interacting effects connected to prestressing, external loads and shrinkage.

Introducing the numerical values of fig. 4 we immediately obtain

$$N/N_0 = (1 - 0,43 \cdot 0,7 - 0,063 \cdot 2,6 + 0,707 \cdot 0,063 \cdot 0,595 \cdot 2,6 - 1,99 \cdot 0,063/2,467)/(1 + 0,7 \cdot 0,063 \cdot 2,6) = 0,853 + 0,062 - 0,046 = 0,87$$

We see that the total reduction of the initial stress is 13%. This value derives from the superposition of three contributions, namely a reduction of 14,7% connected to prestressing, an increase of 6,2% due to external load and a decrease of 4,6% due to shrinkage. Eq. (29) exhibits simplicity in use, detailed quantification of the various effects and high accuracy. Remembering

that it derives from the superposition of simple elastic calculations we can conclude that it can be recommended as reliable Model Code Format design formula of general use for long term analysis of prestressed sections.

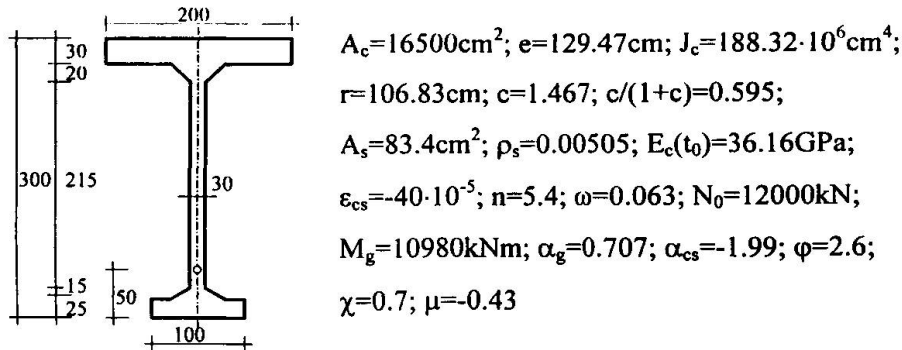

Fig. 4 Prestressed post-tensioned section

6. Conclusion

The algebraic approach to long term structural analysis of concrete structures drives to feasible Code Format solutions when applied in the form allowing to consider in an indirect way the effect of the initial deformation. The proposed procedure, requiring to superimpose three elastic solutions obtained referring to the actual modulus of concrete or to a reduced value of it, does not introduce the initial deformation as an imposed one, so it can be easily operated recurring to usual computer programs dealing with elastic analysis. Further works devoted to the analysis of more complex systems have to be programmed in order to extended the basic principles now discussed, allowing the practitioner to approach in a rational and reliable way the long term structural analysis of concrete structures. In particular the analysis of structures incorporating two rheologically nonhomogeneous concrete parts and elastic parts like precast beams collaborating with cast in situ slabs is of significant interest.

7. References

- /1/ CEB – FIP, Model Code 1990, Design Code, Thomas Telford, London, UK, 1993.
- /2/ ACI Committee 209 “Prediction of Creep, Shrinkage and Temperature Effects in Concrete and Structures” 209R-92, ACI, Detroit USA, 1992.
- /3/ “Structural Effects of time dependent behaviour of concrete”, CEB Bulletin d’Information n° 215, Lausanne, CH, 1993.
- /4/ Mc Henry, D., “A New Aspect of Creep in Concrete and its Application to Design”, Proc. ASTM, n. 43, 1943.
- /5/ Trost, H., “Auswirkungen des Superpositionprinzips auf Kriech und Relaxation Probleme bei Beton und Spannbeton”, Beton und Stahlbetonbau, H. 62, 1967.
- /6/ EUROCODE 2 “Design of Concrete Structures”, Part 1, General Rules and Rules for Buildings.
- /7/ Mola, F., “Long term Analysis of Slender R.C. Frames”, Symposium on Advanced Design of Concrete Structures, Goteborg, S, 1997.
- /8/ Mola, F., Gatti, M.C., “Long term Analysis of Prestressed Continuous Composite Steel – Concrete Members”, Proceedings of Structural Engineering World Congress (SEWC), S. Francisco USA, 1998.

Acknowledgment

The author wishes to thank his former student Dr. Eng. Gabriele Meda for his support in preparing the present manuscript. Dr. Meda work in developing the numerical calculations of the worked examples is highly appreciated.



Effect of Confinement on Reinforced Concrete Columns Subjected to Eccentric Loading

Chai Jaturapitakkul
Assistant Professor
KMUT Thonburi
Bangkok, Thailand



Kraiwood Kiattikomol
Associate Professor
KMUT Thonburi
Bangkok, Thailand



Somchai Chucheepsakul
Professor
KMUT Thonburi
Bangkok, Thailand



Anek Siripanichgorn
Assistant Professor
KMUT Thonburi
Bangkok, Thailand



Summary

In this experimental study, total number of 48 reinforced concrete columns with and without confinement under eccentric loading were conducted. For confined columns, transverse reinforcement was provided by tie with spacing of 5, 10, and 20 cm. Columns having the same confinement were tested under a compressive load with the eccentricity of 0, 3, 6, and 9 cm from the center-line of the cross section.

The results revealed that the columns with confinement can resist higher load than the one without confinement and the columns with smaller tie spacing give higher ultimate loads as well as larger lateral deflections than the ones with larger tie spacing. For columns under the same eccentricity, ties with smaller spacing have shown to be more effective in increasing the ultimate load of column than the ones with larger spacing. Finally, confinement also makes concrete column more ductile and has higher lateral deflection when subjected to the same loading.

1. Introduction

In designing reinforced concrete columns, the amount of main steel is calculated based on the loading and the strengths of steel and concrete. However, the amount of transverse reinforcement, either tie or spiral, was recommended by the requirement of code, for example, ACI 318 [1] specified that the spacing of tie shall not exceed 16 longitudinal bar diameters, 48 tie bar or the least dimension of column. When the concrete column was subjected to loading, it would be shortened in the longitudinal direction as well as expanded in the lateral direction. The use of transverse reinforcement reduces the hoop stress in the column, thus increases the capacity of column and makes it more ductile as compared to the one without confinement [2,3]. For high strength concrete column, the failure of column without confinement was suddenly occurred and dangerous. The use of transverse reinforcement as well as the higher amount of main bars made concrete column more ductile [4]. The rate of loading also affected

the behavior of concrete column. In case of plain concrete columns, the ones with very fast rate of loading failed suddenly like an explosion and took 35% higher load than the ones with medium rate of loading. The column with confinement was found to resist higher load and had more ductility for every rate of loading [5].

Many researchers [2-7] showed that the use of transverse reinforcement would increase the capacity and ductility of column. However, in all of the aforementioned works, the emphases were placed on columns subjected to concentric loading, a few works considered on one eccentricity. [3,6]. To cover the behavior of reinforced concrete columns under loading, the experimental program for columns with different tie spacings subjected to different eccentricities of loading were tested and studied.

2. Objective

The objective of this research was to investigate the behavior of short reinforced concrete columns with different tie spacings under eccentric and concentric loadings. The experimental and analytical results were compared and discussed.

3. Experimental Program

3.1 Reinforced Concrete Columns

Concrete columns with cross section of $20 \times 30 \text{ cm}^2$ and 120 cm in height with 6- $\varnothing 12$ mm main bars were cast. For confined columns, transverse confinement was provided by tie of $\varnothing 6$ mm with spacing of 5, 10, and 20 cm. After 28 days, the total 48 columns were tested with the varying eccentricities of 0, 3, 6, and 9 cm from the centerline of the cross section. For each eccentricity, 3 columns were tested. Fig. 1 shows the detail of tested columns

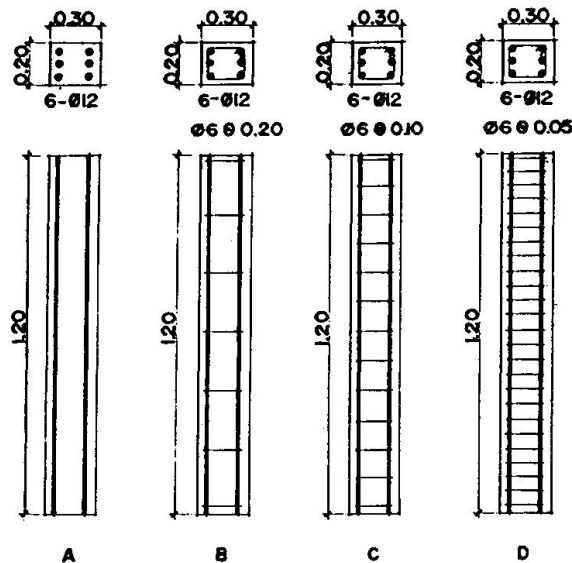

Fig. 1 Detail of main and tie bars of reinforced concrete columns

3.2 Testing of Concrete Columns

The procedure to test concrete columns can be described as follows:

-Place the column on a 200-ton universal testing machine. On the top and bottom faces of the column, a 1-inch thickness of steel plate was placed to transfer the applied load through the column as shown in Fig. 2.

-Dial gauge "a" was used to measure the shortening of column with gauge length of 100 cm. Dial gauges "b", "c", and "d" were placed at 10, 60, and 110 cm, respectively, from the top



of column in order to measure the lateral deflection due to eccentricity of loading. The schematic setting for column testing is shown in Fig. 3.

-Apply a uniform rate 4000 kg/minute of loading and record the shortening, lateral deflection of column for every incremental load of 5000 kg until the column was failed.

-D, C, B, and A were designated to those columns with ties spacing of 5, 10, 20 cm, and without tie, respectively. For columns A0, A3, A6, and A9, the suffix meant the eccentricity of loading and was 0, 3, 6, and 9 cm, respectively. This was also applied to columns with designation B, C, and D.

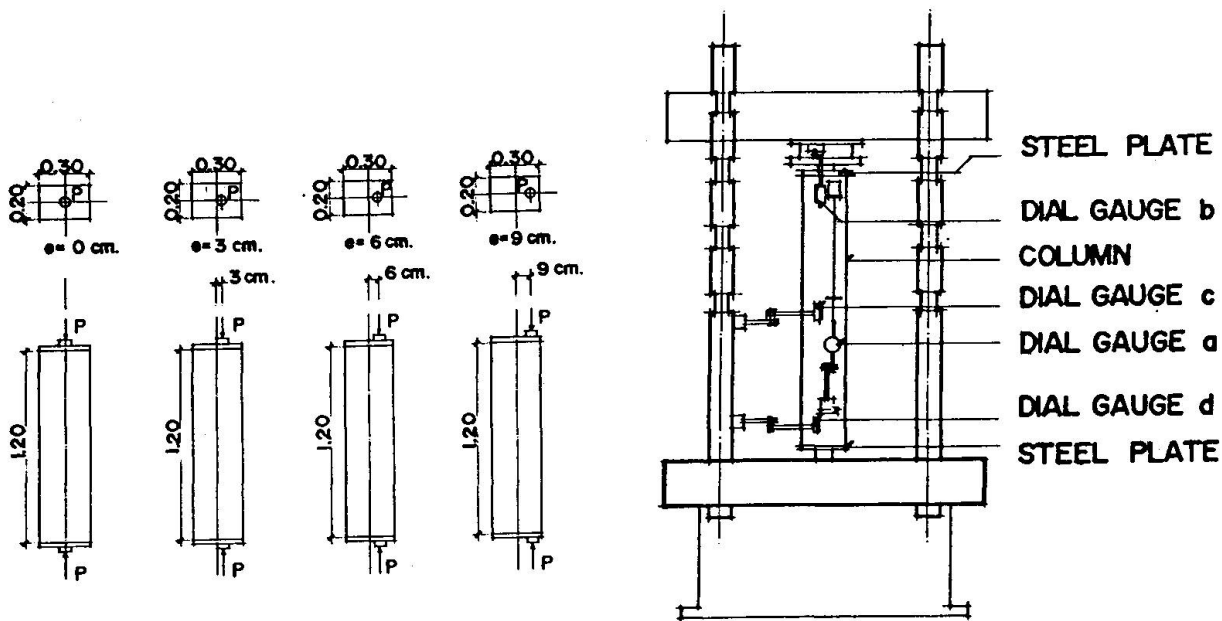

Fig. 2 Detail of column under eccentric loading Fig.3 Schematic setting for column testing

4. Results and Discussions

4.1 Properties of Concrete and Steel

The average compressive strength of standard cylinder at 28 days was 101.2 kg/cm^2 . The main and tie bars had yield strengths of 2884 and 2888 kg/cm^2 , and the elastic moduli were 2.177×10^6 and $2.132 \times 10^6 \text{ kg/cm}^2$, respectively.

4.2 Effect of Confinement on the Capacity of Columns

Table 1 shows the capacity of columns in resisting load. With confinement, the concrete columns resisted higher ultimate load than the ones without confinement. These results confirm to those obtained by other researchers [2,3,6,7]. With the same confinement, the columns tended to take less load as the eccentricity was increased. This is due to the failure of column caused by the combination of compression and bending. According to ACI code [1], the tested column should have tie spacing of 20 cm. It was found that the column with 20 cm tie spacing resisted 11.79% higher load than the one without tie, but 6.64 and 12.64% lower than the ones with tie spacing of 10 and 5 cm, respectively.

The use of confinement is more effective for column subjected to eccentric loading than the one subjected to concentric loading. With eccentricity of 3 cm, the ultimate loads of column were 80.75, 74.2, 64.52, and 55.3 tons for columns with ties of spacing 5, 10, 20 cm, and without tie, respectively or increasing of 46.02, 34.17, and 16.67% as compared to the ones without tie. At the same value of eccentricity, ties with smaller spacing have shown to be more effective in increasing the ultimate load of column than the ones with larger spacing.

Table 1 Strength of concrete columns under eccentric loading

Column No.	Tie Spacing (cm)	Eccen. (cm)	P _u (Exp.) (tons)	Load Increasing Compared to Column without Tie Bar (%)	Load Increasing Compared to Column with 20 cm Spacing (%)	Lateral Deflection at Mid-height (mm)
A0	-	0	64.78	-	-11.79	1.78
B0	20	0	73.44	13.36	-	2.97
C0	10	0	78.32	20.90	6.64	5.08
D0	5	0	82.73	27.69	12.64	4.72
A3	-	3	55.30	-	-14.29	1.95
B3	20	3	64.52	16.67	-	2.01
C3	10	3	74.20	34.17	15.00	2.08
D3	5	3	80.75	46.02	25.16	3.14
A6	-	6	47.70	-	-20.84	0.94
B6	20	6	60.27	26.33	-	1.52
C6	10	6	66.48	39.35	10.31	2.46
D6	5	6	70.76	48.31	17.40	3.57
A9	-	9	43.17	-	-24.28	1.01
B9	20	9	57.01	32.07	-	1.52
C9	10	9	62.54	44.86	9.70	2.21
D9	5	9	63.61	47.34	11.58	2.61

4.3 Ultimate Load of Columns from Experimental and Analytical Results

Following the procedures given in [8], the capacity of short reinforced concrete column can be calculated and the numerical example can be found in [9]. Table 2 shows the ultimate loads of columns from experimental and analytical results. It is seen that the capacities of columns without confinement from experiment are in good agreement with the analytical results. In case of column under eccentric loading, the ultimate load of column increases with the increase of confinement. For example, the column with eccentricity of 9 cm, and tie spacing of 20, 10, and 5 cm, the capacity of column is increased by 45.77, 59.91, and 62.64%, respectively, as compared to the one without confinement (by analytical result).

4.4 Relationship between Load and Strain of Columns

Relationships between load and strain of the tested columns are shown in Figs. 3 to 7. The strain of column in this experiment is caused by the combine action of compression and bending



moment due to eccentricity. At the same eccentricity, it was found that column with smaller spacing of tie gave higher ultimate load as well as higher ultimate strain before failure. This is due to the ties confining the core of concrete and making the core stronger than the one without or with lesser ties. At the same eccentricity and loading, column A (without tie) had higher strain than the other columns. It could be suggested that confinement increase the ductility as well as the capacity of column without increasing the amount of main bar.

4.5 Relationship between Load and Lateral Deflection of Columns

Relationships between load and lateral deflection of columns under different eccentricities of loading are shown in Figs. 8 to 11. At the same loading and eccentricity, the column with smaller spacing of tie had higher lateral deflection than the ones with larger spacing. In addition, the column with more confinement had higher deflection, and also obtained higher ultimate load at failure than the ones with less confinement. For example, in Fig. 11, at loading of 40 tons with eccentricity of 9 cm, column A9 (without tie bar) had lateral deflection of 0.54 mm while column D9 (tie spacing of 5 cm) had lateral deflection of 1.55 mm or three times higher. At the ultimate load, column A9 had load of 43.17 tons with the corresponding lateral deflection of 1.013 mm while column D9 yielded loading of 63.61 tons with the lateral deflection of 2.613 mm. Thus, the confinement can improve the ultimate load capacity as well as provide the ductility of concrete column, especially for column under eccentric loading.

Table 2 Ultimate load of concrete columns from experimental and analytical results

column No.	Tie Spacing (cm)	Eccentricity (cm)	P_u (Exp.) (tons)	P_u (Ana.) (tons)	P_u (Ana.) – P_u (Exp.)	
					(tons)	(%)
A0	-	0	64.78	70.60	-5.82	-8.24
A3	-	3	55.30	57.40	-2.10	-3.66
A6	-	6	47.70	47.13	+0.57	+1.21
A9	-	9	43.17	39.11	+4.06	+10.38
B0	20	0	73.43	70.60	+2.83	+4.01
B3	20	3	64.52	57.40	+7.12	+12.40
B6	20	6	60.27	47.13	+13.14	+27.88
B9	20	9	57.01	39.11	+17.90	+45.77
C0	10	0	78.32	70.60	+7.72	+10.93
C3	10	3	74.20	57.40	+16.80	+29.27
C6	10	6	66.48	47.13	+19.35	+41.06
C9	10	9	62.54	39.11	+23.43	+59.91
D0	5	0	82.73	70.60	+12.13	+17.18
D3	5	3	80.75	57.40	+23.35	+40.68
D6	5	6	70.76	47.13	+23.63	+50.14
D9	5	9	63.61	39.11	+24.50	+62.64

NO ECCENTRICITY

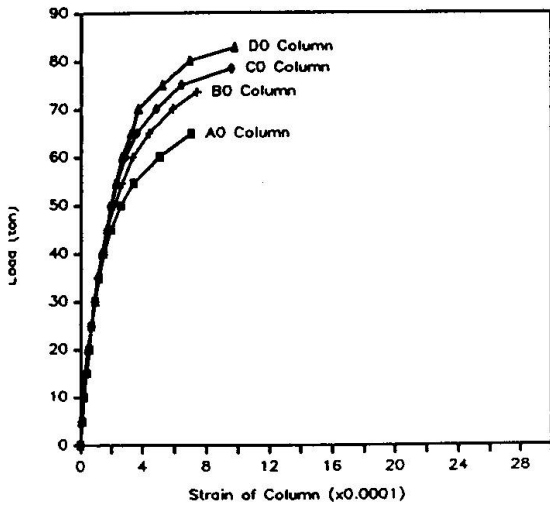

Fig. 4 Relationship between load and strain of columns under concentric loading

ECCENTRICITY = 3 cm

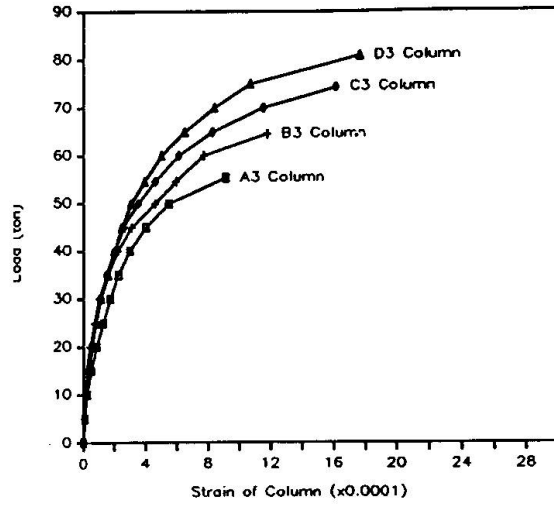

Fig. 5 Relationship between load and strain of columns under eccentricity of 3 cm

ECCENTRICITY = 6 cm

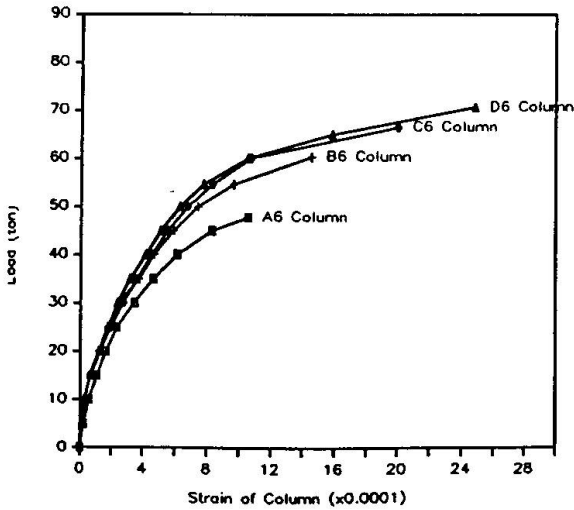

Fig. 6 Relationship between load and strain of columns under eccentricity of 6 cm

ECCENTRICITY = 9 cm

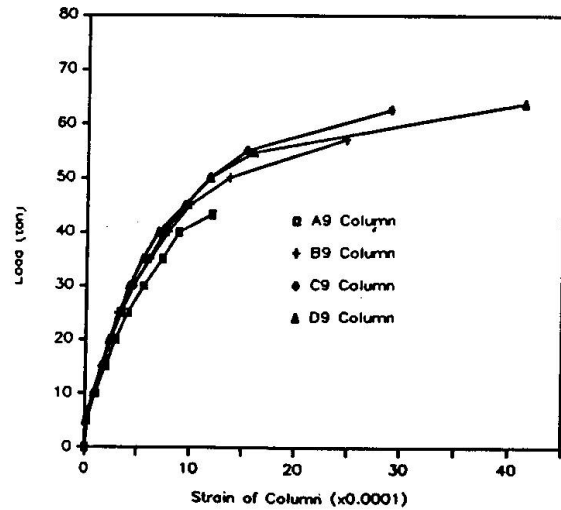

Fig. 7 Relationship between load and strain of columns under eccentricity of 9 cm

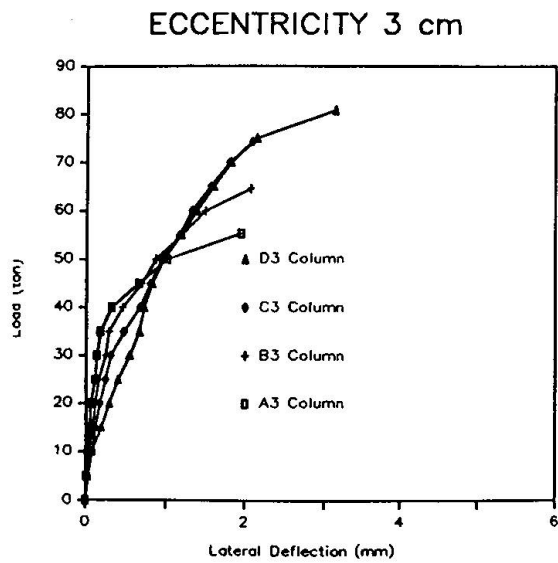

Fig. 8 Relationship between load and deflection of columns under concentric loading

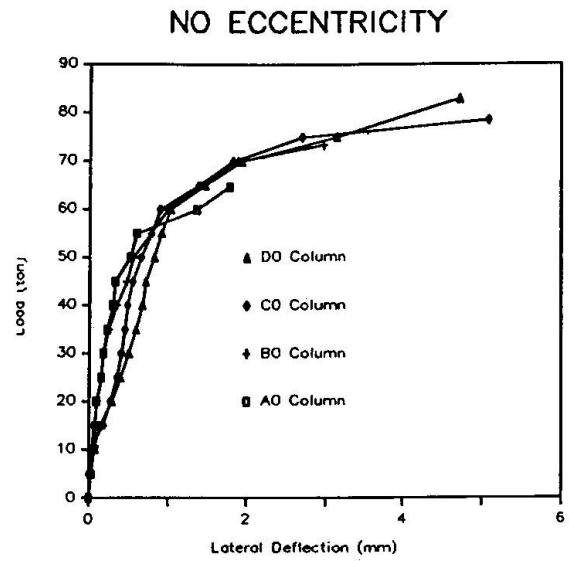

Fig.9 Relationship between load and deflection of columns under eccentricity of 3 cm

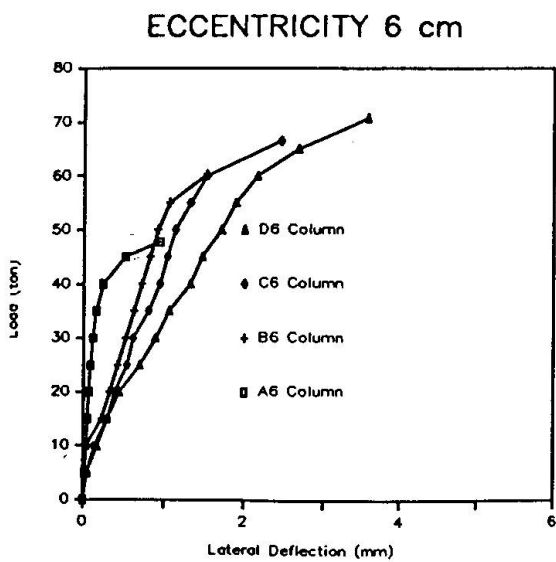

Fig. 10 Relationship between load and deflection of columns under eccentricity of 6 cm

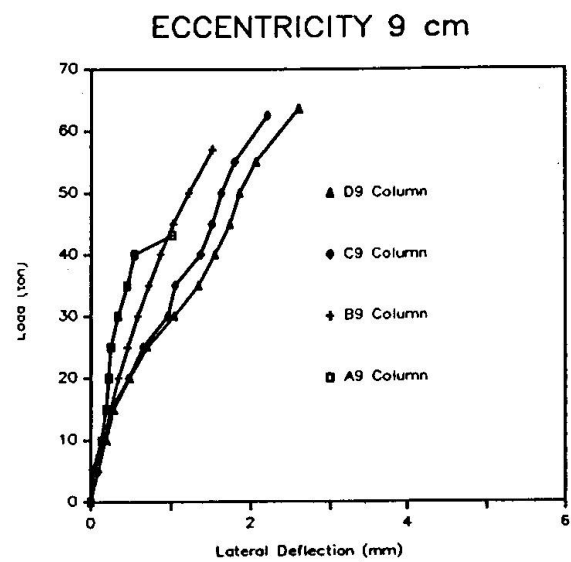

Fig.11 Relationship between load and deflection of columns under eccentricity of 9 cm

5. Conclusions

From this study, the conclusions can be drawn as follows:

1. Columns with smaller tie spacing resist higher ultimate loads than the ones with larger tie spacing.
2. Column under the same loading and eccentricity, closer tie spacing tended to give larger lateral deflection.
3. For columns under the same eccentricity, ties with smaller spacing have shown to be more effective in increasing the ultimate load of column than the ones with larger spacing.

6. Acknowledgement

The authors would like to thank the National Research Council of Thailand for providing financial support through the research grant to King Mongkut's University of Technology Thonburi. Many thanks are also extended to Mr. Boonchai C., Mr. Salaruk S., Mr. Surasak T., and Mr. Surasak N. for their efforts on preparing and testing the concrete columns.

7. References

1. ACI 318-89, 1992, "Building Code Requirements for Reinforced Concrete," *ACI Manual of Concrete Practice Part 3-1992*, American Concrete Institute.
2. Iyengar K. T. S. R., Desayi, P., and Reddy K.N., 1970, "Stress-Strain Characteristics of Concrete Confined in Steel Binders," *Mag. of Concr. Res.*, V. 22, No. 72, pp. 173-184.
3. Soliman, M. T. M. and Yu, C.W., 1967, "The Flexural Stress-Strain Relationship of Concrete Confined by Rectangular Transverse Reinforcement," *Mag. of Concr. Res.*, V. 19, No. 61, pp. 223-238.
4. Yong, Y. K., Nour, M. G., and Navy, E. G., 1988, "Behavior of Laterally Confined High-Strength Concrete Under Axial Loads," *J. of Str. Eng.*, V. 114, No. 2, pp. 332-351.
5. Dilger, W.H., Koch, R., and Kowalczyk, R., 1984, "Ductility of Plain and Confined Concrete Under Different Strain Rates," *J. of Amer. Concr. Inst.*, V. 81, No. 1, pp. 73-81.
6. Sargin, M., Ghosh, S.K., Handa, V.K., 1971, "Effects of Lateral Reinforcement Upon the Strength and Deformation Properties of Concrete," *Mag. of Concr. Res.*, V. 23, No. 75-76, pp. 99-110.
7. Gangadharam, D. and Reddy K.N., 1980, "Effect of Cover Upon the Stress-Strain Properties of Concrete Confined in Steel Binders," *Mag. of Concr. Res.*, V. 32, No. 112, pp. 147-155.
8. Nilson, A.H. and Winter, G. 1991, *Design of Concrete Structures*, 11th Edn., McGraw-Hill, pp. 284-295.
9. Jaturapitakkul, C., Kiattikomol, K., Chuchepkskul, S., and Siripanichgorn, A., 1997, "Effect of Confinement on Reinforced Concrete Columns", *Final Research Report to the National Research Council of Thailand*, King Mongkut's Institute of Technology Thonburi, 37 pp.



Accuracy of Design of Concrete Structures

Guenter ROMBACH
Professor Dr.-Ing.
Technical University of
Hamburg-Harburg
Denickestr. 17
D-21073 Hamburg
Germany



Prof. Dr.-Ing. Günter Rombach, born 1957, graduated at the University of Karlsruhe as a civil engineer, where he also obtained his doctoral degree. In 1990 he joined the Bilfinger + Berger Company where he worked as a structural engineer. In 1995 he became technical manager for the Second Stage Expressway System in Bangkok. Since 1996 he is Professor of Concrete Structures at the Technical University of Hamburg-Harburg

Summary

The volume of Standards and Codes for design of concrete structures is constantly increasing (e.g. Eurocode 2, DIN 1045-1 draft revision 1998). The prescribed methods for analysis of reinforced or prestressed concrete members are getting more and more sophisticated. Nevertheless due to the great scatter of material properties in practice and the uncertainty of actions the design of concrete structures is of limited accuracy. This has to be considered in Standards. The limitations of accuracy in concrete design are mentioned in this paper.

1. Introduction

Europe and especially Germany has a long tradition with Standards. The first German Code for design of concrete structures was issued in 1925. It was constantly revised during the following years. The new Code DIN 1045-1 [1] which is mainly based on the Eurocode 2 part 1 [2] (referred as EC2 in this paper) will be published in 1999. It includes major changes like e. g. a probabilistic safety concept which requires a more complex definition of actions, limit states theory and some new verifications. It is without doubt that the amount of required analysis will be increased. The purpose of the new code is to improve the safety and durability of concrete structures. However the failures and damages which occurred in the past are mainly caused by bad workmanship or faulty design rather than by simplified Codes. For the design of concrete structures several assumptions and simplifications are required which limits the accuracy of the design. This can not be overcome by complex models.

The design of a concrete structure is based on assumptions regarding the material behaviour resp. material properties, actions, structural model and structural analysis. These items are briefly discussed in the following.

2. Material Properties and Material Models

The knowledge of the behaviour of building materials has made a great progress in the last decades. In addition the quality of concrete and steel has been improved. Nevertheless reinforced concrete is a very inhomogeneous material. It's material parameters are highly dependent from several factors like e. g. cement type, water/cement ratio, strength and size of aggregate, admixtures which vary in a certain range. Furthermore the condition during hardening (e.g. temperature, humidity, loading) highly influences the quality and the time dependent behaviour of concrete structures. The workmanship and the environmental conditions are only roughly known when the structure is designed. Therefore all material properties given in Codes can only be a rough approximation of the reality. Furthermore it should be kept in mind that all material properties are obtained by experiments on small specimens (e.g. concrete cylinders). It has to be considered that the behaviour of concrete in experiments may be different from that of real structures.

Stress - strain diagrams of concrete

The section design of a member is mainly based on the stress-strain diagram of concrete. Eurocode 2-1 provides three alternative diagrams, one for structural analysis and 2 for cross-section design.

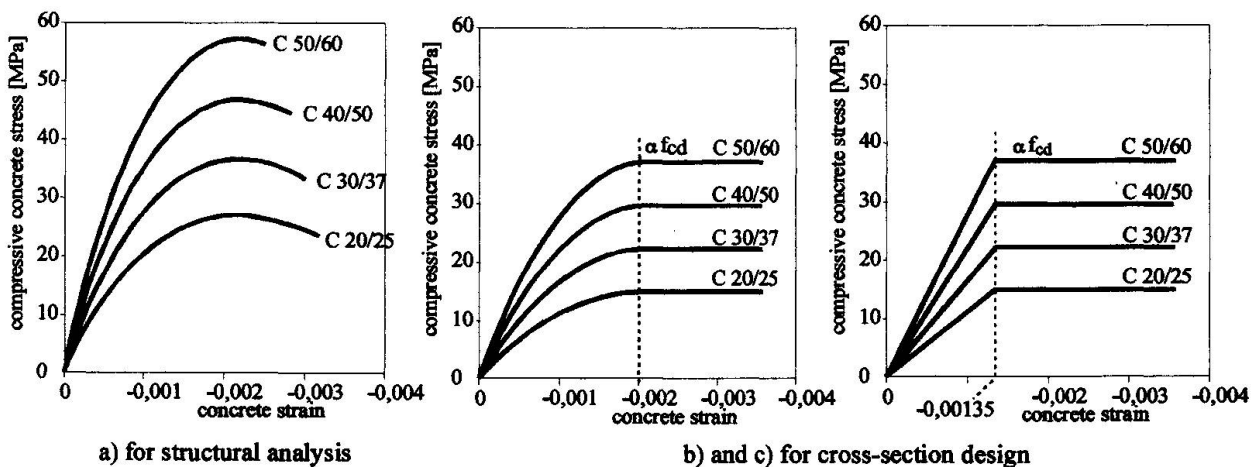

Figure 1 Stress-Strain Diagrams of Concrete according to EC2

All these curves are idealisations of the real behaviour of plain concrete. The reduction factor α which may be assumed to be 0,85 should take into account e. g. long term and size effects. But it should also allow for approximations in the calculations and variations of material properties.

Shrinkage and creep

For normal reinforced structures the influence of shrinkage and creep may be neglected whereas for prestressed constructions it has to be considered in the design. EC2 provides with a detailed method for the calculation of creep coefficients $\varphi(t, t_0)$ and shrinkage strains ϵ_s . (for details see EC2-1, appendix 1).

Creep coefficient: $\varphi(t, t_0) = \varphi_0 \cdot \beta_c(t - t_0) = \varphi_{RH} \cdot \beta(f_{cm}) \cdot \beta(t_0) \cdot \beta_c(t - t_0)$ (EC2, eq. A1.1/1.2)

with: $\varphi_{RH} = 1 + \frac{1 - RH / 100}{0.10 \cdot \sqrt[3]{h_0}}$; $\beta(f_{cm}) = \frac{168}{\sqrt{f_{cm}}} = \frac{168}{\sqrt{f_{ct} + 8N / \text{mm}^2}}$; $\beta(t_0) = \frac{1}{0,1 + t_0^{0,20}}$; $h_0 = \frac{2 \cdot A_c}{u}$



$$\beta_c(t-t_0) = \left(\frac{t-t_0}{\beta_H + t-t_0} \right)^{0.3}; \quad \beta_H = 1.5 \cdot [1 + (0.012 \cdot RH)^{18}] \cdot h_0 + 250 \leq 1500; \quad t_0 = t_{0,T} \cdot [9 / (2 + t_{0,T}^{1.2}) + 1]^{\alpha} \geq 0.5$$

The complexity of the various equations may deceive the designer with a high accuracy. But there still is a significant difference between experiment and real structures. It should be kept in mind that all input variables are only roughly known during the design stage. Next the time dependent behaviour of concrete structures usually is calculated in a simplified manner, e. g. loss of prestressing force (EC2, eq. 4.10) or redistribution of moments in a continuous beam.

3. Actions

A structure is subjected to permanent, variable and accidental actions like e. g. dead load of the structure, superimposed dead load, wind load, snow load, traffic loads, temperature loads etc. Only the dead load is quite well known during the design stage. All over loads can only be estimated with a rather limited accuracy. This becomes especially true for actions which vary in time and space like e. g. wind loads. A lot of research work has been done in the past on this item leading to more detailed load arrangements. But it should be clear that the designer doesn't need the 'accurate' loads. For the design the worst case and a simple arrangement of forces is required.

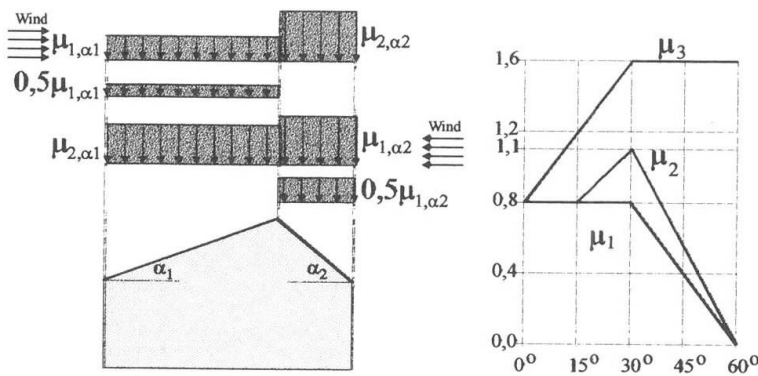

This may be illustrated by the following example: snow loads. In the past, only a constant load had to be considered in the design of buildings in Germany. The new EC 1 part 7 [4] requires 4 different load cases. This arrangement of loads is more realistic than a constant load. But does it lead to an increase in safety?

Figure 2 Snow loads according to Eurocode 1 part 7

4. Safety Format - Load Combination

The design of a structure has to be based on the most unfavourable load combination. This can become a tremendous work, if a probabilistic concept with partial safety and various load combination factors is being used like in Eurocode. DIN 1045/78 requires a constant safety factor only.

$$S_d \leq R_d \quad (S_d = \text{design value of internal force or moment, } R_d = \text{design resistance})$$

$$\text{ACI:} \quad S_d [\gamma_G \cdot G_k + \gamma_Q \cdot \sum Q_{k,i} + \gamma_P \cdot P_k] \leq R_d (f_{ck}, f_{yk}, f_{pk}) / \phi \quad \text{with } \gamma_G = 1.4; \gamma_Q = 1.7$$

$$\text{DIN 1045/78:} \quad S_d [\gamma \cdot (\sum G_k + \sum Q_k) + 1.0 \cdot P] \leq R_d (f_{cd}, f_{yd}, f_{pd}) \quad \text{with } \gamma = 1.75 \div 2.1$$

$$\text{EC2:} \quad S_d [\gamma_G \cdot G_k + \gamma_{Q,1} \cdot \sum Q_{k,1} + \sum \gamma_Q \cdot \psi_{0,i} \cdot Q_{k,i} + \gamma_P \cdot P_k] \leq R_d \left(\frac{f_{ck}}{\gamma_c}, \frac{f_{yk}}{\gamma_s}, \frac{f_{pk}}{\gamma_p} \right)$$

with: $\gamma_G; \gamma_Q; \gamma_c; \gamma_s; \gamma_p$ = partial safety factors
 $\psi_{0,i}$ = load combination factor

G = permanent actions ; Q = variable actions ; P = prestressing

In theory the characteristic loads, the partial safety factors and the load combination factors are obtained from existing statistical data. In practice however this is rarely the case. The amount of required load combinations is highly increased, if the load combination factors are not constant. According to EC1-1, Tab. 9.3 they vary with the type of building, type and frequency of loading.

The following example, a continuous beam, should illustrate the problem. The structure is subjected to dead load G_k and imposed loads ($Q_{k1} - Q_{k6}$), whereby the variable actions are treated as independent from each other. The critical load combinations for the ultimate limit state design of the bending moment M_1 are shown in the table. Due to the various load combination factors, the amount of required calculations is highly increased.

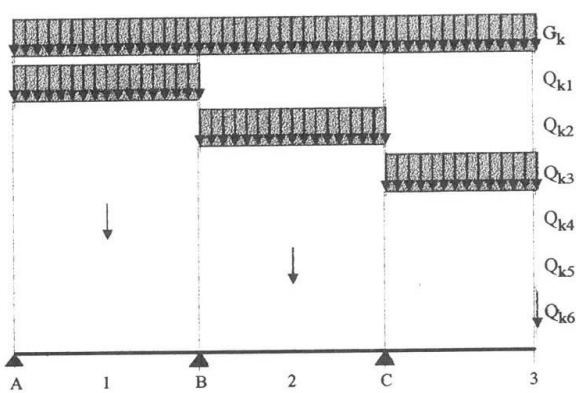

Figure 3 Structure and actions

M1 and support force A	EC2			D I N 1045/88 ULS $\gamma=1.75$ $\psi=1.0$
	ULS		SLS $\gamma=1.0$	
Loadcase	γ	ψ_0	ψ_2	γ
1 : G	1.35	-	1.0	1.75
2 : Q_{k1}	1.50	0.7/1.0	0.3 / 1.0	1.75
3 : Q_{k2}	0.00	-	0.0	0.0
4 : Q_{k3}	1.50	0.7	0.3	1.75
5 : Q_{k4}	1.50	0.7/1.0	0.3 / 1.0	1.75
6 : Q_{k5}	0.00	-	-	0.0
7 : Q_{k6}	1.50	0.7	0.3	1.75

Table 1 Load combination

As can be seen by this example, a „consistent“ safety concept can hardly be used in practice even with a computer. This safety format results in a lack of clearness which can become rather dangerous. It is unquestionable that the probabilistic safety concept with partial safety coefficients is more consistent than design with a constant safety factor. Nevertheless simplifications are required.

5. Analysis

For the calculation of forces and moment the engineer has to make a simplified model of the real structure. This includes simplification of the material and the structural behaviour.

The structural analysis can be based on the following idealisations (see e. g. EC2, cl. 2.5.1.1.).

- elastic analysis with or without redistribution
- plastic analysis including strut and tie models
- non-linear analysis

Most analysis is based on a linear behaviour of the structure because all forces and moments can easily be calculated and the superposition of different load cases is possible. Strut and tie models are mostly used for the design of concrete members with non-linear strain distribution like shear walls or regions with concentrated loads. Non-linear analysis is seldom used in practical design e. g. for slender columns and to estimate the deformation of cracked concrete member. It requires the computer and the prior knowledge of all reinforcement. The material parameters which should



be used -either mean values or unfavourable values- are still under debate as well as the permissible tensile stresses in unreinforced concrete sections. Non-linear analysis of slabs and shell structures as well as shear should be used for research mainly. Due to their complexity such calculations should be carried out by engineers who have sufficient experience in this field.

6. Design of Sections

The design for ultimate limit state of sections subjected to pure flexure based on the various stress strain curves of concrete is generally accepted. Differences between various Codes still exist in the design for shear and/or torsion.

The design for serviceability limit state includes the computation of stresses and deflections under service load condition and the crack control. Durability and in particular corrosion protection of the reinforcement has become one of the major items in the design. The amount of minimum reinforcement, the concrete cover and the required reinforcement to limit the width of cracks has constantly been increased. The crack width may be obtained from the following relation (EC2, equation 4.80, 4.81 and 4.82):

$$w_k = \beta \cdot s_{rm} \cdot \varepsilon_{sm} = \left\{ \frac{1.3}{1.7} \right\} \cdot (50 + 0.25 \cdot k_1 \cdot k_2 \cdot \phi / \rho_r) \cdot \frac{\sigma_s}{E_s} \cdot \left(1 - \beta_1 \cdot \beta_2 \cdot \left[\frac{\sigma_{sr}}{\sigma_s} \right]^2 \right)$$

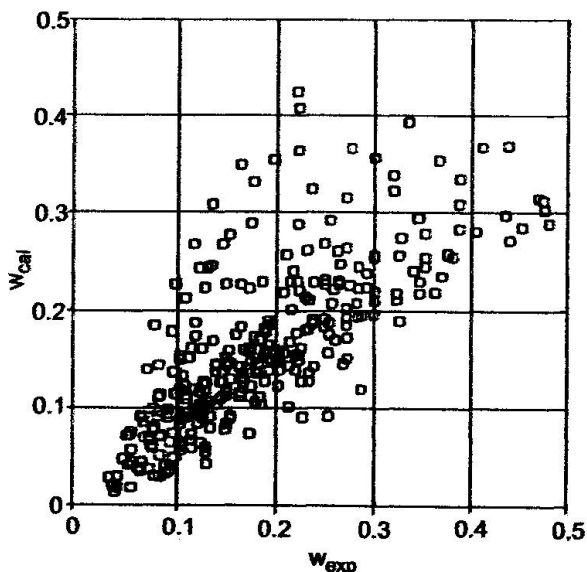

Figure 4 Crack width - calculated versus measured values [5]

Despite the complexity of the equations, the crack width can only be calculated with a rather limited accuracy as shown in figure 4. The designer should be aware of the various reasons for cracking. Good workmanship and detailing is required for crack control rather than sophisticated design models.

7. Example

The limited knowledge in concrete design is demonstrated on a rather simple type of structure, a silo bin. Extensively research had been carried out to estimate the loads due to bulk material. However, there still are a great discrepancies between the different Codes as can be seen from figure 5, where the horizontal wall pressure during discharge for a 27m high silo bin is plotted. A comparative study which was carried out by a FIP Working Group [6] has shown the same results. In addition the study showed that the amount of mild reinforcement differs significantly, more than 100 % in the upper part of the bin, where the minimum reinforcement is the decisive factor.

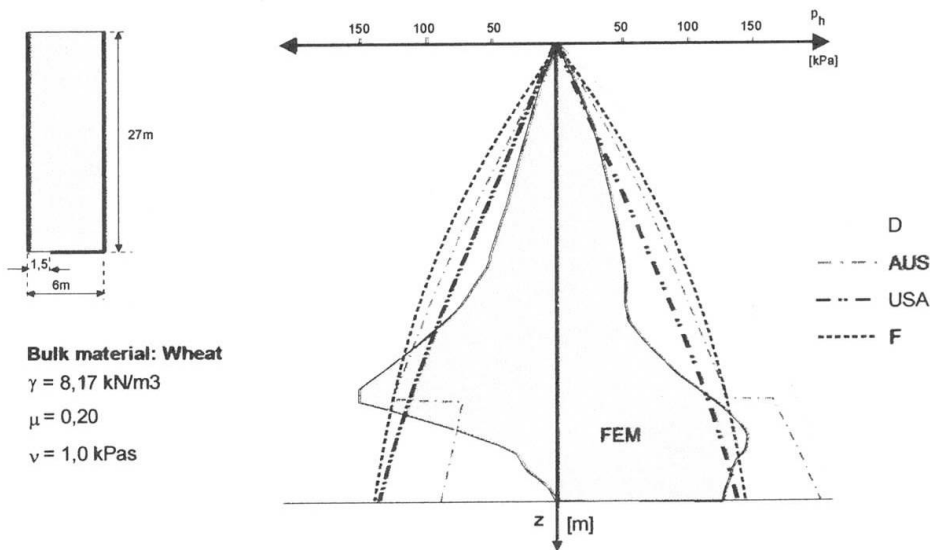

Figure 5 Horizontal wall pressure

After some heavy failures it was recognised that dust explosion may occur in most silos. Taking this accidental action into account loads due to bulk material can be neglected in many cases.

8. Conclusion

In this paper various aspects of concrete design are discussed. It is general accepted that the design of concrete structures can only be of limited accuracy which in practice can't be changed by complex calculations. The increasing complexity offers the risk, that the designer can only rely on figures from computational calculations and loose his feeling for the overall behaviour of the structure. Furthermore, if the regulations become too detailed it may be an obstacle to technical development. The problem is to find a reasonable compromise between state of the art design models and simplified rules. It should be kept in mind that Codes must be written for practical use and therefore they have to be as simple as possible and not too sophisticated. The design has to be on the „safe side“ rather than „precise“.

References

- [1] DIN 1045-1: *Tragwerke aus Beton, Stahlbeton und Spannbeton, Teil 1: Bemessung und Konstruktion*; Draft, issue February 1997
- [2] ENV 1992-1-1 (Eurocode 2 Part 1): *Design of Concrete Structures: General Rules and Rules for Buildings*
- [3] DIN 1045: *Beton und Stahlbeton, Bemessung und Ausführung*; issue: July 1988
- [4] Eurocode 1: *Basis of Design of actions on structures*, 1995
- [5] König G. et al.: *Nachweis der Rißbreite für Konstruktionsbeton* ; Bautechnik 69 (1992), 563 pp.
- [6] FIP Working Group „Silo Design“: *Comparative Silo Design*; Report, Karlsruhe, March 1987



Design Process of Concrete Structures by Performance Based Design

Kyuichi MARUYAMA
Prof. of Nagaoka University of Technology
Dept. of Civil & Environmental Engineering
Nagaoka, Niigata, Japan

Keiichi AOKI
Design Engineer at Japan Highway
Public Corporation
Tokyo, Japan

Tsutomu SATO
Senior Engineer at Railway Technical
Research Institute
Tokyo, Japan

Naoki MASUI
Deputy General Manager at Civil Engg.
Division, Obayashi Corporation
Tokyo, Japan

Hiroshi YOKOTA
Chief Engineer at Port and Harbor Research
Institute, Ministry of Transportation
Yokosuka, Japan

Summary

This paper deals with what the design process should be in the performance based design, and what we have to do near future to make the performance based design effective. At first the historical background of design method for concrete structures in Japan was briefly reviewed. Then, the current situation was discussed on the target of the working group which authors are involved in three aspects, (1) to make a comprehensive chart of design process, (2) to survey current technical means applicable to design and (3) to develop a rational evaluation method for the life cycle cost.

1. Introduction

The Concrete Committee of the Japan Society of Civil Engineers has established nine working commissions for making preparations for a coming new design code based on the performance criteria. The working commission of planning and design, one of the nine WCs, has three tasks. The first one is to make a comprehensive chart of design process of concrete structures under a performance based design code. The second is to survey current technical means applicable to design. In other words, the task is to survey what kinds of software can be commercially provided for the numerical solutions of specific design problems. The third is to develop a rational evaluation method of the life cycle cost of concrete structures.

Throughout the first year activity, the overall design charts were drawn for several concrete structures, such as highway bridge piers, railway bridge piers, box culverts and off-shore structures. The design charts involve the decision making part of planning, the verification process of structural performance and the inspection for maintenance. The demolition and recycle use of materials could be considered taking account of environmental effects. The design service life of structures must be the most important item of requirements. The quality of materials, the way of construction and the necessity of maintenance should be examined to

assure the design service life. The design chart may reveal what should be studied more both in material properties and in structural behaviors.

The survey of numerical techniques shows that reliable softwares are limited to the static elasto-plastic behaviors of concrete structures. There are some programs which can treat the dynamic behavior of concrete structures including the elasto-plastic range. The reliability and the applicability, however, are still in progress. Much more efforts are expected to develop the analytical approaches of the deterioration process of concrete structures.

2. Background of Design Code in Japan

The standard specifications for concrete structures in Japan was firstly established in 1931 by the Japan Society of Civil Engineers (JSCE). At that time the elastic analysis was widely taken into account and the allowable stress design method was adopted in the standard. Since such a design code was very simple and not so many words were necessary in the standard, then, much attention was paid to construction practice. Although the standard specification has been reviewed and revised every five years since then, the allowable stress design method was kept effective as the basis of design for fifty-five years until 1986. During the period lots of technical innovation were made in many aspect, but major revision was mainly done in the part of construction practice in the standard. The revision in the design part was minor within the frame work of the allowable stress design method.

The research and discussion on the mechanical behavior of concrete structures have certainly been continued in the JSCE code committee. In particular, the survey and discussion on the ultimate strength design method started in 1969, and in 1975 the activity was extent to the limit states design method. After a long preparation for revision of the design standard, the limit states design method was newly adopted in the JSCE Standard Specifications for Concrete Structures - Design Part - in 1986. The new standard has been reviewed and revised every five years. After the Great Hanshin Earthquake in 1995, a lot of effort were concentrated on examination of the mechanical behaviors of reinforced concrete structures under severe earthquakes. At the same time the discussion on the revision of seismic design code was actively conducted. The results were summarized in the new design code, the JSCE Standard Specifications for Concrete Structures - Seismic Design Part - in 1996.

The seismic design part, which is apart from the design part, is formulated by the new concept based on the performance criteria. The computer aided verification techniques, such as non-linear finite element analyses, should be fully utilized. This code is a forerunner of the performance based design code. Through the experience of making the seismic design part of the JSCE standard specifications, the JSCE concrete committee has decided to revise the whole part of the standard as the performance based design by 2006.

3. Flow Chart of Design Process

For proceeding the enormous works nine working groups were firstly set up in 1997, such as WGs on (1) Safety, (2) Serviceability, (3) Materials, (4) Construction practice, (5) Initial quality, (6) Durability, (7) Design process, (8) Quality assurance, (9) Maintenance and repair. Table 1 shows the list of working groups.



Table 1 Working groups

WG	Object	Content
WG 1	Safety	Ultimate capacity and seismic resistance
WG 2	Serviceability	Cracking, deformation, vibration etc
WG 3	Materials	Concrete, steel etc
WG 4	Construction	Construction practice
WG 5	Initial quality	Evaluation of initial quality of concrete
WG 6	Durability	Time-depending properties
WG 7	Design process	Flow chart of design process
WG 8	Quality Assurance	Materials and construction practice
WG 9	Maintenance	Maintenance and repair

The authors are involved in the WG7, and this report introduces the outline of the current activity of WG7. The mission of WG7 is to look over the whole design process and to harmonize the activity of each WG in the design process. To make the mission clear, it is requested for WG7 to draw the flow chart of design process taking some structures as examples. Each member in WG7 has been working to make examples of design process with different structures, such as highway bridge structures, railway viaduct structures, underground structures and marine structures. As an example the design process of highway bridge structure is shown below.

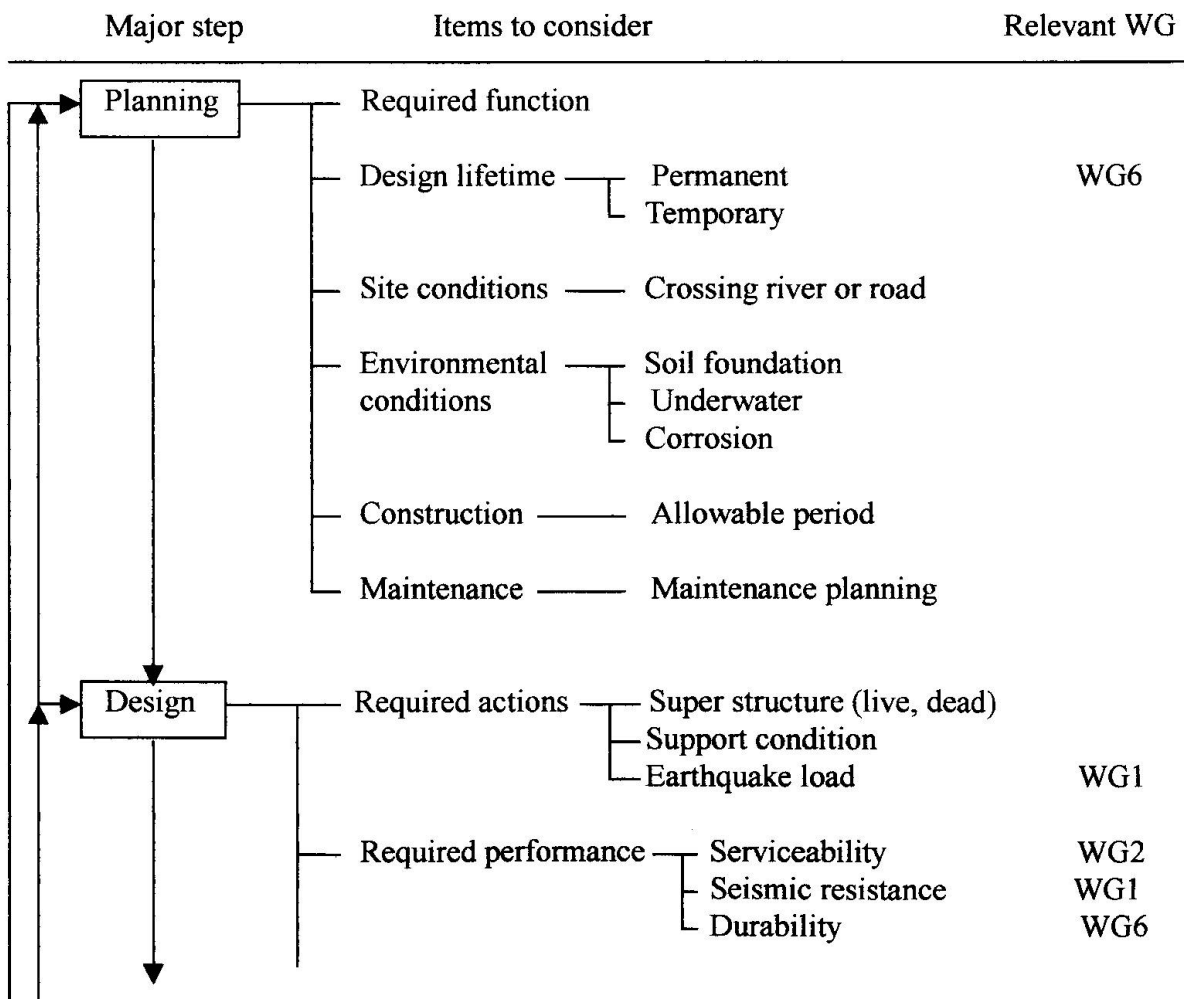

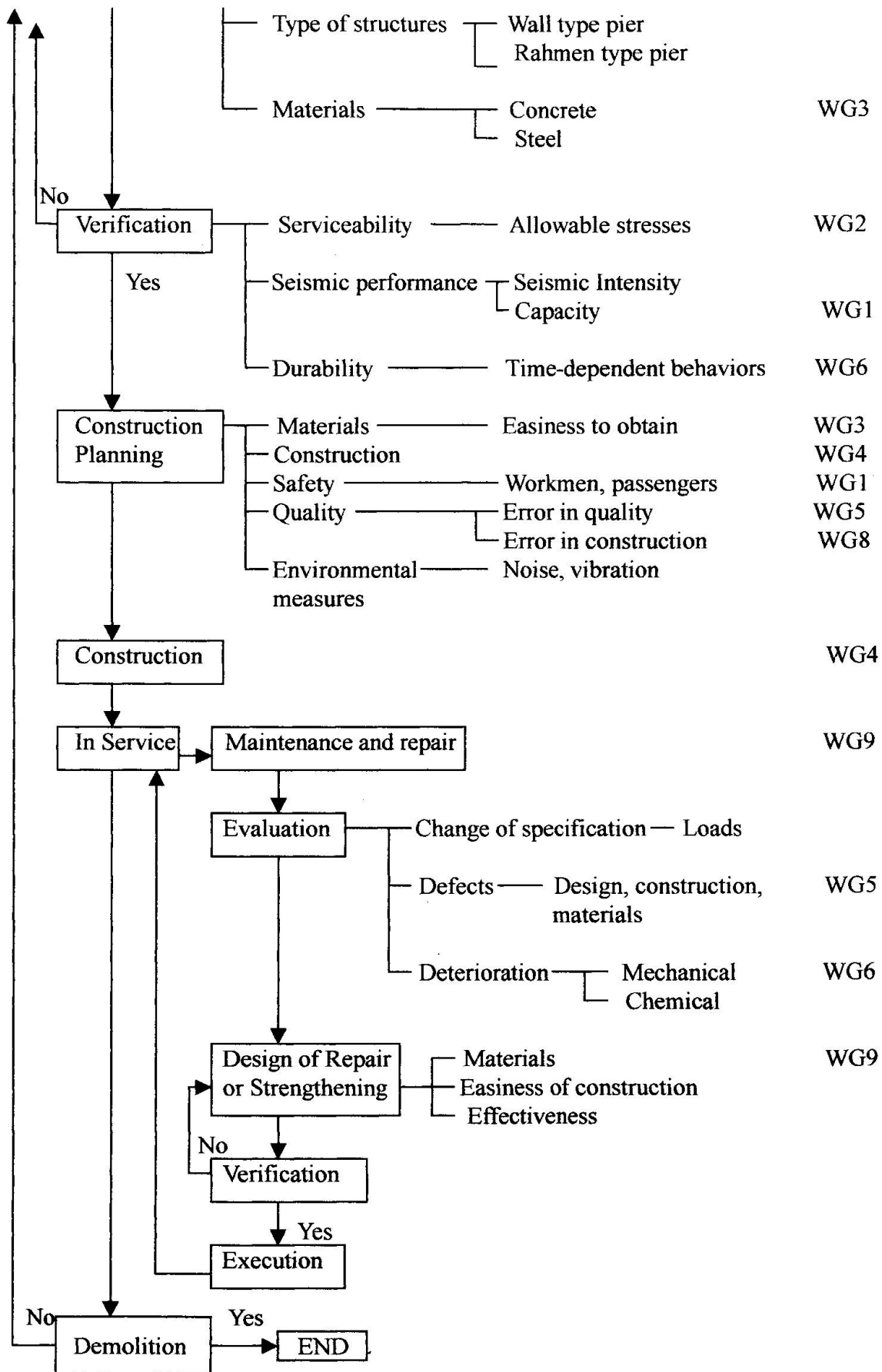

Fig.1 Flow chart of design process of bridge structure



4. Design Aids; available and required

Since the process of planning and design of structures requires a lot of works to do, many engineers must be involved in this process. The process should be divided into several units for effective execution, and the work of each unit may be done by an individual group. The group would be expected to be a specialist for a given work. In addition, so many empirical solutions have been adopted in different aspects of design. Then, what design engineers have to do first is to get used to how to use such solutions, and secondly to conduct many calculations. This situation of design process makes it quite difficult for design engineers to understand how their works influence the overall design.

In order to mitigate this situation, it is necessary to introduce new technology for reducing time consuming calculation works, and to indicate the design process clearly. The time consuming works always come from the verification process requiring so much calculations. Fortunately, recent innovation in computer engineering and the development of numerical technique make it possible to conduct enormous calculations in the verification process by computers. Table 2 shows some examples of what can be done by computer programs in Japan.

Table 2 Computer programs (examples)

Items	Programs
Planning	Determination of bridge span length Perspective simulation of road route Tracing of car movement in railway Determination to traffic lanes Etc.
Design	Overall design system for composite girders Overall design system for railway PC girders RC box girder bridges RC slabs PC rahmen type bridges Etc.
Structural behavior	Stability of slope, break water, etc Frame analyses – 2D, 3D Many types of FEM for various structures – 2D, 3D – linear, non-linear, – elastic, plastic Influence line for girders Sectional capacity Etc.
Seismic analysis	Dynamic response analysis – FEM – 2D, 3D – linear, non-linear, – elastic, plastic – combined of soil movement with underground structures FEM for soil foundation Calculation of natural period of structures Seismic design of RC piers Verification of capacity of RC piers Etc

Table 2 represents only some examples for bridge structures. There are many other computer programs utilized for design. The thermal stress analysis for massive concrete structures is one of the most extensively developed technology in Japan. These programs, however, need more refinement to get higher reliability. In particular, three dimensional analysis should be developed further more in any cases. Not only the analytical study but also the study of micro chemical and mechanical behavior of concrete should be proceeded to take account of the initial properties of concrete as well as the long term deterioration of concrete in design.

5. Necessity of Life Cycle Consideration for Structures

The key point of the performance based design lies in the performance of concrete structures in the life cycle. This gives benefits to both owners and designers of structures. Taking economical conditions into account, the owners can select the suitable condition of structure in the life time from several design alternatives. For example, one choice is to pay much money for obtaining the high quality at the initial stage, and no maintenance cost for the rest of life. The other choice is to pay less at the initial, and to consider maintenance cost later.

The benefit for designers or engineers is to enlarge the acceptance of new technology. The performance based design can reflect new technology quite easily and accept it in design without major changes of design rule. In addition, the consideration for the life cycle behavior of structure is indispensable to make a proper evaluation on the superiority of the initial high quality of structures even if it is expensive.

The members of WG 7 have just started to study how to develop an evaluation model of the life cycle cost of given structures.

6. Concluding Remarks

The most essential point of the performance based design lied in the verification technology. When we have a highly reliable and widely applicable analysis for a required performance, for example, a FEM for the flexural capacity of structural members, we can command the structural design at will. After constructing the frame work of design process, the WG 7 is now making some design examples by the new method with examining how effective the current verification techniques are.

References

- 1) JSCE: Standard Specifications for Concrete Structures – Design Part–, 1996 (in Japanese)
- 2) JSCE: Standard Specifications for Concrete Structures – Seismic Design Part –, 1996 (in Japanese)
- 3) JSCE: Concrete Library 87 – Commentary on the JSCE Standard Specifications for Concrete Structures – Seismic Design Part –, 1996 (in Japanese)
- 4) Maekawa, K. and Miyamoto, K.: Direction of Performance Based Design in Civil Engineering, JCI journal of Concrete Engineering, No.11, pp.14-18, 1997 (in Japanese)



Recommendation for Design and Construction of Concrete Structures Using Continuous Fiber Reinforcing Material

Atsuhiko Machida
Professor
Saitama University
Urawa, Japan



Taketo Uomoto
Professor
University of Tokyo
Tokyo, Japan



Machida Atsuhiko, born 1940, received his Doctor of Engineering Degree from University of Tokyo in 1973. He was the chairman of Committee on CFRM in JSCE.

Taketo Uomoto, born 1947, received his Doctor of Engineering Degree from University of Tokyo in 1981. His major research field is construction materials, including FRP, durability of concrete, non-destructive test and shotcrete.

Summary

This paper describes the outline of Recommendation for Design and Construction of Concrete Structures Using Continuous Fiber Reinforcing Material (CFRM), which was prescribed by the Japan Society of Civil Engineers (JSCE) in 1996. In order to design and construct concrete structures reinforced or prestressed with CFRM properly, a standard has to be provided, because the properties of CFRM differ greatly from those of conventional steel reinforcements or prestressing tendons. The purpose of Recommendation by JSCE is to fulfill such requirements and to focus on the precautions originated from the properties of CFRM in various aspects. It also includes Proposed Quality Standards for CFRM and Proposed Test Methods for CFRM. The former specifies the necessary items to classify currently available CFRM, and the latter specifies ten test methods to evaluate the necessary properties of CFRM.

1. Introduction

Continuous Fiber Reinforcing Materials (hereafter, CFRM) for concrete structures have been attracting a wide attention because of its several advantages such as high tensile strength, high corrosion resistance, etc. The term "continuous reinforcing materials" is Japanese terminology for FRP reinforcements or prestressing tendons used elsewhere. However, some special precautions are needed for the use of CFRM in structures properly, because the properties of CFRM differ greatly from those of conventional steel. In order to provide a standard for the use of CFRM and widen its application, Japan Society of Civil Engineers (hereafter, JSCE) carried out intensive research works under the guidance of the authors during the past 5 years, and published "Recommendation for Design and Construction of Concrete Structures Using Continuous Fiber Reinforcing Materials" [1] in 1996. The Recommendation consists of Recommendation for Design, Recommendation for Construction, Proposed Quality Standards for CFRM and Proposed Test Methods for CFRM. The Recommendation for Design and Recommendation for Construction require that only the CFRM that meet Quality Standards are to be used. Whether a CFRM meets the Quality Standards or not is determined based on the results of the tests which are conducted following the Standard Test Methods.

2. Recommendation for Design

The Recommendation for Design is based on “Standard Specification for Design and Construction of Concrete Structures – Design Part” [2], which is prescribed for concrete structures in general by JSCE, and adopts the limit states design method. The concept of the limit states design method is similar to that of the model code by the European Concrete Committee. The main contents of the Recommendation for Design are design values for materials, design for ultimate limit states, design for serviceability limit states and design of prestressed concrete members.

2.1 Design Values of Materials

In this chapter, it is specified that the tensile strength of CFRM shall be determined following the equation 1.

$$f_{fd} = (m - 3 \cdot \sigma) / \gamma_{mf} \quad (1)$$

where f_{fd} is design tensile strength of CFRM, m is mean value, σ is standard deviation, γ_{mf} is material factor for CFRM and is taken as 1.15 – 1.30. The probability of breakage of CFRM is kept less than 10^{-6} by following this equation. Besides the tensile strength, strengths of curved tendons and bent portions are also specified in this chapter. These strengths have to be specified because CFRM has little plastic behavior.

2.2 Design for Ultimate Limit States

Test methods for member resistance for axial load, bending moment and shear force are specified in this chapter. As far as flexural capacity is concerned, the provisions are such that the assumptions for usual reinforced concrete shall be adopted but ultimate strain of CFRM must be used instead of the tensile strength to define the ultimate state. This is because the flexural capacity is governed by the breakage of CFRM, and strain attains the maximum value when flexural failure due to fiber rupture takes place. For shear capacity, the following equations are specified to examine the capacity. These equations are the modified ones based on traditional equations for conventional steel reinforced concrete structures, taking into account the characteristics of CFRM.

$$V_{ud} = V_{cd} + V_{sd} \quad (2)$$

where V_{ud} is ultimate shear capacity, V_{cd} is the contribution of concrete section, and V_{sd} is the contribution of shear reinforcement. V_{cd} is expressed as

$$V_{cd} = \beta_d \beta_p \beta_n f_{ct} \cdot b d / \gamma_b \quad (3)$$

$$\beta_p = \sqrt{100 p_w E_f / E_s} \quad (4)$$

where the notations of equation (3) are given in the reference [2], β_p is the term to express the effect of main reinforcement ratio $p_w = A_f / b_w d$, which is reduced by the ratio of modulus of elasticity of CFRM E_f to that of steel E_s . This is to take into account the fact that the shear



capacity is lowered due to its low modulus of elasticity in comparison to that of steel. The equation to express the contribution of shear reinforcement is

$$V_{sd} = [A_w E_w \varepsilon_{fud} (\sin \alpha_s + \cos \alpha_s) / s_s] z / \gamma_b \quad (5)$$

$$\varepsilon_{fud} = \sqrt{f'_{mcd} \frac{p_w E_f}{p_{web} E_w} \left[1 + 2 \left(\frac{\sigma'_N}{f'_{mcd}} \right) \right]} \quad (6)$$

The equation (5) is based on the conventional truss analogy, and the yield strength of shear reinforcement is replaced by $E_w \varepsilon_{fud}$, where ε_{fud} is calculated by equation (6), f'_{mcd} is design compressive strength of concrete allowing size effect, and σ'_N is average axial compressive stress. When the failure mode of members with CFRM is shear compression type, strain of shear reinforcement made of CFRM does not necessarily reach the ultimate one, and equation (6) is able to take into account this fact. It was shown that the above equations give lower bound values, as compared with the experimental results.

2.3 Design of Serviceability Limit States

In this chapter, methods for the examination of deflection, crack width, and so on are specified. Because CFRM is usually less corrosive, it is very difficult to specify the allowable crack width. The provisions for the allowable crack width are: allowable flexural crack width shall generally be determined based on the intended purpose of the structure, environmental conditions and member conditions; allowable crack width for aesthetic considerations may generally set to be not more than 0.5 mm, depending on the ambient environment of the structure; crack limitations and allowable crack widths for considerations of water-tightness shall be based on the Standard Specification [2]. To calculate flexural crack width, the equation specified for conventional steel reinforced concrete in the Standard Specification [2] can also be applied to the case of members reinforced with CFRM only if bond characteristics and multiple placement of CFRM are properly evaluated.

In the case of deflection, the equation for ordinary steel reinforced concrete members can also be applied to the members with CFRM. Deflections in some cases may be larger due to low modulus of elasticity and low reinforcement ratio, and in such cases the increased deflection makes shear cracking more likely. This, in turn, is considered to have some effects on deflection or displacement of the structure. The precautions in this regard are also specified.

3. Recommendation for Construction

The Recommendation for Construction is also based on the "Standard Specification for Design and Construction of Concrete Structures - Construction Part" [2] by JSCE, and consists of the chapters comprising general, materials, construction and quality control and inspection. Among them, only the contents of the first three chapters will be explained because the last chapter is not so greatly different from the case of ordinary reinforced or prestressed concrete structures.

3.1 Materials



In this chapter, qualities of the materials such as concrete, CFRM, steel reinforcement, etc. are specified. Among the provisions, less stringent provisions are specified for chloride content in concrete, because CFRM is less corrosive. However, the precautions to avoid the use of reactive aggregates are added because the alkali aggregate reaction will be exacerbated, if an excess of alkali ions co-exists with chloride ions. It is also specified that the epoxy-coated re-bar shall be a standard re-bar when steel reinforcement has to be used in conjunction with CFRM. At the same time, some provisions or recommendations are given for the use of new materials such as corrosion-proof prestressing tendons, plastic sheaths, coating materials to prevent bonding between CFRM and concrete, protection materials to protect CFRM from external or chemical damage and high-quality grout with super plasticizers.

3.2 Construction

This chapter treats handling and storage of the materials, fabrication, placement and installation, concrete works, prestressing and grouting, etc. For handling and storage of CFRM, the most important point is to avoid the deterioration of CFRM, hence the provisions for this point are specified. The situation is just same in fabrication, placement and installation, and in particular, necessary precautions to be taken are specified for curved arrangement of CFRM and bending of CFRM to make stirrups or spiral hoops, because strength of CFRM is reduced due to these treatments. As for concrete works, it is also specified that, proper care should be taken not to damage CFRM. In particular, as CFRM may be damaged by direct contact with an internal vibrator, it is recommended that an internal vibrator should be protected with a urethane covering.

3.3 Prestressing and Grouting

Taking into account the fact that CFRM exhibits greater elongation under the same prestressing force than the conventional prestressing steel, provisions are provided for the use of a jack with long stroke, or repositioning of the jack during prestressing works. At the same time, it is commented that the pull-in when anchoring CFRM may in some cases be greater than the case of prestressing steel, but the tension loss in CFRM due to set in the anchorage is less than that of prestressing steel.

4. Proposed Quality Standards for CFRM

The Quality Standards consist of the following chapters: Scope; Representation; Categories, Identification, Designations; Fiber and Fiber Bond Quality; Mechanical Properties; Nominal Diameter and Maximum Dimension; Testing; Calculation and Inspection. The specified mechanical properties of CFRM are as shown in Table 1. The first column of the table shows fiber categories, CFRM configurations and the rounded ratio by volume of axial fibers. The first symbols C, A, G and V denote carbon fiber, aramid fiber, glass fiber and vinylon fiber respectively, and the second symbols R, D, S, B, L and P denote round rod, deformed rod, strand, braid, lattice and plate respectively. The listed values of mechanical properties are the ones obtained based on the Standard Test Methods for CFRM. The primary targets of the Quality Standards are to clear what are the required properties for CFRM, what the current situation is and to suggest what type of CFRM should be developed in future, by identifying respective CFRM.



Table 1. Mechanical Properties of CFRM

Designation ¹⁾	Ratio by Volume of Axial Fibers (%)	Guaranteed Strength ^{2),3)} (N/mm ²)	Modulus of Elasticity (kN/mm ²)	Elongation (%)	Creep Failure Strength ²⁾ (N/mm ²)	Relaxation Rate ³⁾ (%)	Durability
CR65, CD65	63-65	1240	99-170	1.0-1.5		2-3	
CR50A, CD50A	49	960*	200	0.5			
CR50B, CD50B	49-52	780	190	0.4-0.5			
CS65A	64-66	980	73-210	0.5-1.5		1.04-1.06	
CS65B	64-66	790	84-170	0.5-1.4			
CL40	43	1200*	100	1.2			
C3D	60	1490*	130	1.1			
AR65, AD65	65	1720	59-60	2.9-3.1		7-14	
AS65A	60-69	1710	42-47	3.5		8.0-8.6	
AS65B	60-69	1830*	44-45	3.5			
AB65	66	1400	63-78	2.0		10	
AP65	49	1330	62	2.15		11	
AL40	43	1300*	57	2.2			
GR65, GD65	65-68	1130	37-49	2.5-2.7		1.82	
GL40	40	590	30	2.0			
GCL40A	40	530	37	1.4			
GCL40B	40	530*	37	1.4			

1) A:D<20mm, B:D≥20mm

2) Guaranteed strength and creep failure strength are guaranteed capacity and creep capacity divided by nominal area, respectively.

3) Tentative values obtained by different test methods.

4) * denotes values for only one product.

5) Blanks are due to insufficient data at this moment.

5. Proposed Test Methods for CFRM

Proposed test methods are for tensile properties, flexural tensile properties, creep failure, long-term relaxation, tensile fatigue, coefficient of thermal expansion, performance of anchorages and couplers, alkali resistance, bond strength and shear properties. Among them, the test method for tensile properties is the most fundamental one, and it specifies the methods for determination of load-displacement curve, tensile strength, tensile rigidity and Young's modulus and ultimate strain. The points of the provisions are: the length of the test piece shall be the length of the test section added to the length of the anchoring section; the length of the section shall be not less than 100 mm and not less than 40 times the nominal diameter of the CFRM; for CFRM in strand form, the length shall be more than 2 times the strand pitch as an additional condition; the number of test pieces shall not be less than five; the test temperature shall generally be within the range 5-35 degrees Celsius; the material properties of CFRM shall be assessed on the basis only of test pieces undergoing failure in the test section. The provisions for test pieces are also applied to the test methods for creep failure, long-term relaxation, tensile fatigue and alkali resistance. As for creep failure capacity, the ratio of creep failure capacity to tensile capacity at 1 million hours is determined based on the result of 1000 hours, assuming linear relationship between the load ratio and logarithm of time. The same principle is applied for the determination of long-term relaxation. In the test method for alkali resistance, it is specified

that the test pieces are immersed in alkaline solution with temperature of 60 degrees Celsius and with the composition same as the pore solution found in the concrete, and the reduction in strength and change in mass after one month of immersion are determined

6. Concluding Remarks

The outline of "Recommendation for Design and Construction of Concrete Structures Using CFRM" by JSCE is introduced. Although, CFRM is not necessarily the material fully replacing the steel reinforcements or prestressing tendons, it is a very useful material for making structures highly durable against chloride attack or constructing non-magnetic structures, because of its less corrosive and magnetic properties. In particular, applications in seismic retrofitting and earth anchors are remarkably increasing in Japan. Considering these facts, it can be said that the demand for CFRM will gradually increase in the days to come. In order to design and construct structures reinforced or prestressed with CFRM properly, however, some precautions that are not necessary for ordinary reinforced concrete structures are needed, mainly because of its brittle nature and low modulus of elasticity. The Recommendation outlined in this paper throws lights to those points. In conclusion, the authors sincerely wish further development of CFRM and its widespread applications.

Acknowledgment

The research committee on CFRM was entrusted by the "Association of Composite Materials Using Continuous Fibers for Concrete Reinforcement" and "Composite Cable Club". The "Recommendation for Design and Construction of Concrete Structures Using CFRM" was completed with the efforts of all the committee members. The authors would like to express their sincere gratitude to the two organizations and all the committee members.

References

- [1] Research Committee on Continuous Fiber Reinforcing Materials (edited by Atsuhiko Machida), Recommendation for Design and Construction of Concrete Structures Using Continuous Fiber Reinforcing Materials, Concrete Engineering Series 23, Japan Society of Civil Engineers, 1997
- [2] Concrete Committee, Standard Specification for Design and Construction of Concrete Structures, Part 1 (design) and Part 2 (construction), Japan Society of Civil Engineers, 1997 (in Japanese)



Design Strategies for Concrete Structures

Koji SAKAI
Kagawa University
Takamatsu, Japan



Koji Sakai is Head of Department of Safety Systems Construction Engineering, Kagawa University.

Summary

It is presumed that the next century will be the century of the environment. Concrete technology will not be an exception in this regard. Recently, there were two important meetings in which author was involved. One is International Workshop on Concrete Technology for a Sustainable Development in the 21st Century, which was held in Norway in June 1998. The other is JCI TC 961 (Technical Committee on Interface Problem between Structural and Durability Design of Concrete Structures) Symposium, which was held in Japan in July 1998. In the meetings, the new target which we should direct was definitely established. In this paper, the essences from the events are described.

1. Introduction

A workshop on “Concrete Technology for a Sustainable Development in the 21st Century” was held at Lofoten Islands, Norway, during 24 - 27 June 1998. This Lofoten workshop is on the extension of the workshop on “Rational Design of Concrete Structures” at Hakodate, Japan, in 1995 in which it was emphasized that next century will be the century of the environment. There were two significant points in the Hakodate Workshop (1). One was integration of structural design and durability design as a rational method of design. The other was concrete technologies in relation to global environmental issues. Based on the discussions in the workshop, the following “Hakodate Declaration” was adopted:

1. We, concrete experts, shall place environmental consciousness at the center of concrete technology towards the 21st century.
2. We, concrete experts, shall change the framework of concrete technology by integrating structural design and durability design and by considering planned maintenance.

It can be said that the Hakodate Workshop showed the direction of concrete technology in the century of the environment. However, it was just a beginning of introducing a new concept into the field of concrete technology.

Twenty nine papers were presented in the Lofoten Workshop (2), which led to fruitful discussions. Based on the discussion, the following “Lofoten Declaration” was adopted:

We concrete experts shall direct concrete technology towards a more sustainable development in the 21st century by developing and introducing into practice:

1. Integrated performance-oriented life cycle design
2. More environmental-friendly concrete construction
3. Systems for maintenance, repair and reuse of concrete

structures

In addition, we will share information on all these issues with technical groups and the general public.

On the other hand, in the JCI TC 961 Symposium, the committee Report of JCI TC 961 and three papers by Dr. Corley, Dr. Litzner and Dr. Somerville who have been involved in making major codes were presented.

In this paper, the essences from both meetings are reviewed.

2. Design systems and strategies

There is no doubt that rational design of concrete structures is the key for a sustainable development in the 21st century. Although we have different types of design method, most of them are strength-oriented design. It means that durability or long term performance of concrete has not been incooperated into the codes or specifications in rational shapes.

Sakai et al. (3) proposed an integrated design method which include structural design and durability design and described the direction of technology development in the scope of the integrated design. Fig.1 shows the framework of integrated design. The characteristics of the proposed framework are as follows:

- (1) Basic design concept is "performance-based evaluation."
- (2) Final goal ia to grasp the behavior of structure accurately.
- (3) Technologies developed in the future are easily incorporated into the design, or in other words it enables rational design according to the development level of the technology.
- (4) Safety and durability can be integrated rationally, or in other words it becomes integrated design.

As shown in Fig.1, two extreme cases were considered. One is the method to grasp the behavior of a structure, based on a model in terms of the material properties as a function of time and their relationship with the mechanical properties of a cross section, an element or a structural member and to verify whether they fulfill the required performances (Flow B). This method would be difficult at present and should be established in the future. The other case is to examine mechanical and durability aspects separately, and to fulfill the required performance for each aspect (Flow A2). An intermediate method between the two will be also possible (Flow A1). Although the examination for mechanical behavior is not necessarily at a satisfactory technological level, it can be regarded as usable as a whole, as seen in the limit state design. However, there is no doubt that durability design is at an extremely primitive design level.

In the paper, they concluded as follows: "Technology is the reflection of a social system. That is to say technology develops in the framework of the social system of an era, therefore, the direction of development of technology changes when the value standards of people change along with their social environment. The situation surrounding concrete structures has also changed greatly. First, the myth that concrete is maintenance-free was proven untrue. Second, because of the serious economic situation, a tight control over construction costs and gurantees of longer life have been strongly demanded. This means that a structure must be designed taking cost-performance into consideration. The direction in which we have to proceed is obvious." It is also quite obvious that longer life or cost-performance is a very important aspect in realizing a sustainable development.

The outline of provisions made based on the above framework is as follows (4):

1. General
2. Required performance and load and environmental actions
 - 2.1 General requirements
 - (1) Constructability, serviceability, safety, durability, aesthetics/landscape

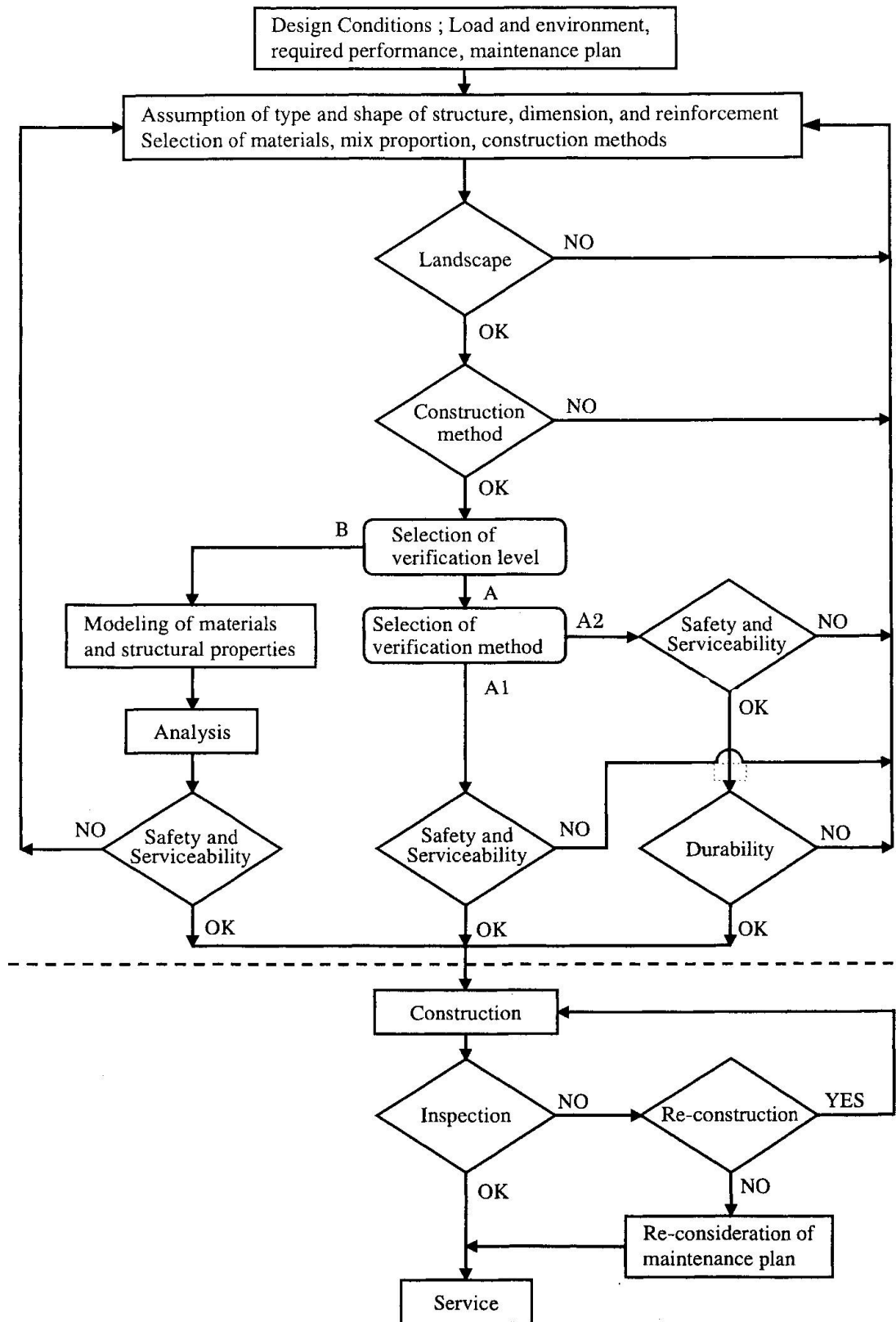

Fig. 1 Framework of integrated design(3)



- (2) Environmental load, effect of society, culture and economy
 - 2.2 Constructability
 - 2.3 Serviceability
 - (1) Performances which satisfy the five senses of the user (comfortable ride, vibration, aesthetics/landscape, uneasiness caused by the view, smell), water-tightness, sound isolation.
 - 2.4 Safety
 - 2.5 Aesthetics/landscape
 - 2.6 Environmental load
 - 2.7 Conditions from the viewpoint of society, culture and economy
3. Performance verification and inspection
 - 3.1 General
 - (1) It is important to quantitatively evaluate the behavior of structure, considering the properties of materials and structure, as well as load and environmental actions, and the required performance shall be verified based on these results.
 - To quantitatively evaluate the behavior of structure, appropriate models, including structural, material models and mass transfer model shall be determined.
 - The following models can be utilized for the penetration of chloride ions, oxygen, water, carbon dioxide into concrete and subsequent chemical reactions.
 - The following models can be utilized for the deterioration of the concrete (crack or disintegration) due to freeze-thaw or chemical actions, and loss of material (scaling or spalling).
 - (2) When required performance can be checked by the appropriate performance test or inspection, they can be converted to verification of the design conditions.
 - (3) When it is difficult to trace time-dependent structural behavior, the limit states can be set properly according to the required performance, and the verification of the performance can be deemed to have been conducted by confirming that the material, member or structure do not reach their respective limit states.
 - (4) Appropriate safety factors shall be included in performance verification process considering the reliability of the verification and inspection.
 - 3.2 Verification of constructability
 - 3.3 Verification of serviceability
 - (1) The verification of serviceability shall be conducted based on quantitative evaluation considering variable load and environmental actions, as well as regular load and environmental actions on the structural system in the life span.
 - (2) When it is difficult to conduct the methods described in (1), some appropriate limit states for materials, member or structure shall be set and the verification of serviceability performance shall be conducted.
 - (3) When the quantitative evaluation of the behavior of the structure due to the environmental action is difficult, durability performance to consider the effect of the environmental action can be set as the required performance and the verification shall be conducted based on this requirement. It is possible to set the durability performance where the structure maintains the situation at the beginning of service life as durability performance 1, and the durability performance where the deterioration is such that no loss of function is allowable and no strengthening work is necessary as durability performance 2. In this case, appropriate safety factors shall be taken into account for the mechanical evaluation of serviceability.
 - (4) In the verification of each durability performance, an appropriate durability index can be set in accordance with the environmental actions to be considered.
 - (5) In calculation of each durability index, effect of mechanical cracks of concrete and combined effect due to different environmental actions shall be appropriately incorporated.
 - (6) The following equations can be used regarding accumulation of chloride ions, progress of carbonation, corrosion of steel, and initiation and progress of cracking in the concrete.
 - (7) Appropriate methods can be used to evaluate the degree of deterioration or damage of concrete due to freeze-thaw or chemical action.



- (8) The amount of permeable water in concrete shall be calculated by using an appropriate permeability model.

3.4 Verification of safety

- (1) The verification of safety shall be conducted with quantitative evaluation considering variable load and environmental actions, as well as regular load and environmental actions on the structural system in the life span.
- (2) When it is difficult to conduct the methods described in (1), some appropriate limit states for materials, members or structures shall be set and the verification of safety performance shall be conducted.
- (3) In the calculation of limit state index of materials, members or structures, the effect of earthquake and environmental actions shall be appropriately incorporated.
- (4) In the verification of safety against earthquakes, it is possible to set the seismic performance where the structure can function properly after the earthquake without any repair work (Seismic performance 1), the structure can recover the function in a short period of time without any strengthening works (Seismic performance 2), and the structure as a whole system does not collapse (Seismic performance 3).
- (5) The verification for each seismic performance shall be conducted using appropriate ground motion.
- (6) When the effect of environmental action cannot be evaluated along with the mechanical behavior in a combined manner, the durability performance can be set as durability performance 3 which implies large scale repair or strengthening work. In this case, appropriate safety factor shall be considered in the evaluation of the safety of mechanical behavior.
- (7) The verification of durability performance 3 shall be achieved by evaluating properly the deterioration due to the environmental action.

The concept in which design of structure is conducted according to the required performance, is not necessarily a new idea, but it should basically be the origin of the design. From the immaturity of technology and the demand of efficiency, the design specification based on prescriptive provisions has gradually increased. This is frequently seen in durability design. Ultimate limit design for structural design implies basically "performance-based design." However, in most codes, the whole framework is not well defined, and the prescriptive provisions are mixed up as typically shown in the structural details. Therefore, it can be said that the ultimate limit state design is not really equal to a unified performance-based design. This kind of design framework has hidden the problematic place and the future direction where we should aim. The framework proposed covers all situations. There is no barrier. Engineers can choose any method depending their technical level and other conditions.

Maekawa et al. (5) showed a challenge to make the above-mentioned Flow B possible. Their fundamental standpoint is that the unified approach of mechanics which governs stress and strain fields and thermo-hygro physics ruling mass and energy transport associated with thermo-dynamic state equilibrium would serve as a technicality of ensuring total performances of concrete structures as well as structural concrete performance over the life span of concrete structures. Their approach covers (a) the hydration of cement in concrete volume, corrosion of steel, moisture migration and associated transport of solved ion ingress and micro-pore structural formation (thermo-hygro physics: DuCOM sub-system) and (b) structural behaviors expressed by displacement, deformation, stresses and macro-defects of materials in view of continuum plasticity, fracturing and cracking (continuum mechanics of materials and structures: COM3 and sub-system of mechanics). For solving two sub-systems as for micro structural by DuCOM and macro structural performances by COM3 with mutual interaction, complete amalgamation of these dual systems in a single processing was considered. An example was shown on the process.

They concluded that if we may simulate cyber materials and structural behaviors in a virtual world under artificial environments and mechanical actions, we could see what happens within shortened period. If this becomes practical in the future, it means that a design for a really sustainable development will be accomplished.

Gjørsv (6) emphasized that appropriate programs for life cycle management should be established because an increasing spending of resources for repairs, rehabilitation and premature demolition

which is based on an uncontrolled service life is poor utilization of natural resources. The current experience on field performance and engineering practice was outlined. In Norwegian coastline bridges, more than 50% of the larger bridges have a varying extent of steel corrosion or has been repaired due to steel corrosion. Most of these bridges have been built during the last 25 years. In Norwegian harbor structures, although, based on improved technology, new harbor structures appear to perform much better, it was found that corrosion problems still occur on several new structures already after a service period of less than 10 years. For most of these structures, current standard requirements to both concrete quality and thickness of concrete cover have been fulfilled. In offshore structures in the North Sea, most of them have been in good condition without any visible sign of deterioration. However, it was demonstrated that the chloride penetrate the high quality concrete only at a slower rate. In the Oseberg A platform, where the concrete cover has partly been less than prescribed, corrosion has already occurred, and cathodic protection is currently being installed. Good performance of concrete platform comes from the increased concrete quality requirements. On the contrary, in the land-based concrete structures, the traditional requirement to compressive strength was almost the only concrete quality requirement until the late 1980's. This descriptive approach has shown to yield insufficient and unsatisfactory results. In addition, he pointed out that although several numerical models for chloride penetration are available, these models do not yet seem to have any satisfactory and practical validation.

Based on this historical background, he suggests that it may be better to have a strategy for a more controlled prevention of chloride penetration based on an appropriate program for life cycle management. As a strategy to obtain a more controlled chloride penetration, protective surface treatments or coating were recommended. It was also emphasized that a regular monitoring of the chloride penetration provide a most reliable basis for the preventive maintenance. It can be said that this is the most practical way until more sophisticated methods are available in the future.

Sarja (7) described that sustainable building is defined as a technology and practice which meet the multiple requirements of the people and society in an optimal way during the life cycle of the build facility, and the most important sustainability factors in performance for structures with long target service life can therefore generally be defined as flexibility towards functional changes of the facility and high durability, while in the case of the structures with moderate or short target service life changeability and recycleability are dominating.

It is valuable to cite his comment that ecology can be interpreted as the economy of the nature. Namely, the application of this aspect to materials and structural engineering can be concretized in the life cycle methodology in design, manufacturing, construction, maintenance and management. It was described that the multiple requirements optimisation is needed using appropriate index. In addition, the following equation to calculate the life cycle cost was shown:

$$E_{\text{tot}}(t_d) = E(0) + \sum [N(t) \cdot E(t)]$$

where E_{tot} is the design life cycle cost, $E(0)$ is construction cost, $N(t)$ is coefficient for calculation of the current value of the cost at the time t after construction, and $E(t)$ is cost to be born at time t after construction.

Somerville (8) presented a holistic approach to structural durability design which comes from an idea that good performance-in-service-with time is a sustainability issue, i.e. a structural design approach to durability is the best means of achieving that. The holistic approach here means a durability design embracing material, design and construction matters, although it seems that this is an origin of concrete technology. The keys he suggested to realize the holistic approach are as follows:

- (1) The establishment of performance requirements, in practical whole life terms, including the future operation of the structure, and its management and maintenance.
- (2) How to deal with relevant environments, in a design context.
- (3) Variations in construction quality, as influenced by design detail, construction method and workmanship.
- (4) The precise make up of the design framework, which simultaneously



embraces all relevant factors and provides the required reliability.

Mehta (9) described that infrastructural needs in our rapidly industrializing world will have to be balanced against another equally important human need, namely the preservation of the life-sustaining environment on the planet earth, which is being threatened by the uncontrolled use of natural resources and increasing amounts of environmental pollution. In addition, it was emphasized that, being an important player in the infrastructural development and a major consumer of natural resources of the earth, the concrete industry needs to be reoriented through the adoption of environment-friendly technologies. Crucial key elements were identified as follows:

- (1) Conservation of concrete-making materials.
- (2) Enhancement of durability of concrete structures.
- (3) A paradigm shift from reductionistic to a holistic approach in concrete technology research and field practice.

It was emphasized that the goal of sustainable development of the cement and concrete industries is the complete utilization of the cementitious and pozzalanic by-products produced by thermal power plants and metallurgical industries. Concerning the enhancement of durability, it was described that the challenge lies in making the ordinary concrete a highly durable, high-performance building material for the future structures. He also commented that the prevailing reductionistic approach is, in fact, responsible for many wasteful practices in concrete technology today because according to this approach all aspects of a complex system can be fully understood and controlled by reducing it to parts and considering only one part at a time, and as a result, test methods for concrete durability, materials specifications, and codes of recommended practice have failed to consider that durability is a holistic (pertaining to the whole structure) performance criterion which must take into consideration many factors including weather conditions, structural design, and concrete processing. It was concluded that as long as the concrete community continues to pursue reductionistic solutions to major technological and societal problems confronting us, it will neither attract highly motivated researchers nor the financial support needed for sustainable development.

Moksnes (10) discussed a sustainable development in concrete from the completely different angle. A number of international associations are active in the field of promoting research and development and in the dissemination of knowledge related to concrete and concrete structures. As the relationship between the individual engineers and scientists, their employers, national associations and the international umbrella associations, Fig. 2 was shown. Loop 1 is the vast majority of engineers. Loop 2 embraces the National Association which companies, institutions and individuals join and support through activities on committees and commissions. Loop 3 brings in the voluntary international association and their interrelations with their Member Groups. Loop 4 is the problem and the main challenge when examining the role of the voluntary international associations, namely the interaction and efficient cooperation between the different associations and the interaction with society (politicians, planners, authorities, customers, media). It was pointed out that when concrete people get together in committees, for meetings or for Congresses and Symposia, they talk to themselves and very seldom are society or people issues addressed. This means that even if we discussed the sustainable development in concrete technology without a strategy to the public, it does not work.

3. Repairs/rehabilitations and retrofitting

From environmental considerations and shrinking public budgets, it will become more significant to prolong the life span of existing structures by repairs or rehabilitations and retrofitting. Horrigmoe (11) emphasized that we should consider the solution to the problems of deteriorating infrastructure as a part of the challenge of creating a sustainable development in the 21st century and there is a need for significant improvements and innovations of existing repair techniques to meet future demands of costs and performance. As a numerical simulation, nonlinear finite element analysis of damaged and repaired concrete beams was shown. It was also described that the use of externally bonded carbon fiber reinforced plastics for strengthening and repair is a promising new technique.

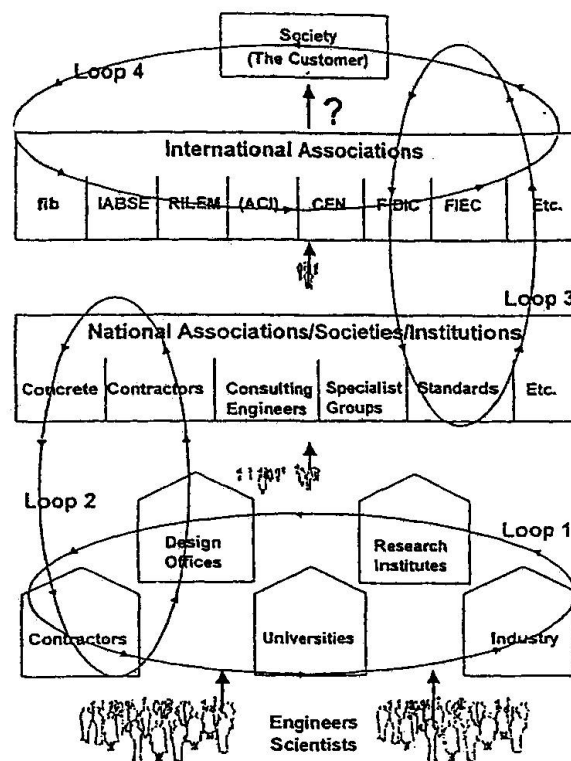

Fig. 2 Concrete networks(10)

Sheikh et al. (12) discussed the advantages of using fiber reinforced plastics (FRP) for construction, strengthening and repair from the technical as well as the economical point of view. As the advantages of FRP, high strength-to-weight ratio, much better fatigue performance, ease of transport and installation, low maintenance cost, durable, minimum disruption of structure use during rehabilitation, no measurable loss of overhead or side clearance were raised. Many applications of FRP to beams, columns, slabs, and walls were reviewed. From their own tests, it was found that the response of the FRP-repaired specimen resulted in much larger energy dissipation. The economical advantages of using CFRP was also concretely shown.

Ueda (13) described that the 21th century is the century in which infrastructure has been constructed and stocked, the 21st century, however, is the century in which we will be asked how to hand the infrastructure as the property of human being to the next generation, and retrofitting seems to be the best solution for that. He introduced the performance-based design system for retrofitting proposed by Sub-Committee on Retrofitting Design of JSCE Concrete Committee, in which design methods for major retrofitting methods, such as external cable method, wrapping (or jacketing) method and concrete wrapping (or jacketing) method, were shown for the first time. The retrofitting design method consists of (a) investigation of existing structure, (2) examination of performances of existing structure, (3) selection of retrofitting method, and (d) examination of performances in retrofitted structure. It was concluded that further study is still needed especially on how to predict the time dependency of structural performances.

4. Eurocode 2

According to Litzner (14), for the realization of the European single market, the Commission of the European Communities has initiated the work of establishing a set of unified technical rules for the design of building and civil engineering works which will gradually replace the different rules in force in the various EC-Member States. The design concept of Structural Eurocodes are as follows:

1. With acceptable probability, they will remain fit for the use for which they are required,



- having due regard to their intended life and their cost.
2. With appropriate degrees of reliability, they will sustain all actions and influences likely to occur during execution and use and have adequate durability in relation to maintenance costs.

The verification of the performance of concrete structures will be conducted in the following condition:

$$S_d \leq R_d$$

where S_d is actions due to load and environment and R_d is corresponding resistances.

Thus, it may be said that the Eurocode 2 is a partially performance-based design code, because it actually contains many practical descriptive rules. This comes from the fact "the structural Eurocode have to provide the technical tool for their achievement(14)." Although Eurocode 2 does not provide an integrated design approach, performance -based design on durability will be applied to the practical level for the first time. It will be not so difficult to modify the whole framework in due process in the future depending on the development of concrete technologies.

5. ACI Building and ISO Codes

In the JCI Tokyo symposium, Corley (15) addressed a proposed framework for future codes in his paper. As a future format of ACI building codes, the following was proposed:

Chapter X

- X.0 -- Notation
- X.1 -- Scope
- X.2 -- General requirements
- X.3 -- Minimum reinforcement
- X.4 -- Design procedures
 - X.4.1 -- Direct design
 - X.4.2 -- Rigorous design
 - X.4.3 -- Performance design

Direct design is the simple approach with a simple calculator. Rigorous approach mostly the body of ACI 318-95. However, according to his understanding, performance design is limited only by statics, compatibility, and serviceability, in which computer assistance is mandatory. A framework of ISO code on "Performance Requirements for Structural Concrete" was also proposed as follows:

1. Scope
2. General Principles
3. Requirements
 - 3.1 Structural safety, ultimate limit states
 - 3.2 Serviceability limit states
 - 3.3 Durability limit states
 - 3.4 Fire resistance limit states
 - 3.5 Fatigue
4. Criteria

"Criteria shall be established so that resistance exceeds actions by a suitable margin"
5. Assessment
 - 5.1 Material properties/5.2 Analysis of concrete structures/ 5.3 Strength calculations/
 - 5.4 Discontinuity regions/5.5 Bond,anchorage, and splices/5.6 Stability/5.7 Bearing/
 - 5.8 Two-way slabs/5.9 Precast concrete and composite action/5.10 Prestressed concrete/
 - 5.11 Design for earthquake resistance/5.12 Detailing requirements/5.13 Construction requirements/5.14 Quality control
6. Standards Deemed to Satisfy

"Any standard in the following list is deemed to satisfy this ISO Standard:

 1. XXX

2. YYY

For a standard to be added to the list of "deemed to satisfy; it must be approved by letter ballot of ISO TC/71"

It will be valuable to compare this framework and Japanese one on the advantages for the future development of concrete technology.

6. Concluding remarks

We are now in a turning point in the history of design of concrete structures. Technology is the reflection of social system. The drastic change of every systems have been required all over the world. It means that we need to establish a new framework of concrete technologies which meet the requirements from the new sophisticated systems. The level of development in design methods of concrete structures will depend on the comprehensiveness of the design framework. From the above-discussion, the points which we have to direct is quite obvious. The final target is to grasp the performance of a structure as it is. Based on this fundamental concept, the informations on the performance of concrete structures should be steadily accumulated.

7. References

1. K. Sakai(editor):Integrated Design and Environmental Issues in Concrete Technology, E & FN SPON, 1996.
2. O. E. Gjrv and K. Sakai (Editors):Preliminary Proceedings of International Workshop on Concrete Technologies for a Sustainable Development in the 21st Century, Svolvr, Lofoten Islands, Norway, June 24-26, 1998.
3. K. Sakai and N. Banthia: Integrated Design of Concrete Structures and Technology Development, *ibid*.
4. JCI TC961 Committee : Integrated Design of Concrete Structures, JCI, 1998
5. K. Maekawa and T. Ishida: Unification of Thermo-Physics of Materials and Mechanics of Structures - Toward a life span simulator of structural concrete, *ibid*.
6. O.E. Gjrv: Controlled Service life of concrete structures and environmental consciousness, *ibid*.
7. A. Sarja: Integrated Life Cycle Design of Concrete Structures, *ibid*.
8. G. Somerville: A Holistic Approach to Structural Durability Design, *ibid*.
9. P.K. Mehta: Concrete Technology for Sustainable Development - An overview of essential elements, *ibid*.
10. J. Moksnes: The Role of Voluntary International Associations in Promoting a Sustainable Development in Concrete, *ibid*.
11. G. Horrigmo: Future Needs in Concrete Repair Technology, *ibid*.
12. S.A. Sheikh and A. Biddah: Fibre Reinforced Polymers (FRP) as an Economical Alternative for Construction and Rehabilitation, *ibid*.
13. T. Ueda: Retroffiting - An answer for sustainable development in the 21st century, *ibid*.
14. H.-U. Litzner: Eurocode 2 - A concep for structural and durable design, Integrated Design of Concrete Structures, JCI TC961 Committee, 1998.
15. W.G. Corley: Protecting the international public from fools and rascals - ACI & ISO building codes for the millennium