

Flexural behaviour of two-span partially continuous prestressed concrete beam with external tendons

Autor(en): **Atsuhiko, Machida / Chakree, Bamrungwong**

Objektyp: **Article**

Zeitschrift: **IABSE reports = Rapports AIPC = IVBH Berichte**

Band (Jahr): **81 (1999)**

PDF erstellt am: **22.07.2024**

Persistenter Link: <https://doi.org/10.5169/seals-61433>

Nutzungsbedingungen

Die ETH-Bibliothek ist Anbieterin der digitalisierten Zeitschriften. Sie besitzt keine Urheberrechte an den Inhalten der Zeitschriften. Die Rechte liegen in der Regel bei den Herausgebern.

Die auf der Plattform e-periodica veröffentlichten Dokumente stehen für nicht-kommerzielle Zwecke in Lehre und Forschung sowie für die private Nutzung frei zur Verfügung. Einzelne Dateien oder Ausdrucke aus diesem Angebot können zusammen mit diesen Nutzungsbedingungen und den korrekten Herkunftsbezeichnungen weitergegeben werden.

Das Veröffentlichen von Bildern in Print- und Online-Publikationen ist nur mit vorheriger Genehmigung der Rechteinhaber erlaubt. Die systematische Speicherung von Teilen des elektronischen Angebots auf anderen Servern bedarf ebenfalls des schriftlichen Einverständnisses der Rechteinhaber.

Haftungsausschluss

Alle Angaben erfolgen ohne Gewähr für Vollständigkeit oder Richtigkeit. Es wird keine Haftung übernommen für Schäden durch die Verwendung von Informationen aus diesem Online-Angebot oder durch das Fehlen von Informationen. Dies gilt auch für Inhalte Dritter, die über dieses Angebot zugänglich sind.



Flexural Behaviour of Two-Span Partially Continuous Prestressed Concrete Beam with External Tendons

Machida Atsuhiko
Professor
Saitama University
Saitama, Japan

Bamrungwong Chakree
Doctoral Student
Saitama University
Saitama, Japan

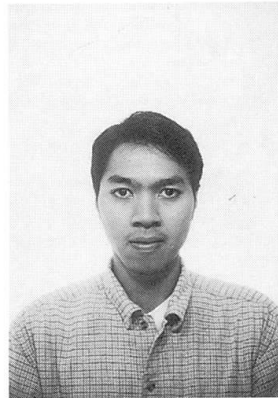

Machida Atsuhiko,
Professor, received his
B.Eng, M.Eng, and D.Eng
degree from University of
Tokyo, Japan.

Bamrungwong Chakree,
received his B.Eng from
SIIT, Thammasat
University, Thailand,
M.Eng(Civil Eng.) from
Saitama University, Japan.

Summary

The objective of this study is mainly to experimentally and analytically investigate the flexural behaviour of the partially continuous PC beams to clarify the existing ambiguous characteristics. The flexural behaviour of two-span partially continuous PC beams is determined in comparison with single-span and two-span monolithically continuous PC beam having same internal prestressing force. The experimental results show that both monolithically and partially continuous PC beams have higher load carrying capacity than single-span PC beam. Nevertheless, compared to monolithically continuous PC beam, the load carrying capacity of all partially continuous PC beams is less, noting that the capacity is increased as the initial prestressing forces in external tendons become larger. Thereafter, a non-linear numerical analysis model is developed based on some basic assumptions to simulate the flexural behaviour of partially continuous PC beams. Satisfactory trends of flexural behaviour of partially continuous PC beams could be predicted by means of computer programming.

1. Introduction

As the existing highway bridges are getting older and higher load carrying capacity is necessary to serve an increasing transportation demand, the need of strengthening of these old bridges is initiated. In this paper the strengthening method for single-span prestressed concrete beams is described. The application of externally post-tensioned tendons is selected to build a continuity on two single-span PC beams owing to its less effort as well as cost effectiveness in construction. Besides, this method can also help improve the riding quality on the bridges, since single-span beams are connected to be continuous type. However, due to some encountered difficulties, for instance, member dependent characteristic of unbonded tendon stress and the rotation of the connection joint, so far, the flexural behaviour of single-span beams strengthened with using such a method is still not clearly understood. This research is, therefore, conducted so as to investigate the real flexural behaviour along with the analytical methodology for predicting the characteristic of strengthened beams. The comparative tests were conducted in order to observe the differences among behaviours of partially continuous, monolithically continuous, and single-span simply supported PC beam. Additionally, as it was expected that the magnitude of external prestressing force would affect the behaviour of partially continuous PC beam, the experimental program was, thus, set up for checking the influence of such a factor as well. In the analytical part, some basic assumptions, such as the beam theory, etc., were initially implemented to simulate the real flexural behaviours of partially continuous PC beams. Based on these assumptions, the flexural behaviour of the beams throughout loading steps until reaching the ultimate stage was analysed by means of computer programming. Lastly, the analytical predictions were brought into comparison with the data collected during conducting experiment and some discussions were then given in the view of load-displacement relationship and the characteristic of force in external tendon.

2. Experimental Methodology

Three partially continuous, one monolithically continuous, and one single-span PC beams having same T-shaped cross section were made in experiment as it was one of the major type of the existing beams. All beams have a similar sectional arrangement. However, for continuous specimens, at the centre support position the shape were altered to rectangular section. In preparation of the test specimens, six single-span PC beams were separately cast. After the main beams were internally prestressed with the force of magnitude equal to 250 kN, the reinforced concrete connection blocks between couples of single-span PC beams were then made. Finally, the coupled beams were firmly connected to each other with external tendons. The dimension of partially continuous PC specimens is shown in Fig.1. Within a group of partially continuous PC beams, the force introduced to external tendons were varied from 80, 160, and 210 kN for specimen number PCB1, PCB2, and PCB3, respectively. The test variables and materials used in making the specimens are given in Table 1. All beam specimens were then tested with two-point loading system of which loading span was set to be 1.3 m. During test, the forces and displacements were measured and collected through the data logger at every 5 kN loading step.

No.	Specimen Description	Reinforcements		Tendon Type	Tendon Force (kN)	Concrete Strength (MPa)
		Longitudinal Bars	Stirrups			
PCB1	Partially Continuous PC Beam I	2D13+2D6(top) 2D13(bottom)	D6@50 D6@90	2-SWPR7A 1-SWPR19	80(ext) 250(int)	31
PCB2	Partially Continuous PC Beam II				160(ext) 250(int)	36
PCB3	Partially Continuous PC Beam III				210(ext) 250(int)	32
MCB	Monolithically Continuous PC Beam			1-SWPR19	250(int)	35
SSB	Single Span PC Beam			1-SWPR19	250(int)	32

Table 1 Materials used and test variables

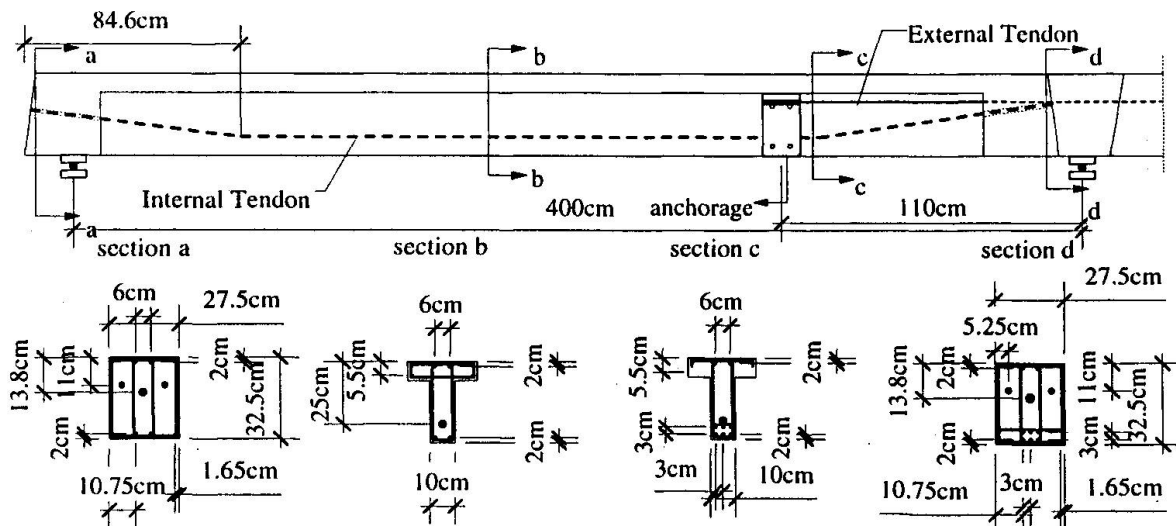

Fig.1 Detailed Design of Partially Continuous PC Beam(Connected Single-Span PC Beams)

3. Experimental Results and Discussions

Having experimentally investigated the flexural behaviour of single-span, monolithically, and partially continuous beams, the relationships between load and displacement at mid-span are plotted as in Fig.2, while the characteristic of force in external tendons of partially continuous PC beams are given in Fig.3. The crushing of concrete in compressive zone had, eventually, taken place at the mid-span section of the continuous beams, except for monolithically continuous case, where such a failure appeared simultaneously at mid-span as well as at centre support.

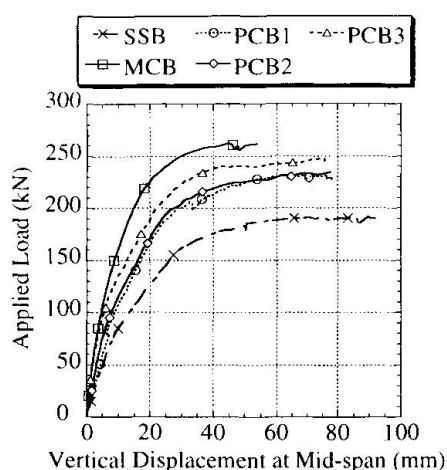

Fig.2 Load-Displacement

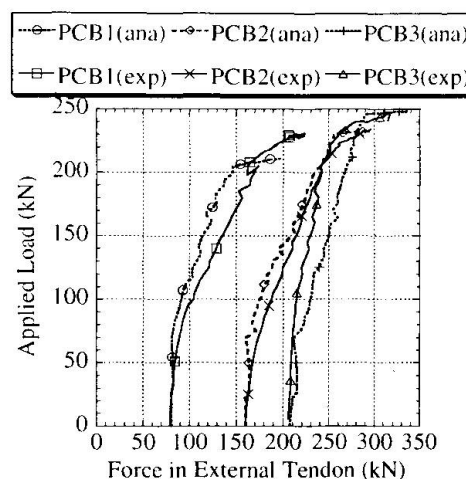

Fig.3 Analytical and Experimental Characteristic of Tendon Force

3.1 Load-Displacement Relationship of Partially Continuous PC Beams

From Fig.2, the relationship between applied load and the vertical displacement at mid-span of partially continuous PC beams, the conclusion could be drawn that specimen PCB3 (with initial prestressing force equal to 210 kN) responded the load in stiffer manner than PCB2 (with 160 kN prestress) and PCB1 (with 80 kN prestress). The rate of change in applied load with respect to displacement response was varied from high to medium, and finally to low for all specimens. The first change in gradient of load-displacement curve could be noticed at the point where applied load was nearly equal to the cracking load of all specimens simultaneously with the opening of joint. That means after cracking the stiffness of beam had been lowered. After the load was further applied, a while later, it was found that the stiffness, again, began to decrease. At this loading stage, the strain in concrete at internal tendon level had been increased until reaching the values that was capable to yield the internal prestressed tendon which led to the yielding of the whole beam. Small increment of applied load caused large deflection to beam compared to a much smaller deflection generated by the same loading increment before tendon was yielded. Finally, from the investigation of load-displacement curves, notice was given that the ultimate strength of specimen PCB3 was higher than PCB2, and PCB1 showed the lowest ultimate load resisting capacity. It should also be noted that though the first crushing had already taken place, the beams still could withstand slightly increasing load in a very ductile manner. Conclusively, the resistance to applied load beyond the point where covering concrete reached its ultimate compressive strength (crushing of concrete in compressive zone), was due to the effect of confining reinforcements which were equally provided in all test specimens.

3.2 Behaviour of Force in External Tendons

The characteristics of forces in external tendons throughout the loading until the ultimate stage are as shown in Fig.3. From the plot, it is noticed that the differences in tendon forces between ultimate and initial stage for specimen PCB1, PCB2, and PCB3 are 142.2, 120.8, and 107.4 kN respectively. Considering these differences in tendon forces, it can be clearly seen that when the force applied initially into tendons is higher, the increment up to the ultimate stage are lower. From Fig.3, the forces in external tendons are, at first, slightly increased. Then at the point where the connection joint starts to open widely, the forces in tendons become progressively intensified. At the same load where internal tendon starts to yield, the forces in external tendons are sharply increased until arriving at ultimate stage.

3.3 Comparative Results on Flexural Behaviour of Partially Continuous PC Beams with Single-Span and Monolithically Continuous PC Beams

It is obvious that the monolithically continuous PC beam has the highest ultimate load carrying capacity followed by set of partially continuous PC beams, and single-span PC beam orderly. The percentage increase in ultimate strength, compared to single-span beam, of PCB1, PCB2, PCB3, and MCB are 21.6, 23.7, 28.9, and 37.4 percent, respectively. From Fig.2, load-

displacement relationships of PCB, MCB, and SSB, it can be deduced that monolithically continuous PC beam shows the stiffest behaviour in resisting load but the lowest ductility. The single-span PC beam behaves in the most ductile manner, however, the least load resisting capacity is provided by this beam. An intermediate behaviour between monolithically continuous and single-span PC beams can be obtained within the group of partially continuous PC beams. As magnitude of prestress in external tendons are increased, the behaviour of partially continuous PC beam will be rather like the monolithically continuous PC beam.

4. Analytical Methodology

Due to the unavailability of the accurate prediction methodology for the flexural behaviour of partially continuous PC beams, an analytical program was developed. The influences of secondary moment, member-dependency characteristics of stress in unbonded tendons, the effect of tendon eccentricity, and the joint rotation at the connection had been incorporated in the analytical procedure. Meanwhile, the non-linear material properties of concrete, steel and tendons were also taken into account to create a reliable model for predicting the flexural behaviour up to the ultimate stage, of partially continuous PC beams. The load-deformation characteristics, and change of stress in unbonded tendons were primarily simulated with the analytical models and later compared with the experimental results.

4.1 Basic Assumptions

A non-linear analysis model based on the fundamental assumptions used for flexural member, was adopted to establish the comprehensive analytical procedure. The assumptions imposed in the analytical model are given as follows,

1. Based on the beam theory, plane sections will remain plane after bending, thus the linear distribution of strain is assumed across the concrete section.
2. The increase of strain in external tendons is uniformly distributed along the entire length of tendon.
3. The deformation of concrete located at external tendon level plus amount of opening at the joint, is equal to the total elongation of the external tendon.
4. Concrete at the joint between main beam and connection block has no resistance to tensile force (dry joint).

4.2 Modelling of Partially Continuous PC Beams

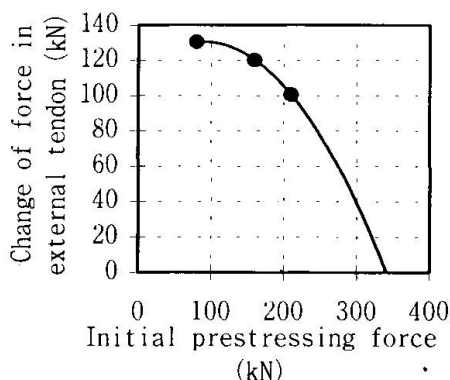

Fig.4 Relationship between Change in Tendon Force and Initial Prestress

Accordingly to the intermediate flexural behaviour of partially continuous PC beams observed in experiment, the model is presumably constructed in order to simulate the corresponding real characteristics. As the load is symmetrically applied on both spans, only left span is extracted out for analysis. At the centre support, unlike the monolithically continuous case, the boundary condition is assumed to be partially fixed, where, $M_{\text{free-end}} < M_{\text{partially-fixed}} < M_{\text{fixed-end}}$. Along with this assumption, at centre support, the beam is also allowed to rotate to some degree. Since only a range of moment at partially fixed end is not adequate for analysing behaviour of the structure, a more specific value of moment is, therefore, assumed to be a function of fixed-end moment ($M_{\text{fixed-end}}$) multiplied by one reduction factor called degree of continuity (D_{cont}). The degree of continuity is proposed as the ratio of initial prestressing force ($P_{\text{ps(initial)}}$) to the ideal prestressing force ($P_{\text{ps(ideal)}}$). The latter is

presumably considered as the force that is sufficient to make no rotation at centre support, or the prestressing force which can make the flexural behaviour of partially continuous PC beam resemble to that of monolithically continuous one. Therefore,

$$M_{\text{partially-fixed}} = D_{\text{cont}} M_{\text{fixed-end}}$$



$$D_{\text{cont}} = P_{\text{ps}(\text{initial})} / P_{\text{ps}(\text{ideal})}$$

The change of force in external tendon is assumed to be a function of size of opening at connection joint. Thus if the partially continuous PC beam is prestressed with the ideal prestressing force, as assumed, the change of force in external tendon from initial to the ultimate stage should be approximately equal to zero. From the plot of experimental data in Fig.4, the ideal prestressing force is determined to be equal to 360 kN. After having defined the analytical model, the behaviour of partially continuous PC beam through loading steps until reaching the ultimate stage (crushing of concrete in compressive zone) is consecutively analysed by means of computer program developed in FORTRAN language. The main contents of the program are algorithmically explained in the following flowchart.

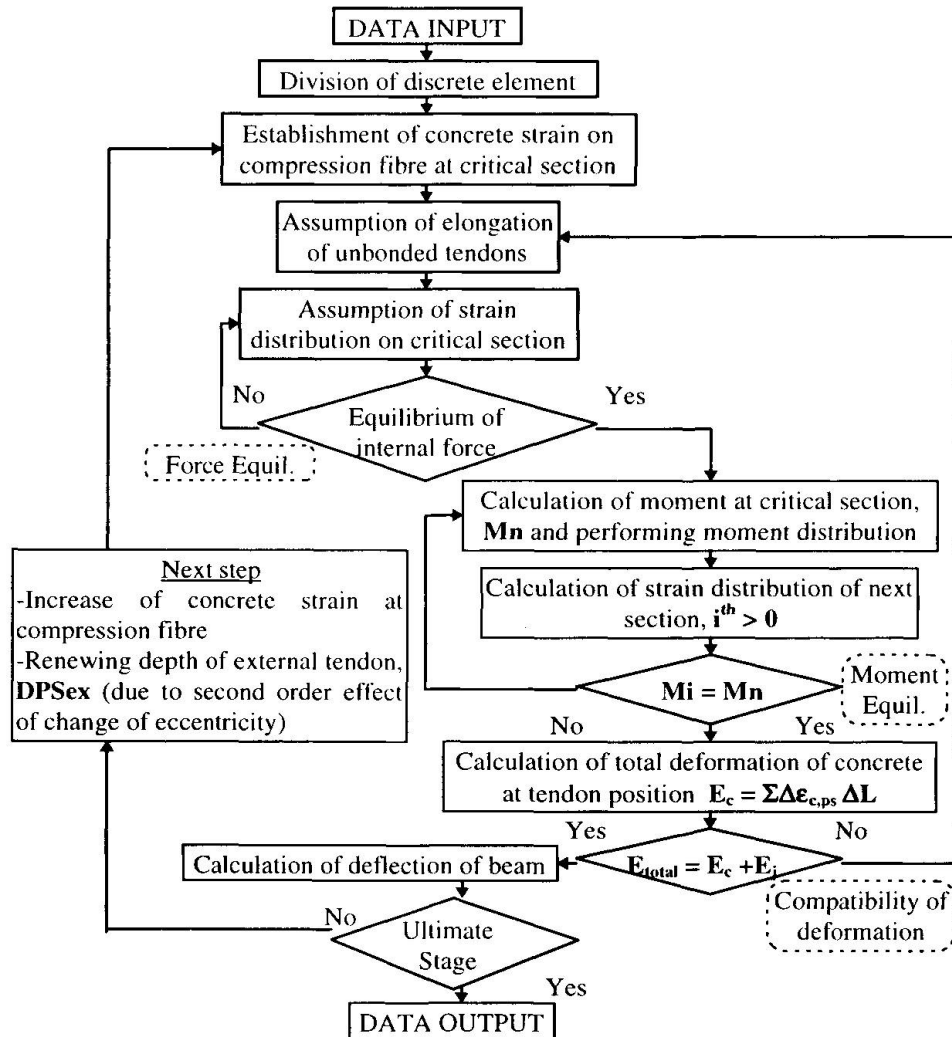

5 Comparison between Experimental Results and Analytical Predictions

To the flexural behaviour of partially continuous PC beams observed in the experiment, the analytical results which are based on some assumptions mentioned previously are compared, and discussed in the view of load-displacement characteristic along with the behaviour of forces in external tendons.

5.1 Load-Displacement Characteristics

From the comparative plots in Fig.5, conclusion can be drawn that, the analytical results show good agreement with the experimental ones up to a certain loading stage, which in all cases of partially continuous PC beams is the loading stage before the occurrence of joint opening. It is because before reaching such a loading stage, the beams still behave elastically. The assumptions used in defining the boundary conditions of partially continuous PC beams are correlatively

applicable. However, beyond the elastic stage, the whole beam loses its stiffness. Strain in external tendons is no longer only dependent on size of opening at joint but also on the deflection of beam. The calculation of moment at centre support is, therefore, not fully correct.

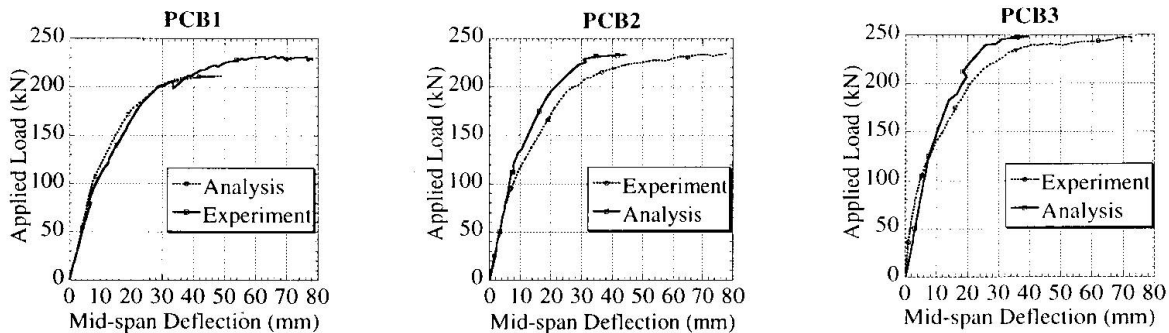

Fig.5 Comparison between Experimental and Analytical Load-Displacement Relationships

5.2 Behaviour of Force in External Tendons

It can be deduced from Fig.3 that, with using the developed program, the trend of change of forces in external tendon are almost correlated with those obtained from the tests. Within the elastic range, the analysed characteristics of force in external tendon show good agreement with the experimental results. Nevertheless, apart from this stage, the forces in external tendons are underestimated for specimen PCB1 and PCB2. But for specimen PCB3 the predicted force is overestimated. The largest errors produced in analysis compared to experimental data along this inelastic stage are 17.2, 7.3, and 11.1 percent in specimens PCB1, PCB2, and PCB2, respectively. The potential reason is also because of the deduction of the applicability of the assumption stating that the change of force in external tendon is a function of the opening size only.

6. Conclusion

Having carried out the experiments and developed the analytical methodology for predicting the flexural behaviour of partially continuous PC beams, the following conclusions could be drawn from the results of this experimental and analytical investigation :

1. As can be observed in experiment, partially continuous PC beams have an intermediate flexural behaviour between those of monolithically continuous and single-span simply supported PC beam.
2. The more intensively the external tendons are prestressed, the more the flexural behaviour of partially continuous PC beam will become closed to that of monolithically continuous PC beam.
3. The degree of continuity (D_{cont}) can be used to determine the specific value of moment at centre support in analysis with a fairly good agreement especially within elastic range.
4. The analytical program is applicable only to this specific type of partially continuous PC beams, since the degree of continuity is derived based on this particular set of experimental results.

References

- [1] Songkiat M., "Flexural Behaviour of Externally Prestressed Concrete Beams", D.Eng. Dissertation, 1995, Saitama University, Saitama, Japan
- [2] R.J.G. MacGregor, M.E. Kreger, and J.E. Breen, "Strength and Ductility of a Three-Span Externally Post-Tensioned Segmental Box Girder Bridge Model", External Prestressing in Bridges, ACI, sp120-15
- [3] Chakree B., "Flexural Behaviour of Two-Span Partially Continuous Prestressed Concrete Beams with External Tendons", Master Thesis, 1998, Saitama University, Saitama, Japan